

# FRAGMENTS AND CLAUSAL ELLIPSIS

A Dissertation Presented

by

ANDREW WEIR

Submitted to the Graduate School of the  
University of Massachusetts Amherst in partial fulfillment  
of the requirements for the degree of

DOCTOR OF PHILOSOPHY

September 2014

Linguistics

© Copyright by Andrew Weir 2014

All Rights Reserved

# FRAGMENTS AND CLAUSAL ELLIPSIS

A Dissertation Presented

by

ANDREW WEIR

Approved as to style and content by:

---

Kyle Johnson, Chair

---

Ellen Woolford, Member

---

Jeremy Hartman, Member

---

Luiz Amaral, Member

---

John Kingston, Head of Department  
Linguistics

*For Jean Brady, 1919–2014*

## ACKNOWLEDGMENTS

As I write this, I'm on a plane flying from Brussels to Charlotte, North Carolina, thence to connect to Bradley International Airport. I'm going to spend a week in Massachusetts, to do a variety of things, one of them being to file this dissertation.

I've got(ten)<sup>1</sup> used to transatlantic flights by now, but my first was just over five years ago, to visit UMass. I didn't know what an adventure that would end up being. Almost none of it can be satisfactorily summarized in these acknowledgments. That said, the acknowledgments are all I've read of most people's dissertations, so I'm aware I should make these good.

As is traditional, let's start with my committee. Kyle Johnson is who I want to be when I grow up. Even during the longest, darkest nights of the soul experienced during the creation of this dissertation, I always knew that meeting with Kyle would drag me out of any depression I was in, partly because he's such a [expletive deleted] cheery fellow who you can rely upon to laugh at your jokes even when they're not funny, but mostly because Kyle knows everything about everything (everything linguistic, anyway). I think in literally every meeting we had, Kyle worked out the solution to some problem I was having, letting me claim the resulting answer as my own. In particular, his protestations that he is an amateur in semantics are clearly lies, which is one reason why a nominally syntactic dissertation has ended up with so much semantics in it. I didn't really ever 'propose' to Kyle to ask him to be my advisor; as I hear often happens, he just sort of assumed the role of chair, in paternal fashion. I am extremely grateful he did.

---

<sup>1</sup>My Scottish friends are fond of noting that, while my accent has remained more-or-less the same, my sojourn in the US has sometimes had effects on my word choice, inflectional morphology, and stress placement.

Ellen Woolford has been my guide in all things syntax/PF-y since the seminar I took from her on the topic. Meetings with her always resulted in clearer, more persuasive, more focused arguments in the dissertation, and on the great number of occasions when I was about to say something that, from a syntactic, morphological, or cross-linguistic perspective, was just silly, she steered me clear of those pitfalls. I'm particularly grateful to her for putting me on to the literature about logophoric contexts, which helped me talk about 'verbs of speech or thought' in chapter 5 in a sensible way. She's also great fun to meet with; like Kyle, I don't think I ever walked out of her office without a smile on my face.

The impact Jeremy Hartman has had on this dissertation should be clear from the number of times the phrase "the below example (from Jeremy Hartman, p.c.)" appears in it. Jeremy's generosity in bequeathing these examples to me – linguists are often very possessive of cool data! – led to this dissertation containing many of the interesting puzzles that it does. (Whether I've solved the puzzles or not is up to the reader.) In particular, the example *Which Brontë sister wrote Emma?* – #Jane Austen started me on a long but fascinating and productive journey (of which much of chapter 3 is the result). But it's not just data Jeremy provided: he also provided many of the probing and challenging questions that encouraged me to make my analysis sharper and clearer. We also had a great time in meetings trying to attack these problems, and once again, I don't think I ever had a frustrating or depressing meeting with him, one of the highest compliments I can pay an advisor. (What a lucky doctoral student I have been in the committee I chose!)

While Luiz Amaral and I did not have the chance to meet regularly to discuss this dissertation, I'm very grateful to him for agreeing to be my outside member, and providing some very helpful feedback and comments at the defense.

I also owe a debt of gratitude to all the other teachers I have had at UMass, in classes and seminars, advising general papers, and in some cases just giving generously of their time when nothing compelled them to: Rajesh Bhatt, Seth Cable, Ilaria Frana, Lyn Frazier,

Lisa Green, Alice Harris, Angelika Kratzer, John McCarthy, Barbara Partee, Joe Pater, Tom Roeper, Lisa Selkirk, and Peggy Speas.

I'm grateful to the various language consultants whose judgments are used throughout this dissertation (following the normal armchair linguist's method of finding them in the office or sending them an email and saying 'Hey, can you say this in your language?'): Magda Oiry and Jérémy Pasquereau (French), Jon Ander Mendia (Spanish), Stefan Keine (German), Sakshi Bhatia and Jyoti Iyer (Hindi), Yelena Fainleib and Aleksei Nazarov (Russian), Anikó Lipták (Hungarian), Hannah Greene (Embedded T-to-C Question English), and more or less everyone in the department (Standard English).

Parts of the material in this dissertation (prior versions of chapter 3) were presented at the Identity in Ellipsis workshop, held at Leiden University in September 2013, and at NELS 44 at the University of Connecticut in October 2013. I'm grateful to the audiences there for comments. In particular I am grateful to Jason Merchant for his comments both in Leiden and during his visit to UMass in April 2014. I also thank Pauline Jacobson for sharing her work (Jacobson 2013) with me.

Liliane Haegeman has been a source of constant encouragement to me over the past five years – even after I ran away to the US. I'm extremely grateful to her for hiring me in the position I currently have at Ghent University; I can't imagine a better place to be moving to from UMass.

From my past, I would like to also thank the teachers (and writers of letters of recommendation!) that helped me get to this point: at Edinburgh, my dissertation advisors Caroline Heycock and Peter Ackema; at UCL, Klaus Abels, Ad Neeleman, and Hans van de Koot.

That's the academic side of the acknowledgments over (well, not really; almost all of the people I'm about to thank offered academic or linguistic advice too at one time or another, but they weren't getting paid for it). Now to the fun stuff. Almost all of my cohort stayed in 311 South College for the entire time I was at UMass. (Now that the Linguistics

department is moving to pastures new, we were in fact its last inhabitants.) They were a great part of the reason why my time at UMass was as enjoyable as it was. Thanks, for insights about linguistics and life, to Minta Elsmann, Claire Moore-Cantwell, Presley Pizzo, Jason Overfelt, and Robert Staubs.<sup>2</sup> Special thanks are due to Robert, Claire and Minta, my fellow erstwhile residents of 40 Grant, for taking me (a clueless immigré from Scotland) under their wing and giving me a roof over my head. And thanks to the others in the Pioneer Valley, UMass linguists and others, who I enjoyed a beer or two with on occasion: Mike Clauss, Hannah Greene, Matt Hine, Nick LaCara, Jon Ander Mendia, Ali Neyers, Yangsook Park, Jérémy Pasquereau, Amanda Rysling, Anisa Schardl, Brian Smith, and Megan Somerday.

Chunks of this dissertation materialized while I was at home in Scotland, and the people that were instrumental in keeping me sane during that process are: Jim, my comrade-in-arms (and Sonic 3) for over twenty years; the residents of THE FLAT, Keshav, Scott and Graeme; Steven and Kirsty, Jamie and Debbie, Craig, Lesley, Lynsey, Katie, Jane, Key, Smill, Graeme and Emma; the Edinburgh lunch-and-linguistics partners in crime, Aya and Numi; and the Red Chumpos and their fellow travelers, comrades Yiannis, Euan, Phil and Neil. Cheers, everybody. The next pint in the Fish (or Duke's Corner, or the Pear Tree, or wherever) is on me.

There are not enough words that I can put in these acknowledgments to thank Sandra and Bryce, my mother and father, for the love, support and trust they have shown in my twenty-eight years. I know that I can count on that love and support wherever I should end up. Thank you, Mum and Dad.

My great-aunt, Jean Brady, passed away just before I defended this dissertation, at the age of 94. 'Great-aunt' sounds like quite a distant relation, which doesn't do justice to how close Jean and I were; she was a constant source of love and joy in my life right until her

---

<sup>2</sup>Those who know who was in my cohort will notice there is a name missing. Those familiar with the structure of dissertation acknowledgment sections will know where to find that name.



passing. I am sorry that she never got to see me finally becoming Dr. Weir, but I am glad that she got to see at least most of the steps on that journey, and I hope I brought at least a little of the happiness into her life that she brought into mine. This dissertation is dedicated to her.

Even if linguistics had been a complete bust for me; even if life in the Pioneer Valley had been otherwise filled with depression, boredom, and awful beer; even if this dissertation had never ended up seeing the light of day; even if any of these counterfactuals had been true, coming to the UMass Linguistics department would have been worth it just to meet Elizabeth Bogal-Allbritten. Elizabeth, you are my best friend, my soulmate, my source of support during the (many) times I didn't think I could do it. And now, I am so happy that we're starting out on a journey together. We're gonna have so much fun.

# ABSTRACT

## FRAGMENTS AND CLAUSAL ELLIPSIS

SEPTEMBER 2014

ANDREW WEIR

M.A. (Hons.), UNIVERSITY OF EDINBURGH

M.A., UNIVERSITY COLLEGE LONDON

Ph.D., UNIVERSITY OF MASSACHUSETTS AMHERST

Directed by: Professor Kyle Johnson

This dissertation investigates the syntactic and semantic properties of *fragments* – utterances which consist of a constituent smaller than a clause. Examples include short answers, such as *What did he eat? — Chips*, as well as cases which do not respond to any overt question; for example, saying *The train station, please* on entering a taxi. I defend Merchant 2004’s proposal that, underlyingly, fragments contain clausal structure: the fragment answer *chips* is elliptical for *he ate chips*, with *he ate* being present in the syntax but unspoken. I argue that challenges to ellipsis-based accounts of fragments can be circumvented by adopting a particular semantic restriction on which clauses are allowed to elide. Building on an analysis by Reich 2007, I argue that elided clauses must stand in a particular relation to Roberts 2012/1996’s Question under Discussion, which I dub QUD-GIVENness.

I also discuss the syntactic properties of fragments. Merchant 2004 argues that fragments are generated by A'-movement to the left periphery. However, I show that by other diagnostics, fragments appear not to have moved. I solve this contradiction by arguing that

fragments do move, but that this movement takes place only at the level of Phonological Form. At Logical Form, the fragment remains *in situ*. It is this ‘split’ which causes some diagnostics for movement to succeed and others to fail.

Finally, the dissertation considers cases of embedded fragments, such as *Who ate the cookies? — I think John*. Fragments can only be embedded in this way under bridge verbs. Following many authors, I assume that bridge verbs embed a double-complementizer or ‘recursive CP’ structure, while other clausal-embedding verbs embed clauses with only one complementizer. I argue that the ‘higher’ complementizer head embedded by bridge verbs is the head which licenses clausal ellipsis. I support this hypothesis by investigating which *wh*-movement structures allow sluicing. I argue that the *wh*-movement structures which allow sluicing are just those which can be argued to have a double complementizer/recursive CP structure, providing evidence for the hypothesis that the ‘higher’ complementizer in these structures is the licenser of clausal ellipsis.

# TABLE OF CONTENTS

	<b>Page</b>
<b>ACKNOWLEDGMENTS</b> .....	<b>v</b>
<b>ABSTRACT</b> .....	<b>x</b>
 <b>CHAPTER</b>	
<b>1. INTRODUCTION</b> .....	<b>1</b>
<b>2. FRAGMENTS: A CASE OF CLAUSAL ELLIPSIS</b> .....	<b>7</b>
2.1 Introduction .....	7
2.2 Arguments for an elliptical analysis of short answers .....	10
2.2.1 Connectivity effects .....	10
2.2.2 Movement effects .....	12
2.3 Arguments for ‘bare’ fragment answers .....	17
2.3.1 Fragments with no syntax: Stainton and ‘out-of-the-blue’ fragments .....	17
2.3.2 Subsententials, but with syntax: Ginzburg & Sag 2000, Jacobson 2013 .....	21
2.3.2.1 Ginzburg & Sag 2000 .....	21
2.3.2.2 Jacobson 2013 .....	22
2.4 Concerns for non-elliptical accounts .....	24
2.4.1 Problems for accounts without clausal structure .....	24
2.4.1.1 Whence the P-stranding generalization? .....	24
2.4.1.2 Subjectless vP fragments .....	29
2.4.2 Problems for Jacobson 2013 .....	31
2.4.2.1 Antecedents which are not questions .....	31

2.4.2.2	Answering embedded questions . . . . .	34
2.4.3	Problems for Stainton . . . . .	38
2.4.3.1	The lack of immobile fragments . . . . .	38
2.4.3.2	The problem of too many salient properties . . . . .	41
2.4.4	Antecedentless fragments . . . . .	44
2.5	Taking stock . . . . .	50
<b>3.</b>	<b>FRAGMENTS AND THE SEMANTICS OF CLAUSAL ELLIPSIS . . . . .</b>	<b>52</b>
3.1	Introduction . . . . .	52
3.2	Issues any elliptical analysis will have to handle . . . . .	52
3.2.1	Which clauses can be antecedents . . . . .	53
3.2.2	What licenses clausal ellipsis . . . . .	55
3.2.3	The problem of presupposition inheritance . . . . .	58
3.3	Previous approaches to the antecedence condition . . . . .	61
3.3.1	Focus-based approaches . . . . .	61
3.3.1.1	Rooth 1992a: contrast condition . . . . .	61
3.3.1.2	Merchant: e-GIVENness . . . . .	63
3.3.2	Question-based approaches . . . . .	67
3.3.2.1	Krifka 2006: background matching . . . . .	67
3.3.2.2	Reich 2007: equivalence between QUD and focus value of elided clause . . . . .	71
3.4	QUD-GIVENness . . . . .	81
3.4.1	Solving the mismatch problem: ‘existentially closing the QUD’ . . . . .	81
3.4.2	Quantificational fragment answers . . . . .	90
3.4.3	Advantages inherited from Reich’s analysis . . . . .	97
3.4.4	Presupposition inheritance and domain restriction . . . . .	99
3.4.5	Functional questions . . . . .	107
3.4.6	The QUD stack . . . . .	114
3.4.7	Interim summary . . . . .	118
3.5	Manipulating the QUD . . . . .	119
3.6	Antecedentless fragments . . . . .	125

3.6.1	'Restricted ellipsis' under e-GIVENness	126
3.6.2	Antecedentless fragments and implicit QUDs	131
3.6.3	Whence the QUD?	133
3.6.4	Fragments used as imperatives	135
3.7	Syntactic isomorphism and antecedentless fragments	141
3.8	Extension to sluicing	155
3.9	Conclusion	163
<b>4.</b>	<b>FRAGMENTS AND THE SYNTAX OF CLAUSAL ELLIPSIS</b>	<b>164</b>
4.1	Introduction	164
4.2	Some challenges to the movement analysis of fragments	167
4.2.1	NPIs: licit fragments or not?	167
4.2.2	<i>Each... the other</i>	171
4.2.3	Predicate fragment answers and inverse scope	172
4.2.4	Bare quantifier phrase answers	173
4.2.5	Particles	174
4.3	Fragments and movement: the explananda	175
4.4	The solution: fragments move at PF, but stay in situ at LF	178
4.4.1	Total reconstruction and movement at PF	178
4.4.2	Exceptional movement	186
4.4.3	Is it really movement?	190
4.4.4	Movement and economy	194
4.5	Islands	199
4.6	Conclusion	211
<b>5.</b>	<b>EMBEDDING FRAGMENTS</b>	<b>213</b>
5.1	Introduction	213
5.2	Embedded fragments are embedded	217
5.2.1	Distinguishing embedded fragments from direct speech	217
5.2.2	Distinguishing embedded fragments from parentheticals	219
5.2.3	Crosslinguistic support for embedded fragments	228
5.3	Restrictions on embedding	231
5.4	Embedded clauses and the size of the left periphery	234
5.5	Syntactic and semantic correlates of a two-complementizer structure	239
5.5.1	Embedded verb-second	239
5.5.2	Pro-form <i>so</i>	241

5.5.3	Embedded speech acts and logophoric contexts .....	242
5.5.4	A remark on verbs of manner of speaking .....	247
5.5.5	Summary .....	249
5.6	Fragments and double complementizers .....	250
5.7	What forms of <i>wh</i> -movement license sluicing? .....	252
5.7.1	Questions .....	254
5.7.2	Relatives .....	257
5.7.3	Unconditionals .....	259
5.7.4	Exclamatives .....	266
5.7.5	Interim summary .....	278
5.8	Extensional questions in sluicing .....	279
5.8.1	The problem: extensional questions allow sluicing .....	279
5.8.2	C1 and embedded questions in non-veridical environments .....	282
5.8.3	C1, embedded questions, and the Answer operator .....	288
5.8.4	When do we expect C1? .....	291
5.9	Interim summary .....	295
5.10	Split CPs, ellipsis, swiping and spading .....	297
5.11	The presence or absence of a complementizer .....	305
5.11.1	Spanish: a very high complementizer .....	306
5.11.2	Hungarian: a low position for ellipsis remnants .....	309
5.12	The licensing of ellipsis and the [E]-feature .....	311
5.13	Some remaining problems .....	323
5.14	Conclusion .....	327
<b>6.</b>	<b>CONCLUSION .....</b>	<b>329</b>
6.1	Main results of the dissertation .....	329
6.2	Directions for further work .....	331
6.3	The end .....	336
	<b>BIBLIOGRAPHY .....</b>	<b>337</b>

# CHAPTER 1

## INTRODUCTION

This dissertation investigates the phenomenon of *fragments* – utterances which are in some sense ‘complete’, and which appear to communicate the same propositional content as a full clause would, but which do not on the surface contain the syntactic structure which a clause does.

- (1)
- a. What did John eat? — Chips.
  - b. Which students were dancing in the quad? — The Germans.
  - c. A coffee, please.
  - d. [Gesturing to an empty chair.]  
An editor of Natural Language Semantics.
  - e. [Remonstrating with a child unsteadily holding a bowl of soup.]  
Both hands!

How are fragments like those in (1) to be represented in the grammar? One view, put forward by (among others) Ginzburg & Sag 2000, Stainton 1998, 2005, 2006a,b, Jacobson 2013, is that they are ‘bare’ constituents, simply DPs (or other categories such as PP, etc.) generated without any accompanying clausal syntax. Another view, the most detailed exposition of which has been presented in work by Jason Merchant (in particular Merchant 2004), is that the above sentences are covertly clausal: that is, they are *elliptical* variants of sentences such as the below.

- (2)
- a. John ate chips.
  - b. The Germans were dancing in the quad.



- c. I would like a coffee please.
- d. That chair is for an editor of Natural Language Semantics.
- e. Use both hands!

In this dissertation, I defend the latter view: that cases such as (1) should be taken as elliptical for clauses such as those in (2).

There exist two main challenges to this view. The first is one put forward by Robert Stainton: fragments are very often produced without an overt linguistic antecedent, as in the (c, d, e) cases in (1). However, ellipsis has often been assumed to require an overt linguistic antecedent. If that is the case, how can cases like these be cases of clausal ellipsis?

The second challenge comes from the observation, made for example by Jacobson 2013, that in some cases fragments have different properties both from their fully clausal counterparts, and from other constructions which have been analyzed as elliptical, such as verb phrase ellipsis. Consider, for example, the contrast below, adduced by Jacobson.

- (3) Which students came to the party?
  - a. John and Bill came to the party, but I don't know if they're students.
  - b. John and Bill did, but I don't know if they're students.
  - c. #John and Bill, but I don't know if they're students.

Why is the fragment case in (3c) infelicitous with the indicated continuation, while the full clausal case in (3a), and the minimally different case in (3b) (only differing from (3c) by the addition of *did*) are not? Jacobson takes the contrast in (3) as indicating that fragments do not have an elliptical source, but are rather 'bare' constituents, which must 'directly' answer an antecedent question.

In chapter 2 of the dissertation, I present evidence (largely drawn from Merchant 2004) that fragments are indeed to be analyzed as elliptical, and argue that problems arise for accounts which assume that this is not so. However, the challenges raised by Stainton and by Jacobson have to be met. I argue that these challenges do not require giving up the idea

that fragments are generated by clausal ellipsis. Rather, in chapter 3 I locate the solution to these challenges in the semantic antecedence condition on clausal ellipsis. I argue that elided clauses need to stand in a particular relation – which I dub QUD-GIVENNESS, after Merchant 2001’s e-GIVENNESS and ultimately after Schwarzschild 1999’s GIVENNESS – with the Question under Discussion (QUD; Roberts 2012/1996). This relation, drawing on a proposal made by Reich 2007, allows for the generation of fragments without a linguistic antecedent, as the QUD is a semantic/pragmatic object, rather than a purely linguistic/syntactic one. It also, I argue, accounts for the contrast in (3). We follow the intuition that fragment answers have to be ‘direct’ answers to the question, but this does not require us to abandon an elliptical analysis for these cases – rather, it tells us something interesting about the semantic antecedence condition on clausal ellipsis. Linking this semantic antecedence condition on clausal ellipsis with the QUD follows in the footsteps of, among others, Ginzburg & Sag 2000, Reich 2007, AnderBois 2010, Collins et al. 2014; in this work, I extend their observations and argue that it can account for a wide range of data.

Having defended a view of fragments in which they are covertly clausal, in chapter 4 I investigate the syntax of the fragments and the clauses which are elided. If fragment cases like (4) below are treated as elliptical, they look like they involve ellipsis of a non-constituent, which in much recent literature on ellipsis has generally been considered not to be possible.

(4) What did he eat? — ~~He ate~~ chips.

To avoid non-constituent ellipsis, Merchant 2004 argues that fragments are generated by a process of movement of the fragment, followed by ellipsis of the clause that the fragment has moved out of, as in (5).

(5) [Chips [<sub>TP</sub> ~~he ate t~~]]

Merchant adduces much evidence in support of a movement analysis of cases like (5); there are many diagnostics which suggest that fragments do indeed undergo movement, A'-movement specifically, and so the correct structure of fragments is as shown in (5).

However, such an analysis faces the challenge that this sort of movement is ungrammatical in English outside of ellipsis, as the ungrammaticality of (6) shows.

(6) What did he eat? — \*Chips he ate.

In addition, I will argue that by certain diagnostics, fragments appear *not* to have moved. I reconcile these two apparently contradictory data sets by arguing that fragments do move, but that this movement takes place only at the level of Phonological Form (PF). It is driven by the need to extract a focused constituent from an ellipsis site at PF. However, at Logical Form (LF), the fragment remains *in situ*. It is this 'split' in where the fragment is pronounced and where it is interpreted which causes some diagnostics for movement to succeed and others to fail. I argue that this analysis also captures the fact that the movement shown in (5) is exceptional, occurring only in elliptical constructions.

The final chapter of the dissertation, chapter 5, discusses the possibility of embedding fragments. If fragments are to be analyzed as clausal ellipsis, then embedded clauses should be able to elide as well as matrix clauses. I argue that that is correct, on the basis of the grammaticality of cases such as the below.

(7) What did John eat?

a. Mary {thinks/believes/was told/suspects/said} the cookies.

However, not all verbs which embed clauses allow fragments to be embedded below them in the way shown in (7), as (8) shows.

(8) What did John eat?

a. \*Mary {whispered/sighed/quipped} the cookies.

b. ??Mary {found out/confirmed} the cookies.

- c. \*Mary {is proud/is surprised} the cookies.

I argue that this contrast provides information about the syntactic licensing of ellipsis. Specifically I assume, following many authors, that the verbs in (7) embed a type of clause which is different from the clauses embedded in (8). The clauses embedded in (7) are ‘bigger’, in the sense that they contain a clausal left periphery (or complementizer domain) which is syntactically more complex, and contains more heads than the left peripheries of clauses like those embedded in (8). In particular, I argue that it is the presence of a double-complementizer or ‘recursive CP’ structure, and specifically a ‘higher’ complementizer head – which verbs like *say*, *think*, *believe* in (7) embed, but which the verbs in (8) do not – which licenses clausal ellipsis. I support this hypothesis by investigating which *wh*-movement structures allow sluicing (clausal ellipsis with a *wh*-word remnant, as in *Someone left but I don’t know who*). I argue that the *wh*-movement structures which allow sluicing are just those where it can be argued that a double-complementizer/recursive CP structure is present. If a *wh*-movement structure only embeds a single-complementizer structure, it cannot undergo clausal ellipsis, because it lacks the ‘higher’ complementizer head which licenses ellipsis.

A caveat is in order before we proceed. When I refer to ‘fragments’ in this dissertation, I mean to refer to almost all cases of constituents uttered without accompanying clausal syntax – but not quite all. There are some cases which I will systematically exclude (see also Merchant 2004:731f. for a similar list).

- (9)
- a. Interjections: *ouch!*, *oops!*, *damn!*, *shit!*, *for god’s sake!*
  - b. Titles: *Gone with the Wind*, *The Times*, *Linguistic Inquiry*, *A dissertation presented to the Graduate School of the University of Massachusetts Amherst*
  - c. Greetings and other set phatic phrases: *hello*, *goodbye*, *bon appétit*, *congratulations!*
  - d. Onomatopoeia: *bang!*, *too-whoo!*, *woof!*

- e. Cases of ‘labeling’: *Ingredients: potatoes, sunflower oil, salt. Danger: high voltage!*
- f. Vocatives: *Hey, Andrew!, You with the red hair!, Corporal!*

These I take to be genuine cases of subsententials, without clausal syntax. As far as I am aware, there is not much evidence, if any at all, that clausal syntax is involved in these subsententials. So this work does not attempt to defend the strongest possible hypothesis that *all* subsententials result from ellipsis. Given the admission that cases like (9) probably do not involve clausal syntax, we might think (following Occam’s Razor) that the cases which this dissertation does investigate – those in (1) – should be given a non-clausal analysis. That’s a reasonable null hypothesis; my first task, which I address in the following chapter, is to argue that this null hypothesis is wrong. I argue, following Merchant 2004, that cases like (1) should indeed be analyzed as cases of clausal ellipsis.

## CHAPTER 2

### FRAGMENTS: A CASE OF CLAUSAL ELLIPSIS

#### 2.1 Introduction

Consider a question like (10).

(10) Who ate the last cookie?

There are a number of ways of answering this question. One can answer it with a fully clausal answer, as in (11a), or with a short answer as in (11b). One can also answer it with an answer (either clausal or short) embedded under another verb, as in (11c, d). It is also possible to answer the question rather more indirectly, as in (11e).

- (11)
- a. John ate the last cookie.
  - b. John.
  - c. I think John ate the last cookie.
  - d. I think John.
  - e. Well, John's been looking awfully guilty lately.

(11a–d) are all clearly in some sense ‘direct’ answers to the question in (10), while (11e) has to be pragmatically construed as an answer following Gricean principles: we construe the answer in (11e) as being somehow relevant to the discourse, and the most obvious way in which it could be relevant is as a hint that John might be the culprit. In what follows, I will largely disregard ‘indirect’ answers of the form in (11e), and will focus instead on what the alternation between clausal answers (11a, c) and short answers (11b, d) can tell us.

One account of the alternation between (11a, c) and (11b, d) is that short answers are *elliptical* for clausal answers; short answers are versions of clausal answers where most of the material, except for the focused component (intuitively, the answer to the question), goes unspoken. So the alternation between short answers and their clausal counterparts would be simply two different surface realizations of the same underlying form, in the same way as other forms of ellipsis such as VP ellipsis (12b) and sluicing (12c) have been argued to be.<sup>3</sup>

- (12) a. Who ate the last cookie? — John ~~ate the last cookie~~. (fragment)  
 b. Who ate the last cookie? — John did ~~eat the last cookie~~. (VP ellipsis)  
 c. Someone ate the last cookie, but I don't know who ~~ate the last cookie~~.  
 (sluicing)

On an elliptical analysis, fragment answers are essentially the same process of clausal ellipsis as is involved in sluicing. This proposal has its most extended defense in the work of Jason Merchant, in particular Merchant 2004. In this proposal, a focused constituent – the short answer – raises to a position in the left-periphery of the clause. The rest of the clause then elides. Merchant's syntactic implementation of this is the same as in his work on sluicing (Merchant 2001): the left-peripheral head which attracts the fragment (*wh*-word in sluicing) to its Spec is endowed with a particular feature [E], which licenses the non-pronunciation of its complement.<sup>4</sup> The notion that ellipsis-licensing is the property of a particular head originates in Lobeck 1995, and has been further developed by Lobke

---

<sup>3</sup>Here, and throughout this dissertation, I reserve the term 'ellipsis' for cases of unpronounced syntactic structure, which is a slightly stricter definition than that which is usually used. Null pro-forms without internal structure would not come under this rubric, for example. I assume that (at least) VP ellipsis and sluicing do involve structurally present material which goes unpronounced, rather than e.g. null pro-forms, *pace* Chao 1987, Hardt 1993, Lobeck 1995 a.o.; this will be discussed in more detail below.

<sup>4</sup>This is a slight oversimplification of Merchant's syntax for fragments. In fact Merchant has the fragment move again to a position higher than the Spec of the [E]-bearing head, for reasons which are orthogonal to our concerns here.

Aelbrecht (Aelbrecht 2009, 2010). I provide examples of Merchant’s approach to fragment answers below.

(13) a. Who ate the last cookie? — John.

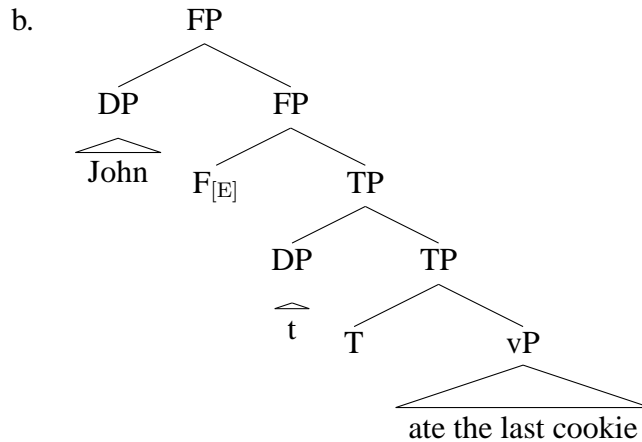

(14) a. What did you eat? — Natto.

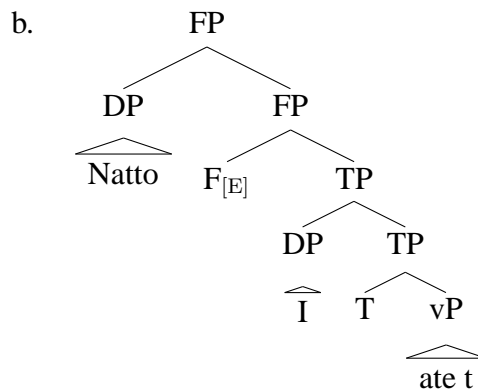

This ‘movement-plus-ellipsis’ approach, where a constituent is moved to a left-peripheral position outside of the domain of clausal ellipsis, has also been adopted for other phenomena which look like they involve ellipsis of most of a clause leaving a few focused remnants, such as for *why*-stripping (*John ate natto. Why natto?*) by Yoshida et al. 2013 (see also Weir to appear) and for so-called ‘non-constituent coordination’ (*John met with Mary on Tuesday and Bill on Wednesday*) by Sailor & Thoms 2014. Stripping (*John met with Mary, but not Bill*) might plausibly also come under this rubric.



## 2.2 Arguments for an elliptical analysis of short answers

The extent to which an elliptical account (one in which clausal structure is present but goes unpronounced) is tenable for fragment answers (as well as sluicing, *why*-stripping and non-constituent co-ordination) depends on evidence for the presence of that clausal structure. Much such evidence has been provided for all of these cases. As the status of short answers as elliptical is more controversial than it is for cases such as sluicing or *why*-stripping, I will concentrate here on presenting Merchant 2004's arguments that fragment answers show properties of containing elliptical clausal structure. Similar arguments have been made for sluicing (Ross 1969, Merchant 2001), *why*-stripping (Yoshida et al. 2013), and non-constituent coordination (Sailor & Thoms 2014), and the reader is referred to these works and references therein for these arguments. I present two main sorts of evidence presented by Merchant for clausal syntactic structure within fragment answers: connectivity effects, and constraints on movement.

### 2.2.1 Connectivity effects

Merchant points out that in languages with clearly expressed morphological case, the case of a fragment answer is the same as the case which it would bear in a full, non-elliptical utterance. This parallels Ross 1969's demonstration of the same facts for sluicing.

(15) *Greek* (Merchant's (45, 46))

- a. Pjos idhe tin Maria? — O Giannis. / \*Ton Gianni.  
who.NOM saw the Maria — the Giannis.NOM / the Giannis.ACC  
'Who saw Maria? — Giannis.'
- b. Pjon idhe i Maria? — \*O Giannis. / Ton Gianni.  
who.ACC saw the Maria? — the Giannis.NOM / the Giannis.ACC  
'Who did Maria see? — Giannis.'

(16) *German* (Merchant's (49, 50))

- a. Wem folgt Hans? — Dem Lehrer. / \*Den Lehrer.  
who.DAT follows Hans — the.DAT teacher / the.ACC teacher  
'Who is Hans following? — The teacher.'
- b. Wen sucht Hans? — \*Dem Lehrer. / Den Lehrer.  
who.ACC seeks Hans — the.DAT teacher / the.ACC teacher  
'Who is Hans looking for? — The teacher.'

(17) *Sluicing in German* (Merchant's (10) after Ross 1969)

- a. Er will jemandem schmeicheln, aber sie wissen nicht, { \*wer /  
he wants someone.DAT flatter, but they know not who.NOM  
\*wen / wem }.  
who.ACC who.DAT  
'He wants to flatter someone, but they don't know who.'
- b. Er will jemanden loben, aber sie wissen nicht, { \*wer / wen  
he wants someone.ACC praise, but they know not who.NOM who.ACC  
/ \*wem }.  
who.ACC  
'He wants to praise someone, but they don't know who.'

The fact that fragments obligatorily appear in a particular Case, Merchant argues, shows that a Case assigner must be present in the structure of the fragment answer, although elided. Merchant also suggests that English possessive fragments also show similar matching effects:

(18) (Merchant's (53))

Q: Whose car did you take?

- a. John's.  
b. \*John.

I think this data, however, is not strictly speaking to do with morphological case; it speaks more to the fact that, in English, possessive-marked DPs cannot move to the exclusion of the rest of the DP that they are in construction with, and force pied-piping (cp. *\*Whose did you take car?*, *\*Who did you take 's car?*). (18a) represents pied-piping of the fragment *John's car*, with NP ellipsis of *car* licensed by the possessive marking. This is still, however, an argument for the movement analysis (on a par with the so-called 'P-stranding generalization', to be discussed below); the fact that fragments apparently obey restrictions on when material must be pied-piped suggests that movement is involved in the derivation of fragments (and, therefore, that there is underlying structure).

As well as case connectivity effects, Merchant also points to binding connectivity facts. Fragment answers are not licit, for example, if the corresponding non-elliptical utterance would contain a violation of principles of binding theory.

(19) a. *Principle C* (Merchant's (57))

Where is he<sub>2</sub> staying? — *\*In John<sub>2</sub>'s apartment. / \*He<sub>2</sub> is staying in John<sub>2</sub>'s apartment.*

b. *Principle B* (Merchant's (59))

Who did John<sub>1</sub> try to shave? — *\*Him<sub>1</sub>./\*John<sub>1</sub> tried to shave him<sub>1</sub>.*

Again, Merchant argues that this shows that there is hidden structure present in fragment answers, and it is that structure which requires the principles of binding theory to be respected.

### 2.2.2 Movement effects

Merchant provides a range of data to support the generalization that it is all and only those constituents which can move in a given language which can be fragment answers in that language. An important argument is the so-called P-stranding generalization (originally presented in Merchant 2001). Languages which allow preposition stranding also allow prepositions to be omitted in fragment answers. However, languages which do not

allow preposition stranding – languages in which prepositions are obligatorily pied-piped under movement – also do not allow the omission of prepositions in fragment answers. (20) shows two examples Merchant gives of English (allowing P-stranding) and German (not allowing P-stranding), but Merchant provides many more.

- (20) a. Who was Peter talking with? — Mary. / With Mary.  
 b. Mit wem hat Anna gesprochen? — Mit dem Hans. / \*Dem Hans.  
 with whom has Anna spoken — with the Hans / the Hans  
 ‘Who did Anna speak to? — Hans.’

On this basis, Merchant concludes that fragment answers must be created by movement; in P-stranding languages, fragment answers may omit prepositions because they may be stranded in the ellipsis site, while languages in which the preposition must pied-pipe must also express the preposition in the answer, suggesting that the prepositional phrase has moved.

Other examples show that if a constituent cannot move in the full clausal structure, it also cannot serve as a fragment answer. For example, consider the below:

- (21) a. (Merchant 2004’s (89), adapted)  
 Did Abby vote for a *Green Party* candidate?  
 (i) \*No, Reform Party. (= Reform Party ~~she voted for a t candidate~~)  
 (ii) No, a Reform Party candidate. (= A Reform Party candidate ~~she voted for t~~)
- b. (Merchant’s (137), adapted)  
 What should I do with the spinach?  
 (i) \*Wash. (= Wash ~~you should t it~~)  
 (ii) Wash it. (= Wash it ~~you should t~~)
- c. What kind of car does he drive?  
 (i) ??Red. (= Red ~~he drives a t car~~)

(ii) A red one. (= A red one ~~he drives t~~)

In (21a), the fragment is a noun being extracted from a noun-noun compound, which is impossible in English. The focused phrase *Reform Party* has to pied-pipe the whole DP *a Reform Party candidate* to a position outside of the ellipsis. Similarly in (21b), extraction of a (bare) verb is impossible in English, and also impossible in fragment answers, which require pied-piping of the entire VP. In (21c), an adjective is being extracted from a prenominal position, which is similarly impossible; again, pied-piping of the entire DP is required. Note that if the adjective is in predicative position (from which extraction is possible), it can be a fragment answer unproblematically (see section 4.5, and Barros et al. to appear, for further discussion of facts like these).

(22) What color is his car? — Red. (= Red ~~it is t~~)

It is also true that, for example, English VPs (which can move) can be fragment answers, but finite TPs (which cannot move) cannot be.<sup>5</sup>

(23) VPs can move and finite TPs cannot:

- a. (He said he would make curry, and) [VP make curry] he should t.
- b. (John will make curry, and) \*[will make curry] Mary t, too.

(24) VPs can be answers and finite TPs cannot:

- a. What will you do then? — Go to the beach ~~I will t~~.
- b. What will you do then? — \*Will go to the beach ~~I t~~.

---

<sup>5</sup>There is a complication with some examples like (24b), noted by Merchant 2004. Some cases which appear to be finite TP fragments do seem to be licit: *What's your problem? — Haven't been feeling very well lately.* Weir 2012, following Napoli 1982, analyzes such cases as not elliptical, or at least not elliptical in the sense of ellipsis as discussed here: rather, they arise from a phonological process of left-edge deletion of weak syllables, to comply with Selkirk 2011's STRONGSTART constraint. There are also interesting questions concerning the grammaticality of cases like (24b) in 'reduced written register' (diaries, text messages, internet, etc.); discussing such cases is beyond the scope of this dissertation, but see Haegeman 1997, 2007, Haegeman & Ihsane 2001, Weir 2012, and references cited therein for discussion.

Merchant notes further that control infinitivals can (marginally) move, but raising infinitivals cannot (an observation attributed to Chomsky 1981:62); Merchant points out that this contrast also carries over to fragment answers. (25) and (26) are adapted from Merchant 2004:696ff.; the judgments are mine.

- (25) a. Immobility of raising infinitivals
- (i) (People don't often simply stop writing, but) \*to procrastinate, people do tend.
  - (ii) (Mary seemed to be well, but) \*to be sick, JOHN seemed.
- b. Impossibility of raising infinitival fragment answers
- (i) How do people tend to behave? — \*To procrastinate.
  - (ii) How did John seem? — \*To be sick.
- (26) a. Mobility of control infinitivals
- (i) (Mary wants to *move* to Europe, but) ?to get a job in Europe, she doesn't want.
  - (ii) (It's not retiring early that Mary wants,) ?it's to get a job in Europe that Mary wants.
- b. Possibility of control infinitival fragment answers
- (i) What does she really want? — To get a job in Europe.

Merchant also notes the following interesting contrast, originally due to Morgan 1973. It is possible to answer a question which seeks an answer of propositional type, as in (27), both with a sentence containing a complementizer and one without it:

- (27) What are you arguing in this section?
- a. Fragment answers are elliptical structures.
  - b. That fragment answers are elliptical structures.

However, if the speaker does not actually agree with the embedded proposition, then the complementizer cannot be omitted. Merchant gives the example below: clearly the speaker here cannot believe the given answer, as no-one can assert ‘I am taller than I really am’. In such an answer, the complementizer cannot be omitted, although in the full clausal structure, this is unproblematic.

(28) (Merchant’s (93, 94))

- a. What does no-one believe? — #(That) I’m taller than I really am.
- b. No-one believes (that) I’m taller than I really am.

Merchant points out, however, that left-dislocated CPs obligatorily contain a complementizer.

(29) (Merchant’s (95))

- \*(That) I’m taller than I really am, no-one believes.

Merchant takes the obligatoriness of the complementizer in fragment answers as further evidence for a left-dislocation analysis: the requirement to have a complementizer is parallel between the left-dislocation and the fragment cases. (I presume that an answer like (27a) is simply not a fragment or elliptical – it is just an assertion by the speaker of one of their beliefs, which is then pragmatically construed via Gricean principles of Relevance as relevant to the question at hand.)

All of these parallelisms constitute strong syntactic evidence for a clausal ellipsis account of fragment answers.<sup>6</sup> However, many researchers have taken issue with the clausal ellipsis analysis on semantic grounds: there are areas where fragment answers seem to pattern differently from full clausal answers with regard to their interpretation, which is not

---

<sup>6</sup>Merchant presents some other arguments, for which I refer the reader to Merchant’s paper. I believe that some of Merchant’s arguments, which I have not presented in this section, do not in fact go through, but I also believe that this does not speak against a movement analysis as such. Rather, I think that this tells us something interesting about the movement which is taking place in these cases. These cases will be discussed at much greater length in chapter 4.

immediately expected if the fragment case is elliptically derived from the clausal case. In the next section, I will present some arguments that have been made in favor of approaches in which fragment answers are not derived elliptically.

## 2.3 Arguments for ‘bare’ fragment answers

### 2.3.1 Fragments with no syntax: Stainton and ‘out-of-the-blue’ fragments

In various papers, Robert Stainton has argued against an elliptical account of fragments. (Stainton 1998, 2005, 2006a,b, a.o.) The chief argument throughout these papers has been that ellipsis is generally considered to require a linguistic antecedent (it is a surface anaphor in Hankamer & Sag 1976’s terms). So, for example, VP ellipsis such as the below is usually considered to require previous linguistic material to be licensed<sup>7</sup>; it cannot be licensed extra-linguistically by reference to the context (in contrast to an anaphor like *do it*, as Hankamer & Sag point out).

(30) (Hankamer & Sag’s (6))

a. [Sag produces a cleaver and prepares to hack off his left hand]

Hankamer: #Don’t be alarmed, ladies and gentlemen, we’ve rehearsed this act several times, and he never actually does.

b. [Same context]

Hankamer: ... He never actually does it.

---

<sup>7</sup>But there is considerable debate about this; Hankamer and Sag’s claims were initially challenged by Schachter 1977 on the basis of apparently acceptable out-of-the-blue cases, like *Shall we?* as an invitation to dance, or *Don’t!* as a general-purpose prohibitive. Pullum 2000 argued that these cases were very restricted in their distribution, and should be seen as lexicalized idiomatic exceptions: the generalization was that VP ellipsis did really require a linguistic antecedent. More recently, however, Miller & Pullum 2013 have suggested that VP ellipsis actually *can* have extra-linguistic/contextual antecedents, but that there are heavy restrictions on the discourse conditions required to license this. I won’t attempt to add much to this debate at least as far as VP ellipsis is concerned, restricting my attention to clausal ellipsis.



The case of sluicing, clausal ellipsis, also often appears to require linguistic antecedents. . .

- (31) a. [I see someone in the distance playing the bagpipes.]  
      ??Who?/I wonder who? (intended: Who is that?/I wonder who that is?)
- b. [I see a beautifully wrapped gift waiting at my front door.]
- (i) ??Who?/I wonder who? (intended: Who sent this?/I wonder who sent this?)
- (ii) ??What?/I wonder what? (intended: What is this?/I wonder what this is?)

. . .but this is not completely clear, as examples like (32) show (see also discussion in Ginzburg 1992 and Chung et al. 1995).

- (32) a. [I knock at the door.] Guess who?<sup>8</sup>
- b. [Disasters have befallen me.] Why, God, why?
- c. [I see someone trying to fix their car engine, and failing.] He doesn't know how.
- d. [Someone gets into my taxi.] Where to, guv?<sup>9</sup>

In any case, however, the fact that ellipsis often requires a syntactic antecedent has been taken by Stainton as an argument against ellipsis being involved in the derivation of fragments. Stainton argues that antecedentless fragments seem not just possible but rather frequent in naturally-occurring data, and so (the argument goes) fragments should not be generated by ellipsis (at least not solely; Stainton acknowledges that in answers to (direct) questions, an elliptical source may be possible). Examples of the sorts of antecedentless fragments that Stainton has in mind, taken from his various papers on the topic, are given below.

---

<sup>8</sup>The title of Ross 1969.

<sup>9</sup>This is a case of sluicing plus a preposition, so-called 'swiping': see e.g. van Craenenbroeck 2004, 2010b, Hartman & Ai 2007.

- (33) a. [On getting into a taxi.] (To) the train station, please.  
 b. [A & B are at a linguistics workshop. There is an empty chair. A nods at it and raises his eyebrows at B. B says:]  
     An editor of Natural Language Semantics.  
 c. [A child spooning out jam at the breakfast table.] Chunks of strawberries.  
 d. [The child in (c)'s mother replying.] Rob's mom.  
 e. [On hearing a strange sound.] The *nyo-gyin*, the song of mourning.  
 f. [Admonishment to a child holding a bowl of soup insecurely.] Both hands!

Merchant 2004 provides similar examples of the type (his (2, 3)).

- (34) a. Abby and Ben are at a party. Abby sees an unfamiliar man with Beth, a mutual friend of theirs, and turns to Ben with a puzzled look on her face. Ben says:  
     “Some guy she met at the park.”  
 b. Abby and Ben are arguing about the origins of products in a new store on their block, with Ben maintaining that the store carries only German products. To settle their debate, they walk into the store together. Ben picks up a lamp at random, upends it, examines the label (which reads *Lampenwelt GmbH, Stuttgart*), holds the lamp out towards Abby, and proudly proclaims to her:  
     “From Germany! See, I told you!”

These fragments do not have linguistic antecedents and yet are licensed. On the basis of such data, Stainton argues that subsentential utterances of this sort are directly generated, without clausal structure. These utterances simply denote what their constituent components denote. For example, an utterance like *An editor of Natural Language Semantics* simply denotes the generalized quantifier given in (35b).

- (35) a. An editor of Natural Language Semantics.  
 b.  $\lambda P_{\langle et \rangle} . \exists x . P(x) \ \& \ x$  is a NALS editor

However, these utterances appear to communicate some form of propositional meaning.<sup>10</sup> How is propositional meaning retrieved? Stainton’s proposal is that there will be certain salient or manifest properties or objects, which are not considered by the speaker or hearer in English or whatever natural language they are speaking, but rather only at the level of the ‘language of thought’, Mentalese. In the case of a manifest property, these can be represented as functions which combine with the denotation of subsententials by function application. A concrete example is the case of *An editor of Natural Language Semantics* (while looking at an empty chair at a meeting). Here, Stainton argues, there is a manifest property, something like THAT CHAIR IS FOR  $\_$ <sup>11</sup>, or in lambda notation,  $[\lambda x. \text{that chair is for } x]$ . This property combines with the denotation of what was actually said, and the proposition that results is what was (understood to be) asserted.

- (36) a.  $[\text{An editor of NALS}] = \lambda P_{\langle \text{et} \rangle}. \exists x. P(x) \ \& \ x \text{ is a NALS editor}$   
 b. Manifest property:  $[\lambda x. \text{that chair is for } x]$   
 c. Composition of the two by Function Application:  
 $[\lambda P_{\langle \text{et} \rangle}. \exists x. P(x) \ \& \ x \text{ is a NALS editor}](\lambda x. \text{that chair is for } x)$   
 $= \exists x. \text{that chair is for } x \ \& \ x \text{ is a NALS editor}$

In this way, subsentential utterances are understood as having propositional meaning (and therefore as being able to be used to perform speech acts like assertion), without that meaning being in any way ‘encoded’ in the fragment itself; the assertion comes from the combination of a manifest property (in Mentalese, not in the object language) with the denotation of the utterance.

---

<sup>10</sup>Stainton 2006b contains some considerable discussion on the question of whether fragments should be understood as encoding/communicating propositional meaning. I won’t recap it here as detailed discussion of these issues is beyond the scope of this dissertation. For our purposes, we will agree – with Stainton and with Merchant – that fragments like those in (34) must somehow be interpreted as communicating the same information as propositions can. The debate centers on how they are so interpreted – whether by positing covert clausal structure, or by another mechanism.

<sup>11</sup>Stainton uses the convention of writing Mentalese in capitals.

### 2.3.2 Subsententials, but with syntax: Ginzburg & Sag 2000, Jacobson 2013

There are alternative accounts which also argue that subsententials are generated without covert clausal structure. However, these accounts do make reference to the properties of syntactic antecedents, in order to capture facts such as the Case connectivity facts. These are accounts such as Ginzburg & Sag 2000's and Jacobson 2013's.

#### 2.3.2.1 Ginzburg & Sag 2000

Ginzburg & Sag 2000 propose an account of subsententials based in the Head-driven Phrase Structure Grammar (HPSG) formalism.<sup>12</sup> In their account, a subsentential is an utterance of type *headed-fragment-phrase* (*hd-frag-ph*). It is not elliptical in the sense of containing deletion; no clausal material is associated with a *hd-frag-ph*. However, a constraint is placed on any phrase of this type, namely that it must match in syntactic category and featural specification with the category and featural specification of an antecedent, denoted as SAL(ient)-UTT(erance). This antecedent is (roughly) the phrase which expresses the questioned constituent within the maximal Question under Discussion (QUD). For example, given an overt interrogative (and QUD) *Who left?*, the SAL-UTT would be *who*. Semantically, the *hd-frag-ph* is co-indexed with SAL-UTT, giving the interpretation of subsententials as answers to the QUD, as below.

- (37) a. Who left? (QUD: who left? SAL-UTT: who)  
b. John. (*John* must match in syntactic features with the antecedent *who* and must be coindexed with it, giving the interpretation that John was the one who left)

The syntactic feature-matching requirement forces Case-matching in cases such as German (repeated here from (16)):

---

<sup>12</sup>I abstract away from details of the implementation here, hoping that in so doing I am not doing violence to Ginzburg & Sag's account. For some more discussion of Ginzburg & Sag's approach, see Merchant 2004.

(38) *German* (Merchant's (49, 50))

- a. Wem folgt Hans? — Dem Lehrer. / \*Den Lehrer.  
who.DAT follows Hans — the.DAT teacher / the.ACC teacher  
'Who is Hans following? — The teacher.'

*Den Lehrer* must match in syntactic features (including dative case) with the antecedent SAL-UTT *wem* 'who.DAT'

### 2.3.2.2 Jacobson 2013

A different account is provided by Jacobson 2013, who proposes that question-answer pairs such as the below are a basic unit of the grammar.

(39) Who left the party at midnight? — Claribel.

In Jacobson's proposed syntax/semantics (based on a Categorical Grammar framework and the semantic framework of Direct Compositionality, Barker & Jacobson 2007 a.o.), this pair represents a syntactic category called 'Qu-Ans'.<sup>13</sup> A Qu is any expression which is a question. An Ans is any category. A Qu-Ans pair is well formed if the Qu contains a *wh*-word of a particular category C, and Ans is also of category C. For example, in (39), the Qu contains *who*, of category NP or DP (depending on theoretical preference); the Ans

---

<sup>13</sup>This is a syntactic category which appears to span utterances and even speakers, which seems unconventional at first blush. Jacobson points out, however, that there is no inherent reason that the grammar should not have something to say about the felicity or grammaticality of syntactically combining two categories into a third even if those two categories are spoken by different people. The idea of combining utterances into a larger grammatical unit has been countenanced elsewhere; e.g. Heim 1982's text-level combination. A problematic case, however (and one that Jacobson notes) is one where the two categories that combine to form a Qu-Ans are not only cross-speaker, but not adjacent:

- (i) (Jacobson's (9))  
A: Who left the party at midnight? Do you know?  
B: Yeah, um... Bill.

It is not obvious how the rules of syntax can combine the Qu here (*Who left the party at midnight*) with an Ans (*Bill*) which is separated from it by intervening material. Jacobson notes this problem, but leaves its solution open.

is *Claribel*, also of category NP or DP, and so (39) is a well-formed member of the category Qu-Ans. The structure is as below.

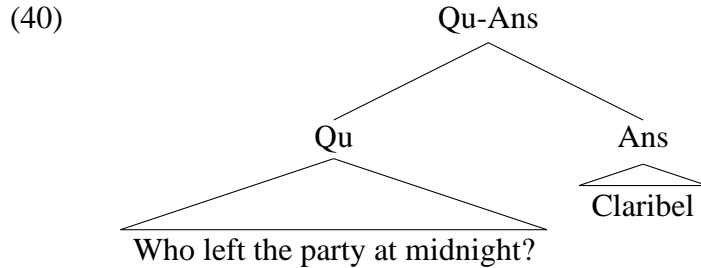

Semantically, Jacobson follows Ginzburg & Sag 2000 (as well as Hausser 1983, Roberts 2012/1996) in analyzing (constituent) questions as lambda-abstractions over the semantic type of the constituent which is being questioned. So, for example, the semantics of the question *Who left the party at midnight?* is given below.

(41)  $\llbracket \text{Who left the party at midnight} \rrbracket = \lambda x.x \text{ left the party at midnight}$

And the semantics of a Qu-Ans pair is simply that of function application:

- (42)
- a. Who left the party at midnight? — Bill.
  - b.  $\llbracket \text{Who left the party at midnight} \rrbracket = \lambda x.x \text{ left the party at midnight}$
  - c.  $\llbracket \text{Bill} \rrbracket = \text{Bill}$
  - d.  $\llbracket \text{Who left the party at midnight} \rrbracket(\llbracket \text{Bill} \rrbracket) = \text{Bill left the party at midnight}$

This works for generalized quantifier answers, as well; the GQ takes the denotation of the question as its argument, rather than vice versa, by type-driven function application:

- (43)
- a. Who left the party at midnight? — Every student.
  - b.  $\llbracket \text{Every student} \rrbracket = \lambda P_{\langle \text{et} \rangle}.\forall x.x \text{ is a student} \rightarrow P(x)$
  - c.  $\llbracket \text{Every student} \rrbracket(\llbracket \text{Who left the party at midnight} \rrbracket)$   
 $= [\lambda P_{\langle \text{et} \rangle}.\forall x.x \text{ is a student} \rightarrow P(x)](\lambda x.x \text{ left the party at midnight})$   
 $= \forall x.x \text{ is a student} \rightarrow x \text{ left the party at midnight}$

## 2.4 Concerns for non-elliptical accounts

All of the non-elliptical accounts of fragments share the property that clausal structure is not present in what is spoken. They therefore also share Merchant's core objection to a non-elliptical account, namely that the effects of clausal structure *do* appear to be present in fragments. For example, as we have seen, Case and binding connectivity effects obtain between the fragment and its antecedent. Furthermore, cross-linguistically, fragments obey the P-stranding generalization: if a particular language forces pied-piping of prepositions, it also forces prepositions to appear in fragment answers.

Ginzburg & Sag 2000's and Jacobson 2013's accounts are designed to handle the Case and binding connectivity effects by encoding a syntactic dependency between the antecedent question and fragment answer – it is just that this dependency does not arise because the fragment answer is covertly clausal, but by some other mechanism. In this section, however, I wish to raise a number of problems for non-elliptical accounts.

### 2.4.1 Problems for accounts without clausal structure

#### 2.4.1.1 Whence the P-stranding generalization?

Non-elliptical analyses of fragments must perforce be non-movement accounts; if there is no elided clause in the structure, the fragment does not therefore move out of that clause. Accounts of clausal ellipsis that do not refer to movement, however, do not give us a handle on the P-stranding generalization, as Merchant 2004, 2010 points out. That is, it is difficult to see why both the P-less and P-ful fragment answers to a question like (44) are good in English, but only the P-ful answer is good in German.

(44) (Merchant 2004's (72, 78), adapted)

- a. With whom was Peter talking? — With Mary. / Mary.
- b. Mit wem hat Anna gesprochen? — Mit dem Hans. / \*Dem Hans.  
with whom has Anna spoken            with the Hans / the Hans  
'Who did Anna speak to? — Hans.'

These facts follow from a movement-plus-ellipsis account of fragments, because English and German have different possibilities for moving DPs which are complements of Ps; the answer *\*Dem Hans* is ruled out in German because the DP could not move to a left-peripheral position without pied-piping the preposition *mit*, and so of the below movement structures, only (45a) is possible.

- (45) a. Mit dem Hans ~~hat Anna t gesprochen~~  
b. *\*Dem Hans* ~~hat Anna mit t gesprochen~~

But it is not obvious what should make the difference between English and German on non-elliptical, non-movement accounts. On accounts of subsententials which are entirely semantic/pragmatic and which involve no syntax at all beyond the syntax of the fragment itself, such as Stainton's account, this is not accounted for: the Mentalese of an English and German speaker should both easily be able to accommodate a manifest property such as ANNA WAS TALKING TO \_ to combine with *dem Hans* in (45b). The preposition should not be required; the DP *dem Hans* should be able to be generated 'bare'. However, it cannot be.<sup>14</sup>

Accounts of subsententials which do make reference to syntax, but not to movement, also have problems capturing the P-stranding generalization. Merchant 2004:669f. makes this point for Ginzburg & Sag 2000's account, by considering Greek examples like the below:<sup>15</sup>

---

<sup>14</sup>Stainton could and does (2006b:97) counterargue that cases with overt questions, such as (44), *do* contain 'true' ellipsis of the type argued for by Merchant 2004 and in the present work; and that the 'Mentalese' mechanism is to be restricted only to cases of antecedentless/'out-of-the-blue' fragments. See 2.4.4 below for discussion of this possibility.

<sup>15</sup>At p. 669, Merchant actually discusses sluicing examples. I have amalgamated this with his later discussion of P-stranding in fragment answers in the same paper (p. 685ff., with (46) being Merchant's (77)), and have made the requisite alterations in material I have quoted from his paper, shown in square brackets.



- (46) a. Me pjon milise i Anna?  
           with whom spoke the Anna  
           ‘With whom did Anna speak?’
- b. Me ton Kosta.  
           with the Kosta.
- c. \*Ton Kosta.

Greek disallows P-stranding, and also disallows an absence of P in a fragment answer. Merchant points out that this does not follow from Ginzburg and Sag’s analysis: ‘nothing prevents [*ton Kosta* in (46)] from being the head of a *hd-frag-ph* whose SAL-UTT value is the *local* value of [*pjon*]’ (p. 669f., emphasis in the original). That is, it is not clear why the syntactic matching requirement imposed on the fragment in (46b) should require a matching with the category of the entire PP, rather than just the DP, in the question.

In fact Ginzburg and Sag (p. 301 fn. 9) do propose to deal with pied-piping by imposing a requirement that the value of SAL-UTT that is chosen should be the most extensive possible, on the basis of the below examples (their judgments indicated):

- (47) a. A: To whom did you give the book?  
           B: #(To) Jo.
- b. A: On what does the well-being of the EU depend?  
           B: #(On) a stable currency.

That is, given a question with pied-piping as in the examples in (47), SAL-UTT must obligatorily be the whole prepositional phrase which is pied-piped, and the requirement that *hd-frag-phs* match in syntactic features and category with SAL-UTT should therefore deliver us the result that pied-piping responses are required if the antecedent contains a pied-piped constituent. However, I have been unable to replicate the judgments shown in (47) with other English speakers. I do not believe there is a contrast between the fragments containing the prepositions and those without, as shown also in (44a). (See Merchant

2004:fn. 8 for a similar observation and discussion of Ginzburg & Sag 2000's proposal in this respect.) The intuitions of the speakers I have consulted are very clear on this point. In fact, to the extent that there is a contrast, the variants *without* prepositions seem better, at least to English speakers I have consulted.<sup>16</sup> It is possible, as Merchant 2004 suggests, that the results reported by Ginzburg & Sag represent a particular dialect of English, one in which pied-piped questions do indeed require pied-piped answers. However, given the existence of speakers for whom that is not the case (that is, for whom *To whom did you give the book?* — *Jo* is acceptable), we cannot generally appeal to a principle of taking the largest available antecedent and requiring it to match in syntactic features with the fragment. Such a principle is clearly not at work for speakers who accept the dialogues in (47). As such, the contrast between English (and other P-stranding languages) and Greek (and other pied-piping languages) remains unexplained.

In fact, it is not clear that there is any general requirement that there be syntactic category matching between an antecedent and a fragment answer at all, as (48) shows.

(48) Did he eat the natto RELUCTANTLY? — No, with relish.

Here, the focused constituent which licenses the fragment is an adverb, but the fragment is a PP; however, the fragment is licensed, even though it does not match its licenser in syntactic category. Furthermore, in some cases there need not even *be* an antecedent that fulfills the role of SAL-UTT; fragment answers can add new information in a way parallel to 'sprouting' cases such as *He ate, but I don't know what* (Chung et al. 2011):

- (49) a. Did he eat? — Yes, natto.  
b. Did he eat natto? — Yes, with relish.

---

<sup>16</sup>This preference could be interpreted as support for the movement analysis of these fragments, to the extent that pied-piping in English is generally the marked option compared to P-stranding.

If there is a requirement that fragments match in syntactic features and category with an antecedent SAL-UTT, then it is not clear how this requirement can hold in cases like (49), where there does not appear to be an antecedent SAL-UTT. On an elliptical analysis, these examples can be handled unproblematically. The syntactic requirements placed on the fragment are imposed by the elided clausal structure, rather than any matching requirement between the fragment and the antecedent; the matching requirement is rather between the *elided clause* and the antecedent.

- (50) a. Did he eat the natto RELUCTANTLY? – No, with relish ~~he ate the natto~~  $\bar{t}$ .  
 b. (i) Did he eat? — Yes, natto ~~he ate~~  $\bar{t}$ .  
 (ii) Did he eat natto? — Yes, with relish ~~he ate natto~~  $\bar{t}$ .

Jacobson’s analysis also does not account for syntactic facts such as the P-stranding generalization. One could imagine that, because a German question such as *mit wem hat Anna gesprochen* ‘with whom did Anna speak’ has a pied-piped PP, it is therefore looking for a specific syntactic category of Ans to combine with. Say that the question is of category Qu/PP, to use a categorial-style slash notation, and that this syntactically rules out combination with a DP like *Dem Hans*. However, if this is the case, then it should equally be true of the English pied-piped question (44a), *with whom was Peter talking*, that it should demand something of category PP to combine with, but in fact this question can be answered with a DP fragment *Mary* unproblematically (*pace* Ginzburg and Sag’s judgments). Again, the contrast between English (and other P-stranding languages) and Greek (and other pied-piping languages) remains unexplained.

However, this contrast is accounted for by a movement-plus-ellipsis account: the English DP-only answer is simply the below.

- (51) With whom was Peter talking? — Mary ~~Peter was talking with~~  $\bar{t}$ .

### 2.4.1.2 Subjectless vP fragments

Another issue for accounts which do not contain clausal structure is that v/VPs can be fragments, as shown below.

(52) What should I do? — Go to the doctor.

So too can categories somewhat bigger than VP, for example categories big enough to contain aspect morphology, as in the below examples from Stainton 2006b:

- (53) a. [Looking at a fast-moving car.] Moving pretty fast!  
b. [Dealer indicating a car.] Driven exactly 10,000 miles.

On analyses in which these subsententials are ‘bare’, then the fragments in (53) are only as big as something like AspP, or whatever category(ies) smaller than TP we want to analyze progressive or perfective verbal constituents as.

The problem on this account is the location of the subject. Under the VP-internal subject hypothesis (Koopman & Sportiche 1991 a.m.o.), the subject should be base-generated in a low position (the Spec of vP or VoiceP, following e.g. Kratzer 1996) and should then raise to [Spec, T], the canonical subject position in English.

However, on a ‘bare constituent’ analysis of a ‘small’ verbal subsentential such as (52), (53), there is no [Spec, T] position for the subject to move into. It should therefore be stranded in a low position, and we might expect that it should get pronounced in such a verbal fragment, contrary to fact. In a very ‘small’ constituent such as (52), we might assume that this is only as big as VP, and following Kratzer 1996, the subject (merged in a higher Spec, vP or VoiceP) has not yet been merged in. However, on standard assumptions, aspectual morphology is merged in a higher position than the initial Merge position of the subject, meaning that the subject should already have been Merged in in a fragment like (53). On the ‘bare constituent’ analysis, the subject should be pronounced in a low position. Explaining the fact that it is not pronounced would require the postulation of a silent subject

pronoun, perhaps PRO. However, note also that floated quantifiers are licit in such verbal fragments, as shown in (54).

- (54) a. What should the students do? — *All* turn up in the Chancellor’s office and protest.  
 b. *All* looking pretty good.  
 c. *All* driven no more than 10,000 miles.

On the ‘stranding’ analysis of floating quantifiers (Sportiche 1988 a.o.), such a position of *all* is the remnant of movement of a DP out of a QP which is left stranded in a low subject position, as below.

- (55) a. The students should all protest.  
 b. [TP [DP The students]<sub>1</sub> [TP should [vP [QP all t<sub>1</sub>] [vP protest]]]]

If this analysis of floating quantifiers is correct, then the presence of floating quantifiers in verbal fragments like (55) is diagnostic of subject movement out of those fragments. However, this only makes sense if there is higher clausal structure, such as TP, for subjects to move into. If the verbal constituent is generated ‘bare’, then the entire subject should appear within the VP. The lack of subject is immediately explained if verbal fragments are examples of full clausal ellipsis. On such an analysis, the subject has been merged and has risen to [Spec, T]; the verbal constituent which the subject has evacuated then moves to a left-peripheral position, and the rest of the clause elides:

- (56) a. [Go to the doctor] ~~you should t~~  
 b. [Driven exactly 10,000 miles] ~~this car has t~~  
 c. [All t<sub>1</sub> turn up in the Chancellor’s office and protest]<sub>2</sub> ~~[the students]<sub>1</sub> should t<sub>2</sub>~~

This analysis also explains why only verbal constituents which can moved are ones that can appear as fragments:

- (57) He said he should have been promoted. . .
- a. and promoted, he certainly should have been.
  - b. ?and been promoted, he certainly should have.
  - c. \*and have been promoted, he certainly should.
- (58) He said he should be promoted. . .
- a. ?and be promoted, he certainly should.
- (59)
- a. Should he have been promoted? — No, demoted.
  - b. Should he have left? — No, ?been promoted.<sup>17</sup>
  - c. Should he leave? — No, ?\*have been promoted.
  - d. Should he leave? — No, ?be promoted.

This distribution is predicted on the movement account, but not on the ‘bare constituent’ account.

The problems discussed above are problems for any account of fragments which does not assume that the fragment moves or that there is clausal structure. I now turn to some problems which are specific to the proposal in Jacobson 2013.

## 2.4.2 Problems for Jacobson 2013

### 2.4.2.1 Antecedents which are not questions

Not only questions license fragments. Antecedents containing indefinites and focused constituents also do.

---

<sup>17</sup>A certain amount of care is required here in picking the antecedent question, to make sure that the auxiliary *been* is in focus, and contrasts with the antecedent; this seems to be required to make the auxiliary’s appearance licit in a fragment. It is marked, for example, to pronounce the auxiliary in the below example; but as (59b) shows, it is not ungrammatical as such.

- (i) Should he have been promoted? — ??No, been demoted.

- (60) a. Someone left early — John.  
 b. MARY left early. — No, John.

This is problematic for Jacobson’s analysis, in which the fragment directly combines with a preceding syntactic interrogative; there are no interrogatives in (60), and therefore nothing for the fragment to combine with. The semantics also presents a problem. Questions may plausibly be interpreted as lambda-abstracts (e.g.  $\llbracket \text{Who left} \rrbracket = \lambda x.x \text{ left}$ ), but sentences like *Someone left early* or *MARY left early* are surely propositions ( $\llbracket \exists x.x \text{ left early} \rrbracket$ , and  $\llbracket \text{Mary left early} \rrbracket$  with the presuppositions attendant on focus marking (Rooth 1992b, Schwarzschild 1999, a.o.), respectively), not lambda-abstracts. It is therefore not clear how the subsentential like *John* in (60) could either syntactically or semantically combine with the given antecedents using a mechanism like Jacobson’s.

Jacobson 2013 claims that examples containing indefinites like (60a) are ungrammatical (assigning such examples a ?\* diacritic), but to my ear it is perfect, and I have not been able to replicate Jacobson’s judgment with other native speakers of English.<sup>18</sup> I believe the data are particularly clear when the *someone*-sentence and the subsentential are produced by different speakers, with intervening material such as *yeah*.

- (61) I hear someone left early. — Yeah, John.

Exchanges like (61) strike me as being impeccable.<sup>19</sup> Jacobson does acknowledge the goodness of the data like the below with *namely* or *i.e.*.

---

<sup>18</sup>Jacobson does not explicitly discuss focus cases (although she mentions the data in passing), but Ginzburg & Sag 2000 report fragments licensed by focus creating an implicit question (p. 301, fn. 10):

- (i) A: Does Bo know BRENDAN?  
 B: No, ~~she knows~~ Frank.

Such implicit questions are also extensively used by Merchant 2004:687ff. in order to investigate the properties of fragments extracted (on Merchant’s analysis) from islands, which will be discussed in more detail in section 4.5.

<sup>19</sup>Note again that material (*Yeah*) intervenes between the antecedent and the fragment, providing another example of the problem Jacobson acknowledges with the claim that fragments syntactically compose with their licensing antecedents.

- (62) a. Someone left the party early, namely Claribel.  
 b. Someone left the party early, i.e. Claribel.

Jacobson proposes that these are not true examples of subsententials, but rather something more like extraposition from a DP/NP-internal position; *namely/i.e.* phrases are proposed to be parts of complex generalized quantifiers – that is, *someone namely Claribel* is a complex GQ in the same way as something like *every boy but John*.

- (63) a. Someone – namely Claribel – left the party early.  
 b. Someone – i.e. Claribel – left the party early.

But an extraposition account seems to me to be implausible. Firstly, the examples in (63) seem fairly clearly to be parentheticals, requiring heavy prosodic breaks between the *namely/i.e.* phrases and the surrounding material. They do not seem to be parts of the generalized quantifier in the way that, for example, the *but*-phrase in *every boy but John* is. Secondly, given that subsententials can be replies by an interlocutor (as in (61)), an extraposition account would imply that an extraposed part of a complex generalized quantifier can be supplied by a second speaker. While extraposition of, for example, a *but*-part of a complex generalized quantifier is possible in general, as (64a) shows, this is quite marked across speakers, as shown in (64b), particularly so if material like *yes* intervenes (64c). However, a second speaker can easily provide a *namely*-phrase, as (65) shows, even with *yes* intervening (in fact to my ear (65) is better with the *yes* than without):

- (64) a. [Every boy t] left [but John].  
 b. Every boy left. — ??But John.<sup>20</sup>  
 c. Every boy left. — ?\*Yes, but John.

---

<sup>20</sup>This is less bad than (64c). It is possible that the second speaker in (64b) is ‘finishing’ the other speaker’s sentence for him. I think this is a possibility, but is in some sense metalinguistic. I do not think this generalizes to all cases of fragments or question–fragment answer pairs, however, for the reasons stated in this section.



(65) Someone left. — Yes, namely Claribel.

Thirdly, it is not clear how an extraposition account of this sort can deal with the focus cases, where the DP in the antecedent is a proper name which could not be extraposed from; and the fragment is also not plausibly something that would occur in construction with the DP in the antecedent.

(66) JOHN left early. — No, Mary.

In this case, it is very difficult to see how the subsentential reply can be accommodated on a view in which subsententials are syntactically and semantically integrated with their antecedent directly. It can be accommodated easily, however, if the reply in (66) is taken to covertly contain a *second* instance of a clause, deleted under (some form of) identity with an antecedent:

(67) JOHN left early. — No, Mary ~~left early~~.

— in short, an elliptical approach.

#### 2.4.2.2 Answering embedded questions

Jacobson notes that examples like the following are well-formed (all of (68) is spoken by the same speaker).

(68) I know who left early: Claribel.

Jacobson takes this to imply that certain verbs can embed not just questions, but Qu-Ans pairs. While Jacobson does not provide the exact syntactic constituency she is assuming, I assume that the structure of the above is something like (69), where the verb *know* is selecting for something of category Qu-Ans. (I mix Minimalist/GB-style representations of phrase markers here with categorial-style slash notation for ‘Qu-Ans/DP’, a label indicating a constituent that will provide a Qu-Ans once it has combined with a DP – that is, ‘Qu-Ans/DP’ is a constituent question in which the questioned constituent is of category DP.)

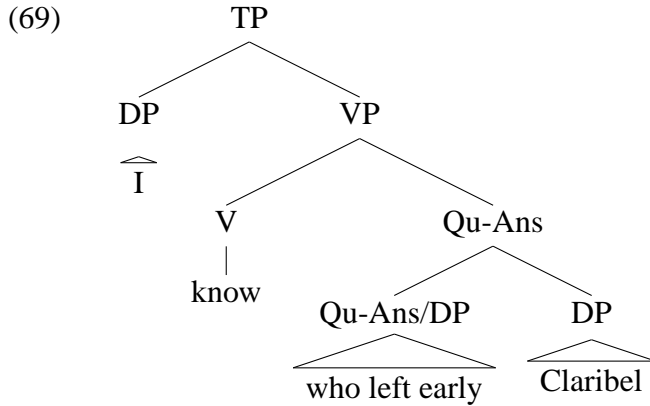

The semantics of the Qu-Ans part of such a tree would be as below.<sup>21</sup>

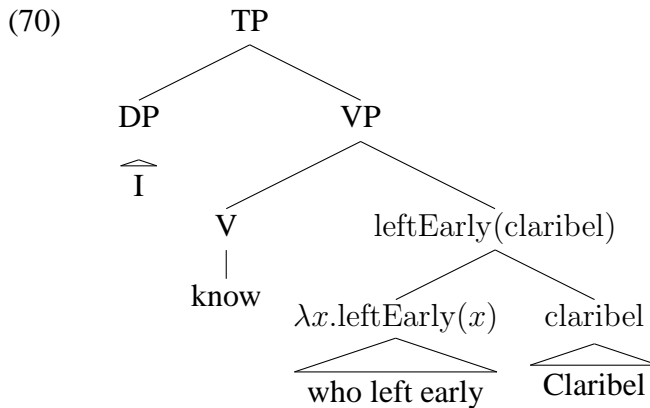

The interpretation that this would receive is that the speaker knows that Claribel left. This has rather weaker truth conditions than the sentence in (68) actually has, however. This sentence is only felicitously uttered in a situation where the speaker knows that Claribel left and that Claribel was the *only* person that left; that is, the answer here has to be exhaustive (Groenendijk & Stokhof 1984, Heim 1994 a.m.o.). Jacobson’s treatment of embedded Qu-Ans phrases does not account for this.

Even if concerns about exhaustivity could be handled, for example by pragmatic strengthening, examples like the below would still be problematic.

---

<sup>21</sup>The question meaning and the meaning of the whole Qu-Ans should be intensionalized, that is, the denotation of the Qu-Ans should be a proposition rather than a truth value. I abstract away from this, as Jacobson also does.

- (71) A: I wonder who left early.  
 B: Claribel.

B can, by using a subsentential constituent, provide an answer to the embedded question that A utters. The structure of such an utterance would, on Jacobson's analysis, presumably have to look something like the below (again with an ad hoc mix of Minimalist-style representations and categorial-style notation):

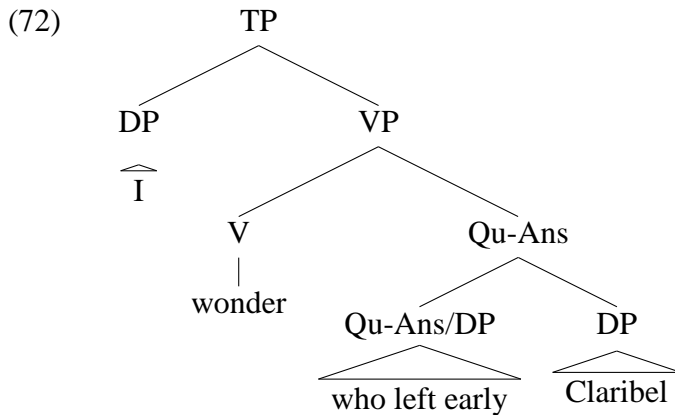

Here we have a syntactic problem. While syntactically combining entire utterances cross-speaker may be plausible, it is unclear how (72) is supposed to work when the DP *Claribel* is provided by a different speaker from the one that provides *I wonder who left early*. The problem is structure-building: it is not clear how the second speaker can provide a syntactic constituent *Claribel* which is meant to 'slot in' at a lower level than the root node. In Minimalist terms, this would be a case of countercyclic Merge, which is usually considered to be restricted in application, if countenanced at all. In categorial grammar terms, the constituency in (72) would imply that *Claribel* had right-concatenated with the string *who left early* before the resulting string right-concatenated with *wonder*; but then it is unclear how speaker A could pronounce the string *I wonder who left early* without pronouncing *Claribel*.

There is also a semantic problem in (72). Consider the denotations of the subtrees:

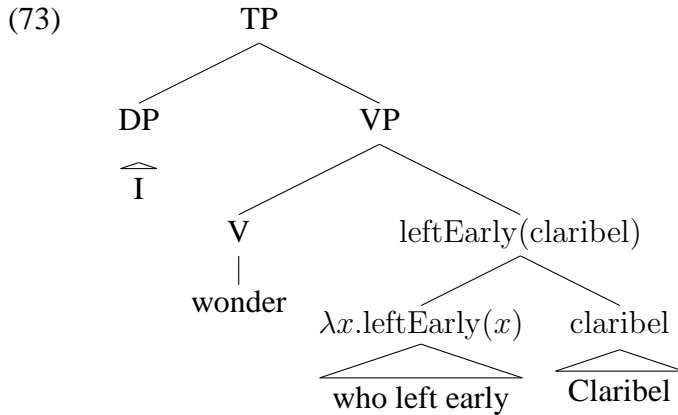

Here *wonder* would be selecting a proposition, the proposition ‘that Claribel left’. But *wonder* semantically selects for a question, not a proposition (Grimshaw 1979 a.m.o.):

- (74) a. I wonder whether Claribel left/who left/where Claribel went.  
 b. \*I wonder that Claribel left.

We might be able to solve the syntactic problem by allowing a dependency on an answer to copy up the tree and be resolved at the highest level (again, represented here with an ad hoc mix of Minimalist-style labels and categorial-style slashes):

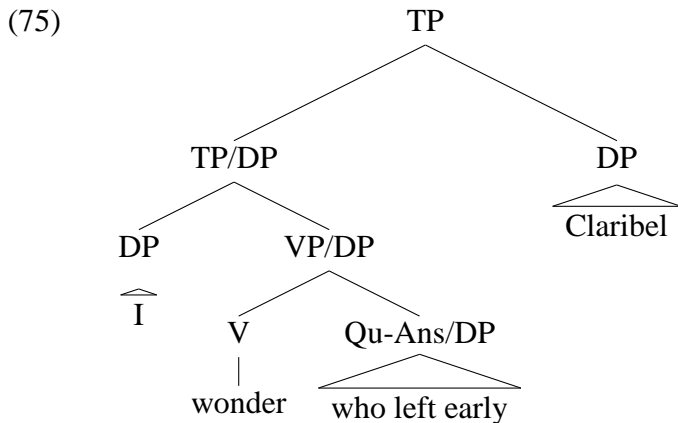

But it is not clear that this will solve the semantic problem. *I wonder who left early* does not itself denote a question or a lambda-abstraction of any kind, rather denoting a proposition.

It is therefore not clear how it could semantically compose with the denotation of the DP *Claribel*.

By contrast, on an elliptical account, fragments providing answers to embedded questions pose no problem. These examples are simply analyzed as the below.

- (76) a. I know who left early: Claribel ~~left early~~.  
 b. A: I wonder who left early.  
 B: Claribel ~~left early~~.

### 2.4.3 Problems for Stainton

In this section, I discuss some problems which are specific to Stainton's approach, in which the fragment does not interface with clausal syntax at all.

#### 2.4.3.1 The lack of immobile fragments

On Stainton's analysis, in principle, it appears that any syntactic category can be generated as a subsentential. If it has semantically unsaturated arguments, as in the case of a generalized quantifier for example, the manifest property combines with the denotation of the subsentential to deliver a proposition, as below.

- (77) a. [indicating a pair of empty chairs]  
 Two external examiners.  
 b.  $\llbracket \text{Two external examiners} \rrbracket = \lambda P. \exists x. |x| \geq 2 \ \& \ P(x) \ \& \ x \text{ are external examiners}$   
 c. Manifest property:  $\lambda x. \text{ these chairs are for } x$   
 d. Combination of the two:  $\exists x. |x| = 2 \ \& \ \text{these chairs are for } x \ \& \ x \text{ are external examiners}$

In principle, it seems as if this should be recursively possible. That is, if there is a subsentential which has *two* unsaturated property-type arguments, and there are also two salient

properties, one might imagine that both salient properties could combine with the denotation of the subsentential in turn, giving a propositional interpretation. On the face of it, this does indeed seem possible, as examples like the below show.

(78) [Context: I walk into a classroom containing fifty students. I'm used to one or two students being asleep at the start of a class, but this being the morning after an important game which the home team won, I am faced with thirty-seven sleeping students. I exclaim:]

Thirty-seven!

(79) [Same context.]

More than half!

(80) a. Two manifest properties:  $[\lambda x.x \text{ is sleeping}]$  and  $[\lambda x.x \text{ are students}]$

b.  $[[\text{thirty-seven}]] = \lambda P.\lambda Q.\exists x.P(x) \ \& \ Q(x) \ \& \ |x| \geq 37$

c. Combination of subsentential with the property 'being a student':

$\lambda Q.\exists x.x \text{ is a student} \ \& \ Q(x) \ \& \ |x| \geq 37$

d. Combination of the function thereby generated with the property 'sleeping':

$\exists x.x \text{ are students} \ \& \ x \text{ is sleeping} \ \& \ |x| \geq 37$

(81) a.  $[[\text{more than half}]] = \lambda P.\lambda Q.|P \cap Q| > \frac{1}{2}|P|$

b. Combination of subsentential with the property 'being a student':

$\lambda Q.|student \cap Q| > \frac{1}{2}|student|$

c. Combination of the function thereby generated with the property 'sleeping':

$|student \cap sleeping| > \frac{1}{2}|student|$

The problem comes when we consider the example below.

(82) [Context: same as before, but this time *all* the students are sleeping.]

\*Every!

It isn't clear what the semantic problem is with (82); we should imagine that two salient properties exist to saturate both arguments of *every*:

- (83) a.  $\llbracket \text{every} \rrbracket = \lambda P. \lambda Q. \forall x. P(x) \rightarrow Q(x)$   
 b. combining with the property 'student' and 'sleeping' in that order:  
 $\forall x. x \text{ is a student} \rightarrow x \text{ is sleeping}$

The problem rather seems to be a syntactic one. The obvious difference between *every* and something like *thirty-seven* or *more than half* is that the latter license noun phrase ellipsis, while *every* does not:

- (84) a. John ate two cookies, but I ate thirty-seven (cookies).  
 b. John ate less than half the cookies, and I ate more than half (the cookies).  
 c. John ate no cookies; I ate every \*(cookie).

So the obvious treatment of subsententials like *thirty-seven* or *more than half* is that these are actually *thirty-seven students* and *more than half the students*, respectively, with NP ellipsis.

This is easily accounted for on the movement-plus-ellipsis account of subsententials: the fragment *thirty-seven students* moves, clausal ellipsis takes place, and the NP *students* elides independently of the clausal ellipsis:

- (85)  $\llbracket \text{Thirty-seven} \langle \text{students} \rangle \rrbracket \text{ } \text{t-are-sleeping}$   
 where  $\langle \text{angle brackets} \rangle$  indicate noun phrase ellipsis and ~~strikethrough~~ indicates clausal ellipsis

*Every* cannot license noun phrase ellipsis in this way, and so subsentential *every* is not licensed.

This does not, however, clearly follow from Stainton's analysis. It is not clear what would rule out the generation of the bare determiner *every*, with its semantic arguments being saturated by manifest properties. The system might be augmented with a grammatical

requirement that subsententials must be phrasal (not heads like the determiner *every*), but this would be an extra stipulation on this account; however, this requirement follows immediately from a movement-plus-ellipsis approach, as A'-movement of the type implicated on a movement-plus-ellipsis account can only target phrases, and would be predicted not to move a category like *every* on its own.

#### 2.4.3.2 The problem of too many salient properties

Stainton's approach proposes that a subsentential is understood as giving a propositional meaning by composing with a salient or manifest property. This raises the issue of which properties count as 'salient'.<sup>22</sup> In this respect, consider examples like (86).

- (86) Q: Who did John say has the key to the liquor cabinet?
- a. Mary.
  - b. Well, Mary has the key to the liquor cabinet, but I don't know what John said.
  - c. #Well, Mary, but I don't know what John said.

Here, the subsentential *Mary* is grammatical in principle, as shown in (86a). However, it cannot be understood as meaning that Mary is actually the one with the key (an 'embedded' reading, retrieving the denotation of the embedded clause *has the key to the liquor cabinet* in the antecedent), while not addressing the question of what John thinks, as shown by the infelicitous continuation *but I don't know what John said* in (86c). Such a contribution to the conversation is not uncooperative or impossible in principle, as (86b) shows; you just can't use the subsentential *Mary* to do it.

The problem here is that the property  $[\lambda x.x \text{ has the key to the liquor cabinet}]$  should be just as salient as  $[\lambda x. \text{ John thinks that } x \text{ has the key to the liquor cabinet}]$ . It is not clear why, on Stainton's analysis, an answer such as (85c) is not possible; the subsentential *Mary* should be able to combine semantically with the manifest property  $[\lambda x.x \text{ has the key to the}$

---

<sup>22</sup>See also Merchant 2010:sec. 2 for discussion of this issue.



liquor cabinet], to deliver the proposition that Mary has the key to the liquor cabinet. This should in principle be possible, especially given the context provided by the continuation *but I don't know what John thinks*. Intriguingly, the subsentential with this 'embedded' reading *is* licensed in the following, minimally different example.

- (87) John said that someone here has the key to the liquor cabinet.  
— (Well, yeah,) Mary. (I mean, I don't know what John thinks, but Mary has the key.)

It appears that the condition on the licensing of subsententials, and how we construe propositional meaning from them, must be sensitive to the difference between a sentence containing an indefinite such as (87) and one containing a *wh*-word such as (86). It is not immediately clear how this can be derived from Stainton's analysis, where the subsentential combines with a salient property. A similar point is made by the below example, due to Jeremy Hartman (p.c.).

- (88) Why did John go to the party?  
a. Mary went to the party, and John does everything Mary does.  
b. \*Mary, and John does everything Mary does.

Again, it seems plausible that the property  $[\lambda x.x$  went to the party] should be made salient by the linguistic context, and yet it cannot serve as the manifest property which would combine with the subsentential to give a propositional meaning on Stainton's account; that is, the subsentential *Mary* here cannot be understood as communicating the meaning *Mary went to the party*.

These examples, of course, are problematic for elliptical accounts of fragments also. Other elliptical processes, such as verb phrase ellipsis (VPE), can unproblematically pick up antecedents in embedded clauses. All of the cases discussed above which do not support subsententials do support VPE, for example.

(89) Who did John say has the key to the liquor cabinet?

— Well, Mary does ~~have the key to the liquor cabinet~~, but I don't know what John thinks.

(90) Why did John go to the party?

— Well, Mary did ~~go to the party~~, and John does everything Mary does.

It is unclear why, on the elliptical analysis of subsententials, the elided clause cannot pick up an antecedent in an embedded clause (while VPE can unproblematically do this). I will discuss this in much greater detail in chapter 3. However, on the face of it, such data look like they provide support for Jacobson's approach to fragments, in which subsententials directly compose with questions construed as categorial lambda-abstractions. We would expect in this case that, given the antecedent *Who did John say has the key to the liquor cabinet*, the subsentential *Mary* would only be able to combine with the entire antecedent clause, which would denote the abstraction  $[\lambda x. \text{John said that } x \text{ has the key to the liquor cabinet}]$ . It would not be able to combine with an abstraction  $[\lambda x. x \text{ has the key to the liquor cabinet}]$ , as no such abstraction exists in the antecedent for the fragment to syntactically and semantically combine with.

However, the same issue arises for Jacobson's account as arises for Stainton's; examples like the below (repeated from (87)), containing an indefinite rather than a *wh*-word, *do* license 'embedded' readings for subsententials.

(91) John said that someone here has the key to the liquor cabinet.

— (Well, yeah,) Mary. (I mean, I don't know what John thinks, but Mary has the key.)

It is not clear how Jacobson's approach can extend to this case in general, as discussed in section 2.4.2.1. However, it is also not clear what allows the fragment to compose with an 'embedded' meaning (here *x has the key to the liquor cabinet*) in the case where the antecedent contains an indefinite, rather than a *wh*-word. Of course, it is not clear on an

elliptical account either why the presence of an indefinite in the antecedent should make a difference compared to the presence of a *wh*-word; this will be discussed in chapter 3.

#### 2.4.4 Antecedentless fragments

We have seen from the discussion of Stainton's work that fragments can be antecedentless. While this is posed as a problem for the ellipsis account, it is also a problem for accounts such as Ginzburg & Sag 2000 and Jacobson 2013. In fact, I submit that it is more of a problem for these accounts than for the elliptical account. In direct-generation accounts, the fragments are syntactically dependent on an antecedent, in order to capture Case and binding facts. But this syntactic dependence between the fragment and the antecedent means that the antecedent must be a *syntactic* object. On Jacobson's approach, for example, a subsentential answer literally syntactically combines with the question it is answering. If there is no Qu, then there can be no Qu/Ans pair.

This might not be a problem if we made the syntactic dependence optional, but then of course we lose the empirical coverage of the fact that Case-matching seems to be obligatory rather than optional. Perhaps syntactic dependence of a fragment is not required just in case there is no antecedent to combine with. This would amount to saying that a subsentential need not find a SAL-UTT to match with (on Ginzburg & Sag 2000's analysis) or an interrogative to combine with (on Jacobson 2013's analysis), but rather could be generated on its own – perhaps with help from an analysis like Stainton's to provide the requisite propositional meaning. In fact, this analysis of antecedentless fragments would be more-or-less equivalent to Stainton's.

The problem with such a solution – and also, ipso facto, a problem for Stainton's approach – is that Case connectivity continues to be observed *even in 'antecedentless' cases*. Merchant points out that in certain discourse-initial situations, fragments are generated with the case that would be required if a verb were present. The 'café' examples are from

Merchant 2004:(219, 220); the ‘Both hands’ example is from Merchant 2010:fn. 11, after discussion in Stainton 2006b.<sup>23</sup>

- (92) a. (Enan) kafe (parakalo)!  
a coffee.ACC please  
‘(A) coffee (please)!’ (in a Greek café)
- b. Vody (pozhalujsta)!  
water.GEN please  
‘Water (please!)’ (in a Russian café)
- c. Dvumja rukami!  
two.INSTR hands.INSTR  
‘Both hands!’ (warning a Russian child to be careful with their bowl of soup)
- (93) a. Ferte mou (enan) kafe (parakalo)!  
bring.IMP me a coffee.ACC please  
‘Bring me (a) coffee (please)!’
- b. Dajte mne vody (pozhalujsta)!  
give.IMP me water.GEN please  
‘Give me (some) water (please)!’
- c. Pol’zujstva dvumja rukami!  
use two.INSTR hands.INSTR  
‘Use both hands!’
- (94) a. \*Kafes (parakalo)!  
coffee.NOM please
- b. \*Voda (pozhalujsta)!  
water.NOM please

---

<sup>23</sup>Thanks to Yelena Fainleib for confirmation that (94c) is ungrammatical. Sakshi Bhatia and Jyoti Iyer have commented to me (p.c.) that the same fact holds for Hindi in this case – an antecedentless fragment ‘both hands’ would have to be in instrumental case and would be ungrammatical in any other case.

- c. \*Dve ruki!  
two.NOM/ACC hands.GEN

Stainton 2006b:108f. suggests that these cases can be understood by assigning Case some semantic import. For example, the reason why *dvumja rukami* ‘both hands’ would obligatorily show up in the instrumental case in a Russian fragment is because the instrumental case itself might bear an instrumental semantics which would be obligatory on anything denoting an instrument, whether a subsentential or an argument within a sentential utterance. Merchant 2010 acknowledges this possibility for cases like instrumental, and it might also extend to cases like the genitive examples in Russian (*voda* ‘water.GEN’) which might plausibly be assigned a partitive semantics; however, it is less clear how such an account might extend to the obligatory use of a Case like accusative, which has been generally argued not to have any semantic import, as Merchant 2004 notes (sec. 5).

Case connectivity provides another argument against Stainton’s approach, in which a subsentential can be directly generated, with the propositional interpretation being inferred by the provision of a manifest property. Given this, and on the assumption that at least accusative and dative Cases do not have semantic import of their own, the below Case connectivity effects, repeated from (16), are mysterious.

(95) *German* (Merchant’s (49, 50))

- a. Wem folgt Hans? — Dem Lehrer. / \*Den Lehrer.  
who.DAT follows Hans — the.DAT teacher / the.ACC teacher  
‘Who is Hans following? — The teacher.’
- b. Wen sucht Hans? — \*Dem Lehrer. / Den Lehrer.  
who.ACC seeks Hans — the.DAT teacher / the.ACC teacher  
‘Who is Hans looking for? — The teacher.’

The point here is that *den Lehrer* and *dem Lehrer*, accusative and dative case versions of ‘the teacher’ respectively, should both denote the same entity (in a semantic metalanguage,  $\iota x.teacher(x)$ ). As Stainton’s theory works only on the level of the semantics, and

combines the meaning of a subsentential with a salient property, the Case of the fragment should not matter (we might even expect the least marked Case, presumably nominative, to be possible).

Stainton 2006b replies to this criticism by acknowledging that replies to explicit questions may indeed be elliptical, produced by a mechanism similar to that proposed by Merchant, and so case-matching is predicted to be required in cases like (95). The ‘manifest property’ mechanism would only be used to account for antecedentless fragments, not replies to explicit questions as in (95). However, the question then arises of why Stainton’s mechanism is not available *as well as* the elliptical mechanism in the case where there is an explicit question. There should in principle be two paths to generating a subsentential like *the teacher* in (95); one is the elliptical route, but the other is a directly generated subsentential without clausal structure which combines with a salient property (assuming that the property  $[\lambda x. \text{Hans is following } x]$  is made salient by the question<sup>24</sup>). If the latter option were available, it is unclear why the case connectivity is required. We would need a stipulation that, in answers to questions, *only* the elliptical route is possible.

This cannot be claimed as a complete victory for the ellipsis analysis, however. A similar problem is faced by ellipsis accounts. In order to claim that ‘out-of-the-blue’ fragments are elliptically generated – a claim we wish to preserve, due to the Case connectivity effects in antecedentless fragments discussed above – we seem to need to claim that no syntactic antecedent is required for an ellipsis site to be licensed.

- (96) a. The train station, please.  
        $\approx$  ~~Take me to~~ the train station, please.
- b. ~~Pol’zuj~~ ~~si~~ dvumja rukami!  
           use two.INSTR hands.INSTR  
           ‘Use both hands!’

---

<sup>24</sup>Although, as just discussed in section 2.4.3.2, there is the problem that it’s not clear which properties are ‘salient’ in the right way and which are not.

We might imagine that this implies that the antecedence condition on ellipsis is purely semantic (as suggested e.g. by Merchant 2001); however that semantic condition is properly defined, it may have enough ‘squish’ to allow for implicit antecedents to be construed within an ellipsis site even without explicit antecedents being present. Indeed, a theory of clausal ellipsis which allows for implicit antecedents to license ellipsis is one that will be defended later in this dissertation. However, if a syntactic antecedent is present, it appears to force a syntactic isomorphism between the antecedent and the content of the ellipsis site, as shown by the following data from Merchant 2010.

(97) Voice matching obligatory (Merchant 2010’s (23b), German)

- a. Q: Wer hat den Jungen untersucht? A: \*Von einer Psychologin.  
 who.NOM has the boy examined? by a psychologist  
 ‘Q: Who examined the boy? A: [intended] (He was examined) by a psychologist.’
- b. Q: Von wem wurde der Junge untersucht? A: \*Eine Psychologin.  
 by who.DAT was the boy examined a psychologist.NOM  
 ‘Q: Who was the boy examined by? A: [intended] A psychologist (examined him).’

Here, despite the fact that the two antecedents – active and passive versions of the same sentence – presumably bear the same truth conditions and make the same semantic denotations salient (or whatever will ultimately be required for a semantic antecedence condition on ellipsis), the presence of a clause with one voice specification does not seem to license the ellipsis of the version of the clause with the other voice specification:

(98) Q: Wer hat den Jungen untersucht?

A1: Eine Psychologin ~~hat den Jungen untersucht~~.

A2: \*Von einer Psychologin ~~wurde der Junge untersucht~~.

In this case, the defender of the ellipsis approach has to argue that syntactic isomorphism is obligatory just in case there is syntax to be isomorphic to. Otherwise, there is a greater freedom in what is construed within the ellipsis site. But whatever mechanism allows that greater freedom has to be constrained just in case there is an overt antecedent, just as Stainton's analysis has to rule out the 'bare' subsententials as answers to explicit questions.

So, on any approach, something needs to be said about the effect overt antecedents have on the acceptability of subsententials which do not syntactically match those antecedents. However, I think there is still an argument against the availability of a 'dual' approach (subsententials being generated either by clausal ellipsis or generated 'bare'), although a somewhat weakened one. A proponent of the clausal ellipsis (always) approach to fragments can state a constraint on the mechanisms used to license ellipsis: if an overt antecedent is available, then there is (some form of) syntactic or lexical matching requirement between the elided clause and the antecedent. If there is no antecedent, greater flexibility is allowed. This would be a constraint within one mechanism, the mechanism of ellipsis. Just such a mechanism will, in fact, be proposed in section 3.7 of this dissertation.

By contrast, a proponent of the 'dual' approach would have to say that, if it is possible to use clausal ellipsis to generate a subsentential in a given context, then a *different* grammatical mechanism – the generation of a 'bare' constituent which needs to combine with a Mentalese predicate to receive an interpretation – may not be used in that context. Such a restriction, for example, would be similar to one ruling out overt verb phrases if ellipsis could be used, or ruling out the use of a definite description if a pronoun could be used, as in the below cases.

- (99) a. John ate some fish, and Mary did too.  
b. ?John ate some fish, and Mary ate some fish too.
- (100) a. The man came in. He sat down.  
b. ?The man came in. The man sat down.



As can be seen, such effects do obtain (the type of case in (100) being discussed under the label of the Repeated Name Penalty, Gordon et al. 1993 a.o.), but they are subtle, and appear to be problems for the on-line processing mechanisms rather than representing a categorical, grammatical ban on the ‘disfavored’ mechanism. By contrast, a failure of Case connectivity in the subsentential cases is indeed categorically banned. For the ‘dual’ approach to be tenable, we would need to know what it is about the presence of a syntactic antecedent that forces the subsentential to be interpreted as if generated via clausal ellipsis (rather than generated ‘bare’). The proponent of the ellipsis approach has to answer a similar question about the effect of the antecedent on the syntactic content of the ellipsis site, but this can be understood as a constraint on the ellipsis mechanism, rather than as a restriction on the grammatical mechanisms available in principle in a given context.

## **2.5 Taking stock**

My conclusion is that the ellipsis-based account of subsententials is the correct one. The syntactic evidence, in particular the P-stranding generalization discussed by Merchant and the unavailability of fragments whose syntactic categories are immobile, points to this conclusion; and, I have argued, other extant analyses of subsententials which analyze them as being non-elliptical, such as Stainton’s, Ginzburg and Sag’s, and Jacobson’s, run into problems, many of which can be easily remedied on the assumption that subsententials are generated via a process of clausal ellipsis.

However, the considerations that motivate the non-elliptical analyses of subsententials remain to be addressed. My strategy to account for these considerations will be to concentrate on the semantic antecedence conditions involved in clausal ellipsis. My argument will be that a particular version of these antecedence conditions can suffice to account for the objections raised by authors who propose non-elliptical accounts. In addition, I will argue that this condition also accounts for the ability of indefinites to license fragments, as well as the distinction between antecedent clauses containing indefinites (which can license

‘embedded’ interpretations for fragments) and antecedent clauses containing long-moved *wh*-words (which cannot license ‘embedded’ interpretations). In the following chapter, I will discuss some existing proposals for the semantic antecedence condition on clausal ellipsis, and will provide arguments – some provided by authors who argue for non-elliptical analyses – that extant analyses are not sufficient. I will then propose a condition based on the notion of congruence with the Question under Discussion (Roberts 2012/1996), drawing particularly on a proposal by Reich 2007, which I argue can capture the data and allow us to retain an elliptical account of subsententials.

## CHAPTER 3

### FRAGMENTS AND THE SEMANTICS OF CLAUSAL ELLIPSIS

#### 3.1 Introduction

This chapter considers accounts of the semantic antecedence condition on clausal ellipsis. As stated in the previous chapter, I argue that modifying this condition will provide the key to understanding some of the problems raised by authors who argue that fragments are not created through ellipsis. I review previous accounts of the semantic constraint which an ellipsis site has to meet. I argue that none of them completely account for the data, but that a constraint which relates the semantics of the ellipsis site to the Question under Discussion (as proposed by Ginzburg & Sag 2000, Reich 2007, to a certain degree AnderBois 2010, and Collins et al. 2014) can deliver most of the explananda. I propose a version of such constraints which, I argue, can deliver all of the explananda. In particular, a QUD-based analysis accounts for variation in which linguistic antecedents clausal ellipsis can ‘pick up’, and also accounts for the fact that fragments can be uttered without any linguistic antecedent at all. I first review what fragments tell us about what a semantic antecedence constraint on clausal ellipsis should look like.

#### 3.2 Issues any elliptical analysis will have to handle

There are a number of problems which elliptical accounts of fragments have to account for. In this section, I enumerate three of these problems: (i) the failure of certain clauses to serve as antecedents for ellipsis in some cases; (ii) the range of elements in an antecedent which can serve as licensors for ellipsis; and (iii) the problem of presupposition inheritance.

### 3.2.1 Which clauses can be antecedents

We have seen that, given a constituent question in which a *wh*-word has moved from an embedded position to a matrix position, fragments can only ‘answer’ the matrix clause.

(101) (repeated from (86))

Q: Who did John say has the key to the liquor cabinet?

- a. Mary.
- b. Well, Mary has the key to the liquor cabinet, but I don’t know what John said.
- c. #Well, Mary, but I don’t know what John said.

That is, the elided clause can be the matrix clause of the antecedent, as in (102a), but not the embedded clause, as in (102b).

- (102) a. Mary [~~John said t has the key to the liquor cabinet~~]  
b. \*Mary [~~t has the key to the liquor cabinet~~]

However, we have also seen that embedded clauses containing indefinites *can* be the antecedents for clausal ellipsis.

(103) (repeated/adapted from (87))

John said that someone here has the key to the liquor cabinet.

- a. Yeah, Mary. John said Mary has the key. (But it’s actually Bill that has it.)
- b. Yeah, Mary. I mean, I don’t know what John said, but Mary has the key.

- (104) a. Mary [~~John said that t has the key to the liquor cabinet~~]  
b. Mary [~~t has the key to the liquor cabinet~~]

The same is true of embedded clauses containing focused material:

(105) John said that BILL has the key to the liquor cabinet.

- a. No, MARY. You reported that wrong: John said MARY has the key.

- b. No, MARY. I don't know what John said, but you should know that it's actually Mary that has the key.

- (106) a. Mary [~~John said that t has the key to the liquor cabinet~~]  
 b. Mary [~~t has the key to the liquor cabinet~~]

VP ellipsis does not seem to be sensitive to this distinction, as we can see from (107). VP ellipsis in (107) can pick up the embedded clause unproblematically and in (108), the VP ellipsis site can pick up either the matrix or embedded clauses.

- (107) Who did John say has the key to the liquor cabinet?  
 a. Well, Mary actually does ~~have the key to the liquor cabinet~~, but I don't know what John said.

- (108) John said that someone here has the key to the liquor cabinet.  
 a. Yes, Mary does ~~have the key to the liquor cabinet~~ (although I don't know what John said).  
 b. Yes, and Mary did ~~say that someone here has the key to the liquor cabinet~~ too.

- (109) John said that BILL has the key to the liquor cabinet.  
 a. That's wrong – Mary does ~~have the key to the liquor cabinet~~.

If we wish to analyze fragments as involving ellipsis, the conditions on that ellipsis will have to cleave the correct distinction between VP ellipsis and clausal ellipsis as shown above, and will also have to account for the fact that *wh*-questions enforce a matrix interpretation of the elided clause, while indefinites and focused elements allow embedded interpretations.

Furthermore, even matrix questions can sometimes fail to provide antecedents for clausal ellipsis, as the below example (repeated from (88), due to Jeremy Hartman p.c.) indicates.

- (110) Why did John go to the party?
- a. Mary went to the party, and John does everything Mary does.
  - b. \*Mary ~~went to the party~~, and John does everything Mary does.

Despite the fact that *John went to the party* is present in the linguistic context, it cannot be picked up as an antecedent for clausal ellipsis, as shown by the failure of (110b) to mean ‘Mary went to the party, and ...’. Note that, again, VP ellipsis can pick this antecedent up unproblematically:

- (111) Why did John go to the party?
- Mary did ~~go to the party~~, and John does everything Mary does.

The failure of clausal ellipsis to pick up such antecedents, which should in principle be available, is an issue which an elliptical account will need to handle.

### 3.2.2 What licenses clausal ellipsis

I now consider the question of what sort of antecedents license fragments. *Wh*-questions clearly license fragments.

- (112) A: Who left early? B: John.

So do focused elements:

- (113) A: MARY left early. B: No, John.

Indefinites and certain quantifiers also license fragments. These examples should be pronounced with all-new intonation, with ‘default’ stress placement (indicated here with a grave accent), in order to show that it is the indefinite/quantifier itself which is licensing the fragment, independently of the power of focus to do so.

- (114) a. A: Someone/a man with a hat drank all the b  er.  
B: Yeah, John.

- b. A: Two students drank all the beer.
- B: Yeah, John and Mary.

Some other quantifiers, however, are considerably more marginal.<sup>25</sup>

- (115)
- a. A: Most students came to class today.
  - B: ?#Yeah, John, Mary, Bill, Anne, Tom and Sue.
  - b. A: Few students came to class today.
  - B: ?#Yeah, John and Mary.

Again, this contrasts with VP ellipsis, which is licensed in (115):

- (116)
- a. A: Most students came to class today.
  - B: Yeah, John, Mary, Bill, Anne, Tom and Sue did ~~come to class today~~.
  - b. A: Few students came to class today.
  - B: Yeah, (but) John and Mary did ~~come to class today~~.

A theory of fragments that appeals to clausal ellipsis will have to explain why weak quantifiers license fragments but strong quantifiers do not, as well as the difference between clausal ellipsis and VP ellipsis in this respect.

Another interesting contrast between clausal ellipsis and VP ellipsis is discussed by AnderBois 2010 with respect to sluicing. AnderBois points out that indefinites license sluicing, but negative quantifiers under negation do not, even though these are semantically equivalent (that is,  $\neg\neg\exists x.P(x) \Leftrightarrow \exists x.P(x)$ ).

---

<sup>25</sup>The precise characterization of the ‘cut’ between quantifiers is not clear to me: the temptation is to say that only phrases which can have a ‘type-e’ meaning can license fragments (that is, *someone/a man/two students* can be seen as indefinites which refer to particular entities, alongside their quantificational readings (see e.g. Heim 1982)). However, Constant 2012b convincingly argues that quantifiers like *most students* (although not negative quantifiers like *few students*) do have type-e readings. I will not try to explore the distinction between (114) and (115) in detail here.

- (117) a. Someone left, but I don't know who.  
 b. #It's not the case that no-one left, but I don't know who.

This extends to fragment answers also.

- (118) a. A: Someone left. B: Yeah, John.  
 b. A: It's not the case that no-one left. B: #Yeah, John.

In addition, AnderBois argues that clauses that are within appositives cannot provide a sluice's antecedent:

- (119) a. John once killed a man in cold blood, but he can't even remember who.  
 b. #John, who once killed a man in cold blood, doesn't even remember who.

Again, this extends to fragment answers.

- (120) a. A: John once killed a man in cold blood, I hear.  
 B: Yeah, Bill.  
 b. A: John, who once killed a man in cold blood, is otherwise nice.  
 B: #Yeah, Bill.

AnderBois points out that VP ellipsis is good in these cases.

- (121) a. It's not the case that no-one left, but I don't know who did ~~leave~~.  
 b. John, who doesn't look after his sister, says that Mary should ~~look after~~  
~~his/her sister~~.

In addition, restrictive relative clauses, by contrast with appositives, can contain an indefinite which provides the antecedent for a fragment. Either indefinite in (122) can license fragments; the 'outer' indefinite, containing the relative clause, is shown licensing the fragment in (122a), while the 'inner' indefinite contained within the relative clause is shown licensing the fragment in (122b).



- (122) John saw a man who killed a woman in cold blood, I hear.
- a. Yeah, Bill ~~John saw t~~.
  - b. Yeah, Mary ~~John saw a man who killed t in cold blood~~.

Again, a theory of fragments (and indeed of sluicing) which analyses them as clausal ellipsis will have to account for the failure of double negatives and material within appositives to license it, as well as the contrast between putative clausal ellipsis and VP ellipsis.

### 3.2.3 The problem of presupposition inheritance

Jacobson 2013 points out a number of cases where short answers behave differently from their putative full clausal counterparts. I will refer to this property of short answers as *presupposition inheritance*: the short answers ‘inherit’ the presuppositions of the antecedent sentence, for example of an NP restrictor in a constituent question, in a way that need not be the case for a full clausal answer, or for an answer containing VP ellipsis.

For example, the clausal answer in (123a) communicates that John and Bill came to the party. It need not, however, communicate that John and Bill are in fact linguists, as the continuation shows. Rather, it can be construed as what Jacobson terms a ‘best-I-can-do’ answer. It communicates that John and Bill came to the party, but also implies that the speaker is unsure whether or not John and Bill are linguists. The verb phrase ellipsis answer in (123b) has the same property.<sup>26</sup> However, the short answer does not allow this; (123c) commits the speaker to the view that John and Bill are linguists.

---

<sup>26</sup>Jacobson reports that some speakers report the VPE answer in (123b) as degraded with respect to the full clausal answer (123a), but not as bad as the short answer (123c). I don’t personally share this intuition, but some other English speakers I have asked have also reported it. It may be worth noting that I have even found a very few speakers who accept (123c), although the majority agree that it is quite sharply infelicitous.

(123) (after Jacobson)

Which linguists came to the party?

- a. John and Bill came to the party... (but I don't know if they're linguists.)
- b. John and Bill did... (but I don't know if they're linguists.)
- c. #John and Bill... (but I don't know if they're linguists.)

Jacobson notes that cases where the response denies a presupposition of the question in this way are best with a particular intonation, which she dubs the 'best-I-can-do' intonation: I diagnose this intonation as a rise-fall-rise contour or B-accent over the whole clause, with the rise-fall on the focused element and the final rise at the end of the clause. The presence of this rise-fall-rise contour, however, does not improve the short answer: (123c) can be pronounced either with 'normal' (falling) intonation or with a rise-fall-rise contour, but is infelicitous in either case. A similar effect is seen in answers which are quantificational, as in (124).

(124) Which students were dancing in the quad?

- a. Some Germans were dancing in the quad... (but I don't know if they were students).
- b. Some Germans were... (but I don't know if they were students).
- c. #Some Germans... (but I don't know if they were students).

Again, the clausal answer in (124a) and VPE answer in (124b) communicate that I saw some Germans, but it is not necessary that they were students. The short answer in (124c), however, commits the speaker to the claim that the students that he saw were Germans.

The rise-fall-rise contour in the best-I-can-do answers is not responsible for the infelicity of the short answers: an example of a similar effect can be seen in (125) (due to Jeremy Hartman p.c.), in which providing the information that Jane Austen wrote *Emma* is not a 'best-I-can-do' answer, and in which *Jane Austen* (in the full clausal answer (125a) and the VPE answer (125b)) is pronounced with focus (falling) intonation.

- (125) Which Brontë sister wrote *Emma*?
- a. Jane Austen wrote Emma, you fool.
  - b. Jane Austen did, you fool.
  - c. #Jane Austen, you fool.

Here, the clausal answer in (125a) can correct a presupposition of the question (that one of the Brontë sisters wrote *Emma*). The VPE answer in (125b) can also do this. However, the short answer in (125c) cannot do this, and is so infelicitous in this context.

These differences between short answers and clausal answers form one of Jacobson 2013's main arguments that short answers should not be derived by ellipsis from full clauses, as their behavior does not seem to follow from the behavior of forms of ellipsis such as verb phrase ellipsis. As I have discussed above, I believe there are reasons to reject the conclusion that short answers do not involve ellipsis. However, the challenge which Jacobson raises has to be answered: it is clear that, at least, the clausal ellipsis mechanism which is appealed to will have to differ from the VP ellipsis mechanism, in which presuppositions do not need to be inherited.

On a view of fragments which makes reference to clausal ellipsis, these three problems – the problem of embedded antecedents, the ability of some elements in some configurations to license fragments but not other elements in other configurations, and the problem of presupposition inheritance – will have to be accounted for by part of the theory of ellipsis. At least the latter of these concerns seems to most easily be characterizable in semantic terms, rather than in ways which make reference to the syntax involved in ellipsis. This also seems to be a plausible way of characterizing the difference between indefinites and double-negatives, or appositives and restrictive relatives. My strategy therefore will be to pursue the hypothesis that these effects should fall out from the correct formulation of the semantic antecedence condition on clausal ellipsis. To that end, I will review existing proposals for the semantic antecedence condition; none of the existing proposals, I argue,

correctly capture all of the data above. I will then propose my own revision of the semantic antecedence condition which, I will argue, does succeed in capturing these data.

### 3.3 Previous approaches to the antecedence condition

In my treatment of previous proposals, I will split them into what I will call *focus-based* approaches and *question-based* approaches. This is not a clean cut; as we will see the ‘question-based’ approaches also make reference to focus semantics. However, I will adopt the labels for convenience here.

#### 3.3.1 Focus-based approaches

##### 3.3.1.1 Rooth 1992a: contrast condition

Rooth 1992a proposes a condition on VP ellipsis, which is summarized by Johnson 2001 as follows.

(126) (Johnson’s (52))

- a. An elided VP must be contained in a constituent which contrasts with a constituent that contains its antecedent VP.
- b.  $\alpha$  contrasts with  $\beta$  iff
  - (i) Neither  $\alpha$  nor  $\beta$  contain the other, and
  - (ii) For all assignments  $g$ , the semantic value of  $\beta$  w.r.t.  $g$  is an element of the focus value of  $\alpha$  w.r.t.  $g$ .
  - (iii) The focus value of  $[\xi \dots \gamma \dots]$ , where  $\gamma$  is focused, is  $\{\phi : [\phi \dots x \dots]\}$ , where  $x$  ranges over things of the same type as  $\gamma$  and the ordinary semantic value of  $\xi$  is identical to  $[\phi]$  except that  $x$  replaces  $\gamma$ .

An example of this constraint at work is given in (127).

(127) a. John read Aspects, and [<sub>F</sub> Mary] did ~~read Aspects~~ too.

- b. The VP [read Aspects] in the second conjunct is contained within the clause [[<sub>F</sub> Mary] read Aspects]. This clause has the focus value {Mary read Aspects, John read Aspects, Sue read Aspects, Bill read Aspects ... }
- c. There is a constituent – namely [John read Aspects] – which is a member of the focus value of [[<sub>F</sub> Mary] read Aspects]. This antecedent constituent contains the VP [read Aspects], and therefore the ellipsis of [read Aspects] in the second conjunct is licensed.

Can this constraint be extended to clausal ellipsis? Given the fact that VP ellipsis is licensed in a number of situations in which clausal ellipsis is not, this does not seem to be the way to go; and indeed a contrast condition between clauses does not, for example, capture the inability of clausal ellipsis to pick up embedded clauses as antecedent.

- (128)
- a. A: Who did John say has the key to the liquor cabinet?  
B: #Mary ~~† has the key to the liquor cabinet.~~
  - b. Putative antecedent clause is [x has the key to the liquor cabinet]. Whatever value the assignment function *g* gives to the variable *x* in this clause, it will be a member of the focus value of the elided clause (i.e. {Mary has the key to the liquor cabinet, Bill has the key to the liquor cabinet, ... })
  - c. As the antecedent and the elided material are both contained within constituents that satisfy the contrast relation, the ellipsis should be licensed, contrary to fact.

Such a condition also does not capture presupposition inheritance in short answers, as shown below.

- (129)
- a. A: Which student [t left early]? B: #John ~~† left early~~, but he isn't a student.
  - b. Putative antecedent clause is [x left early]. Whatever value the assignment function *g* gives to the variable *x* in this clause – even if we assume that the value it can take is restricted to students – it will be a member of the focus

value of the elided clause; the focus value of the elided clause will range over everything of the same type as *John*, i.e. {John left early, Mary left early, Bill left early, ... }

- c. As the antecedent and the elided material are both contained within constituents that satisfy the contrast relation, the ellipsis should be licensed, contrary to fact.

We can see, therefore, that an extension of Rooth 1992a's focus-based condition on VP ellipsis does not make the right predictions for clausal ellipsis.

### 3.3.1.2 Merchant: e-GIVENness

An influential proposal for the identity condition on clausal ellipsis is e-GIVENness, a constraint proposed in work by Jason Merchant (Merchant 2001, 2004), building on Schwarzschild 1999's definition of GIVENness and on Rooth 1992a's focus-based condition.

- (130) a. A clause may be elided if it is e-GIVEN.
- b. A clause E is e-GIVEN if there is an antecedent clause A such that  $F\text{-clo}(A) \Leftrightarrow F\text{-clo}(E)$ .
- c. The focus closure (F-clo) of a clause is the denotation of that clause with all focused elements replaced by variables, and all variables (that is, traces as well as focused elements which have been replaced) having been existentially closed.

An example of this condition at work is given below for a sluicing example and a fragment answer example.

- (131) a. John ate something, but I don't know what. [~~John ate t~~]  
 b. Antecedent:  $\llbracket \text{John ate something} \rrbracket = \exists x. \text{John ate } x$   
 c. F-closure of antecedent:  $= \exists x. \text{John ate } x$   
 (identical, as all variables are already bound)  
 d. Elided clause:  $\llbracket \text{John ate } t \rrbracket = \text{John ate } x$   
 e. F-closure of elided clause:  $\exists x. \text{John ate } x$   
 F-closures of antecedent and elided clause are in a mutual entailment relationship, so ellipsis is licensed.
- (132) a. John ate [<sub>F</sub> the beans]. — No, [<sub>F</sub> the chips].  
 b. Antecedent:  $\llbracket \text{John ate the beans} \rrbracket = \text{John ate the beans}$   
 c. F-closure of antecedent:  $= \exists x. \text{John ate } x$   
 d. Elided clause:  $\llbracket \text{John ate } t \rrbracket = \text{John ate } x$   
 e. F-closure of elided clause:  $\exists x. \text{John ate } x$   
 F-closures of antecedent and elided clause are in a mutual entailment relationship, so ellipsis is licensed.

As can be seen, this principle delivers results which are on the face of it correct for both sluicing and fragment answers, and in particular, it captures the fact that indefinites and focused elements license clausal ellipsis. Indefinites introduced an existentially closed variable, as shown in (131), which can correspond to a variable representing a trace in the elided clause which is then existentially closed via the mechanism of F-closure. Focused elements in the antecedent are also transformed into existentially closed variables by the mechanisms of F-closure.

e-GIVENness does not completely solve any of our 'three problems', however. Given the definition of e-GIVENness provided, a clause is e-GIVEN if there is any antecedent which mutually entails the elided clause, modulo F-closure. Clausal ellipsis should therefore be

able to pick up an embedded clause in a constituent question as its antecedent, contrary to fact:

- (133) a. A: Who did John say has the key to the liquor cabinet?  
B: #Mary ~~has the key to the liquor cabinet~~.
- b. Putative antecedent clause: [t has the key to the liquor cabinet]  
F-closure:  $\exists x.x$  has the key to the liquor cabinet
- c. Putative elided clause: [t has the key to the liquor cabinet]  
F-closure:  $\exists x.x$  has the key to the liquor cabinet  
F-closures are identical, so ellipsis should be licensed, contrary to fact.

We might rework e-GIVENness to look only for main, unembedded clauses as the antecedents of elided clauses; but we then lose coverage of the fact that fragment answers *can* pick up embedded clauses as antecedents if they contain indefinites. This fact is also true of sluicing, the construction which originally prompted Merchant to propose the e-GIVENness condition.

- (134) a. A: John said someone here has the key to the liquor cabinet.  
B: Yeah, Mary ~~has the key to the liquor cabinet~~.
- b. John said someone here has the key to the liquor cabinet, but I don't know who ~~has the key to the liquor cabinet~~.

Furthermore, there are cases in which even matrix clauses cannot supply the appropriate antecedent, as in the below example repeated from (88).

- (135) Why did John go to the party?
- a. Mary went to the party, and John does everything Mary does.
- b. \*Mary, and John does everything Mary does.

e-GIVENness does, by virtue of its f-closure mechanism, capture the fact that indefinites, focused material, and *wh*-words (which move and leave an existentially closed variable)



license fragments, while quantifiers like *few* do not. However, as AnderBois 2010 points out, it does not capture the fact that double-negation indefinites do not license fragments; because double negatives and simple indefinites are truth-conditionally equivalent, e-GIVENness could not distinguish between them. e-GIVENness does also does not capture the fact that antecedents cannot be found in appositives, for the same reasons as discussed for embedded clauses above; it is not clear how to restrict e-GIVENness from finding the clausal antecedent in the appositive.

Finally, the problem of presupposition inheritance is not captured by e-GIVENness. We can see that in the pair below, the F-closed antecedents and elided clauses *do* entail one another (as they are identical). However, ellipsis is not licensed in this example.

- (136) a. Which Brontë sister [t wrote Emma]?
- \*Jane Austen [~~t wrote Emma~~]
- b.  $\exists x.x$  wrote Emma  $\Leftrightarrow$   $\exists x.x$  wrote Emma

One might suggest that the NP restrictor is interpreted in the trace position as well as in the moved position in the antecedent, following for example Fox 2002's mechanism of Trace Conversion. If this were the case, the mutual entailment relation would not hold between the antecedent and elided clause.

- (137) a. Which Brontë sister [ [t Brontë sister] wrote Emma ]?
- F-closure of antecedent:  $\exists x.x$  is a Brontë sister &  $x$  wrote Emma
- b.  $\exists x.x$  is a Brontë sister &  $x$  wrote Emma  $\not\Leftrightarrow$   $\exists x.x$  wrote Emma

However, this cannot be a general solution, in the light of examples like the below.

- (138) Some students left. Some professors, too. (= some professors ~~left~~)

Here, if the NP restrictor is generally interpreted within the antecedent and elided clauses, the mutual entailment would not go through:

(139)  $\exists x.x$  are students and  $x$  left  $\not\Rightarrow \exists x.x$  are professors and  $x$  left.

e-GIVENNESS, as formulated in Merchant 2001 for example, does not capture this contrast.

### 3.3.2 Question-based approaches

An intuition that drives a number of approaches to clausal ellipsis is that there should be some form of semantic ‘congruence’ between the elided clause and an antecedent semantic question.<sup>27</sup> In this section, I will review a selection of these analyses.

#### 3.3.2.1 Krifka 2006: background matching

Krifka 2006 proposes a condition on short answers where a background – roughly, all constituents in an utterance except the focused one(s) – can be elided under a particular congruence relation between the ellipsis-containing clause and an antecedent question. Krifka uses a structured meaning account of questions, in which a constituent question can be represented as an ordered pair  $\langle W, B \rangle$ , where  $W$  is the set over which the questioned constituent ranges, and  $B$  (the ‘background’) is the denotation of the proposition from which the questioned constituent has been extracted, with the variable left by the questioned constituent lambda-abstracted over. An example is given below.

- (140) a. Which student did John meet?  
b.  $\langle \{x|x \text{ is a student}\}, \lambda x. \text{John met } x \rangle$

Krifka proposes that an utterance containing focus can also be semantically represented as a similar structured object, an ordered triple  $\langle F, A, B' \rangle$ , in which  $F$  is the denotation of the focused constituent,  $A$  is the set of focus alternatives to  $F$  (à la Rooth 1992b), and  $B'$  is again a lambda abstraction representing the background in the same fashion as above. An example is given below.

---

<sup>27</sup>As discussed in section 2.3.2.2, Jacobson 2013, while not incorporating ellipsis in its analysis, is also based on this general intuition; in her analysis, fragments/short answers directly compose syntactically and semantically with antecedent interrogatives/questions.

- (141) a. John met [<sub>F</sub> Bill ].  
 b.  $\langle \text{Bill}, \{\text{Bill}, \text{Mary}, \text{Sue}, \dots\}, \lambda x. \text{John met } x \rangle$

Krifka proposes that there is a congruence condition between questions and answers, to ensure the correct focus placement in an answer, shown below.<sup>28</sup>

- (142) (Krifka's (79))

A pair  $\text{QUEST}(\langle W, B \rangle) - \text{ANSW}(\langle F, A, B' \rangle)$  is congruent iff:

$B=B'$  and  $W \subseteq A$  (or  $W=A$ ).

If congruent, the answer asserts that out of the elements  $X$  of  $A$ , it hold for  $X=F$  that  $B(X)$ .

For example, the question-answer pair *Which student did John meet? — John met [<sub>F</sub> Bill]* is congruent because they have identical backgrounds ( $\lambda x. \text{John met } x$ ), and because the set of students is a subset of the focus value of *John* (which is the set of all entities). Krifka proposes that, in a congruent question-answer pair, all clausal material in the answer other than the focused material can be elided, resulting in question-short answer pairs like *Which student did John meet? — Bill*.<sup>29</sup>

This approach has the advantage that we predict that embedded clauses in interrogatives cannot provide the antecedent for a fragment answer: the backgrounds do not match.

- (143) a. Who did Mary say has the key to the liquor cabinet?

Background  $B = \lambda x. \text{Mary said } x \text{ has the key to the liquor cabinet}$

---

<sup>28</sup>It's not clear how general this constraint is meant to be. It can't be a general constraint on any sort of response to a question, as background-matching of the type required in (142) is clearly not required if the response is of the 'indirect' type:

- (i) A: Who ate the cake? B: Well, [<sub>F</sub> Bill]'s been looking kind of guilty lately.

Here, the background of the question ( $\lambda x.x$  ate the cake) and that of the answer ( $\lambda x.x$  has been looking kind of guilty lately) clearly do not match. I will understand the constraint in (142) as strictly applying only to short answers, and will discuss it in that light.

<sup>29</sup>Krifka embeds this in a syntactic theory of focus movement to the left periphery, making the syntactic side of this theory look very similar to that in Merchant 2004.

- b. \*<sub>[F Mary]</sub> ~~has the key to the liquor cabinet.~~

Background B =  $\lambda x.x$  has the key to the liquor cabinet

Backgrounds do not match; congruence condition not met, so ellipsis not licensed.

The same is true for cases such as the below. The background of the question *Why did John go to the party?* does not match the background of the elided clause, and so such cases are ruled out.

- (144) a. Why did John go to the party?

Background B =  $\lambda x.$  John went to the party for reason  $x$

- b. \*<sub>[F Mary]</sub> ~~went to the party~~ (and John does everything Mary does)

Background B =  $\lambda x.x$  went to the party

Backgrounds do not match; congruence condition not met, so ellipsis not licensed.

We could also imagine that this condition, with slight reworking, gives us the technology for dealing with focused phrases licensing ellipsis; if the condition is background-matching, we predict that clausal ellipsis should be good if the backgrounds of two clauses match, as below.

- (145) a. <sub>[F John]</sub> left early. (B =  $\lambda x.x$  left early)

- b. No, <sub>[F Mary]</sub> ~~left early.~~ (B =  $\lambda x.x$  left early)

However, it is not clear why indefinites license fragments on this account. Antecedents containing indefinites can have focus on constituents other than the indefinite, and yet the value of the elided clause is interpreted as if its background is a lambda-abstraction with a variable in the place of the indefinite in the antecedent, rather than one in the place of the focused constituent. The below example demonstrates this problem:

- (146) a. Somebody here has [<sub>F</sub> the key to the liquor cabinet].  
 Background B =  $\lambda x$ . somebody here has  $x$
- b. Yeah, Mary ~~has the key to the liquor cabinet~~.  
 Background B =  $\lambda x$ .  $x$  has the key to the liquor cabinet
- Backgrounds do not match so ellipsis should not be licensed, contrary to fact.

In addition, presupposition inheritance is not captured by this analysis. Consider the below example, in which ellipsis fails to go through.

- (147) a. Which student left early?  
 Semantic representation:  $\langle \{x | x \text{ is a student} \}, \lambda x.x \text{ left early} \rangle$
- b. \*Bill ~~left early~~ (but he's not a student).  
 Semantic representation:  $\langle \text{Bill}, \{\text{Bill}, \text{Mary}, \text{Sue}, \dots\}, \lambda x.x \text{ left early} \rangle$
- c. Congruence condition: backgrounds should match (met), and what the question ranges over should be a subset of the focus value of the answer (met, as the set of students is a subset of the set of focus alternatives to *Bill*, which is the set of entities). So ellipsis should be licensed even if Bill is not a student, contrary to fact.

Krifka suggests an alternative, stricter version of the condition matching focus alternatives to the question set, one in which they have to be equal. We might imagine that this solves our problem here: we could force the contextually relevant alternatives to *Bill* to be equal to the set of students, which would require that Bill himself be a student (as the set of alternatives to  $x$  always contains  $x$  as a member). However, this does not solve the problem generally: consider the below question-short answer pair, which *is* licensed, even though it does not meet the congruence condition.

- (148) a. Which students were dancing in the quad?  
 Semantic representation:  $\langle \{x | x \text{ is a student} \}, \lambda x.x \text{ was dancing in the quad} \rangle$

- b. Some Germans ~~were dancing in the quad~~.

Semantic representation:  $\langle \llbracket \text{some Germans} \rrbracket, \{ \llbracket \text{some Americans} \rrbracket, \llbracket \text{some Danes} \rrbracket, \llbracket \text{some Scots} \rrbracket, \dots \}, \lambda x.x \text{ was dancing in the quad} \rangle$

- c. Congruence condition: backgrounds should match (met), and what the question ranges over should be a subset of (or equal to) the focus value of the answer (not met; the set of students is not a subset of (or equal to) the focus alternatives  $\{ \llbracket \text{some Americans} \rrbracket, \llbracket \text{some Danes} \rrbracket, \llbracket \text{some Scots} \rrbracket, \dots \}$ ). So ellipsis should not be licensed here, contrary to fact.

So this question-based account moves us some of the way towards understanding some of the conditions on clausal ellipsis, it does not capture all of the data. One datum it does not capture is the ability of indefinites to license fragments. Intuitively, it seems to be the case that the reasons an indefinite-containing utterance like *someone here has the key to the liquor cabinet* licenses a fragment answer like *yeah, Mary* is that the antecedent utterance can be understood as raising an implicit question, roughly ‘who has the key to the liquor cabinet?’. Such implicit questions in discourse are often discussed under the rubric of the Question under Discussion or QUD (Roberts 2012/1996); I turn now to an analysis which bases the clausal ellipsis condition on the QUD.

### 3.3.2.2 Reich 2007: equivalence between QUD and focus value of elided clause

Reich 2007 proposes the following condition on fragment answers.<sup>30</sup>

- (149) In an elliptical clause  $\alpha$ ,  $\llbracket \alpha \rrbracket^F = \llbracket \text{QUD} \rrbracket$ , where  $\llbracket \alpha \rrbracket^F$  represents the focus-semantic value of  $\alpha$ , and the denotation of the Question under Discussion (QUD) is un-

---

<sup>30</sup>Reich also proposes that this condition can correctly describe the distribution of gapping sentences (e.g. *John ate fish and Mary  $\Delta$  beans*); I do not discuss this here. I have considerably abbreviated Reich’s condition here, abstracting away from his syntactic implementation. I have also used a formulation from Reich 2007 which is not quite his final conclusion; he refines the condition further, but I do not believe the refinements discussed are germane to the conclusions drawn here.

derstood as the Hamblin denotation of the question, i.e. the set of all possible answers. Non-focused material in  $\alpha$  can be phonologically deleted.

An example of how this works is given in (150).

- (150) a. Who left?  
 $[[\text{QUD}]] = \{\text{John left, Mary left, Sue left, ...}\}$
- b. Mary ~~left~~.  
 $[[\text{Mary left}]]^F = \{\text{John left, Mary left, Sue left, ...}\}$
- c.  $[[\text{QUD}]] = [[\text{Mary left}]]^F$ , therefore ellipsis licensed.

Imposing a semantic identity requirement between the Question under Discussion and the elided clause captures, as in Krifka 2006, the inability of fragments to find their antecedents in embedded clauses in interrogatives. On the assumption that an overt interrogative such as *Who did John say has the key to the liquor cabinet?* can only raise a Question under Discussion about what John said (and not about who *actually* has the key to the liquor cabinet), we predict that a fragment cannot pick up an embedded clause in an interrogative as antecedent, as shown below.

- (151) a. Who did John say has the key to the liquor cabinet?  
 $[[\text{QUD}]] = \{\text{John said Bill has the key to the liquor cabinet, John said Mary has the key to the liquor cabinet, John said Sue has the key to the liquor cabinet, ...}\}$
- b. \*Mary ~~has the key to the liquor cabinet~~.  
 $[[\text{Mary has the key to the liquor cabinet}]]^F = \{\text{Mary has the key to the liquor cabinet, Bill has the key to the liquor cabinet, Sue has the key to the liquor cabinet, ...}\}$
- c.  $[[\text{QUD}]] \neq [[\text{Mary has the key to the liquor cabinet}]]^F$ , therefore ellipsis not licensed.

The same is true of examples in which the question asks for an answer which is not provided by the fragment, as in the below case:

- (152) a. Why did John go to the party?  
 [[QUD]] = {John went to the party because he likes parties, John went to the party because he fancies someone there, John went to the party because he does everything Mary does, ... }
- b. \*Mary ~~went to the party~~ (and John does everything Mary does)  
 [[Mary went to the party]]<sup>F</sup> = {Mary went to the party, Bill went to the party, John went to the party, ... }
- c. [[QUD]] ≠ [[Mary went to the party]]<sup>F</sup>, therefore ellipsis not licensed.

This analysis also correctly predicts that indefinites and focused constituents suffice to license fragments. Intuitively, as discussed above, clauses containing indefinites can pragmatically be understood as requests for information about the identity of that indefinite. We could therefore see indefinites as raising implicit Questions under Discussion. The placement of focus is well known to presuppose a particular Question under Discussion: indeed treating focus placement is one of Roberts 2012/1996's main motivations for constructing the Question under Discussion framework. Reich's analysis therefore predicts that indefinites and focused elements should license fragments.

- (153) A: Somebody here has the key to the liquor cabinet.  
 (implicit QUD: *Who has the key to the liquor cabinet?*)  
 B: Yeah, Mary ~~has the key to the liquor cabinet~~.

- (154) JOHN has the key to the liquor cabinet.  
 (presupposes QUD: *Who has the key to the liquor cabinet?*)  
 B: No, Mary ~~has the key to the liquor cabinet~~.



We also capture the fact that double negatives, and content within appositives, do not license fragments. Such utterances are difficult to understand as information-seeking questions.<sup>31</sup> It feels natural to describe the situations in (155) as ones in which questions about the identity of the person being referred to by the indefinite is implicit or ‘pregnant’, with the speaker’s actions trying to prompt their interlocutor to answer these questions; but this is much less natural in (156), which seem like very peculiar scenarios, at least on that interpretation of what the speaker’s actions are meant to prompt the interlocutor to do.

- (155) a. (I hear that) somebody here has the key to the liquor cabinet.  
[Speaker raises eyebrows, looks hopefully at interlocutor]
- b. (I hear that) this is a guy who killed someone in cold blood.  
[Speaker raises eyebrows, looks hopefully at interlocutor]
- (156) a. (I hear that) it’s not the case that nobody here has the key to the liquor cabinet. [Speaker raises eyebrows, looks hopefully at interlocutor]
- b. (I hear that) John, who once killed someone in cold blood, is nice once you get to know him. [Speaker raises eyebrows, looks hopefully at interlocutor]

Similar facts also hold for quantifiers like *most* or *few*: for some reason, these do not easily raise implicit questions, as (157a) shows, and they also have difficulty licensing fragment answers, as (157b) (repeated from (115a)) shows.

- (157) a. (I hear that) most students came to class today. [Speaker raises eyebrows, looks hopefully at interlocutor]
- b. A: Most students came to class today.  
B: ?#Yeah, John, Mary, Bill, Anne, Tom and Sue.

---

<sup>31</sup>I will not attempt to explore here the pragmatics of why this should be so. AnderBois 2010, who notes the ellipsis facts concerning double negatives and content within appositives, offers a semantic explanation in the framework of Inquisitive Semantics.

Jeremy Hartman (p.c.) also points out to me that there are certain cases in which indefinites do not license fragments, if they are in a context which does not ‘raise a question’, such as within the antecedent of a conditional, as in (158).

(158) (Jeremy Hartman p.c.)

A: If someone has a peanut allergy, you shouldn’t serve them this food.

B: #Bill. (intended: Bill has a peanut allergy)

We can see that indefinites within conditionals do not seem to raise implicit questions by performing the ‘raised eyebrows’ test.<sup>32</sup> The below is a bizarre interaction:

(159) If someone has a peanut allergy, you shouldn’t serve them this food.

[Speaker raises eyebrows, looks hopefully at interlocutor]

This suggests that it is the ability to ‘raise questions’, in a way very similar to that discussed by AnderBois 2010, which is crucial to the licensing of fragments. However, Collins et al. 2014 note some interesting cases which appear to be counterexamples to the generalization that parentheticals cannot provide the antecedent for clausal ellipsis.

(160) (Collins et al. 2014’s (2))

[Context: Many important documents have gone missing.]

My assistant, who was accused of stealing an important paper, can’t work out which paper.

---

<sup>32</sup>Jeremy Hartman (p.c.) notes a correlation between this ability and the ability to refer back to the indefinite with a pronoun.

- (i) a. Someone here has the key to the liquor cabinet. He’s pretty sneaky.
- b. It’s not the case that no-one here has the key to the liquor cabinet. ??He’s pretty sneaky.

It seems as if the ability of an expression like *someone* to be referential (and therefore to be the referent of a pronoun) is important for the ability to ‘raise a question’, especially in the light of the fact that *most/few* have difficulty in licensing fragments, and that the indefinite within the conditional in (158), (159) (which is not referential) cannot raise a question. I can’t take this issue up in detail here, but it definitely warrants further investigation; as Hartman notes (p.c.), this behavior is reminiscent of Barbara Partee’s ‘marble’ sentences cited in Heim 1982: *I’ve found nine out of my ten marbles. ?It’s probably under the sofa.*

In (160), a sluiced clause finds its antecedent within a parenthetical. The same fact also seems to obtain for fragment answers, although the judgment is somewhat delicate.

- (161) A: My assistant, who was accused of stealing an important paper, is panicking.  
B: Yes, the secret accounts.<sup>33</sup>

Collins et al. 2014 suggest, however, that this can be understood as support for a QUD-based theory of clausal ellipsis (although they couch it in terms of Ginzburg & Sag 2000's proposal rather than an analysis like Reich 2007):

When a participant encounters a sluice which appears to take its antecedent from an appositive clause, they are able to make an inference that the speaker intends the MAX-QUD to be raised by the appositive clause, thereby licensing the sluice. Given the increased flexibility of a QUD model of sluicing, where participants can infer that a QUD takes its semantic content from an appositive clause, we expect participants to accept appositive antecedents to sluices. (Collins et al. 2014: sec. 4.3)

Given this, a QUD-based condition like Reich 2007's captures the first two of our 'three problems'. However, I argue that there are some cases that Reich's condition does not capture. Consider the below.

- (162) A: Who was dancing in the quad?  
B: Every German ~~were dancing in the quad~~.

Here, it looks as if an entire quantificational phrase *Every German* is in focus. I assume, following Rooth 1985, that the focus value of a phrase is compositionally built up via pointwise function application of the focus values of its parts. We have, then, the below focus value for *every*, *German*, and *every German*.

---

<sup>33</sup>This is better if the fragment is understood as a question: *The secret accounts?*

- (163) a.  $\llbracket \text{every} \rrbracket^F = \{ \llbracket \text{every} \rrbracket, \llbracket \text{some} \rrbracket, \llbracket \text{many} \rrbracket, \dots \}^{34}$   
 b.  $\llbracket \text{German} \rrbracket^F = \{ \lambda x.x \text{ is a German}, \lambda x.x \text{ is an American}, \lambda x.x \text{ is a student}, \dots \}$   
 c.  $\llbracket \text{every German} \rrbracket^F = \{ \text{every German}, \text{some Germans}, \text{many Germans}, \text{every American}, \text{some Americans}, \text{many Americans}, \text{every student}, \text{some students}, \text{many students}, \dots \}$   
 (pointwise function application on (a) and (b))

And so, for the question-answer pair in (162), we have the below:

- (164) a. Who was dancing in the quad?  
 $\llbracket \text{QUD} \rrbracket = \{ \text{John was dancing in the quad}, \text{Bill was dancing in the quad}, \text{Mary was dancing in the quad}, \dots \}$   
 b. Every German ~~were dancing in the quad~~.  
 $\llbracket [{}_F \text{Every German}] \text{ were dancing in the quad} \rrbracket^F = \{ \text{every German was dancing in the quad}, \text{some Germans were dancing in the quad}, \text{many Germans were dancing in the quad}, \text{every American was dancing in the quad}, \text{some Americans were dancing in the quad}, \text{many Americans were dancing in the quad}, \text{every student was dancing in the quad}, \text{some students were dancing in the quad}, \text{many students were dancing in the quad}, \dots \}$

But these sets of propositions are not equal. Take, for example, the proposition *some Germans were dancing in the quad*. This proposition is in the focus-semantic value of  $[{}_F \text{Every German}] \text{ was dancing in the quad}$ . However, this proposition is not to be found in the QUD in (164a). The proposition *Some Germans were dancing in the quad* can be understood as a long disjunction of propositions: *Hans was dancing in the quad or Stefan was dancing in the quad or Klara was dancing in the quad or . . .* But that disjunction isn't

---

<sup>34</sup>Some care needs to be taken in how this set of alternatives is generated. This will be discussed in detail in section 3.4.2 below.

in the QUD, which does not contain disjunctive propositions, but rather only propositions like *Hans was dancing in the quad*, *Stefan was dancing in the quad*, *Hans and Stefan were dancing in the quad*. . . . So some of the quantificational propositions in the focus-semantic value given in (164b) are not in the QUD given in (164a). As such, the ability to give an elliptical quantificational answer to a question like (164) casts doubt on Reich's precise formulation, where equality between the QUD and the focus-semantic value of the elided clause is required.

We might solve this problem by allowing *who* in (164a) to be polymorphic in type, and to range over quantifiers as well as entities, thereby giving us the below.

- (165) a. Who was dancing in the quad? (where *who* ranges over alternatives of type  $\langle et, t \rangle$ )
- [[QUD]] = {every German was dancing in the quad, some Germans were dancing in the quad, many Germans were dancing in the quad, every American was dancing in the quad, some Americans were dancing in the quad, many Americans were dancing in the quad, every student was dancing in the quad, some students were dancing in the quad, many students were dancing in the quad, . . . }
- b. Every German ~~were dancing in the quad~~.
- [[<sub>F</sub> Every German] were dancing in the quad]]<sup>F</sup> = {every German was dancing in the quad, some Germans were dancing in the quad, many Germans were dancing in the quad, every American was dancing in the quad, some Americans were dancing in the quad, many Americans were dancing in the quad, every student was dancing in the quad, some students were dancing in the quad, many students were dancing in the quad, . . . }

In such a case, we clearly do have equality. However, there are other examples which are felicitous, but which Reich's condition does not predict. These are cases which I will call

‘mismatch’ cases; cases in which the semantic type of the fragment answer seems to be different from the type which the question ranges over. Consider the below, for example.<sup>35</sup>

- (166) How many students came to the party?
- a. Only Mary.
  - b. John and Mary. (No-one else.)
  - c. John, Paul, George, Sarah, Mary and Helen.

Here, a *how many* degree question is answered with a fragment which does not state a number, but rather lists the students that came to the party. However, these are not predicted to be in the correct relationship on Reich’s theory, as shown below.

- (167) a. How many people came to the party?
- QUD = {one person came to the party, two people came to the party, three people came to the party, ... }
- b. John and Mary ~~came to the party~~.
- [[<sub>F</sub> John and Mary] came to the party]<sup>F</sup> = {John came to the party, Mary came to the party, John and Mary came to the party, Bill came to the party, ... }

Here, these two sets are not the same, for much the same reason as discussed above for the quantifier case; the proposition expressed by *two people came to the party* is a disjunctive one, verified by any situation in which any two people came to the party. No such proposition can be found in (167b), which contains propositions which all express that some *specific* (possibly plural) individuals came to the party.

We might again try to rescue the case in (167) by suggesting that *how many people* can range over quantificational alternatives (that is, it can project alternatives like *everyone came to the party*, *many people came to the party*, etc.), and that the focus alternatives

---

<sup>35</sup>I thank Jeremy Hartman for bringing this sort of example to my attention.

projected by *John and Mary* were also of quantificational type (perhaps adopting a view such as Montague 1973's, where all noun phrases are basically of type  $\langle et, t \rangle$ ). Then we might get matching between (167a) and (167b). Alternatively, we could imagine that there is a silent type  $\langle e, d \rangle$ <sup>36</sup> measure function applying to *John and Mary* in (167b), which would map plural individuals  $x$  into the number of individuals in  $x$ ;<sup>37</sup> this might be enough to ensure that the alternatives projected in (167b) ranged over degrees. However, there are some cases of 'mismatch' where such moves will not help, such as the below:

- (168) A: Exactly how fast was John driving?  
 B: Above 60 mph, anyway (but I don't know the exact speed, sorry).

The use of *exactly* in the question here is intended to rule out a reading in which the question could plausibly range over intervals (cf. Abrusán & Spector 2011); the intended reading is one in which the question ranges over (exact specifications of) degrees of speed.

- (169)  $\llbracket \text{Exactly how fast was John driving} \rrbracket = \{ \dots \text{John was driving at exactly 69 mph, John was driving at exactly 70 mph, John was driving at exactly 71 mph, } \dots \}$

But consider the focus-semantic value of the answer.

- (170)  $\llbracket \text{John was driving [}_F \text{ above 60 mph]} \rrbracket^F = \{ \text{John was driving above 60 mph, John was driving above 70 mph, John was driving below 60 mph, John was driving below 70 mph, } \dots \}$

I won't try to specify in detail how the focus-semantic value in (170) is arrived at compositionally, or the precise nature of the alternatives which are projected. However, whatever the answers to those questions, it seems clear that we will not have equality between the QUD and the focus-semantic value of the answer.

---

<sup>36</sup> $d$  is the type of degrees.

<sup>37</sup>Thanks to Elizabeth Bogal-Allbritten for suggesting this possibility to me.

To see this, note that the proposition *John was driving above 60 mph* must be in the set of focus alternatives in (170), as the ordinary semantic value of an expression is always a member of its focus-semantic value (Rooth 1985, 1992b). But the proposition *John was driving above 60 mph* is not to be found in the set in (169). Those propositions only specify *exact* speeds at which John was traveling, not lower bounds. It follows that the proposition *John was driving above 60 mph* is not in the denotation of the question *Exactly how fast was John driving?*. However, the focus-semantic value in (169) must contain the proposition *John was driving above 60 mph*. Therefore, the focus-semantic value shown in (169) is not equal to the question in (169); and we therefore predict that ellipsis should not be possible, contrary to fact.

These ‘mismatch’ cases constitute a problem for Reich 2007’s specific proposal. However, given the success of a QUD-based account in capturing the data concerning embedded clauses, and the data concerning which elements license fragments, I argue that the semantic condition on clausal ellipsis should indeed make reference to the Question under Discussion in the way that Reich proposes. In the following section, I will propose a condition which incorporates Reich’s insight, but which also draws on Merchant 2001, 2004’s e-GIVENness condition to solve the above problems.

### 3.4 QUD-GIVENness

#### 3.4.1 Solving the mismatch problem: ‘existentially closing the QUD’

Recall that e-GIVENness, as defined by Merchant 2001 (repeated here from (130)), involves an operation of existentially closure to derive a proposition from sentences that contain variables.

- (171) a. A clause may be elided if it is e-GIVEN.  
 b. A clause E is e-GIVEN if there is an antecedent clause A such that  $F\text{-clo}(E) \Leftrightarrow F\text{-clo}(A)$ .



- c. The focus closure (F-clo) of a clause is the denotation of that clause with all focused elements replaced by variables, and all variables (that is, traces plus focused elements which have been replaced) having been existentially closed.

This sort of existential closure operation in fact seems to solve the problem for a lot of ‘mismatch’ cases. For example, take the case in (166), repeated (slightly altered) here:

- (172) A: How many people came to the party?  
 B: Only Mary.

I assume that in a *how many* question, the trace left behind by movement of *how many* ranges over the type of degrees, and the focus

- (173) How many people [t many people came to the party]? — Mary ~~t came to the party~~.
- a.  $F\text{-clo}(A) = \exists d.d\text{-many people came to the party}$
  - b.  $F\text{-clo}(E) = \exists x.x \text{ came to the party}$

Here, there is mutual entailment between the focus-closure of the antecedent and the focus-closure of the elided clause; if there is a person who came to the party then there is a number  $d$  such that  $d$ -many people came to the party, and vice versa.<sup>38</sup> So e-GIVENness correctly predicts that ‘mismatch’ fragment answers should be allowed.

However, we saw above that e-GIVENness is not the right formulation of the condition on clausal ellipsis in general. In section 3.3.1.2 it was pointed out that the condition ‘if there is an antecedent clause’ is too liberal: not all potential antecedent clauses can actually serve to provide an antecedent for clausal ellipsis. This clause is also, in a way, too conservative:

---

<sup>38</sup>This is not strictly true if  $d$  is allowed to take the value zero. This will be discussed below.

it requires a (linguistic)<sup>39</sup> antecedent, but as noted in section 2.4.4, many cases of fragments do not require an antecedent.

Rather, the evidence gathered in section 3.3.2 suggests that the antecedent for clausal ellipsis should be located in the Question under Discussion. However, the QUD, as a question, is not the appropriate kind of object to be in a mutual entailment relationship with a proposition. While entailment relations can be defined over questions (i.e. between questions and other questions: Groenendijk & Stokhof 1989, Roberts 2012/1996), such relations are not defined over objects of different types. Reich 2007's approach calls for equality between the QUD and the focus-semantic value of the elided clause, which would be defined, but does not deliver the correct results in cases like (172), as discussed in the preceding section.

What we want is a way to reap the benefits which existential closure provides for us in cases like (172). There is a simple transformation which can be applied to the QUD, understood as having a Hamblin denotation (that is, as a set of propositions which are possible answers to the question), which has the same effect as existential closure: namely, taking the union, or disjunction, of all the propositions within the set that the QUD denotes. (174) illustrates this operation for the question *Who left?*. In the toy model in (174), the only people are John, Mary and Sue; John left in worlds  $w_0, w_1, w_2$ , Mary left in worlds  $w_0, w_3$ ; and Sue left in worlds  $w_1, w_2, w_4$ . (We could say that in world  $w_5$ , nobody left.)

- (174) a.  $\llbracket \text{who left} \rrbracket = \{\text{John left, Mary left, Sue left}\}$   
 $= \{\{w : \text{John left in } w\}, \{w : \text{Mary left in } w\}, \{w : \text{Sue left in } w\}\}$   
 $= \{\{w_0, w_1, w_2\}, \{w_0, w_3\}, \{w_1, w_2, w_4\}\}$
- b.  $\bigcup \llbracket \text{who left} \rrbracket = \bigcup \{\{w : \text{John left in } w\}, \{w : \text{Mary left in } w\}, \{w : \text{Sue left in } w\}\}$

---

<sup>39</sup>On the fact that e-GIVENness requires a truly linguistic antecedent, contra Merchant 2004, see section 3.6.1.

$$\begin{aligned}
&= \bigcup \{ \{w_0, w_1, w_2\}, \{w_0, w_3\}, \{w_1, w_2, w_4\} \} \\
&= \{w_0, w_1, w_2, w_3, w_4\}
\end{aligned}$$

The result of taking the union of the set of propositions denoted by the question is to give us the proposition which is the disjunction of those propositions, that is, the proposition ‘that John left or Mary left or Sue left’; or, to put it another way, the set of all worlds in which at least one of John, Mary or Sue left. To put it yet another way, the proposition obtained by taking the union of the question *who left* is the existential statement  $\exists x.x$  left, as an existential statement is equivalent to a long disjunction. This sort of existential statement is exactly the sort of statement which Merchant’s e-GIVENNESS condition creates by f-closing an antecedent.

In fact, we can generally rewrite the Merchant 2001/Schwarzschild 1999 notion of F-closure in this way.<sup>40</sup> The operation of taking a proposition (properly speaking: a syntactic phrase marker whose denotation is a proposition), replacing all its focus-marked phrases with variables, and existentially closing the result, is identical in effect to taking the union of the focus-semantic value (as defined by Rooth 1985, 1992b) of the proposition, as shown below.<sup>41</sup>

$$(175) \quad \llbracket [F \text{ John}] \text{ left early} \rrbracket = \text{that John left early}^{42}$$

---

<sup>40</sup>Or, at least for the purposes for which Merchant uses it and for which I will use it. We are only concerned here with F-closing propositions and questions, that is, semantic objects whose focus-semantic values are sets of propositions, type  $\langle st, t \rangle$ . In Schwarzschild 1999, F-closure is an operation which applies to all semantic types. The rewording of F-closure in terms of set union which I give here would, I believe, be *defined* over all set types (objects of type  $\langle \sigma, t \rangle$ , whose focus value would be a set of sets, type  $\langle \langle \sigma, t \rangle, t \rangle$ ), but whether it would give sensible or desirable results if applied to something other than a proposition or question is not something I have tried to investigate in detail.

<sup>41</sup>The two may not in fact be completely identical, depending on how traces are interpreted. Merchant 2001’s condition treated traces as variables, and existentially closed them. However, I think the set-union version does not lose anything by not doing this.

<sup>42</sup>I abbreviate the proposition ‘ $\lambda w.$  John left early in  $w$ ’ in this way for readability; where it will not cause confusion, I will also drop the ‘that’, writing ‘ $\lambda w.$  John left early in  $w$ ’ just as ‘John left early’.

- (175)  $\llbracket [F \text{ John}] \text{ left early} \rrbracket^F = \{ \text{that John left early, that Mary left early, that Bill left early, } \dots \}$
- (175)  $F\text{-clo}(\llbracket [F \text{ John}] \text{ left early} \rrbracket) = \exists x.x \text{ left early}$
- (175)  $\bigcup \llbracket [F \text{ John}] \text{ left early} \rrbracket^F = \text{that John left early or that Mary left early or that Bill left early or } \dots$   
 $= \exists x.x \text{ left early}$

Rewriting focus-closure in this way allows us to remove F-closure as a primitive operation. It also gives us a way of formulating a version of the e-GIVENNESS condition which makes reference to the QUD, which I provide in (176). In order to avoid confusion with Merchant's original definition of e-GIVENNESS, I rechristen the condition as QUD-GIVENNESS. It can be immediately seen that (176) is almost the same as Reich 2007's formulation, except that the QUD and the focus value of the elided clause have undergone the set union operation.

- (176) QUD-GIVENNESS (*first pass*)  
 A clause E is QUD-GIVEN iff  $\bigcup \text{QUD} \Leftrightarrow \bigcup \llbracket [E] \rrbracket^F$ .

I propose that non-focused elements of a clause which is QUD-GIVEN can be elided, in much the same way that e-GIVENNESS functions in Merchant's proposal. A simple example of how this works is shown in (177).

- (177) Who left? — Mary ~~left~~.
- a.  $\text{QUD} = \llbracket [\text{Who left?}] \rrbracket = \{ \text{Mary left, Bill left, Sue left, } \dots \}$
- b.  $\bigcup \text{QUD} = \bigcup \{ \text{Mary left, Bill left, Sue left, } \dots \}$   
 $= \text{Mary left or Bill left or Sue left or } \dots$   
 $= \exists x.x \text{ left}$
- c.  $\bigcup \llbracket [F \text{ Mary}] \text{ left} \rrbracket^F = \exists x.x \text{ left}$
- d.  $\bigcup \text{QUD} \Leftrightarrow \bigcup \llbracket [E] \rrbracket^F$ , so ellipsis is licensed.

We see that this condition functions to license the ‘simple’ cases of fragments as responses. I want to argue that adding disjunction to Reich 2007’s formulation allows us to capture the felicity of the below exchanges.

- (178) How many students came to the party?
- a. Only Mary.
  - b. John and Mary. (No-one else.)
  - c. John, Paul, George, Sarah, Mary and Helen.

QUD-GIVENNESS correctly predicts that such ellipsis should go through, as shown below.

- (179)
- a. How many people came to the party? – John and Mary.
  - b. QUD = {one person came to the party, two people came to the party, three people came to the party, ... }
  - c.  $\bigcup \text{QUD} = \exists d. d\text{-many people came to the party}$
  - d.  $E = [\text{F John and Mary}] \text{ came to the party.}$
  - e.  $\bigcup [[E]]^F = \exists x. x \text{ came to the party}$
  - f.  $\bigcup \text{QUD} \Leftrightarrow \bigcup [[E]]^F$  (if there is a person who came to the party then there is a number  $d$  such that  $d$ -many people came to the party, and vice versa). So ellipsis is licensed.<sup>43</sup>

---

<sup>43</sup>As mentioned above, there is a problem here in that the right-to-left version of this entailment does not strictly go through if  $d$  is allowed to take the value zero. I have to assume that this is not permitted. I tentatively suggest that *zero* is not an accessible alternative in degree questions. In section 3.4.2, I will argue that negative quantifiers such as *no*, *few* are not accessible alternatives for quantifiers, because they are underlyingly sentential negation plus existential quantifiers (e.g.  $no = \neg + some$ ); perhaps *zero* is similarly not ‘really’ a word, but one possible spellout of sentential negation plus ‘(even) one’. As support for this, note that *zero* gives rise to ‘split scope’ readings (cases where the negation and the existential are interpreted with different scopes with respect to intensional verbs) in the same way as *no* does, as De Clercq 2011 points out:

- (i) The company need fire zero employees. (= It is not necessary for the company to fire any employees.)  
 $[\neg [\text{need} [\text{the company} [\text{fire} [(even) \text{one employee}]]]]]$

However, De Clercq also points out that in other respects, *zero* behaves differently from *no* (see also Postal 2003); but it is beyond the scope of this work to enter into details here.

Other kinds of ‘mismatch’, such as the below (repeated from (168)), can be given a similar analysis.

(180) A: Exactly how fast was John driving?

B: Above 60 mph, anyway (but I don’t know the exact speed, sorry).

(181) a. Exactly how fast was John driving?

b. QUD = { ... John was driving at exactly 69 mph, John was driving at exactly 70 mph, John was driving at exactly 71 mph, ... }

c.  $\bigcup \text{QUD} = \exists d. \text{ John was driving at exactly } d \text{ mph}$

d. E = John was driving [<sub>F</sub> above 60 mph].

e.  $[[E]]^F = [[\text{John was driving } [\text{F above 60 mph}]]]^F = \{\text{John was driving above 60 mph, John was driving above 70 mph, John was driving below 60 mph, John was driving below 70 mph, ...}\}$

f.  $\bigcup [[E]]^F = \text{there is some interval of speed within which John’s speed lies (above 60 mph, below 70 mph, etc.)}^{44}$

$\bigcup \text{QUD} \Leftrightarrow \bigcup [[E]]^F$  (if there is an interval within which John’s speed lies, then he was driving at a particular speed, and vice versa). So ellipsis is licensed.

Given this reasoning, we might worry about overgeneration. In particular, it is perhaps surprising that the below short answer is degraded.

(182) Who came to the party? — ??Four people ~~came to the party~~.

(183) a.  $\bigcup \text{QUD} = \exists x. x \text{ came to the party}$

b.  $\bigcup [[E]]^F = \exists d. d\text{-many people came to the party}$

Given that we just reasoned that (183a)  $\Leftrightarrow$  (183b), it is surprising that the ellipsis in (182) is not licensed. Furthermore, there is something slightly suspicious about cases like (180)

---

<sup>44</sup>Formally:  $\exists D_{\langle d,t \rangle}. \exists d. d \in D \ \& \ \text{John was driving at } d \text{ mph.}$

(degree question/interval answer); to make these felicitous, there has to be a certain amount of ‘surrounding material’. They are somewhat degraded without this, as (184b) shows.

- (184) A: Exactly how fast was John driving?
- a. B: Above 60 mph, anyway (but I don’t know the exact speed, sorry).
  - b. B: ??Above 60 mph.

There are also other cases where it looks like our logic should tell us that QUD-GIVENNESS should apply, but fragments are impossible:

(185) How fast did he eat? — \*Chips.

- (186) a.  $\bigcup \text{QUD} = \exists d. \text{ he ate } d\text{-fast}$   
b.  $\bigcup [\text{E}]^F = \exists x. \text{ he ate } x$

In (186), the two propositions created do mutually entail each other (if he ate at a particular speed, then he ate something, and vice versa); so the infelicity of (185) is perhaps unexpected.

My argument will be here that the reason for the infelicity of these cases is not due to the ellipsis condition; it is because even the full sentences are not good as answers in these cases, as, for example, the full clausal version of (182) shows.

(187) Who came to the party? — ??Four people came to the party.

I argue that the ellipsis condition is indeed met in cases like (182). The reason for its infelicity is that it is not a cooperative answer to the question asked. The *who*-question asks for identifiers – names or salient properties. However, the degree answer does not address this question (in a non-technical sense) – it simply gives a number. As such it is not pragmatically cooperative, and (187) (and, a fortiori, (182)) is infelicitous for that reason. The inverse situation, the one in (178), is however cooperative. Giving a list answer to a degree question does not answer the question directly. However, the hearer can count the

number of names given, and – on the usual assumption that speakers give full, exhaustive answers – the hearer can infer the answer to the degree question in that way. The answers in (178) are therefore felicitous; and the ellipsis condition is met, so ellipsis is also felicitous in these cases. Notice further that if the people are subsequently enumerated, both the long answer and the elliptical one are felicitous.

- (188) Who came to the party?
- a. Four people came to the party – John, Bill, Sue and Mary.
  - b. Four people – John, Bill, Sue and Mary.

We can tell a similar story about the infelicity of cases like (184b). Note that here, too, the full clausal answer is degraded without ‘surrounding material’.

- (189) Exactly how fast was John driving?
- a. B: He was driving above 60 mph, anyway (but I don’t know the exact speed, sorry).
  - b. B: ??He was driving above 60 mph.

B’s answer in (189b) is willfully avoiding the ‘exactly’ part of the question, and is therefore degraded without the kind of ‘apologetic’ material in (189a). However, this is a matter of pragmatics which is unrelated to the ellipsis condition.

The same sort of story applies to cases like (185). The fragment is bad, but so is the full clause, because it isn’t a sensible answer to the question quite apart from the QUD-GIVENNESS condition.

- (190) a. How fast did he eat? — #Chips.  
b. How fast did he eat? — #He ate chips.

In principle, then, the ellipsis condition can freely apply whenever the QUD-GIVENNESS condition is met. However, the clause which is being elided has to be a pragmatically



sensible answer in the first place; and this requirement will serve to rule out cases where it looks like QUD-GIVENness might overgenerate.

We see, then, that adding disjunction to Reich 2007's proposed condition on ellipsis correctly predicts that cases of 'mismatch' fragment answers (entity/degree, exact degree/degree interval, etc.), should be grammatical.

### 3.4.2 Quantificational fragment answers

I argue that – when combined with some assumptions about the alternatives projected by quantifiers – adding disjunction to the ellipsis condition has the further benefit of solving the problem of quantificational answers, as below.

(191) Who left? — Every German ~~left~~.

In section 3.3.2.2 above, it was argued that Reich 2007's condition runs into problems with such answers. If set union/disjunction is 'added to both sides' of the condition, as proposed here, then these problems are solved, and examples like (191) are correctly predicted to be grammatical. However, showing this in detail will require a detour into the details of the alternatives projected by quantificational phrases.

On the most immediately obvious story, adding disjunction to the mix in fact seems to cause new problems. We might suppose that the focus value of a quantifier like *every* is the set of quantifiers (192a), in which case the focus value of the quantificational phrase like *every German* will be (192b), and the focus value of the phrase  $[_F \textit{Every German}] \textit{came to the party}$  will be (192c).

- (192) a.  $\llbracket \textit{every} \rrbracket^F = \{Q \mid Q \in D_{\langle \textit{et}, \langle \textit{et}, \textit{t} \rangle \rangle}\}$   
 b.  $\llbracket \textit{every German} \rrbracket^F = \{Q(P) \mid Q \in D_{\langle \textit{et}, \langle \textit{et}, \textit{t} \rangle \rangle}, P \in D_{\langle \textit{e}, \textit{t} \rangle}\}$   
 c.  $\llbracket [_F \textit{every German}] \textit{left} \rrbracket^F = \{Q(P)(\textit{left}) \mid Q \in D_{\langle \textit{et}, \langle \textit{et}, \textit{t} \rangle \rangle}, P \in D_{\langle \textit{e}, \textit{t} \rangle}\}$

The problem is that taking the disjunction of (192c) leads to a tautology. To see this, we can look at a subset of (192c), as in (193).

(193) {some Germans left, no Germans left}

Taking the disjunction of these propositions, we get the proposition in (194):

(194) Some Germans left or no Germans left.

But (194) is clearly a tautology; it will always be true that either some Germans left or none did. As the disjunction of a tautology with any other proposition will result in a tautology, then we can see that the disjunction of the propositions in (192c) – which contains (193) as a subset – will also result in a tautology. The problem is that a tautology does not entail anything (except other tautologies). So we predict that quantificational answers should be impossible, as shown below.

(195) Who left? — Every German ~~left~~.

a. QUD =  $\llbracket$ Who left? $\rrbracket$  = {Mary left, Bill left, Sue left, ... }

b.  $\bigcup$ QUD =  $\bigcup$ {Mary left, Bill left, Sue left, ... }  
= Mary left or Bill left or Sue left or ...  
=  $\exists x.x$  left

c.  $\bigcup \llbracket$ [<sub>F</sub> Every German] left $\rrbracket^F$  =  $\top$  (i.e. tautologous, as shown above)

d.  $\bigcup \llbracket$ [<sub>F</sub> Every German] left $\rrbracket^F \not\approx \bigcup$ QUD  
so ellipsis predicted not to be licensed.

We might say that *who* in (195a) can range over quantifiers too, and so the union of the QUD would be the same as (192c), namely a tautology. Then mutual entailment between  $\bigcup$ QUD and  $\bigcup \llbracket$ [<sub>E</sub>] $\rrbracket^F$  would go through (two tautologies would entail each other). However, in that case, the semantic condition would be left without any ‘bite’; it would not rule out cases that we want the semantic condition to rule out. It would predict, for example, that the below case should go through.

(196) Who did John say left? — #Every German ~~left~~ (but I don’t know what John said)



interpreted as meaning that redness is the only property that Mary's hats have. That clearly cannot be correct. Rather, the alternatives to *red* in (198) must range over colors; that is, the domain of alternative properties is sortally restricted.

The question then arises of how the alternatives are restricted. Blok & Eberle 1999 argue that examples like (198) shows that focus alternatives are fundamentally drawn from the *lexicon*; the alternatives in cases like (198) range over words, and possibly certain restricted subdomains of the lexicon, such as (for example) color words. This ties in with more recent work by Fox & Katzir 2011 in which they argue that focus alternatives are computed with reference to syntactic structure and the lexicon, not (just) by looking at possible alternatives in the semantics. Concretely, Fox and Katzir (following Katzir 2007) propose that an item  $\alpha$ 's alternatives are all the possible items of the same semantic type as  $\alpha$ , and which are no more *structurally complex* than  $\alpha$ . Roughly, an item  $\beta$  is no more structurally complex than  $\alpha$  only if  $\alpha$  can be transformed into  $\beta$  via only processes of lexical substitution and 'reduction' in  $\alpha$ 's parse tree (i.e. 'pruning'/deleting branches in  $\alpha$ ; see Katzir 2007 for the full definition of structural complexity). Katzir 2007's concern is the calculation of alternatives relevant for scalar implicatures; the aim is to ensure that *all* is an alternative to *some* (therefore *some* implicates *not all*), but that *some but not all* is not an alternative to *some* (otherwise the above implicature would not arise). The structural complexity metric solves this problem: *some but not all* is more structurally complex than *some*, and so is not an alternative. Fox & Katzir 2011 extend this method of calculating alternatives to focus interpretation.

If we adopt this view, then the alternatives to a quantifier like *every* are all the quantificational words in the lexicon (of equal structural complexity, that is excluding complex quantifiers like *some but not all*), not the larger set of all logically possible quantifiers.

(199)  $\llbracket \text{every} \rrbracket^F = \{\text{every, many, some, few, no, } \dots \}$

This move, however, is not quite enough to solve the tautology problem. The basic problem is that there are still negative quantifiers in the set in (199), which lack existential import. When propositions containing quantifiers like *few Germans*, *no Germans* are disjoined with those containing the quantifier *some Germans*, tautology again results.

- (200) a. Some Germans left or no Germans left.  
 b.  $[\exists x.\text{german}(x) \ \& \ \text{left}(x)] \vee [\neg\exists x.\text{german}(x) \ \& \ \text{left}(x)]$
- (201) a. Some Germans left or few Germans left.  
 b.  $[\exists x.\text{german}(x) \ \& \ \text{left}(x)] \vee [\neg\exists x. |x| > c \ \& \ \text{student}(x) \ \& \ \text{left}(x)]$   
 where  $c$  is a contextually provided constant.<sup>45</sup>

That (200) is a tautology is obvious. To see that (201) is, note that the left disjunct is verified by there being one or more Germans that left, and the right disjunct is verified by there being no Germans that left. (*Few Germans left* normally communicates that some did, but this is an implicature, not part of the truth-conditional meaning of *few*.) So the two disjuncts taken together cover every possible situation, and as such (201) is a tautology.

To ensure that this problem does not arise, we essentially need to ensure that quantifiers which lack existential import – negative quantifiers such as *few* or *no* – do not appear in the focus alternative set of a quantifier. To accomplish this, I adopt a proposal common in the literature (see e.g. Bech 1955/1957, Jacobs 1980, Kratzer 1995, Rullman 1995, Penka 2011; see Penka 2012 for a recent survey article): the suggestion that the negative part of these quantifiers is separate from the quantificational part. One reason to believe that this is true comes from verb phrase ellipsis constructions: as Johnson 2001 points out, a phrase which contains a negative indefinite like *no* can serve as antecedent for an ellipsis site which must contain a positive indefinite.

---

<sup>45</sup>This is the ‘cardinality’ reading of *few* rather than the ‘proportional’ reading (Partee 1989), but the same point would be made by the proportional reading.

(202) (Johnson's (107))

I could find no solution, but Holly might (~~find a solution~~/\*find no solution).<sup>46</sup>

The above-cited authors argue that negative quantifiers like *no* are not monomorphemic but rather are the spellout of their positive counterparts in construction with sentential negation. There are various different proposals for how this spellout is achieved (see the references listed above for proposals), but what is important for our purposes is the negative quantifiers are not separately listed in the lexicon. Negative quantifiers such as *no*, *few* have syntax and semantics as shown below.

(203) a. No German left.

b.  $[\neg [\text{TP} [\text{DP a German}] [\text{VP left}]]]$ <sup>47</sup>

c.  $\neg \exists x. \text{german}(x) \ \& \ \text{left}(x)$

(204) a. Few Germans left.

b.  $[\neg [\text{TP} [\text{DP many Germans}] [\text{VP left}]]]$

c.  $\neg \exists x. |x| > c \ \& \ \text{german}(x) \ \& \ \text{left}(x)$

where *c* is a contextually provided number.

Once we have accepted that negative quantifiers don't have an 'independent' existence, but are rather versions of their positive variant when these occur in construction with sentential negation, then we have the tools to tackle the problem at hand. Following Fox & Katzir 2011, we can assume that the focus alternatives projected by a word depend on the other words in the lexicon of a given language; the alternatives are alternatives to the word (not

---

<sup>46</sup>The interaction of negative indefinites and negative polarity items with ellipsis is discussed in great detail in van Craenenbroeck & Temmerman 2010, Temmerman 2013a, Merchant 2013 (and is first discussed in Sag 1976:157f.) Temmerman 2013a in particular argues for a decompositional view of negative quantifiers to explain certain puzzles involving ellipsis and quantifier scope.

<sup>47</sup>I am equivocating here on the precise position of negation. It's clear, however, that it has to be interpreted very high, above modal verbs for example: in cases like *The company need fire no employees* (Potts 2000), negation scopes above the modal verb *need*.

just, for example, any logically possible alternative of the same type). It then follows that the alternatives to a quantifier like *every* will include other quantificational words like *many*, *some*, *half*, *most* etc. Crucially, however, I argue that the alternatives will *not* include negative quantifiers like *no* or *few*. These are not ‘independent’ words in the lexicon, but rather just the same words as their positive counterparts (although pronounced differently when in construction with sentential negation). We have then the below.

- (205) a.  $\llbracket \text{every} \rrbracket^F = \{ \text{every, some, many} \dots \}$   
 b.  $\llbracket \text{every German} \rrbracket^F = \{ \text{every German, some Germans, many Germans, every American, some Americans, many Americans, every student, some students, many students,} \dots \}$   
 c.  $\llbracket [\text{F every German}] \text{ left} \rrbracket^F = \{ \text{every German left, some Germans left, many Germans left, every American left, some Americans left, many Americans left, every student left, some students left, many students left,} \dots \}$

But now note that the disjunction of (205c) is no longer a tautology. We have the below:

- (206)  $\bigcup \llbracket [\text{F every German}] \text{ left} \rrbracket^F = \text{every German left or some Germans left or many Germans left or every American left or some Americans left or many Americans left or every student left or some students left or many students left or} \dots$

(206) is a fairly weak statement, but it is not tautologous. (206) is verified just in case someone of some description left, that is, it reduces to (207).<sup>48</sup>

- (207)  $\exists x.x \text{ left}$

But this is exactly what we want for our ellipsis condition.

---

<sup>48</sup>Very strictly speaking, sentences like *every student left* also lack existence entailments; the formula ‘ $\forall x.\text{student}(x) \Rightarrow \text{left}(x)$ ’ is verified if no students exist. However, universal quantifiers of this kind have existence *presuppositions*; they presuppose that their domain is non-empty (see e.g. Geurts 2007). That’s enough to ensure that (206) requires someone to exist in order to be verified.

- (208) Who left? — Every German ~~left~~.
- a. QUD =  $\llbracket$ Who left? $\rrbracket = \{\text{Mary left, Bill left, Sue left, } \dots\}$
  - b.  $\bigcup \text{QUD} = \bigcup \{\text{Mary left, Bill left, Sue left, } \dots\}$   
 $= \text{Mary left or Bill left or Sue left or } \dots$   
 $= \exists x.x \text{ left}$
  - c.  $\bigcup \llbracket$ [<sub>F</sub> Every German] left $\rrbracket^F = \exists x.x \text{ left}$  (as shown above)
  - d.  $\bigcup \llbracket$ [<sub>F</sub> Every German] left $\rrbracket^F \Leftrightarrow \bigcup \text{QUD}$   
 so ellipsis correctly predicted to be licensed.

We see then that adding disjunction to the ellipsis condition has the positive effect that it rules in quantificational fragment answers.

### 3.4.3 Advantages inherited from Reich's analysis

As QUD-GIVENNESS is otherwise identical to Reich 2007's proposal, however, it inherits all the benefits which Reich's analysis has. As a QUD-based analysis, it predicts, for example, that those indefinites and focused elements which can raise implicit QUDs should be able to license ellipsis. In both of the below cases, for example, the implicit QUD is *Who left?*, which license the ellipsis in *Mary ~~left~~* just as the QUD which is explicitly posed by *Who left* in (208) does.

- (209) a. Someone left. — Yeah, Mary ~~left~~.
- b. BILL left. — No, Mary ~~left~~.

This approach also predicts the failure of embedded clauses within interrogatives to provide the antecedents for clausal ellipsis, in much the same way as Reich 2007's analysis does; the union of the QUD will only ever provide an antecedent proposition which corresponds to the matrix clause, as shown below.



- (210) Who did John say has the key to the liquor cabinet?
- a. QUD = {John said Mary has the key, John said Bill has the key, ... }
  - b.  $\bigcup$ QUD =  $\exists x$ . John said that  $x$  has the key to the liquor cabinet

Given (210b), only the first of the two below possibilities for an elided clause will be licensed, which is a good prediction.

- (211) a. ~~John said that Mary has the key to the liquor cabinet~~
- b.  $\bigcup$ [(211a)]<sup>F</sup> =  $\exists x$ . John said that  $x$  has the key to the liquor cabinet  
which is in a mutual entailment relation with  $\bigcup$ QUD, therefore ellipsis licensed.
- (212) a. ~~Mary has the key to the liquor cabinet~~
- b.  $\bigcup$ [(212a)]<sup>F</sup> =  $\exists x$ .  $x$  has the key to the liquor cabinet  
which is *not* in a mutual entailment relation with  $\bigcup$ QUD, therefore ellipsis not licensed.

We also predict correctly that examples like the below do not work.

- (213) Why did John go to the party? — #~~Mary went to the party~~ (and John does everything Mary does)
- a. QUD = {John went to the party because he likes parties, John went to the party because he fancies someone there, John went to the party because he does everything Mary does, ... }
  - b.  $\bigcup$ QUD =  $\exists x$ . John went to the party for reason  $x$
  - c.  $\bigcup$ [[<sub>F</sub> Mary] went to the party]<sup>F</sup> =  $\exists x$ .  $x$  went to the party  
which is not in a mutual entailment relation with  $\bigcup$ QUD, therefore ellipsis not licensed.

So we see that QUD-GIVENness, a refinement of Reich 2007’s proposal, captures a number of facts about clausal ellipsis. However, we have not yet solved the problem of presupposition inheritance (that is, the infelicity of the exchange *Which students came to the party? – #Bill and Mary, but they’re not students*). In the following section, I propose a way in which presupposition inheritance can be captured in the present system.

### 3.4.4 Presupposition inheritance and domain restriction

Let us first note that QUD-GIVENness does not immediately predict the phenomenon of ‘presupposition inheritance’. In fact, the situation is worse: as it stands, it does not seem as if QUD-GIVENness predicts *any* short answer to constituent questions containing an NP restrictor to be grammatical, as (214) shows.

(214) Which students were dancing in the quad? — John and Mary ~~were dancing in the quad~~.

a.  $\text{QUD} = \{\text{John was dancing, Mary was dancing, John and Mary were dancing, Susan was dancing, } \dots \}$

b.  $\bigcup \text{QUD} = \exists x \in \text{student}.x \text{ was dancing in the quad}$

c.  $\bigcup [[E]]^F = \exists x.x \text{ was dancing in the quad}$

which is not in a mutual entailment relation with  $\bigcup \text{QUD}$ , therefore ellipsis not licensed.

The problem is that the existential closure in (214c) should have its domain restricted to students, but nothing in the analysis so far lets us do that.

It is well-known, however, that in general focus alternatives can be restricted by context, as already discussed in section 3.4.2. Take the below example (Krifka 2004’s (9)):

(215) A: Did Mary talk to John and Bill?

B: Mary only talked to [<sub>F</sub> Bill].

Here, there is a reading of B's utterance in which Mary could have talked to many people, but out of John and Bill, she only talked to Bill. That is, the alternatives which *only* is sensitive to are only {John, Bill}, i.e. those set up by the question. The focus alternatives projected by *Bill* here, then, have to be contextually restricted. Rooth 1992b provides a way of doing this; I will not concern myself with the method via which it is done here, just relying on the fact that clearly some mechanism of contextual restriction of focus alternatives is necessary.

However, once we agree that focus alternatives can be contextually restricted, then (214) ceases to be a problem. If the focus alternatives projected by *John and Mary* in the answer can be restricted only to students, then we can allow the below:

- (216) Which students were dancing in the quad? — John and Mary ~~were dancing in the quad.~~
- a. QUD = {John was dancing, Mary was dancing, John and Mary were dancing, Susan was dancing, ... }
  - b.  $\bigcup \text{QUD} = \exists x \in \text{student}.x \text{ was dancing in the quad}$
  - c.  $[[E]]^F = \{\text{John was dancing, Mary was dancing, John and Mary were dancing, Susan was dancing, ...}\}$   
(focus alternatives contextually restricted to range only over students)
  - d.  $\bigcup [[E]]^F = \exists x \in \text{student}.x \text{ was dancing in the quad}$

Here, there is mutual entailment, and so we predict ellipsis to go through just in case the domain of alternatives which *John and Mary* projects is contextually restricted only to students. This will require that John and Mary are themselves students. As the set of focus alternatives to  $\alpha$  always contains  $\alpha$  as a member, then if the set of focus alternatives to *John and Mary* only contains students, then John and Mary must be students (as John and Mary must be a member of that set of focus alternatives). That is why the below dialogue is incoherent.

(217) A: Which students were dancing in the quad?

B: #John and Mary, but they're not students.

We therefore predict 'presupposition inheritance' as a side effect of the strict mutual entailment condition on ellipsis. The alternatives which the answer ranges over have to be contextually restricted so that they are identical to those projected by the question, which requires that the denotation of the answer has to be within the question: if it is not, the ellipsis condition cannot be met.

By contrast, long (clausal) answers, or answers containing verb phrase ellipsis, do not have to fulfill such a condition. There is no requirement that the focus-semantic value of a full clausal answer be contextually restricted so that it matches the QUD, and so, the following dialogue is acceptable.

(218) A: Which students were dancing in the quad?

B: John and Mary were (dancing in the quad), but they're not students.

A more interesting case is the contrast between the below answers.

(219) a. A: Which students were dancing in the quad?

B: The Germans were dancing in the quad.

b. A: Which students were dancing in the quad?

B: The Germans.

(219a) has a reading on which B is 'correcting' A's presupposition, and telling A that, in fact, the correct way of characterizing the dancers in the quad is as Germans, not students. There is also another reading of B's utterance in which B is telling A that the students that were dancing in the quad were the German students. That is, on this reading, *the Germans* is being understood as *the German students*.<sup>49</sup> Crucially, however, the short answer in

---

<sup>49</sup>There is, however, a preference for the short answer *The Germans* to convey this meaning, and the answer containing verb phrase ellipsis (*The Germans were*) is better than the full clausal answer. I suspect

(219b) *only* has the latter of these readings, that is, the one in which *the Germans* is read as meaning *the German students*. It cannot have the ‘corrective’ reading which B’s answer in (219a) can have. This comes out clearly in (220).

(220) Milling around in the quad are some American faculty, some American students, some German faculty, and some German students. The German students start dancing, although the German faculty refrain.

A: Which students were dancing in the quad?

B: The Germans.

Here, B’s utterance has no false reading, one in which *the Germans* refers to the whole collectivity of German students and faculty; it can only be taken as referring to the German students alone.

Why does this difference between full clausal answers and fragment answers obtain? To understand this, we first need to understand how *the Germans* can be read as meaning *the German students* even in full clausal cases like (219a). The answer comes from *domain restriction*. It is very well known that quantificational, definite, and other expressions containing NPs must have their domains ‘restricted’ in some way (see, among many others, Westerståhl 1985, von Stechow 1994, Stanley & Szabó 2000, Martí 2003, Kratzer 2004, and references cited therein). For example, in the utterance below, *every student* does not mean every student in the entire world. Rather, it refers only to the students in the room.

(221) I walk into a classroom containing 30 students, all of whom are asleep. I can report this situation later by uttering:

Every student was asleep.

---

this preference comes about because the full clausal answer is very marked if the short or VPE answers are possible, and so may more easily give rise to a ‘corrective’ reading (see some discussion to this effect in Jacobson 2013). I think it is clear, though, that the long answer is still felicitous in this scenario, i.e. the reading of B’s answer in which B means ‘the German students’ by ‘the Germans’ does exist.

Here, the DP *every student* has to be interpreted somehow as *every student who was in the classroom*. There is considerable debate in the literature concerning the precise mechanisms by which this is done. I won't try to pick among them here, referring the reader to the references cited above for details. What is important for our purposes is that, in some way, the translation of an expression like *the Germans* has to be not (222a), but (222b).<sup>50</sup>

(222)    [[the Germans]]

- a.     $\neq \iota x.\text{german}(x)$
- b.     $= \iota x.\text{german}(x) \ \& \ c(x)$

where  $c$  is some way of contextually restricting  $x$ .<sup>51</sup>

Given that, we have a way of letting *the Germans* be understood as denoting the German students; let the contextual restrictor  $c$  be the property of being a student.<sup>52</sup> With this in place, we can understand why (220) can only mean that the German students were dancing in the quad. Consider the equivalence which QUD-GIVENNESS requires.

(223)    a.    Which students were dancing in the quad? — The Germans ~~were dancing in the quad.~~

---

<sup>50</sup>I am supposing that *german* here is a predicate that contains plural individuals as well as singular individuals in its extension, and that the iota operator  $\iota$  applied to a predicate  $P$  returns the maximal individual which satisfies  $P$  (and is undefined if there is no such individual). That is, ' $\iota x.\text{german}(x)$ ' should be read as denoting the plurality of all Germans.

<sup>51</sup>Here,  $c$  is shown as a property, i.e. a predicate of entities. There are issues with letting  $c$  contextually pick up a salient property, as discussed by Kratzer 2004; there are cases where it seems to overgenerate. Kratzer proposes an alternative analysis in which the contextual restriction is actually provided by a situation (i.e. partial world) variable provided to the NP: that is, [[the Germans]] =  $\iota x.\text{german}(x)(s)$ , where  $s$  is a contextually salient situation. I think that either restriction via contextually salient properties or via contextually salient situations would work for my purposes; I stick with the property-type analysis only for expository purposes.

<sup>52</sup>Or, in Kratzer's situation-based approach, pick a situation which contains all and only the students under consideration.

- b. QUD = [[Which students were dancing in the quad?]]  
= {Hans was dancing in the quad, Angela was dancing in the quad, Sam was dancing in the quad, ... }
- c.  $\bigcup$ QUD =  $\exists x \in \text{student}.x$  was dancing in the quad
- d. [[E]] = [[The Germans were dancing in the quad]]
- e. [[E]]<sup>F</sup> = ?

Given that the set of focus alternatives to [[E]] must contain [[E]], then the set in (223) must contain the proposition denoted by *The Germans were dancing in the quad*. But we also need the set of focus alternatives in (223e) to only contain propositions which talk about students, in order to ensure mutual entailment between  $\bigcup$ QUD and  $\bigcup$ [[E]]<sup>F</sup>. That is, we want something like the below:

- (224) [[E]]<sup>F</sup> = {the German students were dancing in the quad, student1 was dancing in the quad, student2 was dancing in the quad, student1+student2 were dancing in the quad, ... }

This means that the proposition expressed by the elided clause *The Germans ~~were dancing in the quad~~* has to be understood as meaning ‘the German students were dancing in the quad’. Domain restriction provides a way to do this, as shown in (222). That the other focus alternatives in the set are restricted to only range over students can be ensured by the contextual restriction on focus alternatives discussed at example (215).<sup>53</sup> We can then derive the equivalence that QUD-GIVENNESS demands, as shown below.

---

<sup>53</sup>Things start getting confusing here, as I am talking about two types of contextual restriction. One is the restriction on the domain of a quantifier like *the Germans* or *every student*. The other is the contextual restriction on what focus alternatives are projected. These are clearly related and may even be the same thing (cf. von Stechow 1994), but I will continue to talk about them here as if they were separate.

- (225) a. Which students were dancing in the quad? — The Germans ~~were dancing in the quad.~~
- b. QUD = [[Which students were dancing in the quad?]]  
= {Hans was dancing in the quad, Angela was dancing in the quad, Sam was dancing in the quad, ... }
- c.  $\bigcup \text{QUD} = \exists x \in \text{student}.x \text{ was dancing in the quad}$
- d.  $[[E]]^F = \{\text{the German students were dancing in the quad, student1 was dancing in the quad, student2 was dancing in the quad, student1+student2 were dancing in the quad, ... }\}$
- e.  $\bigcup [[E]]^F = \exists x \in \text{student}.x \text{ was dancing in the quad}$

Note that crucially here, in order for there to be mutual entailment between (225c) and (225e), the phrase *the Germans* has to be contextually restricted to meaning only the German students. That is why (226) can *only* mean that the German students were dancing; and it is why both examples in (227) (which parallels Jacobson's examples) is incoherent.

(226) Milling around in the quad are some American faculty, some American students, some German faculty, and some German students. The German students start dancing, although the German faculty refrain.

A: Which students were dancing in the quad?

B: The Germans.

(227) A: Which students were dancing in the quad?

a. B: #The Germans, but they're not students.

b. B: #The Germans, including the faculty.

By contrast, the full clausal answer does not need to meet such a stringent condition. As such, in the full clausal answer, the phrase *the Germans* can unproblematically refer to all the Germans, including faculty.



- (228) A: Which students were dancing in the quad?
- a. B: The Germans were dancing in the quad, but they're not students.
  - b. B: The Germans were dancing in the quad, including the faculty.

We therefore achieve the effect of ‘presupposition inheritance’ in short answers by ensuring that the choice of contextual domain restriction variable *C* is one which makes the ellipsis condition go through. This has the effect of only allowing answers where the denotation of definite DPs (like *the Germans*) are restricted to the domains specified in the question; that is, in answer to a question like *Which students were dancing in the quad?*, the answer *the Germans* is interpreted only as ranging over students, not over everyone who happened to be in the quad. Domain restriction is independently necessary, and in section 3.4 we have seen the advantages of making the ellipsis condition dependent on the Question under Discussion. Uniting these two ingredients has led to an account of the obligatory nature of ‘presupposition inheritance’ in clausal ellipsis; the requirement to be QUD-GIVEN forces a restriction in the domain of DP fragments used as short answers, while no such restriction is required in full clausal answers.

In the remainder of this section, I will consider two remaining issues. The first is the issue of *functional questions* (Engdahl 1986 and much subsequent work), which seem to pose a challenge to the QUD-GIVENNESS condition. The second is the issue of whether the Question under Discussion that the QUD-GIVENNESS condition makes reference to has to be the ‘immediate’ QUD; I argue that a flexibility will be needed here, and that the condition will in fact only need to refer to *some* member of the QUD *stack*, in the sense of Roberts 2012/1996. I first turn to the matter of functional questions.

### 3.4.5 Functional questions

Engdahl 1986 discusses *functional questions* like (229).

(229) Which paper should every professor remember?

(Every professor should remember) the paper that got him tenure.<sup>54</sup>

Here, the answer given to the question does not denote a specific entity, but rather has been taken to denote (the intension of) a function which maps professors into entities; here, the function which maps professors  $x$  into papers which got  $x$  tenure. The question in (229) can be given the denotation in (230), following e.g. Engdahl 1986, Heim 2012.

(230) [[Which paper should every professor remember?]]

$= \{p | \exists f.p = \lambda w.\forall x.\text{professor}(x)(w) \Rightarrow \Box\text{remember}(f(x))(x)(w)\}$

$\approx \{\text{every professor should remember the paper that got him tenure, every professor should remember his first paper, ...}\}^{55}$

We can take the union of the above question and get the below (neglecting intensionality):

(231)  $\bigcup$ [[Which paper should every professor remember?]]

$= \exists f.\forall x.\text{professor}(x) \Rightarrow \Box\text{remember}(f(x))(x)$

There now, however, appears to be a problem for our antecedence condition on ellipsis. Consider what happens in a short answer like (232), on an elliptical analysis.

(232) Which paper should every professor remember?

~~Every professor should remember~~ the paper that got him tenure.

---

<sup>54</sup>Assume, sadly contrary to actual academic practice, that one paper is sufficient to get tenure.

<sup>55</sup>The functions involved have to be ‘natural’, that is, one whose intension is ‘graspable’ in some way (see e.g. discussion in Chierchia 1992). Without this restriction, the condition is rather weak, as there will be a huge number of functions which map professors into entities. I neglect this issue here.

If we assume that *the paper that got him tenure* is in focus here, then there appears to be a problem. A DP like *the paper that got him tenure*, at least on its most obvious reading, denotes an entity, not a function. We would therefore expect the focus alternatives projected by this DP to range over entities, as below.

- (233) a.  $\llbracket \text{the paper that got him}_1 \text{ tenure} \rrbracket^g = \iota x.x$  is a paper that got  $g(1)$  tenure<sup>56</sup>  
 b.  $\llbracket \text{Every professor}_1 \text{ should remember } [\text{F the paper that got him}_1 \text{ tenure}] \rrbracket^F$   
 $\approx \{ \text{every professor}_1 \text{ should remember the paper that got } g(1) \text{ tenure, every professor}_1 \text{ should remember } \textit{Remarks on nominalization}, \text{ every professor}_1 \text{ should remember } \textit{The proper treatment of quantification in ordinary English}, \dots \}$ <sup>57</sup>

The union of (233b), which contains one member with a bound pronoun (which varies according to professors) and several others with entities, is a rather odd disjunctive proposition:

- (234)  $\bigcup \llbracket \text{Every professor}_1 \text{ should remember } [\text{F the paper that got him}_1 \text{ tenure}] \rrbracket^{g^F}$   
 $= \text{every professor}_1 \text{ should remember the paper that got } g(1) \text{ tenure}$   
 $\vee \exists x \in \text{paper. every professor}_1 \text{ should remember } x$

It is clear that (234) does not mutually entail (231). The non-unioned versions (233) and (230) are not identical either. So neither Reich 2007's original clausal ellipsis condition, nor my amended version involving set-union, predicts that short functional answers should be felicitous. Nevertheless, they are, as (232) shows.

How can we resolve this? One way would be to assume that DPs like *the paper that got him<sub>1</sub> tenure* can in fact denote functions, in this particular case the function from entities  $x$

---

<sup>56</sup>See e.g. Heim & Kratzer 1998 for the treatment of indexed pronouns as free variables in semantics which receive their denotation from the assignment function  $g$ .

<sup>57</sup>I am assuming here that the focus alternatives are contextually restricted to papers, as discussed in section 3.4.4.

to the paper that got  $x$  tenure. This proposal is made, for example, by Jacobson 1994 and Sharvit 1999, on the basis of sentences such as the below.

(235) The woman that every Englishman loves is his mother.

In sentences such as (235), the quantifier *every Englishman* does not c-command *his*, a pronoun which appears to be bound by it; and because it is inside a relative clause, *every Englishman* cannot scope out by QR to take scope over *his* either. Nevertheless, *his* can be interpreted in (235) as co-varying with *every Englishman*. The proposal Jacobson and Sharvit make is that both the DPs *the woman that every Englishman loves* and *his mother* can denote functions: the first, the function from Englishmen to women loved by Englishmen, and the second, the function from individuals to their mothers. A sentence like (235) expresses equality between these two functions.

I refer the reader to Jacobson 1994 and Sharvit 1999 for details of the compositional procedure which allows DPs like *the woman that every Englishman loves* and *his mother* to be interpreted as denoting functions. Their proposals for the interpretation of (235) rely on certain assumptions concerning the interpretation of pronouns and/or of binding which won't be adopted here. However, if these proposals were adopted, then the problem above would disappear: if a DP like *the paper that got him tenure* could denote a type  $\langle e, e \rangle$  function mapping individuals  $x$  to papers that got  $x$  tenure, then the focus value of such a DP would range over type  $\langle e, e \rangle$  functions, and there would be matching between the focus value of a sentence like *Every professor should remember the paper that got him tenure* and the functional reading of a question like *Which paper should every professor remember?*. A fortiori, there would be mutual entailment between the unions of the focus value of the answer and of the question.<sup>58</sup>

---

<sup>58</sup>That wouldn't be the end of the story; if *the paper that got him tenure* denoted a type  $\langle e, e \rangle$  function, then interpreting the verb phrase *remember the paper that got him tenure* would require that the verb *remember* be type-shifted so that it can combine with a type  $\langle e, e \rangle$  argument (rather than a type  $\langle e \rangle$  argument). Jacobson 1994 provides a rule of type-shifting (and binding) that does this; I won't review this in detail here.

I propose an alternative solution, one which relies on the ‘structural’ account of how focus alternatives are constructed proposed by Fox & Katzir 2011, which has already been invoked in section 3.4.2. Suppose that the focus alternatives projected by a phrase like *the paper that got him<sub>1</sub> tenure* are not simply all those alternatives which are of entity type, but rather are constructed in the object language syntax. If we adopt this view, then the alternatives themselves are allowed to contain pronouns. That is, the alternatives are the set below.

- (236)  $\llbracket \llbracket_{\text{F}} \text{the paper that got him}_1 \text{ tenure} \rrbracket \rrbracket^F =$   
 $\{ \llbracket \text{the paper that got him}_1 \text{ tenure} \rrbracket, \llbracket \text{the paper that got him}_1 \text{ fired} \rrbracket, \llbracket \text{the paper he}_1$   
 $\text{wrote first} \rrbracket, \llbracket \text{his}_1 \text{ best paper} \rrbracket, \llbracket \text{Remarks on nominalization} \rrbracket, \llbracket \text{The proper treat-}$   
 $\text{ment of quantification in ordinary English} \rrbracket, \dots \}$

We now rely on the fact that the value of any expression of the kind  $\iota y[\dots x \dots]$ , where  $x$  is a free variable, will vary with the value of  $x$ . That is, any such expression is a function of  $x$ , and can be rewritten as such:<sup>59</sup>

- (237) If  $x$  is a free variable, then there is some function  $f$  from entities to entities such that:  
 $\iota y[\dots x \dots] \equiv f(x)$

That is,  $\llbracket \text{the paper that got him}_1 \text{ tenure} \rrbracket^g$  can be rewritten as a function<sup>60</sup> of the value that the assignment function  $g$  gives to 1; for example, it can be written as  $a(g(1))$ , if  $a$  is that

---

<sup>59</sup>This is very similar to, although distinct from, the method of Skolemizing a quantified statement to remove existential quantification from it.

<sup>60</sup>A note to forestall confusion here: this is *not* saying that a definite description like *the paper that got  $x$  tenure* denotes a type  $\langle e, e \rangle$  function, in the way proposed by Jacobson and Sharvit. I remain agnostic on whether interpreting definite descriptions as type  $\langle e, e \rangle$  functions is generally possible or not, but here, I am treating the denotation of this definite description as type  $e$ . What this says is that the denotation of this definite description will vary as a function of  $x$ , and so we can rewrite the expression of predicate logic which translates *the paper that got  $x$  tenure* as an expression that contains a function whose argument is  $x$ .

function which maps individuals  $x$  to the paper that got  $x$  tenure.<sup>61</sup> We could therefore rewrite (236) in the following way, where  $a, b, c, d, \dots$  are names of type  $\langle e, e \rangle$  functions.

$$(238) \quad \llbracket [\text{F the paper that got him}_1 \text{ tenure}] \rrbracket^{g^F} = \{a(g(1)), b(g(1)), c(g(1)), d(g(1)), \dots, \\ \text{Remarks on nominalization, PTQ}, \dots \}$$

where  $a$  = a function mapping individuals  $x$  to papers that get  $x$  tenure

$b$  = a function mapping individuals  $x$  to papers that get  $x$  fired

$c$  = a function mapping individuals  $x$  to the paper that  $x$  wrote first

$d$  = a function mapping individuals  $x$  to  $x$ 's best paper

...

Composing this focus value with *Every professor should remember*, we get the below focus value:

$$(239) \quad \llbracket \text{Every professor}_1 \text{ should remember } [\text{F the paper that got him tenure}] \rrbracket^{g^F} = \\ \{ \text{every professor}_1 \text{ should remember } a(g(1)), \text{ every professor}_1 \text{ should remember } \\ b(g(1)), \text{ every professor}_1 \text{ should remember } c(g(1)), \text{ every professor}_1 \text{ should re-} \\ \text{member } d(g(1)), \dots, \text{ every professor}_1 \text{ should remember } \textit{Remarks on nominal-} \\ \textit{ization}, \text{ every professor}_1 \text{ should remember } \textit{PTQ}, \dots \}$$

Taking the union of this set results in the below disjunction of propositions.

$$(240) \quad \bigcup \llbracket \text{Every professor}_1 \text{ should remember } [\text{F the paper that got him tenure}] \rrbracket^{g^F} \\ = \exists f. \text{ every professor}_1 \text{ should remember } f(g(1)) \vee \exists x. \text{ every professor should} \\ \text{remember } x \\ \text{(where } x \text{ ranges over papers, and } f \text{ ranges over functions whose ranges are pa-} \\ \text{pers)}$$

However, we can rewrite (240) as (241), discarding the right disjunct.

---

<sup>61</sup>This will be a partial function, reflecting the fact that many individuals have not written such a paper.

- (241)  $\exists f$ . every professor<sub>1</sub> should remember  $f(g(1))$   
 (where  $f$ 's range only includes papers)

This is because the disjunctive statement ‘ $\exists x$ . every professor should remember  $x$ ’ (= every professor should remember *Remarks on nominalization* or every professor should remember *PTQ* or...) is subsumed by those cases of ‘ $\exists f$ . every professor<sub>1</sub> should remember  $f(g(1))$ ’ where  $f$  is a constant function whose output does not vary with its argument (for example, the function that maps every entity onto *Remarks on nominalization*). The right disjunct in (240), then, adds nothing that’s not already expressed by the left disjunct, and so the right disjunct can safely be done away with.

And (241) is just what we want for the QUD-GIVENNESS condition.

- (242)  $\llbracket$ Which paper should every professor remember? $\rrbracket^g =$   
 $\{p \mid \exists f.p = \text{every professor}_1 \text{ should remember } f(g(1))\}$   
 (where  $f$ 's range only includes papers)

- (243)  $\bigcup \llbracket$ Which paper should every professor remember? $\rrbracket^g =$   
 $\exists f$ . every professor<sub>1</sub> should remember  $f(g(1))$   
 (where  $f$ 's range only includes papers)

- (244) a. Which paper should every professor <sub>$x$</sub>  remember? — ~~Every professor <sub>$x$</sub>  should remember the paper that got him <sub>$x$</sub>  tenure.~~  
 b.  $\bigcup \text{QUD} = (243) = \exists f$ . every professor<sub>1</sub> should remember  $f(g(1))$   
 c.  $\bigcup \llbracket \text{E} \rrbracket^F = (241) = \exists f$ . every professor<sub>1</sub> should remember  $f(g(1))$

There is mutual entailment between (244b) and (244c), and therefore fragment answers to functional questions are predicted to be felicitous, as desired.

The story does not quite end here: the above procedure required the definite description in the fragment to contain a pronoun in it (in order to allow it to be rewritten as the result

of applying a function to that pronoun). However, some cases of functional answers do not seem to need such a pronoun:

- (245) A: To each boy, I assigned a (different) paper by Chomsky and a (different) paper by Montague. Which paper that I assigned did every boy find too hard?  
B: The paper by Montague.

Here, *the paper by Montague* should vary with the boys, i.e. should be a function of the variable quantified over by *every boy*. Unfortunately, there is no overt pronoun inside *the paper by Montague* which would allow us to rewrite this definite description as a function of the value given to that pronoun.

Fully understanding these cases will depend on understanding how the full clauses (*Every boy found the paper by Montague too hard*) also show the effect where the papers can co-vary with the boys despite there being no obvious way in which *every boy* can bind a variable inside the definite description (as there is no variable there); i.e. this is not an issue which is specific to the elliptical case. As such, I put these cases aside here.<sup>62</sup> However, it seems as if functional fragment answers present no roadblock to an analysis of clausal ellipsis in terms of QUD-GIVENness.

Having considered the issue of functional short answers, I now turn to another issue: the antecedence condition proposed here does not seem to merely target the *immediate* Question under Discussion. In the next section, I argue that the condition has to have the flexibility to target non-immediate QUDs.

---

<sup>62</sup>Such cases are obviously related to donkey-sentences and the correct analysis of definite descriptions/E-type pronouns (*Every farmer who owns a donkey beats it/the donkey*). This is far too big a topic to address here, but we could for example adopt the approach of Elbourne 2005, in which sentences like *every boy found the paper by Montague too hard* would invoke quantification over boy-situation pairs; the definite description *the paper by Montague* would contain a covert situation pronoun, and so could be evaluated with respect to each different boy-situation, allowing for papers to vary with boys. Whether this interacts in any significant way with the proposals I have put forward for clausal ellipsis is a topic I have to set aside here.



### 3.4.6 The QUD stack

Consider examples like the below.<sup>63</sup>

(246) Teacher: What's the capital of Australia? Canberra or Sydney?

Students: [silence]

Teacher: OK, well, who thinks Canberra?

(247) A: What's the capital of Israel?

B: There are various opinions on that.

A: OK, well, who thinks Jerusalem is the capital of Israel, and who thinks Tel Aviv is?

B: The US Senate thinks Jerusalem. The US State Department thinks Tel Aviv.

In (246), the ellipsis is ~~x is the capital of Australia~~. But the immediate QUD is not 'what is the capital of Australia?' but rather 'who thinks Canberra is the capital of Australia?', i.e. the immediate QUD is the one that the teacher is asking. We might suggest that the ellipsis condition makes reference to the QUD that was immediate before the elliptical utterance was made, but we will see in section 3.8 that we will not want to make this move: the QUD which the elliptical sentence brings into existence should also be one which the ellipsis condition itself can make reference to. In any case, even if we did make this move, the case in (247) would not be handled. In B's last reply, the elided clause is ~~x is the capital of Israel~~. But the immediate QUD is not 'what is the capital of Israel'. Rather, the immediate QUD is a rather complex, 'conjoined' question 'who thinks Jerusalem is the capital of Israel and who thinks Tel Aviv is the capital of Israel'. The source for the ellipsis is one of the foregoing questions, not the immediate one.

We might wonder at this point if we have discovered that the ellipsis condition does not make reference to the QUD at all: perhaps it simply tries to locate *any* preceding

---

<sup>63</sup>These examples show that fragments can be embedded under a verb like *think*. Chapter 5 contains detailed discussion of this phenomenon.

expression of question type in the discourse which it can be anaphoric to. The (immediate) QUD would be one such possibility, but so too would explicitly expressed questions (such as ‘What’s the capital of Israel?’ in (247) or ‘What’s the capital of Australia?’ in (246)). However, I think there is evidence to suggest that we really want the ellipsis condition to make reference only to the QUD, and not merely any antecedent which denotes a question. Evidence for this comes from examples which are similar to those discussed by AnderBois 2010; questions which are introduced in parentheticals cannot be antecedents for clausal ellipsis in fragment answers.

- (248) A: I wonder who wrote this nasty letter.
- a. B: Well I don’t know, but John thinks Bill did ~~write this nasty letter~~.
  - b. B: Well I don’t know, but John thinks Bill ~~wrote this nasty letter~~.
- (249) a. John, who is wondering who wrote this nasty letter, thinks Bill did ~~write this nasty letter~~.
- b. \*John, who is wondering who wrote this nasty letter, thinks Bill ~~wrote this nasty letter~~.

If a question is introduced explicitly as in (248), both verb phrase ellipsis and clausal ellipsis are possible, as (248a, b) show.<sup>64</sup> However, if the question is introduced in a parenthetical, as in (249), verb phrase ellipsis (249a) is possible – but clausal ellipsis (249b) is not. This would not be explicable on an analysis in which clausal ellipsis simply went looking for some question-denoting constituent to serve as antecedent. Rather, I think what the failure of examples like (249b) tells us is that parentheticals do not affect the QUD (in AnderBois 2010’s terms, they do not ‘raise issues’).<sup>65</sup> As such, clausal ellipsis cannot use questions

---

<sup>64</sup>For some speakers, (248b) might be somewhat marginal, because of the embedding of a fragment under *think*. Such cases of embedding are discussed in much more detail in chapter 5. However, I think the contrast between (248b) and (249b) is very clear.

<sup>65</sup>It’s not the case that parentheticals can never provide antecedents for anaphora in general. The verb phrase ellipsis cases show us this, as do examples like (i).

introduced in parentheticals as antecedent, but must rather only use questions which are part of the QUD.

We need to adjust the ellipsis condition to be able to look at non-immediate QUDs. For this I propose to use the technology of the Question under Discussion *stack*, as implemented by Roberts 2012/1996: ‘the ordered set of all as-yet unanswered but answerable, accepted questions’ (p. 15).<sup>66</sup> Informally (see Roberts 2012/1996 for the formal implementation), every time a question is asked, it is placed on top of a ‘stack’. As questions are resolved, they are removed from the top of the stack. So, for example, in the below discourse (adapted from Roberts 2012/1996’s ( $\mathcal{D}_0$ )), each question as it is raised goes on top of the stack, and it is the topmost question on the stack which must be resolved.

- (250) Who ate what?
- a. What did Hilary eat?
    - (i) Did Hilary eat bagels?
    - (ii) Did Hilary eat tofu?
  - b. What did Robin eat?
    - (i) Did Robin eat bagels?
    - (ii) Did Robin eat tofu?

The relation between a question which is licitly placed on top of the stack and the questions which are already on the stack is detailed by Roberts 2012/1996 (clearly there must be some relation: we cannot move from *Who ate what?* to, e.g., *What’s the capital of Australia?* without resolving the first question). For our purposes, we can rely on the notion that a

---

(i) John, who rode a camel once, gave it an apple.

Rather, the failure of parentheticals to support clausal ellipsis seems to be linked to its inability to raise a new QUD (modulo the discussion in Collins et al. 2014).

<sup>66</sup>Roberts uses the term QUD for this entire stack, using the term ‘immediate question under discussion’ for the question at the top of the stack. I will sometimes be lax with this terminology.

stack exists, and that an acceptable discourse move has to address the question at the top of this stack (not questions in the ‘middle’, for example).

Having the notion of a QUD stack, we can adjust our ellipsis condition so that it makes reference to any question which is on that stack, not merely the immediate question under discussion. This reformulation is presented in (251).

(251) QUD-GIVENness (*final version*)

A clause E is QUD-GIVEN iff there exists a question  $Q$  on the QUD stack such that  $\bigcup Q \Leftrightarrow \bigcup \llbracket E \rrbracket^F$ .

Here, a clause can be elided as long as the union of its focus value mutually entails the union of some unresolved question (not necessarily the immediate one). This allows us to handle cases like (252), repeated from (247).

(252) A: What’s the capital of Israel?

B: There are various opinions on that.

A: OK, well, who thinks Jerusalem is the capital of Israel, and who thinks Tel Aviv is?

B: The US Senate thinks Jerusalem. The US State Department thinks Tel Aviv.

The QUD stack here (where rightmost position in the tuple indicates being on top of the stack) is ⟨‘what’s the capital of Israel’, ‘who thinks Jerusalem is the capital of Israel and who thinks Tel Aviv is’⟩.<sup>67</sup> The ellipsis in B’s second utterance is ~~is the capital of Israel~~. This isn’t provided by the immediate question under discussion, but there is an unresolved question on the stack which does provide it. As such, the ellipsis condition in (251) goes through: there is a  $Q$  on the QUD-stack such that  $\bigcup Q$  (i.e.  $\exists x.x$  is the capital of Israel)  $\Leftrightarrow \bigcup \llbracket E \rrbracket^F$  (i.e.  $\exists x.x$  is the capital of Israel).

---

<sup>67</sup>I will not try here to disentangle the second question into any component parts it may have.

Note that independent considerations on discourse require that the topmost question(s) on the stack be the ones that are actually *addressed* by a discourse move, and indeed the answer B gives in (252) answers the immediate QUD, although the ellipsis is anaphoric to a question lower on the QUD stack. B cannot answer the non-immediate question under discussion.

(253) A: What's the capital of Israel?

B: There are various opinions on that.

A: OK, well, who thinks Jerusalem is the capital of Israel, and who thinks Tel Aviv is?

B: #Tel Aviv.

B': #Tel Aviv is the capital of Israel.

The response B gives in (253) is infelicitous, but this is nothing to do with ellipsis; it is infelicitous because it doesn't address the immediate QUD. Note that the full clausal answer, given as B', is also infelicitous.

### 3.4.7 Interim summary

In this section, I have argued for a QUD-based condition on clausal ellipsis, QUD-GIVENNESS, which is very similar to the condition proposed by Reich 2007, but which 'imports' the benefit of existential quantification which Merchant 2001, 2004's e-GIVENNESS has. I have argued that such a condition correctly predicts sensitivity to the QUD, as well as explaining the goodness of 'mismatch' answers. In the remainder of this chapter, I will discuss some other predictions made by a QUD-GIVENNESS account, and to what extent the clausal ellipsis condition will have to make reference to the syntactic properties of an antecedent. I will also explore what the ramifications of such an account are for antecedentless fragments, and for sluicing. I first turn to some additional support for a QUD-based theory of clausal ellipsis drawn from the pragmatics of discourse.

### 3.5 Manipulating the QUD

I have argued that the clausal ellipsis condition should be fundamentally based on the Question under Discussion. Such a condition suggests that clausal ellipsis should be sensitive to manipulations of the Question under Discussion by interlocutors. In this section I aim to show that this is a welcome prediction.

One argument I have made above for a QUD-based condition on clausal ellipsis is that short/fragment answers must ‘directly’ answer the question that is posed. That is, while the full answer in (254a) is acceptable, the short answer in (254b) is unacceptable.

(254) (repeated from (125))

Which Brontë sister wrote ‘Emma’?

- a. JANE AUSTEN wrote ‘Emma’, you fool.
- b. #JANE AUSTEN, you fool.

I have argued that the reason (254b) is infelicitous is because the QUD-GIVENNESS condition requires that the focus closure of the elided clause here should mutually entail the union of the QUD. In this case, it does not, as shown in (255) below. The focus value of the elided clause must contain the proposition ‘Jane Austen wrote Emma’, but this proposition will not be a member of the QUD. As such, QUD-GIVENNESS will not be satisfied.

(255) Which Brontë sister wrote ‘Emma’? — Jane Austen ~~wrote Emma~~.

- a.  $\text{QUD} = \{\text{Charlotte wrote ‘Emma’}, \text{Emily wrote ‘Emma’}, \text{Anne wrote ‘Emma’}\}$
- b.  $\bigcup \text{QUD} = \exists x \in \text{bronteSister}.x \text{ wrote Emma}$
- c.  $[[E]]^F = \{\text{Jane Austen wrote ‘Emma’}, \text{Charlotte Brontë wrote ‘Emma’}, \dots\}$

However, the failure of QUD-GIVENNESS to go through here is predicated on the fact that the Question under Discussion contains a restriction to Brontë sisters. But Questions under Discussion can rapidly change as a dialogue evolves. Does the ability to elide a clause track

this change? I argue that it does. Firstly, clearly an explicit change in the QUD can license a fragment answer, which is not surprising.

- (256) A: Which Brontë sister wrote 'Emma'?
- B: No Brontë sister wrote 'Emma', you idiot.
- A: Oh! Well who did, then?
- B: Jane Austen.

But now note also the improvement of a short answer in cases like the below.

- (257) A: Which Brontë sister wrote 'Emma'?
- B: No Brontë sister wrote 'Emma', you idiot.
- A: Oh! Um, well... [raises eyebrows hopefully]
- B: [sighs] Jane Austen.

Here, I argue that A's response to B has the function of implicitly changing the QUD, removing the restriction to only Brontë sisters (which B has told A is an inaccurate presupposition), and changing the QUD to be something like *Who wrote 'Emma'?*. The following dialogue (suggested to me by Lyn Frazier), in which a third speaker is involved, is also reported to improve the acceptability of the short answer.

- (258) [Context: A and B are talking, C is minding her own business in the corner.]
- A: Which Brontë sister wrote 'Emma'?
- B: No Brontë sister wrote 'Emma', you idiot.
- C: Jane Austen.

The judgments here are quite delicate. For example, one might expect (259) to be good, but to my ear it seems quite degraded, although I have collected some varying judgments on this point.

(259) A: Which Brontë sister wrote ‘Emma’?

B: No Brontë sister wrote ‘Emma’, you idiot – Jane Austen.

One might expect that the response *No Brontë sister wrote ‘Emma’*, which completely answers the immediate QUD, might instantly ‘change’ the QUD to *Who wrote ‘Emma’*; but this does not quite seem to happen, and rather some sort of ‘extra business’, as with A’s responses and eyebrow-raising in (257), seems to be necessary. I argue, however, that these cases of delicate judgments and inter-speaker variation support the case that the clausal ellipsis condition is based on the Question under Discussion. If the Question under Discussion is a fundamentally pragmatic notion, constructed in discourse rather than being part of the ‘grammar’ per se, then we might expect that speakers’ reactions to cases like (257), (258), (259) would differ depending on, for example, the ease with which they ‘accommodate’ changes in the discourse.<sup>68</sup>

I will not try to give a deep theory of the relevant pragmatic factors that might contribute to this here, as that would be well beyond the scope of this dissertation. However I will note one possible parallel which has been drawn to my attention. Barbara Partee has suggested to me that cases like (259) might be analogous to the famous contrast in (260), cited in Heim 1982 and originally due to Partee:

- (260) a. I dropped ten marbles and found all of them, except for one. It is probably under the sofa.
- b. I dropped ten marbles and only found nine of them. ?It is probably under the sofa.

The referent for *it* in (260b) ‘should’ be obvious – the missing marble – and yet there is difficulty in understanding *it* as referring to that object. If there isn’t a directly introduced linguistic referent for the pronoun to refer to, as there is in (260a), it seems that the gram-

---

<sup>68</sup>This might account for the small population of English speakers I have encountered who in fact accept exchanges like *Which Brontë sister wrote ‘Emma’? — Jane Austen, you fool.*



mar just won't let us use pragmatics 'right away' to establish what the salient referent is. However, as with the short answer cases, manipulating the context can improve matters:

(261) Mom: What's wrong?

Child: I dropped ten of my marbles, but I've only been able to find nine of them.

Can you help me look?

Mom: OK, let me see if I can help you find it.

Here, I feel that *it*, although it still doesn't have a linguistic referent, can rather more easily be understood as referring to the missing marble. Short answers seem to behave similarly to pronouns without explicit antecedents; just like such pronouns, short answers also apparently cannot be used 'right away', even if the nature of the changed QUD 'should' be obvious, without a certain amount of signaling (perhaps fairly implicit, as in (257)) that the discourse's QUD has changed.

While the methods discussed above of manipulating the QUD seem to be fairly variable and unreliable, there are however certain other methods of manipulating a QUD short of simply asking an explicit question. These methods are fully linguistic (that is, they don't rely on any extra-linguistic means like raising eyebrows or the like) and also reliably change the QUD (that is, the judgments are generally reported as sound). One such method is to use contrastive topic marking, realized as a rise-fall-rise contour (or B-accent, Jackendoff 1972).<sup>69</sup> Contrastive topic marking can be *in situ* as in (262a); or it can co-occur with fronting as in (262b); or the contrastive topic can be introduced by an 'as for' adjunct and resumed by a pronoun, as in (262c). (I mark contrastive topic/rise-fall-rise contour/B-accent with <sub>CT</sub> and focus marking/pitch accent/A-accent with <sub>F</sub>.)

(262) To whom did he give the books? — Well, I don't know about the books, but...

a. ...he gave [<sub>CT</sub> the flowers] [<sub>F</sub> to Mary].

---

<sup>69</sup>For further discussion of contrastive topics and their relation to the Question under Discussion, see e.g. Roberts 2012/1996, Büring 2003.

- b. ... [CT the flowers], he gave t [F to Mary].
- c. ... as for [CT the flowers], he gave [CT them] [F to Mary].

In all of these cases the contrastive topic accent has the same effect. The initial question is *To whom did he give the books?*. The responder signals that she doesn't know the answer to that question. However, she is in a position to (partially) answer a different question, namely *what did he give to whom?*. The question *what did he give to whom* is a 'superquestion' of *to whom did he give the books*, in Roberts 2012/1996's terms.<sup>70</sup> Contrastive topics, then, have the ability to 'shift' the QUD 'upwards' to a superquestion.<sup>71</sup> Given this, the obvious question for our purposes is to ask if using contrastive topics allows for a change in which clauses can be elided. The answer is that it does.<sup>72</sup> Consider the below dialogues.

(263) What kind of beer does John like to drink?

- a. He likes to drink cabernet sauvignon. He doesn't like beer.
- b. #Cabernet sauvignon. He doesn't like beer.

(264) What kind of beer does John like to drink?

- a. I don't know about beer, but as for [CT wine], he likes to drink cabernet sauvignon.
- b. I don't know about beer, but as for [CT wine], cabernet sauvignon.

In (263), the full clausal answer in (a) allows for the 'correction' of the presupposition that John has a particular kind of beer that he likes, but the fragment answer in (b) does not allow this possibility. This is another instance of 'presupposition inheritance' and is

---

<sup>70</sup>A question *Q* is a superquestion of *Q'* iff a complete answer to *Q* also provides a complete answer to *Q'*. In this case, completely answering *What did he give to whom?* would provide an answer to *To whom did he give the books?*.

<sup>71</sup>For details of how specifically this is done, see e.g. Roberts 2012/1996, Büring 2003, Constant 2012a. I will not presuppose any specific implementation here, relying just on the fact that contrastive topics do seem to have this ability to manipulate the QUD.

<sup>72</sup>See also Servidio 2013 for a similar proposal concerning fragment answers in Spanish.

consistent with the QUD-based theory of clausal ellipsis; the question is about beer, so an answer containing ellipsis should also be about beer.<sup>73</sup> Full answers do not have this requirement.

However, if the answer contains a contrastive topic, as in (264), the fragment answer in (b) is much more felicitous. I argue that this is because the use of the contrastive topic is a means of explicitly changing the Question under Discussion. As such, the QUD-based account should predict that clausal ellipsis should now be available, and indeed it is.

We can examine other explicit means of changing the Question under Discussion, and see that they also have the same effect on the felicity of short answers:

- (265) What kind of beer do you like?
- a. #Cabernet sauvignon.
  - b. I'd rather talk about wine. Cabernet sauvignon.
  - c. You know I don't like beer. If you actually meant to ask me about wine, then cabernet sauvignon.
  - d. Pilsner; and as for wine, cabernet sauvignon.

We can see that the QUD-based theory of clausal ellipsis captures the fact that if the QUD is explicitly changed, by means of contrastive topic marking for example, then the possibilities for clausal ellipsis also change. This adds to the support for the QUD-GIVENNESS condition proposed here. Further support for a QUD-based theory of clausal ellipsis comes from the availability of antecedentless fragments, which I now discuss.

---

<sup>73</sup>It might be noted that (i) is somewhat better, although still degraded.

- (i) What kind of beer does John like to drink?  
He doesn't like beer. ??Cabernet sauvignon.

To the extent that (i) is an improvement over (263b), we can understand this in pragmatic/discourse terms: putting *he doesn't like beer* first allows for a 'change' in the QUD, which is not signaled by (263b). This contrast can be seen as further evidence for a QUD-based condition for clausal ellipsis.

### 3.6 Antecedentless fragments

As discussed in section 2.4.4, fragments can be uttered without any explicit antecedent. I repeat some exemplar cases below, firstly from Robert Stainton's work (repeated from (33)), and secondly from Merchant 2004 (repeated from (34)).

- (266) a. [On getting into a taxi.]  
(To) the train station, please.
- b. [A & B are at a linguistics workshop. There is an empty chair. A nods at it and raises his eyebrows at B. B says:]  
An editor of *Natural Language Semantics*.
- c. [A child spooning out jam at the breakfast table.] Chunks of strawberries.
- d. [The child in (c)'s mother replying.] Rob's mom.
- e. [On hearing a strange sound.] The *nyo-gyin*, the song of mourning.
- f. [Admonishment to a child holding a bowl of soup insecurely.] Both hands!
- (267) a. Abby and Ben are at a party. Abby sees an unfamiliar man with Beth, a mutual friend of theirs, and turns to Ben with a puzzled look on her face.  
Ben says:  
"Some guy she met at the park."
- b. Abby and Ben are arguing about the origins of products in a new store on their block, with Ben maintaining that the store carries only German products. To settle their debate, they walk into the store together. Ben picks up a lamp at random, upends it, examines the label (which reads *Lampenwelt GmbH, Stuttgart*), holds the lamp out towards Abby, and proudly proclaims to her:  
"From Germany! See, I told you!"

These are the kinds of example which motivate Stainton’s treatment of these cases as non-elliptical, and rather being ‘independent’ fragments which receive a propositional interpretation via combining with a Mentalese property, rather than elided linguistic material.

### 3.6.1 ‘Restricted ellipsis’ under e-GIVENness

Merchant 2004 is aware of the problem, and attempts to deal with it by suggesting that for an expression to be e-GIVEN, it is not required that there be a linguistic antecedent. (p. 724: ‘The linguistic form of the deleted material need not be present in the discourse: an entity or action brought to perceptual salience is enough.’) Merchant argues that, in almost all cases, phrases like *x do it*, *it/that is x*, *there is x*, and the like, will be e-GIVEN in this sense; they refer to such general concepts of action, existence, deictic reference, and the like that the salience of almost any entity or action will license the entailment relation that e-GIVENness requires. Given this, any ellipsis site can contain very ‘general’ phrases such as *x do it* or *that is x*. That is, cases like (268) are analyzed as the ellipses shown. (As (268c) shows, Merchant intends this to be an explanation for so-called exophoric (antecedentless) VP ellipsis (Hankamer & Sag 1976, Schachter 1977, Pullum 2000, Miller & Pullum 2013), as well as fragment cases.)

- (268) a. (i) From Germany!  
(ii) ~~It is~~ from Germany!
- b. (i) Some guy she met at the party.  
(ii) ~~That is~~ some guy she met at the party.
- c. (i) [John is about to hack his own hand off with a meat cleaver.]  
Mary: Don’t!  
(ii) Don’t ~~do it~~!

More recently, van Craenenbroeck 2013a has made a similar proposal, arguing that ellipsis sites can include lexical material which is not present in the antecedent but which is ‘generally available’ to speakers (e.g. pronouns like *it*, *that*, the copula, the verb *do*, etc.).

I believe there are a number of problems with this line of argument, however. The first problem is that there are some cases in which clauses with an extremely ‘general’ meaning of existence, action, or deictic reference (*it is x, x do it, there is x* etc.) don’t look like they have the right meanings.

(269) [On getting into a taxi.]

To the train station, please.

a. Take me to the train station, please.

b. ??It’s to the train station, please.

c. #Do it to the train station, please.

In (269), the only appropriate elided clause seems to be something like *take me to x*. Merchant suggests that contexts like this might make salient a ‘script’ (in the sense of Schank & Abelson 1977) which provides the antecedent. A rough way of framing the intuition is that everyone knows how dialogues in taxis are meant to go. People know, for example, that on getting into a taxi, one says something like *Take me to the train station*. It is in ‘scripts’ of this sort – which are presumably linguistically represented in memory<sup>74</sup> – that the antecedent for the elided clause *take me to x* is made available. Cases like (270) are treated similarly.

(270) (originally from Stanley 2000)

A thirsty man approaches a vendor on the street and utters: Water.

---

<sup>74</sup>Merchant suggests that the scripts ‘make salient’ certain linguistic representations, but does not state whether he understands the scripts themselves to be linguistic objects, or are rather something more like our conception of the ‘normal course of events’. It seems to me that on Merchant’s view, the elided clause would genuinely have to look for a *syntactic* antecedent in this script (because syntactic phrase markers are the only things that can be e-GIVEN; see below). I would note that my intuition is that, to the extent that I have a ‘script’ in my head for getting into a taxi, it itself *contains clausal ellipsis* (i.e. the script looks something like *Where to? – The X, please*), which would be question-begging here.

Here, Merchant argues, the ‘script’ in a speaker’s head for what happens between a customer and a vendor provides the relevant elided clause: *give me x*. Other utterances such as *coffee, please* to a waiter are treated similarly.

However, there are parallel cases of fragments which do not plausibly have this sort of ‘script’.

(271) [Richard III on the battlefield.]

A horse! A horse!

- a. I want/need a horse!
- b. Give me a horse!
- c. #It’s a horse!
- d. #Do it to a horse!

(272) My kingdom for a horse!

- a. I will exchange my kingdom for a horse!
- b. #It’s my kingdom for a horse!
- c. \*Do it (to) my kingdom for a horse!

Every English speaker, on hearing this segment of *Richard III*, understands the meanings of the fragments in (271), (272). But we surely do not have a mental script, constructed from our day-to-day experiences and represented linguistically in memory, concerning what horseless kings are likely to say on battlefields. To say that a situation like Richard III’s in (271), (272) is scripted<sup>75</sup> would be to make the notion of ‘script’ a very weak one. It seems as if no ‘script’ can provide *I want x*, *give me x*, or *I will exchange X* here. But these sentences are also (presumably) not e-GIVEN in the same way as *it is* or *do it* are argued to

---

<sup>75</sup>Apart, of course, from the literal sense in which Shakespeare scripted these lines. The point is that even if a hearer is unfamiliar with that script, they still understand the propositional content of the fragments in (271), (272) on first hearing them.

be; ‘wanting’, ‘giving’, ‘exchanging’ are much more specific notions than simply ‘action’, ‘existence’, etc.

So not all fragments seem to be amenable to the ‘limited ellipsis’ strategy which Merchant suggests. There is also a more fundamental problem with the application of e-GIVENness to antecedentless ellipsis. Merchant argues that an elided clause can be e-GIVEN by dint of standing in a relation with a particular *semantic* object (the salient actions or entities referred to above), rather than standing in a relation with a linguistic antecedent. That conclusion does seem to be required by the existence of antecedentless fragments, if an elliptical analysis based on e-GIVENness is maintained. But this does not seem to me to be an accurate conclusion, given the below definition of e-GIVENness.

(273) An expression E is e-GIVEN iff there is an antecedent A such that  $F\text{-clo}(A) \Leftrightarrow F\text{-clo}(E)$ .

The question here is whether A has to be overtly linguistic in form, or if, rather, some semantic object – perhaps made salient by the context, but not linguistically overt – can be the antecedent A in the definition in (273). The answer is that, given the above definition, A must be an overt linguistic object, and more specifically a syntactic object. The operation of focus-closure (F-clo) is one that takes an object containing focus marks and returns a semantic expression with all the focus-marked constituents replaced with variables and existentially closed. But only syntactic phrase markers are the type of thing that can contain focus marks. Semantic objects such as propositions – sets of possible worlds – do not. As such, semantic model-theoretic objects cannot undergo focus closure; the operation of focus closure is simply not defined over such objects.<sup>76</sup>

---

<sup>76</sup>One could attempt to define an operation which could take both syntactic objects containing focus marks, and semantic objects like propositions, as input. But this would be a strange operation; I am not aware of any operation having been proposed in the literature which is defined over such different types of objects as both syntactic phrase markers and propositions.



The conclusion is that, while e-GIVENness is not a ‘syntactic’ condition on ellipsis as that phrase is normally understood in the ellipsis literature – i.e. it does not enforce a requirement of ‘isomorphism’ between two phrase markers, or make reference to their geometric or lexical properties in any way – it is nevertheless fundamentally dependent on syntax, in as much as a phrase can only be e-GIVEN by virtue of a relation with an antecedent syntactic object.

There are two ways of reconciling this fact about e-GIVENness with the availability of antecedentless ellipses. One possible route would be to say that in fact syntactic antecedents *are* made available, even if unspoken. One could perhaps imagine the ‘scripts’ as playing this role; and Merchant 2004:724 suggests that one could imagine that certain salient entities or actions might prompt LFs (that is, syntactic structures) describing those events or actions to arise in the mind of a speaker. It is those LFs (presumably along with focus marking) which could be the antecedent in the e-GIVENness relation.

Merchant says, however, that he isn’t prepared to defend the assumption that LFs can arise in speakers’ minds in such a way. I am not prepared to defend it either, not because I necessarily believe it not to be true, but because it is beyond the scope of this dissertation to investigate and defend it. I propose instead to take an alternative path: change the definition of e-GIVENness so that the antecedent need not be a syntactic object. This is what QUD-GIVENness does. In QUD-GIVENness, the antecedent is the union of the Question under Discussion. This is an object which is entirely constructed at the level of discourse; syntax is not involved at any point. As such, it is in principle equipped to deal with antecedentless cases of ellipsis; no linguistic antecedent is required.

We have already seen that an approach based on the Question under Discussion has independent support – for example, it explains why certain embedded clauses apparently cannot be antecedents for clausal ellipsis, as we saw in section 3.4. As such, I believe that changing the definition of the ellipsis condition such that the relevant antecedent is a purely semantic object ( $\cup$ QUD) is preferable to making the claim that LFs can be prompted to

arise in the minds of speakers, and these LFs are the relevant antecedent for the ellipsis condition. As stated above, I do not necessarily believe the latter to be an impossible conclusion. Rather, I argue that on grounds of parsimony, it is preferable to base the ellipsis condition entirely on the Question under Discussion in the first place, ‘bypassing’ the question of whether antecedent LFs can arise in the minds of speakers on the basis only of salient entities or events.

### 3.6.2 Antecedentless fragments and implicit QUDs

Having established an antecedence condition which is based on the Question under Discussion, a discourse object rather than a semantic one, we can see if it is equipped to handle antecedentless fragments. I argue that it is, as long as we allow the Question under Discussion in a given scenario to be implicit, and accommodated by a hearer on the basis of context, as suggested by Stanley 2000. The ‘taxi driver’ case is an obvious starting point. The Question under Discussion when one gets into a taxi, even if no-one has said anything, is unlikely to be anything other than *Where should the taxi go?* Given this QUD, the fragment answer in (274) can be understood as eliding a clause which corresponds to a phrase which is QUD-GIVEN. The only candidate for such a phrase is *the taxi should go to x*, and that is how the elided clause is understood.

(274) ~~The taxi should go~~ to [<sub>F</sub> the train station], please.<sup>77</sup>

- a. QUD (implicit) = Where should the taxi go?  
= {the taxi should go to the train station, the taxi should go to the city hall,  
the taxi should go to the airport... }
- b.  $\bigcup \text{QUD} = \exists x. \text{ the taxi should go to } x$
- c.  $\bigcup [\text{E}]^F = \exists x. \text{ the taxi should go to } x$
- d.  $\bigcup \text{QUD} \Leftrightarrow \bigcup [\text{E}]^F$ , therefore ellipsis is licensed.

---

<sup>77</sup>I assume that *to* here is pronounced, not because it itself is F-marked, but because a process of movement pied-pipes it to a position outside the ellipsis site; this will be discussed in more detail in section 4.4.

On this analysis, there is syntax in these antecedentless fragments; it just doesn't have any syntactic antecedent. Recall that we have positive evidence for the presence of structure in these antecedentless fragments, in the form of Case-matching effects; even in antecedentless fragments, remnants appear showing the morphological case that they would bear if they were in full structures, as shown below (repeated from (92), (93), (94) respectively).

- (275) a. (Enan) kafe (parakalo)!  
 a coffee.ACC please  
 '(A) coffee (please)!' (in a Greek café)
- b. Vody (pozhalujsta)!  
 water.GEN please  
 'Water (please)!' (in a Russian café)
- c. Dvumja rukami!  
 two.INSTR hands.INSTR  
 'Both hands!' (warning a Russian child to be careful with their bowl of soup)
- (276) a. Ferte mou (enan) kafe (parakalo)!  
 bring.IMP me a coffee.ACC please  
 'Bring me (a) coffee (please)!'
- b. Dajte mne vody (pozhalujsta)!  
 give.IMP me water.GEN please  
 'Give me (some) water (please)!'
- c. Pol'zujsjja dvumja rukami!  
 use two.INSTR hands.INSTR  
 'Use both hands!'
- (277) a. \*Kafes (parakalo)!  
 coffee.NOM please
- b. \*Voda (pozhalujsta)!  
 water.NOM please



there are only a small number of issues which Richard III could possibly be addressing. In the context (a de-horsed, about-to-be-attacked, king on a battlefield), the most likely Question under Discussion with the answer ‘a horse’ is the question of what King Richard desires. That is, the QUD is *What does King Richard want?* On the basis of this QUD, we infer that the structure of the ellipsis site is likely to be something like *I want x* (given that ‘I’ denotes King Richard here).

I believe the same proposal can explain other cases which are similarly script-less but which plausibly contain an implicit Question under Discussion, such as the chair example:

(279) [A & B are at a linguistics workshop. There is an empty chair. A nods at it and raises his eyebrows at B. B says:]

An editor of Natural Language Semantics.

Here, again, there is unlikely to be a ‘script’ involved. Rather, A’s act of nodding and raising his eyebrows makes salient an implicit Question under Discussion ‘Who is that chair for?’. It is that question that B answers, and a clause which is QUD-GIVEN on the basis of that QUD which is elided: ~~that chair is for~~ *an editor of Natural Language Semantics*. Stanley 2000 makes a similar proposal. Support for this position comes from an observation by Jeremy Hartman (p.c.): in the situation in (279), B can also ‘answer’ the question with a full clause, and with answers which look like they contain elements which must be anaphoric to the question, such as the null complement anaphora cases in (280b, c). This suggests that there is indeed a question being raised in such cases, and moreover, one which the grammar can refer to.<sup>78</sup>

---

<sup>78</sup>An obvious question is whether the null complement anaphora cases in (280b, c) are themselves cases of clausal ellipsis, perhaps cases with no focused material (i.e. the entire clause elides). The answer seems to be no; see section 5.13 for discussion.

- (280) [A & B are at a linguistics workshop. There is an empty chair. A nods at it and raises his eyebrows at B. B says:]
- a. It's for an editor of *Natural Language Semantics*.
  - b. I don't know. (= I don't know who that chair is for.)
  - c. You'll have to ask the session organizer. (= You'll have to ask the session organizer who that chair is for.)

### 3.6.4 Fragments used as imperatives

In some cases, it seems strange to talk about there being any sort of 'question' under discussion, at least intuitively. For example, the admonishment to a child holding a bowl of soup insecurely:

(281) Both hands!

Here, it's not clear that there's any sort of implicit question, or that *both hands* is an answer to something. In fact the fragment doesn't seem to be an assertion, as an answer would have to be. Rather this just seems to be a straight-up command in response to a dangerous situation: *Use both hands!*

If this was correct, we would be faced with two questions. The first is: is there in fact a Question under Discussion in cases like (281), and can we accommodate it in the fashion described above, on the basis of a fragment like (281)? The second question is: can QUD-GIVENNESS be defined in such a way as to license the ellipsis of an imperative clause? Do imperative clauses have the kind of propositional meaning which can be the input to QUD-GIVENNESS?

I will address the second question first. There could be a problem if we imagined that imperatives were, for example, speaker-directed properties of type  $\langle e, t \rangle$  (as in the analysis of Portner 2004). Such properties would not be the correct sort of semantic object to enter into a QUD-GIVENNESS relationship, and so the ability to elide imperative clauses would

be unexpected. However, on other analyses of imperatives, particularly that of Schwager 2005 (later published as Kaufmann 2012), imperative clauses do indeed have the same semantics as (modalized) declaratives do (e.g. *use both hands* has propositional content, the same propositional content as *you must/should use both hands*). If the latter kind of theory is correct, we could imagine that it is that propositional content which QUD-GIVENNESS makes reference to, and we could cash out the ability to elide imperative clauses by letting QUD-GIVENNESS refer to that propositional content.

In fact, I believe that a stronger claim can be made. I want to argue, perhaps somewhat counterintuitively, that in fact fragments like (281) are declarative even in their *form*. That is, the syntax of a fragment like (281) is as in (282a), not (282b).

- (282) Both hands!
- a. ~~You should use~~ both hands!
  - b. ~~Use~~ both hands!

It is clear that construing a modalized declarative clause in an ellipsis site is at least possible if the antecedent is an imperative, as the below example (adapted from Thoms 2013) shows.

- (283) A: Amuse me!  
B: With what?
- a. With what ~~should I amuse you~~?
  - b. \*With what ~~amuse you~~?

I will present evidence that in antecedentless cases such as (282), the structure of what is elided is not that of an imperative clause, but rather that of a declarative clause. The propositional meaning of that declarative clause (*You should use both hands* in (282)) can serve as the input to QUD-GIVENNESS.

Firstly, note that imperative clauses can be used in construction with certain sentence-final tags, as shown below.

(284) Use both hands, can't you/won't you/will you/could you?

But these tags are rather degraded if a fragment is used.

(285) Both hands, ??can't you/??won't you/??will you/??could you?

This is *prima facie* evidence against a fragment like *Both hands* containing an underlying imperative structure. This might not be a knock-down argument, however, in light of the fact that the distribution of sentence-final tags with fragments in general seems unclear. For example, as pointed out by van Craenenbroeck 2013b, there is a curious asymmetry between the tags which are grammatical in full clausal answers and those which are grammatical in fragment answers.

(286) Who wrote *Barriers*?

- a. Chomsky wrote *Barriers*, {didn't he/\*wasn't it?}
- b. Chomsky, {??didn't he/wasn't it?}

The reason for this is not clear, but whatever is behind the degradation of *didn't he* in (286b) might also explain the degradation of the tags in (285). So this may not constitute a clear argument against the presence of imperative clausal syntax in fragments like (285).

However, further evidence that elided fragments contain declarative clausal syntax comes from so-called 'Imperative and Declarative' structures (Culicover & Jackendoff 1997, Schwager 2005 and references therein). These are conjunction structures in which the left conjunct is imperative in form, but interpreted as the antecedent of a conditional, to which the right conjunct (declarative in form) is the consequent.

(287) (from von Fintel 2012)

- a. Study hard and you will pass the class.  
≈ If you study hard, then you will pass the class.



- b. Goof off and you will fail the class.  
     ≈ If you goof off, then you will fail the class.
- c. Invest in that company and you will become rich.  
     ≈ If you invest in that company, then you will become rich.

Now note the contrasts below (all being uttered in a context where a child is carrying soup unsafely).

- (288) a. Use both hands and I'll give you candy.
- b. ??Both hands and I'll give you candy.
- c. ??You should use both hands and I'll give you candy.  
         (# on relevant 'if-then' reading; only reading: I tell you that you should use both hands, and (whether you use both hands or not) I tell you that I will give you candy)
- (289) a. Use both hands and I won't get mad.
- b. ??Both hands and I won't get mad.
- c. ??You should use both hands and I won't get mad.  
         (# on relevant 'if-then' reading; only reading: I tell you that you should use both hands, and (whether you use both hands or not) I tell you that I won't get mad)

We can see that the felicity of the fragment conjoined with a declarative tracks the felicity of conjoining two declaratives. However, having a fragment as a left conjunct does not track the felicity of the IaD constructions, suggesting that what is being elided in cases like *Both hands!* does not have the structure of an imperative, but rather the structure of a declarative.

Note that it's not simply the case that fragments cannot be conjoined with full clauses in general. (289b) shows this, as does the following example (adapted from examples in Temmerman 2013b):

- (290) Who will win the Democratic primaries?  
Clinton, and the Republicans won't like that.

I take these two facts – the ungrammaticality of certain tags (which are grammatical with imperatives) in construction with fragments, and the inability of fragments to occur as the left conjuncts in Imperative and Declarative conditional constructions – as evidence for the generalization that, while fragments might sometimes have the illocutionary force of imperatives, the elided clauses they contain never have the *syntactic structure* of imperatives. They cannot occur in all of the environments in which true imperatives can.

It should be noted at this point that there are apparent counterexamples to the generalization that fragments cannot occur in constructions which look like IaD constructions. Cases like (291a) (Culicover 1970, 1972, Culicover & Jackendoff 1997) look on the face of it as if they are derived from imperative structures such as (291b), rather than other putative sources such as (291c, d).

- (291) a. One more step and I shoot.  
b. Take one more step and I shoot.  
c. #You will take one more step and I shoot.  
d. If you take one more step (\*and) I shoot.

However, cases like (291a) can indeed have parses in which they are conjunctions of two declaratives. Specifically, (291a) is an elliptical version of (292).

- (292) You take one more step and I shoot.

We independently know that structures like (292) are grammatical; compare the following example from Culicover & Jackendoff 1997 (their (3b)):

- (293) Big Louie sees you with the loot and he puts out a contract on you. (= If Big Louie sees you with the loot, he'll put out a contract on you.)

I will not address here why the declarative sentences in the left conjunct are interpreted as antecedents of conditionals, directing the reader to the references already cited and the references therein. However, the *form* of the left conjuncts in cases like (292), (293) is clearly declarative. Therefore, there is also a parse of cases like (291a) in which a declarative clause is elided, and so such cases do not threaten the generalization that fragments never contain elided imperatives.<sup>79</sup>

Having established the generalization that imperative clauses do not appear to undergo ellipsis, we should now consider what *is* in fact being elided in cases like *Both hands!*, and how a Question under Discussion is understood in such cases. I argue that, even though it does not ‘feel like’ there is a ‘question under discussion’ in the intuitive sense in the scenario where a child is unsteadily carrying a bowl of soup, nevertheless the use of a fragment can force such a QUD to be accommodated. That is, there is a question to which *Both hands!* is the answer in the given context. The likeliest candidate for what that question is would be ‘What should the child use to carry the soup?’<sup>80</sup>. Even though no-one has uttered this question explicitly, it does not seem outrageous to claim that in the given scenario, this could be understood as a Question under Discussion. Certainly it does not seem like a leap of accommodation to make it so. In that case, the clause that is being elided is the one that is QUD-GIVEN, namely *The child should use x to carry the soup*.

If such a sentence is what is contained within the ellipsis site, then this accounts for the apparent illocutionary force of the fragment as a command. Sentences containing *should* are declarative in form, but they can have the illocutionary force of commands, requests, or suggestions.

---

<sup>79</sup>I should note that even if all the syntactic arguments in this section turn out to be wrong, it would not threaten a QUD-GIVENness theory in general. We could always appeal to theories like that of Kaufmann 2012 to understand the *semantics* of imperatives as being (at some level) propositional, and so able to serve as the input to QUD-GIVENness.

<sup>80</sup>Or possibly ‘What should the child carry the soup with?’. This is underdetermined on the basis of this fragment alone, but note that *with both hands!* is also a felicitous utterance in this scenario.

- (294) a. You should close the door.  
b. You should take me out to dinner.  
c. You should go to that conference.  
Etc., etc.

To this extent, a fragment like *Both hands!* can be understood as having the illocutionary force of a command, even if its syntactic form is the declarative ~~*you should use both hands.*~~

To sum up, in this section I have discussed the advantages of a QUD-based theory of clausal ellipsis for understanding the widespread availability of antecedentless fragments. Even without explicit antecedents, we can understand such fragments as being cases of clausal ellipsis, with the antecedents pragmatically accommodated on the basis of the QUD-GIVENness condition.

However, the availability of antecedentless fragments raises the worry of ‘where the syntax comes from’: that is, are there still syntax-based constraints on the availability of clausal ellipsis? It is to this matter that I now turn.

### **3.7 Syntactic isomorphism and antecedentless fragments**

In the analysis of antecedentless fragments proposed above, I have been speaking in terms of ‘construing’ a particular syntax into an ellipsis site. This might suggest that the condition on ellipsis is wholly semantic, and that no notion of ‘syntactic isomorphism’ – that is, syntactic identity between an ellipsis site and an antecedent – is required. The availability of antecedentless fragments is of course a *prima facie* challenge to syntactic isomorphism being required – if there is no antecedent, then how can syntactic isomorphism possibly be a requirement on ellipsis?

The fact is, though, that if there *is* an available syntactic antecedent, then syntactic isomorphism *is* required between a fragment and that antecedent. For example, given an active antecedent, the fragment must be in active voice; and given a passive antecedent,

the fragment must be in passive voice, as the below English and German examples show (partially repeated from (97), originally Merchant 2010's (23)).

- (295) a. Who is sending you to Iraq? – Bush./\*By Bush.
- b. (i) Q: Wer hat den Jungen untersucht? A: \*Von einer  
 who.NOM has the boy examined? by a  
 Psychologin.  
 psychologist  
 'Q: Who examined the boy? A: [intended] (He was examined) by a  
 psychologist.'
- (ii) Q: Von wem wurde der Junge untersucht? A: \*Eine  
 by who.DAT was the boy examined a  
 Psychologin.  
 psychologist.NOM  
 'Q: Who was the boy examined by? A: [intended] A psychologist  
 (examined him).'

That is, the below derivations are impossible, even though the elided clauses are semantically identical to the versions with the other voice specification, and so are just as QUD-GIVEN.

- (296) a. Who is sending you to Iraq?  
~~I am being sent to Iraq~~ by Bush.
- b. Wer hat den Jungen untersucht?  
~~Der Junge wurde~~ von einer Psychologin ~~untersucht~~.
- c. Von wem wurde der Junge untersucht?  
 Ein Psychologin ~~hat den Jungen untersucht~~.

So it does look like syntactic isomorphism is at least somewhat a requirement – but only if there is material around for the ellipsis site to be isomorphic to.

In this section, I propose a formalization of this fact. The proposal will be that the lexical material inside an ellipsis site is subject to a constraint similar to that proposed in work by Chung, Ladusaw and McCloskey (Chung, Ladusaw & McCloskey 1995, Chung 2006, Chung, Ladusaw & McCloskey 2011, Chung 2013) namely that lexical material within an ellipsis site must be ‘re-used’ or ‘recycled’ from an available antecedent. This requirement explains the fact that, if we put the antecedentless cases aside temporarily, it is impossible to have material within a clausal ellipsis site which is not present in an antecedent. For example, the ungrammaticality of the voice mismatch cases in (296) can be accounted for on this view, if we assume that the specification for active or passive voice needs to be copied from an antecedent; in a voice-mismatch case, this copying obviously cannot happen. Other similar cases discussed by Chung, Ladusaw and McCloskey throughout the work cited above include ‘sprouting’ a preposition within the ellipsis site, and diathesis shift. The below examples are adapted from examples in Chung et al. 2011.

(297) *No ‘sprouting’ prepositions within an ellipsis site*

- a. (i) He’s jealous, but I don’t know of who ~~he’s jealous of~~.
- (ii) \*He’s jealous, but I don’t know who ~~he’s jealous of~~ t
- b. (i) Mary was flirting, but I don’t know with who ~~she was flirting~~.
- (ii) \*Mary was flirting, but I don’t know who ~~she was flirting with~~

(298) *Diathesis shift OK between sentences without clausal ellipsis...*

- a. (i) They embroidered something onto the tablecloth, but it’s not clear what they embroidered the tablecloth with.
- (ii) They embroidered something with peace signs, but it’s not clear what they embroidered peace signs onto.
- (iii) They served someone leek soup, but it’s not clear to whom they served leek soup.

(299) ... *but diathesis shift is not OK under ellipsis*

- a. \*They embroidered something onto the tablecloth, but it's not clear with what  
~~they embroidered the tablecloth t~~<sup>81</sup>
- b. \*They embroidered something with peace signs, but it's not clear onto what  
~~they embroidered peace signs t.~~
- c. \*They served someone leek soup, but it's not clear to whom ~~they served leek  
soup t.~~

The cases in (298) are severely unacceptable even though they should both be pragmatically understandable and recoverable from the linguistic context (the *of* in *jealous of* is essentially semantically vacuous, and if you are flirting, you must be flirting *with* someone). What is going wrong in these cases, Chung et al. 2011 argue, is that material (the preposition) is present in the ellipsis site which is not present in an antecedent. There is no 'source' for the 'copying'; the ellipsis site cannot be constructed, and ungrammaticality results.

In the cases in (299), we assume that there are two verbs *embroider* and *serve* with different argument structures.<sup>82</sup> The reason ellipsis does not allow an alternation of these argument structures is because, in the mismatch cases, there is no way of 'copying' a verb with a differing argument structure. The antecedent provides a different verb; if it is copied, it obligatorily brings its argument structure with it. Argument structure is therefore obligatorily preserved under ellipsis.

The empirical status of the argument therefore seems clear: there can be no gratuitous use of 'new' lexical material in an ellipsis site. We can formulate this in terms of the

---

<sup>81</sup>As Chung et al. 2011 point out, this is grammatical on the irrelevant reading in which the *with*-PP introduces an instrument, rather than the pattern/ornament.

<sup>82</sup>We could equivalently take a 'constructivist' view of argument structure alternations where the diathesis shift is a reflex of a difference in the selection of certain argument-introducing functional heads, rather than a lexical difference in the verb itself. The point goes through whichever view of argument structure we take; in either case, to allow for a diathesis shift under ellipsis, material (whether a lexical verb or functional argument-introducing heads) would have to be copied into the ellipsis site which has no antecedent.

constraint proposed by Chung 2006, which has come to be called the ‘no new words’ constraint.

(300) ‘No new words’ (Chung 2006’s (29))

Every lexical item in the numeration of the sluice that ends up (only) in the elided IP must be identical to an item in the numeration of the antecedent CP.

That is, there is no ‘return to the lexicon’, as Chung et al. 1995 put it.

The evidence provided above, from Chung, Ladusaw and McCloskey’s work, seem to force us into saying something like (300). However, in the preceding sections, we have seen many examples of cases of fragments where there is no linguistic antecedent, and so not every lexical item in the numeration of the elided clause can possibly be identical to any item in the numeration of an antecedent CP: there is no antecedent CP. I have been trying to defend the idea that these fragments are created via a process of ellipsis. How can this be reconciled with the constraint in (300)?

I propose that we can solve this dilemma by suggesting that the constraint in (300) is not immutable, but rather a violable constraint which has a conditional rider attached to it.<sup>83</sup>

(301) ‘No new words’ (violable version)

Every lexical item in the numeration of an elided clause that ends up (only) in the elided IP must be identical to an item in the numeration of the antecedent CP *if failing to do so would be ‘gratuitous’*.

What does it mean to ‘gratuitously’ fail to enforce identity between lexical items in an ellipsis site and an antecedent? Essentially, this means that (302a) is blocked, given the availability of (302b).

---

<sup>83</sup>An apparently very similar solution has recently been proposed by Elliott 2013. I have not yet been able to compare the two approaches in detail.



- (302) a. \*He's jealous, but I'm not sure who ~~he's jealous of~~.  
 b. He's jealous, but I'm not sure of whom ~~he's jealous~~.

(302a) includes a preposition in the ellipsis site which could well have been extracted and pronounced, as (302b) shows. The availability of (302b) blocks (302a); there is no reason to violate no-new-words, and so one must not.<sup>84</sup> The same point is made by the failure of (303a) below.

- (303) a. \*They sprayed something with water, but it's not clear onto what ~~they sprayed~~  
~~water~~.  
 b. They sprayed something with water, but it's not clear what ~~they sprayed with~~  
~~water~~.

In this case, the problem in (303a) is that one version of *spray* (the one with the frame *spray X with Y*) is in the antecedent, but a different version of *spray* (the one with the frame *spray Y onto X*) has to be understood in the ellipsis site. This is a violation of no-new-words. (303b) communicates exactly the same meaning as (303a), but (303b) uses the same version of *spray* in the ellipsis site as the antecedent. As such, (303b) does not violate no-new-words, and so blocks the availability of (303a).<sup>85</sup>

---

<sup>84</sup>This constraint is transderivational, then, and seems to involve competing candidate derivations in the same fashion as in Optimality Theory. In OT terms, we could talk of (302b) 'harmonically bounding' (302a) – that is, (302a) is the same as (302b) except that (302a) violates a constraint (no-new-words) that (302b) does not, and (302a) is therefore categorically dispreferred to (302b). While the theory presented here could be translated into OT terms, it's not clear that we would want to do this; among other reasons, we would then have to reckon with the typological predictions which OT would force us into making (thanks to Ellen Woolford for making this point particularly clear to me). I will stick here with the conditional formulation given in (301).

<sup>85</sup>Note that it would be very easy in principle to *accommodate* here the form of *spray* with a different argument structure from the antecedent, as Chung, Ladusaw and McCloskey point out throughout their work; however, the grammar just seems to rule this out. In my terms, this is because it would be a gratuitous violation of no-new-words to do so. As we will see below, if it would not be a gratuitous violation of no-new-words to accommodate new lexical material, such accommodation can be done.

We predict, however, that if violating no-new-words would *not* be ‘gratuitous’ – that is, if there is no possible competing elliptical<sup>86</sup> derivation which expresses the same meaning as one in which new lexical material appears in an ellipsis site – it should be possible to violate no-new-words. This is in effect a formulation of the ‘Last Resort’ proposal for sluicing made by van Craenenbroeck 2010a. Van Craenenbroeck argues that (clausal) ellipsis sites can differ syntactically from their antecedents just in case no other grammatical derivation would be possible.

The basic observation to start with is that given a sluice as in (304), it is not certain whether it should be given the analysis in (304a), where the sluice is isomorphic to the antecedent, or the analysis in (304b), where the sluice contains a cleft which is not isomorphic to the antecedent (Pollman 1975, Erteschik-Shir 1977); or whether both should be freely available.

- (304) Someone left, but I don’t know who.
- a. ... but I don’t know who ~~left~~.
- b. ... but I don’t know who ~~it was~~.

In general, it looks as if sluicing sites do not ‘prefer’ to contain clefts; that is, there are many cases where a cleft source does not seem to be available. For example, this appears to be the case in Greek. The pivot of a cleft in Greek always shows up in nominative case, as (305) (from Merchant 2001:127) shows.

- (305) I astinomia anekrine enan apo tous Kiprious prota, ala dhen ksero  
 the police interrogated one.ACC from the Cypriots first but not I.know  
 {pjos / \*pjon} itan.  
 who.NOM who.ACC it.was  
 ‘The police interrogated one of the Cypriots first, but I don’t know which it was.’

---

<sup>86</sup>See below for why this condition is included.

However, nominative case is barred in the corresponding sluice, apparently showing that the ellipsis site must contain *anekrine* ‘interrogated’ assigning accusative case, and cannot contain the cleft structure.

- (306) I astinomia anekrine enan apo tous Kiprious prota, ala dhen ksero  
 the police interrogated one.ACC from the Cypriots first but not I.know  
 {\*pjos / pjon} ⟨anekrine i astinomia⟩.  
 who.NOM who.ACC interrogated the police  
 ‘The police interrogated one of the Cypriots first, but I don’t know which (they  
 interrogated).’ (Merchant 2001:127)

On the basis of facts like this, Merchant 2001 argued that ellipsis sites in sluicing never contain clefts. However, it has become clear in subsequent work (Almeida & Yoshida 2007, Rodrigues et al. 2009, van Craenenbroeck 2010a, Barros 2012, Barros et al. to appear) that clausal ellipsis sites must potentially be able to contain cleft sentences. The below example from Barros 2012 makes this point.

- (307) a. Jack left and someone else did too, but I don’t know who.  
 b. (i) ... but I don’t know who ~~it was~~.  
 (ii) \*... but I don’t know who left.

In sluicing cases like (307a), the ellipsis site must contain a cleft. If the full sentence was contained within the ellipsis site, this would be a contradiction. To utter ... *but I don’t know who left*, the speaker has to lack even a partial answer to that question (Dayal 1996), and this is incompatible with the speaker asserting that John came to the party.

van Craenenbroeck 2010a proposes that clefts are possible in ellipsis sites, but as a ‘last resort’. We don’t want to make them generally available, because we would then lose an explanation for the Greek facts which show that the nominative case which would appear in a cleft is not generally available in sluicing cases. However, clefts do seem to be *possible* in sluicing, as (307) shows.

Here is how I propose to capture the ‘Last Resort’ condition in terms of the conditional formulation of ‘no new words’, i.e. ‘no new words if this would be gratuitous’. In the Greek cases, eliding a cleft rather than an isomorphic sentence would be gratuitous; there is no meaning difference between the cleft cases and the non-cleft cases, but the cleft case is not isomorphic to an antecedent (it has new words in the ellipsis site), and so is blocked by the syntactically isomorphic possibility.

In a case like (307a), the cleft sentence *it is* in the ellipsis site is also not syntactically isomorphic to any antecedent, and so eliding this clause violates no-new-words. However, this is licit in this case because there is simply no elliptical candidate, other than (307b-i), which can communicate the relevant meaning. Unlike in the *He’s jealous, but I don’t know \*(of) what* type of cases discussed by Chung, Ladusaw and McCloskey, there is no competing derivation for (307a) where a different ellipsis site communicates the same meaning.

I will pause here to briefly consider a question which might seem to arise from this line of argument: why does (308b) not block (308a)?

- (308) John came to the party, and someone else did too,
- a. . . . but I don’t know who ~~it was~~.
  - b. . . . but I don’t know who it was.

(308b) vacuously satisfies no-new-words (because there’s no ellipsis in it), and as such we might expect it to block (308a), which does violate no-new-words. Here is how I propose to view this. For any given derivation, it is decided at some point whether it is going to contain ellipsis or not. (This is modeled in e.g. Merchant’s work by whether the ellipsis-licensing [E]-feature is merged or not; other frameworks will model this differently.) However, once it is decided that a particular sentence is going to contain ellipsis, then that decision is final: the grammar is restricted, at that point, to working out what the ‘best’ ellipsis site is going to be. It is at this point that no-new-words kicks in: as a constraint which works out what

the ‘best’ ellipsis site could be. No-new-words only looks at elliptical derivations to find out which is the ‘best’; in a way it is a heuristic for deciding between differing ellipsis sites.<sup>87</sup> Sentences like (308b) then do not enter into its calculations, and so do not block sentences like (308a).

There are other cases which motivate the inclusion of a cleft structure in an ellipsis site, if no alternative is available. Take for example certain sluices which resemble left-branch extractions, such as (309).

- (309) a. John met a tall man, but I’m not sure how tall.  
 b. \*John met a tall man, but I’m not sure how tall he met a t man.

Given the ungrammaticality of overt left-branch extraction as shown in (309b), examples such as (309a) have often been taken to show that clausal ellipsis has the power to void such ungrammaticality effects, from Ross 1969 onward. However, Barros et al. to appear have argued that the source of (309a) is actually a cleft.

- (310) John met a tall man, but I’m not sure how tall ~~he is~~.

Morphological evidence for this fact comes from German and Dutch. In these languages, pronominal adjectives agree in Case with their noun, but adjectives in predicative position do not.

- (311) (Barros et al. to appear’s (29))  
 a. Der Mann ist groß(\*en).  
     the man is tall(.ACC)  
 b. Lena hat einen groß\*(en) Mann geheiratet.  
     Lena has a tall(.ACC) man married

---

<sup>87</sup>This is much easier to understand in comprehension terms: if someone hears an ellipsis site, no-new-words is one principle which guides them in the process of reconstructing what was in it. This bears similarity, then, to the ‘filling in a TP via copying’ model that Chung, Ladusaw and McCloskey propose for sluicing. As Chung et al. 2011:fn. 1 point out, it’s less clear how to model this on the production side of the grammar.

(312) (Merchant 2001:171)

- a. De man is lang(\*e).  
the man is tall(.ACC)
- b. Zij hebben een lang\*(e) man aangesteld.  
they have a tall(.ACC) man hired

This then gives us a test for whether an adjective is underlyingly in predicative position or prenominal position. In sluicing, the remnants show up without case marking, suggesting that the ellipsis sites contain clefts with predicative *be*, rather than left-branch extractions.

(313) (Barros et al. to appear's (29, 30))

- a. Lena hat einen großen Mann geheiratet, aber ich weiß nicht wie  
Lena has a tall.ACC man married but I know not how  
groß(\*en).  
tall(.ACC)  
'Lena married a tall man, but I don't know how tall.'
- b. Zij hebben een lange man aangesteld, maar ik weet niet how  
they have a tall.ACC man hired but I know not how  
lang(\*e).  
tall(.ACC)  
'They hired a tall man, but I don't know how tall.'

That is, this is evidence for the source of the above sluices being the non-isomorphic (314a), rather than the isomorphic (314b).

- (314) a. Lena married a tall man, but I don't know how tall ~~he was t~~.
- b. Lena married a tall man, but I don't know how tall ~~she married a t man~~.

The cleft syntax of the sluice in (314a) is forced by the fact that the alternative, (314b), would violate a constraint on movement.<sup>88</sup> In cases like (314a), no-new-words is again violated, but not gratuitously: there is just no other elliptical competitor which can communicate the same meaning without breaking some other (non-violable) constraint on syntactic representations (here the ban on left-branch extraction).

Having established how the violable version of the no-new-words constraint works in these cases, now let us consider the case of antecedentless fragments.

- (315) a. ~~That is~~ some guy she met at the park.  
b. ~~The taxi should go~~ to the train station.  
c. ~~You should use~~ both hands!

The mystery which we started this section with was that if a fragment is antecedentless, it violates no-new-words, which does not seem to be an option available to fragments which do have antecedents. The violable version of no-new-words, however, does not rule out cases like those in (315). The reason is that no-new-words, as discussed above, looks at the elliptical competitors, and ‘chooses’<sup>89</sup> the one which violates no-new-words the least. But there is no elliptical *competitor* in the cases like (315) which does *not* violate no-new-words. Obviously all potential elliptical derivations here will violate no-new-words, and as such, none of them *gratuitously* violate no-new-words. That is, there is no competing derivation for any of the cases in (315) which would block the forms that we actually see.

---

<sup>88</sup>Barros et al. to appear’s aim is to show, contra much previous work, that clausal ellipsis does not in fact alleviate constraints on movement; the data presented above from left-branch extractions are some of their key data in support of this conclusion. I will assume that their position is correct, at least for the case of left-branch extractions. See section 4.5 for more discussion of this issue.

<sup>89</sup>Talking about no-new-words ‘choosing’ an ellipsis site is just a convenient metaphor: no-new-words is not a selection algorithm, but rather a constraint which derivations may violate (perhaps multiple times). The grammar as a whole chooses the derivation which incurs the fewest violations of any violable constraints.

There may in fact be a sense in which no-new-words is in fact operative and ‘picks between’ different ellipsis possibilities even when fragments have no linguistic antecedent. Note the contrast between the below cases.<sup>90</sup>

- (316) Context: A comes in and discovers that on the kitchen table, where there should be a beautiful roasted leg of lamb, there is only a greasy plate. A looks at B and raises his eyebrows. B explains:
- a. The dog.
  - b. ??By the dog.

The antecedentless fragment in (316a) is reasonably easily understood as *The dog ate the leg of lamb*. However, for some reason (316b) is degraded, even though *The leg of lamb was eaten by the dog* should be an available source for the ellipsis. (316b) is degraded even though we might consider it a more easily accommodable fragment than (316a) (for example (316b), by using a *by*-phrase, provides us with the information that the dog was the agent of some event, which (316a) does not tell us).

We might understand what is going on here by supposing that those two ellipsis sites (~~ate the leg of lamb~~ and ~~the leg of lamb was eaten~~, respectively) are both taken into consideration by the no-new-words constraint. By some metric of complexity – perhaps, for example, the number of functional heads which need to be projected in each of these elided clauses – the passive ellipsis site here might be considered more complex, and consequently dispreferred by no-new-words in comparison with the active ellipsis site.

This suggestion is highly speculative, and I won’t try to formalize this more here: clearly much more work would need to be done to understand if the contrast in (316) is to be understood in terms of no-new-words, and in what sense passive ellipsis sites are

---

<sup>90</sup>I believe it was Ellen Woolford who first pointed out contrasts like (316) to me.



‘more complex’ or ‘contain more words’ than active ellipsis sites.<sup>91</sup> However, hopefully the intuitive appeal of the idea is clear.

In this section, then, I have argued that there is a requirement that ellipsis sites match an antecedent, but this constraint is violable. The condition is that there must be no ‘gratuitous’ violation of a constraint on copying lexical items into an ellipsis site. ‘Gratuitous’ here means that a derivation which violates no-new-words – i.e. a derivation which has material in its ellipsis site which is not present in an antecedent – will be blocked by the existence of an elliptical derivation which does not violate no-new words. However, the requirement that an ellipsis site only contain lexical material which has been introduced by an antecedent is not a ‘hard’ constraint; it can be violated if circumstances require. This allows us to understand antecedentless fragments, and also models the ‘Last Resort’ nature of non-syntactic isomorphism discussed by van Craenenbroeck 2010a; a lack of syntactic isomorphism in an ellipsis site is only permitted if there is no other elliptical candidate which (a) is grammatical and (b) expresses the correct meaning.

We have seen in the preceding sections that a QUD-GIVENNESS model of the antecedence condition on clausal ellipsis, combined with a conditionalized version of the ‘no-new-words’ constraint of Chung 2006, accounts for the availability of fragments without linguistic antecedents, as well as enforcing syntactic identity requirements in cases where fragments do have overt antecedents. On the assumption that the clausal ellipsis in fragments is the same process as clausal ellipsis in sluicing constructions, such as *John ate something but I don’t know what*, then in the best of all possible worlds, the antecedence condition on clausal ellipsis here defended for fragments should extend unproblematically to sluicing. I now turn to this issue.

---

<sup>91</sup>The idea here is that the passive is marked compared to the active, which is intuitively true, but it’s not clear how this intuition translates into formal terms.

### 3.8 Extension to sluicing

We are supposing, following Merchant 2004, that fragments and sluicing cases like those in (317) receive essentially the same analysis as cases of clausal ellipsis.

- (317) a. Someone left, and I don't know who.  
b. John danced, but I don't know with who/who with.  
c. Lots of people were at the party; I'm trying to find out how many.  
d. JOHN was at the party, but I'm not sure who else.

Such cases should then be subject to QUD-GIVENNESS. However, *prima facie*, this does not immediately work as expected. Consider the below dialogue.

- (318) A: What happened?  
B: Someone left, but I don't know who ~~left~~.

Here, the ellipsis-containing clause is *who left*. So we want the below condition to hold.

$$(319) \quad \exists Q \in QUDStack. \bigcup Q \Leftrightarrow \bigcup \llbracket \text{who left} \rrbracket^F$$

I assume here, following Beck 2006, that the focus value of a question is the same as its ordinary semantic value – that is, *wh*-words are alternatives generators, and a *wh*-question denotes a set of propositions which vary with respect to the questioned constituent. That is,  $\llbracket \text{who left} \rrbracket^F = \llbracket \text{who left} \rrbracket = \{\text{John left, Mary left, Sue left} \dots\}$ ; and  $\bigcup \llbracket \text{who left} \rrbracket = \exists x.x \text{ left}$ . Is there a question  $Q$  somewhere on the QUD stack whose union mutually entails the union of the question ‘Who left’? The answer seems to be no; the only ‘live’ question in (318) is ‘What happened?’, whose union (roughly ‘Something happened’) would not entail the union of ‘Who left’ (i.e. ‘Someone left’).

However, we have already seen that the QUD is malleable in discourse. One of the ways it appears to be manipulable is via the use of indefinites like *someone*. This was discussed already in section 3.2.2, and the importance of such cases for sluicing has been discussed by AnderBois 2010; recall the sort of contrast presented below:

- (320) a. Someone left, but I don't know who.  
b. \*It's not the case that no-one left, but I don't know who.

Here, the indefinite *someone* in (320a) seems able to raise the question 'Who was it that left?' in a way that (320b) – which has identical truth-conditional content – does not. We could understand indefinites, then, as having the power to add to the QUD stack; in this case, a question like 'Who left?' is added. It is this question that the sluice is then anaphoric to, in a sense inspired by (but not identical to) AnderBois 2010's analysis of sluicing.

This works more directly for a case like the below, where a sentence which provides the antecedent for a sluice has focus intonation.

- (321) JOHN was at the party, but I'm not sure who else ~~was at the party~~.

Here, the focus intonation on *John* presupposes that there is a Question under Discussion 'Who was at the party?'. We have already discussed the ability of focus in an antecedent to presuppose a particular QUD, and thereby license clausal ellipsis, in the discussion of fragments in section 3.3.2.2; for detailed discussion of the interaction of focus and the QUD, see Roberts 2012/1996. The analysis already provided for fragments can be taken over unproblematically to sluicing cases like (321); so in these cases, the QUD-GIVENNESS condition looks like it can be applied in both fragments and sluicing, a welcome result for the hypothesis that both of these constructions involve clausal ellipsis.

But there are cases in which this approach does not quite work. These are cases of so-called sprouting: cases where the *wh*-phrase in the sluice has no overt correlate in an antecedent, such as (317b). Chung et al. 2011, citing Chung 2006, also note a number of other such cases which pose problems for a semantic identity requirement.

- (322) (Chung et al. 2011's (36))  
a. He put in a bid but I couldn't tell on whose behalf.  
b. She went to the movies but we don't know who with.

- c. She finished the project but we don't know with whose help.
- d. He's on the no-fly list but it's totally unclear for how long.

As Chung et al. 2011 point out, it's not clear that there is any sort of semantic equivalence relation here between the ellipsis-containing clause and the antecedent. For example, Merchant 2001's e-GIVENNESS (existentially closing the antecedent and the elided clause, and requiring mutual entailment between them) would not hold of these cases, because the below entailments do not go through.

(323) Entailments which do not succeed:

- a. he put in a bid  $\Rightarrow$  he put in a bid on someone's behalf
- b. she went to the movies  $\Rightarrow$ she went to the movies with someone
- c. she finished the project  $\Rightarrow$ she finished the project with someone's help
- d. he's on the no-fly list  $\Rightarrow$ he's on the no-fly list for some length of time<sup>92</sup>

It's not clear that a QUD-based account will do any better; the clearest Question under Discussion in a case like (322a), for example, is plausibly 'What did he do?', and the closure of this (roughly 'He did something') does not entail the closure of 'on whose behalf did he put in a bid' (roughly 'He put in a bid on someone's behalf').

We could try to solve the problem for e-GIVENNESS here (and hopefully by extension also solve the problem for QUD-GIVENNESS) by suggesting that the entire moved phrase (and not just the *wh*-part of it) is in focus, and gets existentially closed. In all of the cases above, the sprouted phrase is an event description. If the whole event description is existentially closed, perhaps what results is so general that mutual entailment is in fact met.

To see more clearly what I mean, assume some (simplified) semantic denotations as below:

---

<sup>92</sup>Chung et al. 2011 state that this entailment does not go through. It seems to me that there actually is (mutual) entailment here, but clearly this does not invalidate the general point, in the light of the failure of the entailments in (323a-c).

- (324) a.  $\llbracket \text{with John} \rrbracket = \lambda e. e \text{ was performed with John}$   
 b.  $\llbracket \text{go to the movies} \rrbracket = \lambda e. e \text{ is an event of going to the movies}$   
 c.  $\llbracket \text{go to the movies with John} \rrbracket = \lambda e. e \text{ is an event of going to the movies \& } e \text{ was performed with John}$   
 (Composition of (a) and (b) via Predicate Modification)  
 d.  $\llbracket \text{Mary went to the movies with John} \rrbracket = \exists e. e \text{ is an event of going to the movies \& } e \text{ was performed with John \& Mary is the agent of } e$   
 (Several steps, including the introduction of the agent and the existential closure of the event argument, omitted)

Now suppose that in a case like *with whom she went to the movies*, *with whom* is in focus and gets focus-closed. That is, it is replaced with a variable of the appropriate type (that is, of type  $\langle \text{ev}, t \rangle$ , where ‘ev’ is the type of events), and existentially closed. Then we have:

- (325)  $\text{F-clo}(\text{with whom Mary went to the movies}) = \exists P_{\langle \text{ev}, t \rangle}. \exists e. e \text{ is an event of going to the movies \& } P(e) \text{ \& Mary is the agent of } e$   
 i.e. there was an event of Mary going to the movies, and there was a description  $P$  that held of that event, i.e. Mary went to the movies ‘in some fashion’.

But now mutual entailment *does* hold between the focus-closure of the antecedent and the focus-closure of the elided clause.

- (326) Mary went to the movies, but we don’t know with whom.  
 a.  $\text{F-clo}(\text{Mary went to the movies}) = \text{Mary went to the movies}$   
 b.  $\text{F-clo}([\text{F with whom}] \text{ Mary went to the movies}) \approx \text{Mary went to the movies in some fashion}$

It does seem as if (326a) and (326b) mutually entail each other – it is certainly difficult to imagine a situation in which one could be true and the other not. The same applies for the other such cases in (322).

A problem for this account, however, is that it is simply not clear that focus can ‘take over’ pied-piped phrases in the way suggested here. We do not want the interpretations of such sprouting cases to proceed as if the entire sprouted *wh*-phrase, including the preposition, is in focus. Alternatives are computed with respect to the focused material itself – the *wh*-word or the stressed constituent – and not with respect to the whole phrase which it pied-pipes (see also Krifka 2006 on this point). We can see this in cases like the below.

(327) Mary went to the cinema, but I don’t know with who ~~Mary went to the cinema~~.

*only means:* I don’t know which person is such that Mary went to the cinema with that person.

*cannot mean:* I don’t know how Mary went to the cinema.

(i.e. the question cannot range over just anything of the type of the event description *with who* (*with John, happily, this evening, . . .*), but rather ranges only over individuals)

(328) Mary went to the cinema last night. — Yes, but only with John ~~Mary went to the cinema~~.

*only means:* John is the only person such that Mary went to the cinema with that person.

*cannot mean:* ‘with John’ is the only way in which Mary went to the cinema

In (327), the question is a question about people, not about manners. There is no interpretation of this question where the alternatives generated are alternatives over event descriptions. And in (328), *only* clearly may only make reference to the alternatives projected by *John*, even though the entire PP *with John* appears as a fragment. The use of *only* here does not say that ‘with John’ was the only manner in which Mary went to the cinema.

Note that it wouldn’t do here to claim that (327) and (328) simply do not have sensible interpretations, or have interpretations which are pragmatically ruled out, if the entire PP in each case is focus-marked. That claim is indeed true: in (327), we could imagine that if the

speaker wanted to ask about manners in general, she would have used *how* as the *wh*-word, not *whom*. And it could not literally be true in (328) that the only way of describing the event of Mary's going to the cinema was with the description 'with John'. However, this objection only serves to make the point further. The ellipsis condition, as revised above, would require that the whole PP was focus-marked (and closed under F-closure). That is how Chung et al. 2011's objection, that the entailments in (323) do not go through, is circumvented on the proposed 'fix': we existentially close event descriptions. However, the only available actual *interpretation* of the clausal ellipsis cases in (327), (328), is one in which the DPs *who*, *John* (and *not* the whole event description *with whom*, *with John*) are questioned or focused respectively. Applying the fix proposed here to the ellipsis condition, then, would require that the notion of focus-marking which was relevant for F-closure be different from the notion of focus-marking which question semantics or particles like *only* make reference to. This would clearly be a suboptimal situation.

So given this evidence from other cases of focus, it does not look like the argument explored above will solve Chung et al. 2011's objection to the semantic antecedence condition. I still hold, however, that QUD-GIVENNESS can meet the challenge that sprouting data pose. The argument I intend to make is this. Following the arguments made in section 3.6.3, I argue that new QUDs can be accommodated. This is how antecedentless fragments get interpreted on the account proposed here. Consider a case like (329).

(329) Mary went to the cinema, but I don't know with whom ~~she went to the cinema~~.

Here, the QUD is likely to be something like 'What did Mary do?' or 'What happened last night?'. As discussed above, neither of these QUDs provide an appropriate antecedent for the ellipsis site, on a QUD-GIVENNESS analysis. However, I propose that a relevant QUD is easily accommodated.

The logic proceeds in the same way as for the fragment case. We have an elided clause, which denotes a question, and its pronounced part is *with whom*. QUD-GIVENNESS requires

that the denotation of this question match the denotation of a QUD. Therefore, we have the presupposition, brought about by the ellipsis, that there must be a QUD which has something to do with who someone did something with. Given the dialogue which precedes the sluiced clause, it is reasonable to assume that the QUD which the elided clause is making reference to is now about who Mary went to the cinema with. There is also a syntactic antecedent which provides a source for ‘copying’ into the sluicing site (following the proposal in section 3.7 and ultimately following Chung et al. 2011).

This analysis suggests that in a sense, sluices are ‘self-licensing’: they denote questions, and the very form of a sluicing remnant, combined with the fact that sluicing shows overt question syntax and morphology, and with the syntactic ‘copying’ requirement on ellipsis discussed in section 3.7, signals the QUD which needs to be accommodated in order to license the ellipsis in the sluice.

This analysis may help to explain the contrast in cases like the below.

(330) Did John go to the cinema?

- a. ?With Mary.
- b. Yeah, with Mary.

(331) John went to the cinema.

- a. Who with?/With who?

The contrast here is not strong, but there is a feeling that the answer in (330a) is slightly inappropriate, and degraded with respect to (330b). By contrast the sluicing case in (331a) is fine. We can understand this as a difficulty in accommodating a new QUD in (330a). The answer in (330a) has to be QUD-GIVEN. There is a live QUD ‘did John go to the cinema?’. But this QUD does not on its own license the ellipsis ‘with Mary ~~John went to the cinema~~’, for the sort of reason that Chung et al. 2011 discuss; the question of whether John went to the cinema or not does not stand in the relevant semantic relation with the question of who John went to the cinema with. That new question has to be accommodated



on the basis of the fragment, but that accommodation of a new QUD requires a little bit of ‘work’; and pragmatically, it’s not a very cooperative move to raise that new QUD, given that there was already a QUD which the interlocutor expected an answer to. That is why (330b) is an improvement: *Yeah* settles the QUD ‘did John go to the cinema?’, and allows a new QUD, ‘who did John go to the cinema with?’, to be introduced by the fragment *with Mary*. Similarly, (331) is an improvement because the sluice, which clearly denotes a question, is already of the right type to ‘set up’ its own QUD, without having to compete with an existing one.

The proposal that this sort of ellipsis can ‘shape’ an appropriate antecedent through accommodation is of course not new; Fox 1999 makes an influential such proposal, for example. Chung et al. 2011 express skepticism about such proposals: ‘The challenge, it seems to us, would be to constrain accommodation so that it would permit sluicing in [(332a)] for instance, but not in many of the ill-formed cases [like (332b)]’.

- (332) a. Mary went to the cinema, but I don’t know with whom ~~she went to the cinema~~.
- b. \*Mary’s jealous, but I don’t know who ~~she’s jealous of~~.

On the account proposed here, this challenge is met by saying that there is a role *both* for a syntactic ‘copy’ constraint on ellipsis, as discussed in section 3.7, *and* for a semantic, GIVENNESS-type constraint on elided material. It seems that both are needed to cover the complete range of data. It is the syntactic condition that rules out cases like (332b); in such cases, there is ‘gratuitous’ elision of syntactic material (the preposition *of*) which is not present in any antecedent. By contrast, no such syntactic problem presents itself in (332a); the only unspoken material<sup>93</sup> is material which is present in a pronounced antecedent. The

---

<sup>93</sup>Allowing for an alternation between full DPs and pronouns, and other such changes which are presumably somehow harmless, and which seem required to account for phenomena such as vehicle change.

syntactic and semantic conditions therefore work together in order to force the accommodation of a certain QUD.

I have argued in this section that the QUD-GIVENNESS condition can extend to sluicing as well as fragment answers, a welcome result. This section is of course far too short to encompass all of the questions posed by the antecedence conditions on sluicing; no doubt many questions remain. However, I hope to have shown that QUD-GIVENNESS is at least a viable contender for the title of the semantic identity condition in sluicing, building on the work by Ginzburg & Sag 2000, Merchant 2001, 2004, Reich 2007, AnderBois 2010, Collins et al. 2014.

### **3.9 Conclusion**

In this chapter, I have defended a QUD-based semantic antecedence condition for fragment ellipsis. This condition, combined with the independently required device of domain restriction, accounts for the surprising behavior of ‘presupposition inheritance’ in fragment answers, discussed by Jacobson 2013. In addition, it correctly predicts that only some utterances – those that set Questions under Discussion – can be antecedents for clausal ellipsis. Combined with a conditionalized version of the ‘no-new-words’ constraint proposed by Chung 2006, it also provides a way of understanding antecedentless fragments, without either having to suppose that a linguistic antecedent can be ‘made salient’ by context, or that fragments are ‘bare’ subsententials which combine with Mentalese properties to receive a propositional interpretation, as argued in Stainton’s work.

On this view, fragments always contain clausal structure, but clausal structure which goes unspoken. Having analyzed the semantic constraints which hold of that structure, in the next chapter, I turn to the syntactic constraints.

## CHAPTER 4

### FRAGMENTS AND THE SYNTAX OF CLAUSAL ELLIPSIS

#### 4.1 Introduction

We have seen in chapter 2 a number of arguments for the presence of covert clausal structure in sentence fragments. In this chapter, I will analyze some of the syntactic properties of fragments.

If fragments are the result of clausal ellipsis, then an account is needed of the fact that the ellipsis involved appears to target a string which is not a constituent. For example, in the dialogue below, the putative elided string *John ate* is not a constituent.

- (333) a. What did John eat? — Cake.  
b. ~~John ate~~ cake.

At least since Lobeck 1995, ellipsis is a process which has been argued to apply only to constituents, and a lot of the technology which has been developed to account for the licensing of ellipsis (for example, Lobeck's licensing heads, or Merchant 2001, 2004's E-feature) have explicitly made ellipsis the property of certain heads, which elide their complements. As the complement of a head will always be a phrase, models such as these predict that only phrases will elide, a prediction that is borne out in the simplest cases of verb phrase ellipsis and noun phrase ellipsis:

- (334) a. John should [<sub>VP</sub> eat more kimchi ], and Mary should [~~VP eat more kimchi~~]  
too.  
b. John saw three [<sub>NP</sub> red cars], and Mary saw two [~~NP red cars~~].

However, there are a number of cases which look on the surface like ellipsis but in which the deleted material is not a constituent. If fragments are to be analyzed as elliptical, then fragments fall into this category, as shown in (333) above. A number of other such examples are given below.

- (335) a. *Pseudogapping*
- (i) John was editing his prospectus, and Mary was her dissertation.
  - (ii) John would eat natto for a bet, and I would durian.
  - (iii) I know more French than I do Spanish.
- b. *Swiping*
- (i) He's traveling at the moment. – Where to?
  - (ii) He's traveling at the moment, but I don't know where to.
  - (iii) He's laughing, but I don't know what about.
- c. *Gapping*
- (i) John will eat sushi and Mary natto.
  - (ii) Andrew studies syntax and Elizabeth semantics.
- d. *Why-stripping*
- (i) John was eating natto. Why natto?
  - (ii) Mary left. Why Mary?

In order to account for such cases, a very common strategy in the literature has been to assume that ellipsis actually *is* acting on a constituent in these cases. However, a focused subconstituent has undergone movement to a position above the c-command domain of the ellipsis-licensing head. In all of the above cases, a constituent is elided, but the movement operation that allows a subconstituent to evacuate the ellipsis makes it look as if the string

which is eliding is not a constituent. Some examples of this shape of analysis for each of the cases given above are given below.<sup>94</sup>

- (336) a. John would eat natto for a bet, and I would [<sub>XP</sub> durian<sub>1</sub> [~~VP eat t<sub>1</sub>~~]]  
 (Lasnik 1999)
- b. He's traveling at the moment. — [<sub>CP</sub> Where<sub>1</sub> [<sub>FocP</sub> [<sub>PP</sub> to t<sub>1</sub> ]<sub>2</sub> [~~TP he is traveling t<sub>2</sub>~~]]]  
 (Hartman & Ai 2007)
- c. John will [<sub>&P</sub> [<sub>VP</sub> eat sushi ] and [<sub>VP</sub> Mary [<sub>VP</sub> [~~VP eat t~~] natto ]]]  
 (Coppock 2001)
- d. John was eating natto. Why [<sub>FocP</sub> natto<sub>1</sub> [~~TP John was eating t<sub>2</sub>~~]]  
 (Yoshida et al. 2013, Weir to appear)

As discussed in section 2.2, Merchant 2004 adopts this analysis also for fragments; a pronounced fragment is an instance of clausal ellipsis from which a focused constituent has moved.

- (337) a. What did John eat? — Chips.  
 b. Chips<sub>i</sub> [~~TP he ate t<sub>i</sub>~~]

I believe that this is a correct analysis, but only up to a point. In this section, I will show that, while there is indeed evidence for movement being involved in the derivation of fragments, this evidence conflicts with a number of other diagnostics which appear to show that fragments are not movement structures. I propose to resolve this conflict by arguing that fragments do undergo movement, but only at the level of Phonological Form (PF);

---

<sup>94</sup>I provide representative examples of the strategy of movement-plus-ellipsis in each case. These are not the only possible analyses for these phenomena. Analyses which do not rely on moving the 'remnant' out of an ellipsis site have also been proposed for gapping (Johnson 2009) and for the preposition in swiping (Ross 1969). While there seems to be a general consensus that movement is involved in the derivation of pseudogapping, there is debate about the precise nature of that movement; see e.g. Jayaseelan 1990 and Takahashi 2004.

at Logical Form (LF), fragments are interpreted *in situ*. This argument is the one made by Aoun & Benmamoun 1998 and Sauerland & Elbourne 2002 for similar cases of uninterpreted movement. Proposing that movement does take place, but only at the level of PF, allows us to understand the conflicting evidence which movement diagnostics show in fragments.

## 4.2 Some challenges to the movement analysis of fragments

Merchant 2004 adduces a number of arguments for the presence of movement in fragment constructions, most of which have already been reviewed in section 2.2. In general these arguments make a convincing case for a movement derivation; however, in this section, I review some evidence which appears to challenge Merchant's generalizations.

### 4.2.1 NPIs: licit fragments or not?

Merchant 2004 notes that negative polarity items (NPIs) do not front in English, but that certain NPIs can front in certain other languages, such as Irish. Merchant proposes that there is a correlation between the NPIs which can front (in various languages) and the NPIs which can be fragment answers.

(338) *NPIs cannot front in English* (Merchant's (106))

- a. Max didn't read anything.
- b. \*Anything, Max didn't read.

(339) (*Merchant's claim:*) *NPIs cannot be fragment answers in English* (Merchant's (105))

- A: What didn't Max read?
- B: \*Anything.

(340) *The Irish NPI rud ar bith ‘anything’ can front* (Merchant’s (111), data attributed to James McCloskey p.c.)

- a. Rud ar bith ní-or cheannaigh mé.  
thing any NEG-PAST bought I  
‘I didn’t buy anything.’

(341) *The Irish NPI rud ar bith can be a fragment answer* (Merchant’s (112), data again due to McCloskey p.c.)

- a. Caidé (a) cheannaigh tú?  
what C bought you  
‘What did you buy?’
- b. Rud ar bith.  
thing any  
‘Nothing.’

However, I believe that these data do not necessarily allow us to conclude that movement must be implicated in the generation of fragment answers. Firstly, the fact that NPI fronting in English is ungrammatical does not lead us to the prediction that NPIs should be ungrammatical fragments. In general, the type of fronting which Merchant proposes for the creation of fragments would be ungrammatical in non-elliptical contexts, as shown in (342). While topicalization is licit in English, the fragments in fragment answers are foci, not topics; and focus movement to the clausal left periphery in English is only licit in a restricted set of cases, discussed by Prince 1981. Generally, entity-denoting DPs, like *chips*, cannot front, as (342b) shows.

(342) What did you eat?

- a. Chips.  
b. \*Chips, I ate t.

As such, the putative ungrammaticality of NPI fragments does not necessarily speak for or against the fronting analysis of fragments; there may be other reasons why examples like (339) are bad in English. And in fact, as pointed out by den Dikken et al. 2000, Valmala 2007, there are a number of cases of NPI fragments which are acceptable (their judgments shown).

(343) (Valmala's (23))

What doesn't Max want to read? — Any mystery novels.

(344) (Den Dikken et al.'s (12b))

What didn't John buy? — ?Any wine.

(345) a. Q: (I know some of the books that Max did read, but) what DIDN'T he read?

A: Any books by Stephen King.

b. Q: Which files shouldn't I delete?

A: Any of them!

I agree that Merchant's example with *anything*, given in (339) above, is ungrammatical. However, I believe the source of this ungrammaticality is not to be attributed to an illicit fronting operation. Rather, the source of the problem is the fact that the question must contain a negator (in order to provide a licenser for the NPI in the ellipsis site in the answer); i.e. the question has to be of the form *What didn't Max read?*. To my ear, such a negative question is fairly infelicitous out of the blue, and rather has to be embedded in a context such as *I know some of the books that Max did read, but what didn't he read?*. That is, a contrast set of 'things Max read' needs to be established in order to make the question felicitous in the first place. Given the existence of such a contrast set, the reason for the infelicity of the answer *anything* in this context is not because NPIs cannot be fragments, but rather because it would assert that the set of things Max read is empty, which conflicts



with the requirements of the negative question.<sup>95</sup> As den Dikken et al. 2000 point out, when a context containing relevant things that Max did or did not buy is provided, both the question and the NPI fragment answer become much more appropriate.

(346) (Den Dikken et al.'s fn. 3, (i, ii), adapted)

- a. John has returned with the shopping for the party. A and B know that he bought bread, cheese, olives, and juice, but suspect that he has forgotten something.
- b. A: What didn't he buy? B: Any wine.

I conclude from this that NPIs are not in general illicit as fragments. Another piece of evidence for this conclusion is the fact that NPI fragments are licensed in utterances which are interpreted as questions:

(347) [A and B are at a party. A nods towards a figure whom he half-recognizes and asks B:]  
Anyone you know? (= ~~Is that~~ anyone you know?)<sup>96</sup>

If NPIs can in general be fragments, this poses a problem for the movement analysis of fragments. The issue is not so much that NPIs do not move to a left-peripheral position in non-elliptical cases; as discussed above, if the movement analysis of fragments is to have any hope at all, we need to in some way loosen the constraints on focus movement to the left periphery in English, so we could imagine that whatever is doing that work for us in the

---

<sup>95</sup>I do not know why this should contrast with the Irish case. However, it is worth noting that there is no negation in the question in (341). How the negation is then construed in the ellipsis site in order to license the NPI is not clear; I won't try to address this issue here.

<sup>96</sup>However, this example may represent the kind of 'left-edge' phonological deletion investigated by Napoli 1982, Weir 2012.

general case also extends to allowing NPIs to front.<sup>97</sup> The issue is, rather, that NPIs must always be c-commanded by their licensing elements at surface structure.

- (348) a. The soda, he didn't drink.  
b. \*Any of the soda, he didn't drink.

If the surface structure of fragment answers are created by movement of NPIs to a left-peripheral position, as in (349), then the NPI would not be c-commanded by a negative element, and so the answers should be ungrammatical.

- (349) a. What didn't he drink?  
b. [<sub>CP</sub> Any of the soda [<sub>TP</sub> ~~he didn't drink~~ t]]

These facts would seem to suggest that the NPI fragment is, at least for the purposes of licensing, in a position below negation, and so appears to weigh against an analysis in which the fragment has moved.

#### 4.2.2 *Each... the other*

Another way in which fragments pattern differently from 'normal' cases of A'-movement comes from the behavior of *each* binding the anaphor *the other*. As (350) shows, *each* appears to have to c-command *the other* at surface structure. Movement bleeds this relationship, and ungrammaticality results.

- (350) a. Each of them hates the other.  
b. \*The other, each of them hates.  
c. ??Which of the others does each of them hate?  
d. ??It's the other that each of them hates.

However, no such result obtains if *the other* is given as a fragment answer, as (351) shows.

---

<sup>97</sup>Plausibly, for example, the reason that NPIs do not front in English is that only topics front in English (in the non-elliptical case), and NPIs cannot be topics, as Giannakidou 2002 argues.

(351) Who does each of them hate? – The other.

This casts doubt on the hypothesis that movement is involved in the derivation of (351).

#### 4.2.3 Predicate fragment answers and inverse scope

Barss 1986 and Huang 1993 note that inverse scope is bleeded under predicate fronting.

- (352) a. John refused to teach every student.  
(refuse > every, every > refuse)
- b. . . . and teach every student, John refused to.  
(refuse > every, \*every > refuse)

(352a) has a reading in which John made a refusal to teach all the students, but may have agreed to teach some (refuse > every); (352a) also has an inverse scope reading in which John flatly refused to teach *any* student, that is, for every student, John refused to teach that student (every > refuse).<sup>98</sup> By contrast, (352b) only has the former of these readings.

However, in a predicate fragment answer, both scopes are possible.<sup>99</sup>

- (353) What did John refuse to do? — Teach every student.  
(refuse > every, every > refuse)

This asymmetry between predicate fronting and fragments answers casts doubt on the hypothesis that movement is involved in the derivation of (353).

---

<sup>98</sup>The example discussed by Huang 1993 is *teach every student, no-one will*. I have changed the example because, in my idiolect, I find inverse scope even in the version of this sentence without fronting *No-one will teach every student* – i.e. the reading where no students get taught by anyone – difficult to access, so I find it difficult to judge if this reading is bleeded in predicate fronting.

<sup>99</sup>This is my judgment, but there appears to be some speaker variation on this. Jeremy Hartman (p.c.) informs me that for him, (353) patterns with (352b) rather than (352a). I don't have anything to say about the source of this variation.

#### 4.2.4 Bare quantifier phrase answers

Merchant 2004 notes an objection to the movement-plus-ellipsis account of fragments, attributing it to Chris Potts p.c. Postal 1993 notes that quantifier phrases ('bare' quantifier phrases, that is, those which do not include exceptive phrases like *but John* or relative clause modifiers of their NP) do not undergo left-dislocation in English. However, they are perfectly acceptable as fragment answers.

- (354) a. ??{Everyone/Someone}, they interviewed t.  
b. A: Who did you interview?  
B: Everyone/Someone.<sup>100</sup>

It is possible that the source of the ungrammaticality of the fronting examples in (354a) has to do with information structure rather than restrictions on movement *per se*; only contrastive topics front in English (at least outside of putative elliptical contexts such as the movement-plus-ellipsis approach to fragments), and perhaps bare quantifiers just don't make good contrastive topics. However, these bare quantifiers continue to be degraded even when placed in focus-movement structures such as clefts.

- (355) ??It was {everyone/someone} that they interviewed t.

Given this resistance of bare quantifiers to movement, the grammaticality of the fragments in (355b) presents the movement-plus-ellipsis approach to fragments with a problem.<sup>101</sup>

---

<sup>100</sup>Clearly the answer *someone* here is very uncooperative, but it is obviously not ungrammatical in the sense that the fronting example is.

<sup>101</sup>Merchant also notes, again crediting Chris Potts p.c., that Postal 1998 claims that names cannot be fronted; however, they can be perfectly good fragments:

- (i) a. ??Fido, they named him.  
b. A: What did they name him?  
B: Fido.

The problem here is that (ia) is not a good case of *topicalization*; that is, it cannot be pronounced with a rise-fall-rise contour on *Fido*. However, Prince 1981 gives (ia) (her 38a) as precisely a case in which *focus* movement *is* licit in English. That is, (ia) is grammatical with focal stress (pitch accent) on *Fido* and de-

#### 4.2.5 Particles

Particles, or intransitive prepositions, do not move in English.

- (356) a. He looked up.  
b. He breathed oxygen in.  
c. He turned the TV on.  
d. He moved the box inside.

- (357) a. \*Up, he looked t.  
b. \*In, he breathed oxygen t.  
c. \*On, he turned the TV t.  
d. #Inside, he moved the box t.

(only on irrelevant reading: while he was inside, he moved the box.)

- (358) a. \*It was up that he looked t.  
b. \*It was in that he breathed oxygen t.  
c. \*It was on that he turned the TV t.  
d. \*It was inside that he moved the box t.

However, particles can be fragment answers.

- (359) a. (i) Did he look UP? — No, down.  
(ii) Where did he look? — Down.  
b. Do the aliens breathe xenon IN? — No, out.  
c. Did he turn the TV ON? — No, off.  
d. (i) Did he move the box INSIDE? — No, outside.  
(ii) Where did he move the box? — Inside.

---

accenting on the rest of the sentence. Answers are foci, and as such, I don't think that (i) constitutes an argument against the movement-plus-ellipsis analysis of fragment answers.

Not all particles can do this: the split seems to be that particles whose interpretation is transparent, as in (359), can be fragments, while particles whose interpretation forms a non-compositional idiom with their verb (e.g. *let off* = pardon, *let down* = disappoint, *take over* = come to control, *take out* = kill) cannot be fragments.

- (360) a. Did he let the criminal DOWN? — \*No, off.  
b. Did he take his business rivals OVER? — \*No, out.

These two classes (transparent and idiomatic) have been argued to show syntactic differences by Wurmbrand 2000. This seems to make a difference to whether or not the particles involved can be fragments; I will return to this in section 4.4. However, given that particles of either class cannot move in the presence of overt clausal syntax, it is unexpected on a movement analysis of fragments that cases like (359) should be possible.

### 4.3 Fragments and movement: the explananda

In the preceding section, we have seen that there are a number of challenges to Merchant 2004's arguments that movement is involved in the derivation of fragments, which are summarized below.

- Merchant claims that NPIs cannot be fragment answers (in English), and links this to the fact that they cannot front (in English). However, certain NPIs *can* in fact be fragment answers in English, although they are generally immobile.
- *The other* cannot move above *each* overtly, but *the other* is a licit fragment answer.
- Predicate fronting bleeds inverse scope relations, while predicate fragment answers allow inverse scope relations.
- Bare quantifiers cannot move in English, but can be fragments.
- Some particles and intransitive prepositions can be fragments, but particles/intransitive prepositions cannot move in English.

However, there is a lot of evidence in favor of movement. Much of this evidence (Case connectivity, the P-stranding generalization, etc.) was covered in chapter 2, and I will not repeat it here. However, I will briefly review one argument made by Merchant 2004. Recall examples of this form (repeated from (21)).

- (361) a. (Merchant 2004's (89), adapted)
- Did Abby vote for a *Green Party* candidate?
- (i) \*No, Reform Party. (= Reform Party ~~she voted for a t candidate~~)
- (ii) No, a Reform Party candidate. (= A Reform Party candidate ~~she voted for t~~)
- b. (Merchant's (137), adapted)
- What should I do with the spinach?
- (i) \*Wash. (= Wash ~~you should t it~~)
- (ii) Wash it. (= Wash it ~~you should t~~)

Nouns in noun-noun compounds, and verbs (to the exclusion of their complements), cannot undergo movement (at least not A'-movement). The fact that these elements also cannot be fragment answers suggests that we might want to argue that movement is indeed involved in the creation of fragments. Other examples which make the same point are repeated below from (23), (24).

- (362) VPs can move and finite TPs cannot:
- a. (He said he would make curry, and) [VP make curry] he should t.
- b. (John will make curry, and) \*[will make curry] Mary t, too.

- (363) VPs can be answers and finite TPs cannot:
- a. What will you do then? — Go to the beach ~~I will t~~.
- b. What will you do then? — \*Will go to the beach ~~I t~~.

Data of this kind strongly imply that movement *is* implicated in the creation of fragments. We appear to have a contradictory situation: by some diagnostics, fragments appear to move, while by other diagnostics, they do not. I propose below what I believe to be the key generalizations to take out of these diagnostics.

- (364) If a string cannot be targeted by a phrasal movement operation even in principle<sup>102</sup>, it cannot appear as a fragment.

This generalization covers the fact that non-constituents cannot be fragments, and the fact that heads (such as parts of compound words) cannot either. This generalization is a strong argument for a form of movement being implicated in the derivation of fragment answers in some way.

- (365) If a constituent is generally capable of movement, but is CONTEXTUALLY PREVENTED from moving in a given structure by dint of a structural configuration (such as, for example, being the complement of a P in non-P-stranding languages), it cannot appear as a fragment.

This formulation is intended to capture the inability to extract, for example, the complement of a P in non-P-stranding languages, or a TP which is complement to a C. These can be considered under the rubric of ‘locality effects’. For example, Abels 2003 argues that complements of P cannot be extracted in non-P-stranding languages because P is a phase head in these languages; extraction of P’s complement would have to proceed through [Spec, P] (to respect the ‘escape hatch’ property of phase heads), but this movement is too ‘short’, and is ruled out in these languages. Effects like this seem to block the availability

---

<sup>102</sup>‘Even in principle’ here means that the architecture of the grammar, as we understand it, does not allow the string to move, and that this is true cross-linguistically. The idea is to separate non-constituents and heads, which never undergo phrasal movement in any language, from things like particles or complements of PPs, which are immobile in certain languages, but mobile in others, suggesting that they are not immobile ‘in principle’.



of fragments. This generalization seems to suggest that movement *is* implicated in the derivation of fragments.<sup>103</sup>

(366) For certain INTERPRETIVE purposes such as *each...the other*, inverse scope effects in predicate fronting, and NPI licensing, fragments behave as if they are in their base position.

Movement bleeds *each...the other*, inverse scope in predicate fronting, and NPI licensing. However, in fragments, these bleeding effects do not obtain. In other words, fragments are generally *interpreted* in their base position, even in cases where overt movement prompts them to be interpreted in the position they are moved to. This suggests that – at least for purposes of interpretation – fragments do not move.

## **4.4 The solution: fragments move at PF, but stay in situ at LF**

### **4.4.1 Total reconstruction and movement at PF**

The last generalization just discussed provides, I believe, the key to the puzzle. As far as interpretation is concerned, fragments do not move. However, the restrictions on what can and cannot appear as fragments suggest that movement is indeed implicated. I suggest that this pattern tells us that fragments do undergo movement, but that this movement only takes place on the PF branch of the derivation. At LF, fragments stay *in situ*.

Consider NPI licensing, for example. While the precise conditions on NPI licensing are debated (whether the NPI has to be in a nonveridical environment, as argued by e.g. Giannakidou 2011, or in a downward-entailing environment, as Ladusaw 1979 argues), two things seem clear: NPIs must be in a particular *semantic* environment (downward

---

<sup>103</sup>The reader who is familiar with the literature on movement and ellipsis will have noticed that this formulation skirts the issue of the interaction of fragments with islands. This is because the data surrounding islands and fragments is very complex and has been the subject of much debate. In this section, I wish to put this contested issue aside and focus on generalizations which are more clearly empirically secure. I address this subject in more detail in section 4.5.

entailing or whatever), and this must hold on the surface. That is, (367a) is good but (367b) (in which the object is above negation at surface structure) is not (even though negation presumably takes semantic scope over the entire sentence).

- (367) a. John didn't eat any of the beans.  
b. ??Any of the beans, John didn't eat.

One way of understanding this is that the object has moved from a position below negation in (367b), and that every copy of an NPI must find itself in the correct environment. In (368), one copy of the object is not in the correct environment, and so is not licensed.

- (368) ??Any of the beans [John didn't eat any of the beans]

*Each...the other* cases can be considered the same way. If every copy of *the other* must be in the scope of an *each*, then that means that *the other* cannot be fronted past *each*; even though one copy remains in the scope of *each*, the highest copy is not.<sup>104</sup>

- (369) a. \*The other, each of them hates.  
b. [The other [each of them [hates the other]]]

Crucially, these are LF-level considerations, concerning binding (in the *each...the other* case) and downward-entailingness or nonveridicality (in the NPI-licensing case). If fragments are not interpreted at a high position at LF, the problems discussed above do not arise, and we predict that e.g. NPIs and *the other* can be good fragments.

---

<sup>104</sup>Maribel Romero (p.c.) asks why this sort of explanation does not also rule out cases where bound pronouns reconstruct to their base positions, as in (i).

- (i) His<sub>i</sub> mother, every Italian man<sub>i</sub> likes t.

I don't have an answer to why *the other* does not even have the *option* of reconstruction (i.e. non-interpretation in a high position), while bound pronouns like *his* do. The crucial point for me, however, is just the empirical fact that *the other* cannot be moved above its binder, but that this effect disappears under ellipsis.

There are a number of ways of implementing this basic idea. One idea, consistent with recent ‘single-output’ models of syntax, would hold that two copies are made of a moved fragment, but that different choices are made about how to interpret these two copies; the higher copy is interpreted at PF (only), and the lower copy is interpreted at LF (only).<sup>105</sup>

(370) a. What did John eat? — Chips ~~John~~ ate.

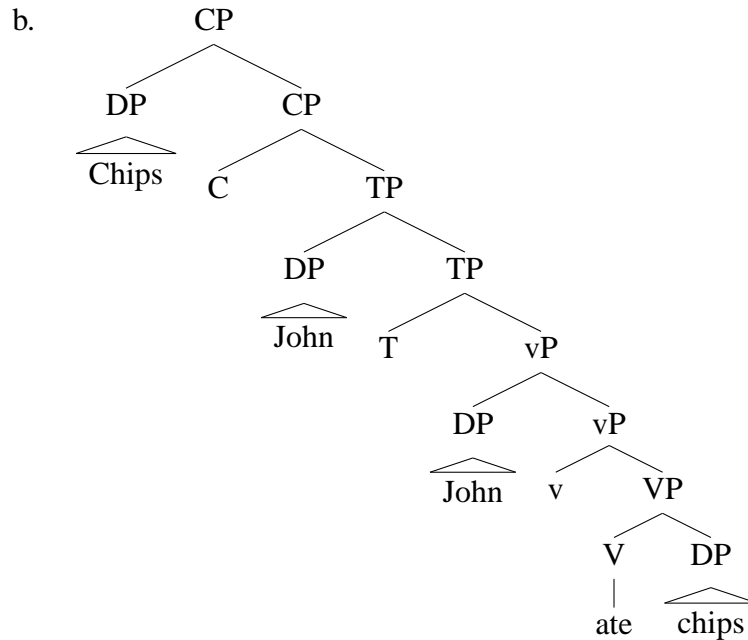

Higher copy of *chips* interpreted at PF; lower copy of *chips* interpreted at LF

I choose not to adopt this formulation here, however. One reason for this is that on such a view, it would essentially be a stipulation that the higher copy of the fragment is not interpreted at LF. On recent ‘single-output’ proposals for modeling movement, every part of a structure is input to interpretation.<sup>106</sup> The fact that certain elements, such as DPs which have undergone quantifier raising or *wh*-words, do not seem to be interpreted low, is handled via a mechanism which alters the interpretation of the lower copy(/ies) in a chain,

<sup>105</sup>In fact one could not tell if the lower copy was interpreted at PF, as it would be within an elided constituent and therefore deleted at PF for independent reasons.

<sup>106</sup>Further constraints are needed in order to ensure that only one copy (in the usual case) is interpreted at PF. See Nunes 2004 for discussion.

such as Fox's Trace Conversion mechanism (Fox 1999, 2002). This is illustrated briefly in the examples below (the reader is referred to Fox for the full details of the Trace Conversion procedure).

- (371) a. Which book did John read?
- (i) PF: Which book did John read ~~which book~~
- (ii) LF after Trace Conversion of the lower copy:  
Which book  $\lambda x$  [John read the book that is  $x$ ]
- b. John read every book.
- (i) PF: ~~every book~~ John read every book  
(Higher, QR'd copy of the DP not interpreted at PF)
- (ii) LF after Trace Conversion of the lower copy:  
Every book  $\lambda x$  [John read the book that is  $x$ ]

Given this general view of how the process of movement works in a single-output model, saying that high copies of fragments (and only fragments) are not interpreted at LF would be a stipulation. We do not want to say that, in general, everything which has moved can choose not to be interpreted (or to be interpreted through Trace Conversion) in a high position. If all kinds of moved copies can choose whether or not they are interpreted in a high position, we don't predict the badness of cases like (372).

- (372) a. ??Any of the beans, John didn't eat.
- b. \*The other, each of them hates.

If there is a process whereby copies of NPIs or *the other* can fail to be interpreted (or can be interpreted as their Trace-Converted variants) in high positions, then it's not clear what ends up ruling out the cases in (372). It would need to be said that these moved fragments can fail to be interpreted (i.e. would obligatorily reconstruct) just in case they move for ellipsis-related reasons. But it's not clear how ellipsis could feed obligatory reconstruction in this way, on a single-output model: if PF and LF are simultaneously interpreting one

single phrase marker with one single copy, how would LF ‘know’ to fail to interpret a higher fragment, just in case ellipsis was implicated in its having moved?

I propose an alternative formulation which derives the low interpretation of fragments without stipulation.<sup>107</sup> This approach is basically the one taken by Sauerland & Elbourne 2002 to facts similar to the ones discussed above, which they dub ‘total reconstruction’: cases in which a moved phrase can be ‘completely’ interpreted in its base position. Sauerland & Elbourne have in mind raising cases like the below.

(373) An Austrian is likely [t to win the gold medal].

A sentence like (373) can be interpreted with *likely* taking scope over *an Austrian* (i.e. the speaker does not have a particular Austrian in mind, but thinks that someone or other from Austria will win the gold medal). Sauerland & Elbourne point out that contexts like these license NPIs which appear to be above their licensors at surface structure, such as the below.

(374) A doctor with any reputation [is likely not to be [t available]]

But crucially in such cases the *interpretation* of the phrase *a doctor with any reputation* has to be in its base position, below *likely*; that is, (374) cannot be talking about a specific doctor.

On this basis of this and other evidence, Sauerland & Elbourne argue that phrases which undergo ‘total reconstruction’ (such as *a doctor with any reputation* in (374)) have undergone PF-movement to their pronounced position, but at LF, are interpreted as if they have not moved. They argue that such cases argue for a derivational, ‘Y-model’ theory of syn-

---

<sup>107</sup>I do not mean to suggest that *no possible* version of the single-output model can derive the facts presented here. It is possible that further research and development of a single-output model of syntax will discover a principled reason why copies of *the other* or NPIs need not be interpreted in their high positions in fragment movement, but must be interpreted there (leading to ungrammaticality) in e.g. topicalization. See section 5 of Sauerland & Elbourne 2002 for some discussion. However, pending discovery of such a reason, I adopt the Y-model formulation given here.

tactic structure; a model in which operations in the ‘narrow syntax’ take place before a branching point, at which the derivation is sent off to PF and LF.

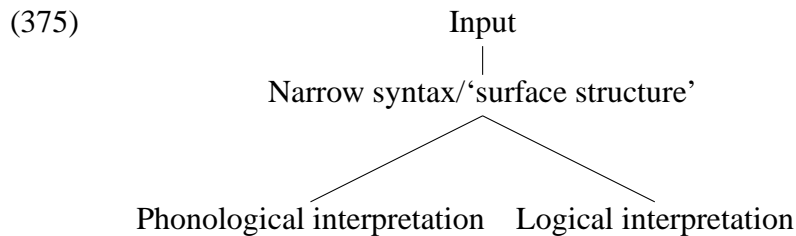

A movement that happens only at PF, but not at narrow syntax or LF, does not affect interpretation.

I assume, along with Sauerland & Elbourne 2002, that the movement operations which are available along each branch (PF/LF) are fundamentally the same operations which are available at narrow syntax. In particular, I assume that the set of things which movement operates over remains the same – that is, essentially, movement continues to target syntactically defined constituents rather than, say, linearly continuous substrings, or syllable sequences, or things of that sort.<sup>108</sup> After ‘narrow syntax’, further syntactic operations can take place along both the PF and LF branches of the tree, but these two levels of PF and LF do not ‘communicate’ with each other after the branching point, and operations that are performed along one ‘branch’ have no effect on the interpretation given to the syntactic structure on the other ‘branch’.

Given this, I propose that the syntax of a fragment answer structure at the point at which the derivation branches into PF and LF resembles the below. (I simplify slightly by collapsing vP and VP into a single phrase.)

---

<sup>108</sup>There may be displacement procedures which take place in the phonology ‘proper’ and derivationally ‘after’ the PF movement I envisage here, that is, movements which genuinely do operate on substrings; some approaches to clitic placement, for example. All I rely on here is the availability of a certain stage in the derivation where operations on phrase markers have an effect, but only at PF.

(376) a. What did John eat? — Chips.

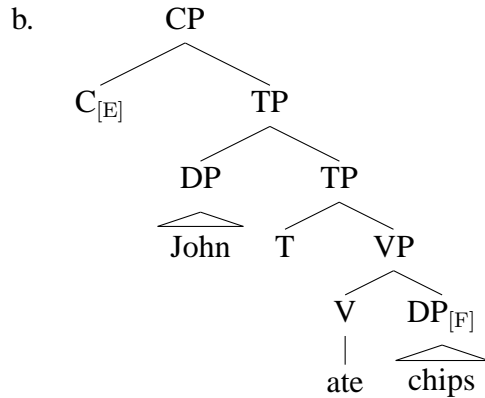

At this point, the DP *chips* is *in situ* and is endowed with a [F(ocus)] feature. The complementizer<sup>109</sup> bears the [E]-feature, which licenses ellipsis, following Merchant 2001, 2004.

At this point neither of these features is doing any syntactic work. However, after the structure is sent off to LF and PF, these features start to interact. I propose that no further transformations take place along the LF branch.<sup>110</sup> That is, the LF of a fragment structure looks just like (376b). However, at PF, I propose that the [F]-marked DP does move.

Specifically, I follow a suggestion made by Yoshida et al. 2013 for *why*-stripping cases (such as *John ate natto. Why natto?*). Their proposal builds on the notion of a Recoverability condition of the sort proposed by Pesetsky 1997. The essence of the condition is this. The [E] feature instructs the phonology to delete/fail to realize all the material that should be linearized in its TP complement. However, part of that material – the DP *chips*, in this case – is marked with a [F]-feature. The phonological interpretation of this feature is a pitch accent and stress. However, the requirement to stress the DP is at odds with the requirement that the material within TP not be pronounced. I propose that the way the grammar resolves this conundrum is to allow PF to carry out a ‘last resort’ movement of

---

<sup>109</sup>I defer discussion of the precise nature of the head that bears the [E]-feature until chapter 5.

<sup>110</sup>At least, not ones relevant for the derivation of the ellipsis in the structure. Other transformations which occur at LF, such as quantifier raising, may still take place.

an [F]-marked constituent to a position outside of the ellipsis, the specifier position of the head bearing the [E]-feature.

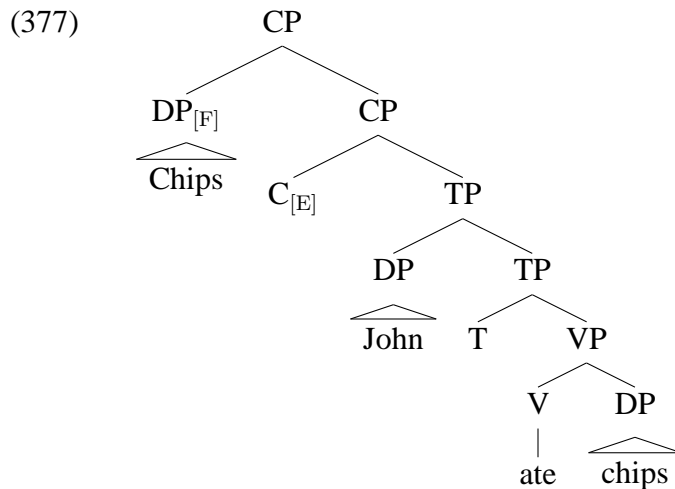

This is a syntactic process. It targets constituents, not substrings. It only targets constituents which can in principle be moved (on which, see below). And it can in principle allow pied-piping, allowing for alternations such as the below.<sup>111</sup>

- (378)
- a. To whom did you give the book? — John./To John.
  - b. [CP John [TP I gave the book to t]]
  - c. [CP To John [TP I gave the book t]]

In fact, in some cases pied-piping is obligatory, just as it would be in full clauses; for example, if the focused phrase would otherwise undergo a left-branch extraction.<sup>112</sup>

- (379) How many students were asleep?
- a. [F Every] student.
  - b. \*[F Every].

---

<sup>111</sup>I will remain agnostic here about whether pied-piping is to be understood as being a case of ‘percolation’ of focus marking to a higher constituent, or as taking place via some other mechanism; see Heck 2009, Cable 2012 for some recent discussion.

<sup>112</sup>This assumes that ellipsis cannot ‘rescue’ ungrammatical cases of left-branch extraction in English, contra Kennedy & Merchant 2000, Merchant 2001, but in line with Barros et al. to appear. I discuss this in more detail in section 4.5.



- c. [CP every student [~~TP t was asleep~~]]
- d. \*[CP every [~~TP~~ [~~DP t student~~] was asleep]]

(380) Which students did you talk to?

- a. The [<sub>F</sub> German] students.
- b. \*[[<sub>F</sub> German].
- c. [CP the German students [~~TP I talked to t~~]]
- d. \*[CP German [~~TP I talked to~~ [~~DP the t students~~]]]

#### 4.4.2 Exceptional movement

I claim that this movement is indeed syntactic, although it takes place on the PF ‘branch’ of syntax. However, I argue that it is not driven by feature-checking. It is driven entirely by the need of PF to reconcile the instruction to elide TP with the instruction to stress anything which is focus-marked. The only way PF can do this is by extracting a constituent which is focused – plus any material which it might need to pied-pipe – to a position outside of the elided clause.

The last-resort nature of this process has the effect of restricting the movement to co-occurring with ellipsis only. The ability of ellipsis to prompt so-called ‘exceptional movement’ is well known. It has been discussed for fragment answers and pseudogapping (Takahashi 2004, Fox & Pesetsky 2005); as discussed above, Yoshida et al. 2013 extend it to *why*-stripping, as does Weir to appear; and Sailor & Thoms 2014 extend it also to so-called non-constituent coordination cases (like *I talked to John on Wednesday and Mary on Thursday*), which they analyze as involving ellipsis. Exceptional movement, as the name suggests, is a type of movement which occurs only in ellipsis; casting it as a ‘last resort’ PF phenomenon, as is done above, lets us understand why it might be exceptional. It also helps us understand a property of exceptional movement noted by Boone 2013: it only ever moves a constituent to the immediate left of an ellipsis site, no further. That is, pseudo-

gapping or fragment answers like those in (381) are grammatical, but those in (382) are not.

- (381) a. I eat curry more often than I do [<sub>FP</sub> noodles [<sub>VP</sub> eat t]]  
 b. What did John eat? — Mary thinks [<sub>CP</sub> the cookies [<sub>TP</sub> John ate t]].
- (382) a. \*I eat curry more often than I noodles do eat t.  
 b. What did John eat? — \*Mary noodles thinks that John ate t

Of course the movements in (382) are not licit outside of elliptical contexts, but the point is that neither are those in (381). Exceptional movement is allowed in cases of ellipsis, as (381) shows, but it can only go so far.<sup>113</sup> Boone 2013 offers an explanation of these facts in terms of Fox & Pesetsky 2005's Cyclic Linearization proposals (see also Takahashi 2004 for pseudogapping): exceptional movement is a countercyclic movement which creates an inconsistent linearization of terminals. This inconsistency can be repaired if all the material to the right of the moved fragment is deleted by ellipsis, but not if any such material remains. As such, exceptional movement can only move phrases to the immediate left of an ellipsis site, and no further.<sup>114</sup> While I won't review cyclic linearization accounts in

---

<sup>113</sup>This only applies to *exceptional* movement. If there are independent movement processes which can move something out of an ellipsis site, they can move to a position further to the left of the ellipsis site. So, for example, in embedded fragments in some dialects of Dutch, the fragment can appear to the left of the embedding verb (Temmerman 2013b):

- (i) Wie dacht je dat de nieuwe directeur zou worden?  
 who thought you that the new director would become?  
 'Who did you think would become the new director?'  
 a. Ik had gedacht Tom.  
 I had thought Tom  
 b. %Ik had Tom gedacht.  
 I had Tom thought

But this is because the movement in (ib) is possible even in non-elliptical contexts for these speakers.

- (ii) %Ik had Tom gedacht dat de nieuwe directeur zou worden.  
 I had Tom thought that the new director would become

<sup>114</sup>This also bears resemblance to Thoms 2010's movement-based theory of ellipsis licensing.

detail here, we can see that the PF-only ‘last resort’ movement analysis proposed here bears a family resemblance to them, and accounts also for the fact that such movements are ‘exceptional’ in the sense that they only take place in elliptical constructions.

This view is at odds with the analysis proposed in Merchant 2004, in which the [E]-feature itself can attract and check the [F]-feature on the focused constituent to escape the ellipsis. It is also at odds with the analysis proposed in Richards 1997, 2001, adopted and extended by Temmerman 2013b, in which an [F]-feature is weak in English. On this proposal, a focused constituent can in principle move at narrow syntax in English. However, Richards argues that the focused constituent has only a weak feature. Richards argues that at the PF interface, if two copies of a phrase are present, PF chooses which one to pronounce based on the presence of a strong feature; so for example *wh*-phrases are pronounced at the left periphery in English because they have checked a strong feature in that position, while the copy left downstairs does not. However, if focus features are weak in English, PF will not receive unambiguous instructions about which copy of the focused constituent to pronounce; the derivation will then crash at PF.

(383) [FP Chips<sub>[Foc]</sub> [TP he ate chips<sub>[Foc]</sub>]]

High and low copies both have weak features: PF does not know which to pronounce, derivation crashes

If, however, the downstairs copy of the focused constituent is deleted by dint of being inside an ellipsis site, PF does receive unambiguous instructions about which copy to pronounce (it can only pronounce the upstairs copy).

(384) [FP Chips<sub>[Foc]</sub> [~~TP he ate chips<sub>[Foc]</sub>~~]]

High and low copies both have weak features, but the lower copy is in an ellipsis site, so PF knows which one to pronounce and derivation converges

One issue with this solution is that it seems to predict that any form of deletion should be able to license focus movement. This does not seem to be the case, however; verb phrase ellipsis, for example, does not license focus movement to the edge of the clause.

(385) No no, it wasn't chips I ate. \*COOKIES I did ~~eat cookies~~.

However, this might be independently ruled out by the constraint requiring ellipsis of 'as much as possible' if an ellipsis site contains a variable (MaxElide: Takahashi & Fox 2005, Merchant 2008, Hartman 2011). In addition, it may be the case that there are intermediate landing sites in (385) which are not deleted by VPE, e.g.

(386) [<sub>FP</sub> Cookies [<sub>TP</sub> I did [<sub>VP</sub> cookies [<sub>VP</sub> ~~eat cookies~~]]]]

So there would still be an intermediate copy of *cookies* with a weak feature, which is not deleted by ellipsis; so there would not be unambiguous instructions to PF about which copy of *cookies* to pronounce.

I think that the true counterargument against this sort of proposal is that, if focus movement is in general an option available to English (but is precluded in non-elliptical constructions for PF reasons), we do not have an understanding of why the fragment should not be interpreted in its high position. If the putative focus movement in fragments is feature-driven A'-movement, just like *wh*-movement and topicalization, then it should pattern for interpretive purposes just like those movements. However, it doesn't, as we have seen above; NPI licensing, *each...the other* binding, and inverse scope in predicate fronting are all bled under topicalization, but not by fragments.<sup>115</sup>

---

<sup>115</sup>Note that we couldn't argue that focus generally gets interpreted in its base position. Clefting, which is a focus construction, bleeds NPI licensing and *each...the other* in the same way as topicalization does (and fragments do not):

- (i) a. \*It's any of the natto that he didn't eat.
- b. ??It's the other that each of them hates.

By contrast, on a proposal in which focus movement is not generally available in English, but is forced at PF only in elliptical constructions ('ellipsis feeds (forces) PF-movement'), we understand why this should be. The movement is taking place only at PF, to serve the needs of PF. It is not interpreted at LF, explaining the patterns which we see.

#### 4.4.3 Is it really movement?

Having established this, we might wonder if we have evidence for movement at all in fragments. Why talk of movement at PF (a contested notion), as opposed to simply saying that fragments do not move, and focused constituents within ellipsis sites can be pronounced?

The main reason for this is the correlation between phrases which can A'-move and phrases which can be fragments. This is not merely a categorial restriction (i.e. of the form 'heads cannot A'-move and also cannot be fragments'). If this were so, we might try looking for a common reason why certain constituents could not move and also could not be fragments. On some theories, for example, only phases can move (as suggested by e.g. Chomsky 2008:14). If it were also (independently) true that only phases could be fragments (for example), then we would have a common explanation for the correlation, and we would not have evidence for movement being involved in the derivation of fragments.

However, in many cases certain constituents can move *in principle*, but a certain structural configuration blocks them from moving. P-stranding effects are of this type, for example (illustrated below for French).

- (387) a. Quel étudiant as-tu vu t?  
          which student have-you seen
- b. Avec quel étudiant as-tu parlé t?  
          with which student have-you spoken
- c. \*Quel étudiant as-tu parlé avec t?  
          which student have-you spoken with

As can be seen from (387a), the DP *quel étudiant* ‘which student’ is capable of movement in general. However, it cannot move when it is a complement of a P (see Abels 2003 for one influential analysis of this fact). And in these structures, such DPs also cannot be ellipsis remnants (Merchant 2001’s P-stranding generalization). A number of other such cases have been discussed in section 2.2.2. It is these cases which are crucial to the argument that movement is involved in the derivation of fragments. It is not clear how to derive the fact that some phrases are not licit fragments just in case their correlates in an antecedent are in a particular (movement-forbidding) structural configuration, without saying that fragments are created by movement in the way discussed by Merchant 2004.

Given such facts, I argue that an analysis of fragments in which they move – following all the standard syntactic restrictions on movement, such that for example P-stranding violations are not countenanced in languages where this is impossible – but in which this movement only takes place at PF, can best account for the properties of fragments. Fragments are created by movement: facts like the P-stranding generalization show us that. However, this movement is ‘exceptional’ (in the sense that it does not take place outside of elliptical constructions), and it does not seem to be interpreted at LF. Movement at PF only, in order to move a focused constituent out of an ellipsis site, fits these facts.

This analysis suggests that the failure of particles to move (in non-elliptical structures), and the failure of bare quantifier phrases to front (in non-elliptical structures), is an LF problem, on a par with NPI licensing, inverse scope readings, and *each...the other* licensing.

- (388) a. \*Off, he turned the TV.  
 b. \*Everyone, he saw.
- (389) a. Did he turn the TV ON? — No, OFF.  
 b. Who did he see? — Everyone.

Because particles and bare quantifier phrases are licit fragments, and because I argue that fragments are bona fide cases of movement (although movement which is not interpreted at PF), the current analysis forces us to conclude that the problem in (388) is one of interpretation at LF. The reason particles and bare quantifiers can be fragments is because ellipsis is the only environment in which left-peripheral movement can take place and not be interpreted (i.e. the movement can take place only at PF).

Without a secure understanding of why particles and bare quantifiers do not move in non-elliptical structures<sup>116</sup>, I cannot evaluate whether cases like (388), (389) constitute problems for the present analysis. I would suggest that, given the advantages of the PF-only movement approach to fragments, we seek an LF-level reason for the failure of cases like (388). For the bare quantifier case, we might seek an explanation in their status as operators, as in Cinque 1995:ch. 3; but exploring this in detail is outside the scope of this work.

A last note on particles: recall that not all cases of particles could be good fragments, as (390) shows.

- (390) a. Did he let the criminal DOWN? — \*No, off.  
b. Did he take his business rivals OVER? — \*No, out.

The particles which are not good fragments are those which have idiomatic interpretations in combination with their verbs, as discussed in section 4.2.5. This follows quite nicely from Wurmbrand 2000's proposal that in idiomatic cases like *let someone down*, *let someone off*, *take something over*, *take someone out*, the particles are syntactically heads which combine with V<sup>0</sup>s, while in the 'transparent', compositional cases like *take the trash out*, *turn the TV off*, the particles are PPs which form small clauses with the DP object. Heads

---

<sup>116</sup>The issue is particularly mysterious given that particles can move (in non-elliptical structures) in German, for example, as discussed below. This would suggest that the problem is not merely with information structure (e.g. particles can't be topicalized/focused, and so can't be fronted), as they can be fronted in German. I will not have anything further to say here about the etiology of the apparently English-specific ban on particle fronting.

don't undergo A'-movement, so on a Merchant 2004-style movement analysis of fragments, we don't expect the 'idiomatic' particles to be possible fragments. By contrast, PPs can unproblematically be fragments, so if 'transparent' particles are phrasal, we expect them to be fragments too (even though even these transparent particle cases do not seem to be mobile outside of elliptical cases in English, for unclear reasons). This is just what the data show. It is bolstered further from the fact, reported by Wurmbrand 2000, that the 'transparent' particles in fact can front in German, but 'idiomatic' ones cannot:<sup>117</sup>

(391) (Wurmbrand's (12))

- a. Auf hat er die Tür t gemacht  
open has he the door made  
'He opened the door' (*aufmachen* = to make open, transparent)
- b. Weg hat er den Brief t geschickt  
away has he the letter sent  
'He sent away/off the letter'
- c. \*Auf haben sie das Stück t geführt  
PRT have they the piece performed  
'They performed the piece' (*aufführen* = to perform, lit. 'to act out', idiomatic)
- d. \*Auf hat sie die Suppe t gegessen  
PRT has she the soup eaten

---

<sup>117</sup>Putting this down to a syntactic difference is not the complexion that Wurmbrand puts on these facts. She argues that, because idiomatic particles do not contribute meaning of their own, they cannot be put in a contrastive relationship, and so cannot be topicalized or focalized. It's not completely clear to me that this is true, at least going by prosody: in an example like the below, it seems possible to put two particles in a contrastive relationship, as indicated by stress placement. (*over* receives a B-accent/rise-fall-rise contour, *out* receives an A-accent/falling tone.)

- (i) He doesn't take his business rivals OVER, he takes them OUT.

Even if Wurmbrand's explanation were right, it's not clear to me that it could extend to the fragment cases (given that I am claiming that fragments do not undergo an *interpreted* movement). However, the contrast in the grammaticality of movement between the two sets of particles is the main issue of interest here, whatever explanation is eventually found for it.



‘She ate up the soup’ (*aufessen* = to eat up, lit. ‘to eat out’, idiomatic)

The fact that particles which are mobile (at least in principle, as the German data in (391) show) can be fragments, but particles which are immobile cannot be, lends further support to the notion that movement is involved in the creation of fragments.

#### 4.4.4 Movement and economy

We want to understand why focus movement in English is restricted to the PF side of the derivation. We have evidence that this is the case, because exceptional movement of a fragment is not interpreted at LF, but it isn’t clear why that rules out this movement at narrow syntax. Above, I referred to focus movement as a ‘last resort’ condition, which is not feature-driven, but this is not a full answer: we still want to understand why the relevant movement – which does appear to be syntactic in nature – cannot take place at narrow syntax. We also want to understand why a Last Resort movement is prompted at all. Other alternatives to moving focused material out of an ellipsis site are imaginable. For example, one could imagine that the presence of focused material within the ellipsis site simply blocks ellipsis. If this were true, this would predict that we would simply never see fragments.

I first present a way of thinking about the economy problem, drawing on the idea of Economy of Derivation (Chomsky 1995 and much subsequent work); movements are barred unless there is a reason to do them. One reason may be to check strong features – this is the standard explanation for A’-movement in the narrow syntax. Another reason might be to generate a particular interpretation: for example, quantifier raising at LF. Another reason might be for prosodic/recoverability reasons of the type discussed above: material which has to be stressed cannot remain within an ellipsis site, and has to be moved out of it.

With this in place, we can imagine that a derivation proceeds like this. There are two ‘tracks’ of a derivation, PF and LF, and these both run concurrently.<sup>118</sup> A derivation  $\alpha$  is more economical than another  $\beta$  if  $\alpha$  involves fewer movement operations on both tracks. A strong feature is one that must be checked on both tracks. A weak feature is one that only needs to be checked on the LF track. Because it would be a violation of economy to check a weak feature on the PF track as well, such checking does not happen, and phrases with weak features do not move at PF.

I assume that there is no feature which drives focus movement in English, whether a strong or a weak feature. There is therefore no requirement to do focus movement at LF; and by economy, such movement therefore *cannot* happen at LF. However, in elliptical constructions, focus movement is required to take place at PF, to satisfy a need on the PF side. This is a way of cashing out the intuition that exceptional movement in ellipsis takes place ‘to satisfy the needs of PF’: it is a movement that takes place only on the PF track. If it took place in ‘narrow syntax’ (that is, at both PF and LF), it would violate Economy; it has no reason to move at LF, and so such a derivation would be less economical than one in which the fragment moved at PF only.

In this way, focus movement only takes place on the PF ‘track’, not at both LF and PF. This gives us a handle on why the movement which creates fragments, which is indeed a syntactic movement, does not have interpretive effects: it takes place at PF due to a requirement to move focused phrases out of the domain of ellipsis, but there is nothing driving this movement at LF, so fragments stay *in situ* at LF.

As for the question of why ellipsis is allowed to happen at all – why it is not simply blocked by the presence of focused material inside the ellipsis site – I propose to think of it this way. We could imagine both the pressure against movement – Economy of Derivation – and the pressure to elide a constituent whose sister is marked with the [E] feature as

---

<sup>118</sup>I thank Kyle Johnson for suggesting the outlines of this solution to me.

constraints of a sort.<sup>119</sup> The difference I would appeal to is that the constraint against movement is violable in the correct configuration. We know this must be the case, because we do observe movement; what constrains movement is that it must happen ‘as little as possible’ consistent with achieving other goals of the derivation (generally conceived of in Minimalism as interpretability at the PF and LF interfaces).

By contrast, I suggest that the ‘constraint’ which the [E] feature imposes on its sister (that it not be pronounced) is not violable. The sort of analogy I have in mind is that features which determine the morphophonological spellout of an item – which is what the [E] feature is, on the view of Merchant 2001 – do not generally change depending on context. For example, the [+Q] complementizer in English is pronounced *if* (or *whether*), but never as *that*, regardless of environment. That is, the constraint or rule that says ‘spell out a [+Q] complementizer as *if*’ is not a violable one. I argue that the phonological effect of the [E] feature is the same; if a structure contains an [E] feature, then the complement of that [E] feature must be silent at spellout; there cannot be exceptions or violations.

Similarly, the ‘constraint’ that focused phrases must be pronounced is of a similar type: it is ungrammatical to fail to pronounce (or to fail to give pitch accent to) a focused phrase, and this constraint seems to be completely inviolable. As far as I am aware, there are no cases in which constituents which represent new information can fail to receive the pitch accent characteristic of focus marking<sup>120</sup>; such constituents cannot, for example, be deaccented, and one might suppose that *a fortiori* they cannot be elided.

The upshot is that if the grammar constructs a sentence which contains [E] in its numeration, but in which the complement of [E] contains a focused phrase, there is a conflict: the

---

<sup>119</sup>I am talking somewhat metaphorically here. I do not mean to suggest that we are ‘really’ dealing here with constraints (as in e.g. the \*MOVE constraint in OT syntax), or that our model of grammar should be constraint-based (I remain agnostic on this issue); I just rely on this formulation to get the leading idea across here.

<sup>120</sup>Modulo cases of ‘second occurrence focus’ such as those described in Partee 1991, 1999; these don’t get pitch accent, but even in such cases, recent work (Beaver et al. 2007, among others) has argued that some sort of accenting is realized by the phonology, although this is controversial.

focused phrase needs to be pronounced, but the complement of [E] needs to be silent. One logically possible way of resolving this conflict would be to override the requirement that [E]’s complement be silenced – to simply not do ellipsis – but as I argue above, I suggest that this is not actually possible; the requirement that the complement of [E] be silent is inviolable. If a derivation contains the [E] feature, then ellipsis is obligatory. Similarly, it would be logically possible simply not to pronounce the focused phrase, but this is also actually impossible, as discussed above. The solution is movement. It would be preferable, due to economy considerations, not to move the focused phrase (and so this movement does not happen outside of elliptical contexts); but when this is the only way of fixing a conflict, then movement happens. This movement does represent a violation of Economy of Derivation, but an acceptable one, as no other derivation can ‘solve’ the problem of having an F-marked constituent within a subtree marked for non-pronunciation by the [E] feature. Economy is, however, respected as much as possible, in as much as the movement takes place at PF only (as the ‘violation’ that it is ‘fixing’ is only a problem at PF, not LF). This explains why the movement is not semantically interpreted (i.e. the movement does not take place at LF).

To spell out the assumptions here more clearly, I assume that in an elliptical construction, the [E] feature is present in the numeration – the unstructured set of lexical items to which the structure-building operation Merge is applied (Chomsky 1995 et seq.) In non-elliptical configurations, the [E]-feature is not in the numeration. The choice of items in the numeration is ‘free’ – that is, both of the numerations (392a), (393a) are available to the grammar (when constructing a sentence which answers e.g. *Who ate the cake?*). However, this choice has implications for the phrase marker, and linear string, which is the eventual output of the grammar, shown in (b, c).

(392) a. {C<sub>[E]</sub>, T<sub>[past]</sub>, John<sub>[Foc]</sub>, eat, the, cake}

b. Phrase marker as sent to PF interface (simplified):

[<sub>CP</sub> [<sub>DP</sub> John<sub>[Foc]</sub>] C<sub>[E]</sub> [<sub>TP</sub> T<sub>[past]</sub> [<sub>DP</sub> John<sub>[Foc]</sub>] [<sub>VP</sub> [<sub>V</sub> eat] [<sub>DP</sub> the cake]]]]

- c. Linear string: *John*
- (393)
- a. {C, T<sub>[past]</sub>, John<sub>[Foc]</sub>, eat, the, cake}
  - b. Phrase marker as sent to PF interface (simplified):  

$$[CP\ C\ [TP\ T_{[past]}\ [DP\ John_{[Foc]}\ [VP\ [v\ eat]\ [DP\ the\ cake]]]]]$$
  - c. Linear string: *John ate the cake*

The first of these numerations will result in the linear string *John* (with ellipsis); the second will result in the string *John ate the cake*, a non-elliptical string. Importantly, I am not assuming that these two numerations and their associated derivations are in competition with each other. If they were, we might assume that (393) would always be the successful derivation, as it is the most economical (there is no pressure to perform ellipsis and therefore no focus movement). Rather, for any given derivation, economy is calculated only with respect to the numeration in that derivation.<sup>121</sup>

That is, (392) is a possible numeration, and a combination of economy conditions and the fact that the [E] feature obligatorily elides its complement will dictate that the only possible outcome of the derivation is one with PF-level focus movement and ellipsis – that is, the string *John*. The fact that (393) is another possible numeration which expresses the same meaning (but which would be more economical) is not relevant for the computation of the derivation in (392); the grammar’s ‘job’, when faced with (392), is to construct the most economical derivation it can given those words (and the inviolable constraint that [E] silences its complement). That derivation is one which contains focus movement (to get a focused phrase out of an ellipsis site), even though this movement violates Economy of Derivation.

---

<sup>121</sup>I am not suggesting that transderivational constraints play no role in the grammar at all; there may well be cases where one derivation is favored over another. Indeed the ‘no-new-words’ constraint discussed in section 3.7 is a transderivational one. I am only arguing that this is not the case for the syntactic considerations at play here.

This analysis aims to capture the fact that ellipsis is optional (that is, there is a choice about whether the numeration contains the [E] feature or not), but if the [E] feature is in the numeration, then this prompts obligatory focus movement at PF; while this movement violates economy considerations (as all movement operations do), it is the only way to ensure that a focused phrase escapes an ellipsis site, while still preserving the obligatory nature of the ellipsis of [E]’s complement.

If this sort of PF-only movement happens in elliptical constructions, we might ask what interaction it has with islands, and whether clausal ellipsis can rescue island violations; in the next section, I will consider this question.

## 4.5 Islands

If fragments could be shown to be sensitive to syntactic islands, this would be a good piece of evidence in favor of a movement analysis of fragments. Merchant 2004 does indeed argue that fragments show island sensitivity. That is, if the correlate of a fragment in an antecedent sentence is inside an island, the fragment is ungrammatical.

This is difficult to show directly, as the questions required as antecedents for such fragment answers would themselves involve movement of a *wh*-word out of an island, and would be ungrammatical.

(394) \*Who does Abby speak the same Balkan language (that) t speaks?

To circumvent this problem, Merchant uses a technique attributed to Morgan 1973. A polar question can be understood as an implicit constituent question if a rising intonation is placed on the constituent being questioned, as (395) shows. (I show the rising intonation by placing a ↗ before the constituent where the rise is placed.)

(395) (Merchant’s (84))

- a. Does Abby speak ↗[Greek] fluently?
- b. No, she speaks *Albanian* fluently.

- c. No, *Albanian*.

If such a rise is placed on a constituent inside an island, as in (396a), the full clausal answer is acceptable. However, the fragment answer (Merchant claims) is not.

- (396) (Merchant's (87), slightly adapted; his judgments)
- a. Does Abby speak the same Balkan language that  $\nearrow$ [Ben] speaks?
  - b. No, she speaks the same Balkan language that *Charlie* speaks.
  - c. \*No, *Charlie*.

Similar examples can be adduced for other cases in which the correlate of the fragment answer is inside an island:

- (397) (Merchant's (88, 89, 90); his judgments)
- a. Did Ben leave the party because  $\nearrow$ [Abby] wouldn't dance with him?  
\*No, *Beth*. (adjunct island)
  - b. Did Abby get  $\nearrow$ ['The Cat in the Hat'] and 'Goodnight Gorilla' for her nephew for his birthday? (coordinate structure)  
\*No, 'The Lorax'. (intended: 'No, Abby got 'The Lorax' and 'Goodnight Gorilla' for her nephew for his birthday.')

Merchant argues that the movement-plus-ellipsis account of fragment answers accounts for this contrast. In an elliptical sentence like (398a), the fragment has not moved from an island and so is licit. However, in an elliptical sentence like (398b), the fragment would have moved from an island; the resultant violation rules out the fragment.

- (398) a. Did Abby claim she speaks  $\nearrow$ [Greek] fluently?  
No, Albanian [~~she claimed she speaks t fluently~~]
- b. Does Abby speak the same Balkan language that  $\nearrow$ [Ben] speaks?  
\*No, Charlie [~~she speaks the same Balkan language that t speaks~~]

One issue Merchant has to tackle is that sluicing, which Merchant analyzes as the same form of TP ellipsis as fragment answers (Merchant 2001), in fact does *not* seem to show the same sort of island sensitivity, as first noted by Ross 1969. That is, sluicing versions of sentences similar to the above examples are grammatical, even though the putative elliptical sources contain island violations.

- (399) a. Abby speaks the same Balkan language that someone (in this room) speaks, but I'm not sure who ~~she speaks the same language that t speaks~~.
- b. Ben left the party because someone wouldn't dance with him, but I'm not sure who ~~Ben left the party because t wouldn't dance with him~~.

Merchant accounts for this by adopting a version of the PF theory of islands, and suggesting that the movements involved in generating sluices allow ellipsis to 'void' island violations in a way that the movements involved in generating fragment answers do not. I refer the reader to Merchant 2004 for the full details.

However, the empirical facts concerning island sensitivity in fragments have been the subject of debate. Stainton 2006b has already pointed out that there appear to be certain techniques for circumventing the apparent island-sensitivity. One of these ways is to use a special register of English which leaves *wh*-words in situ; this is a register which is used in quiz show programs, for example.

(400) (Stainton 2006b:p. 138, adapted)

Q: The Pope's favorite cocktail is made of beer and what other ingredient?

A: Tomato juice.

Note that the correlate of the fragment answer in the question, 'what other ingredient', is here within a coordination structure and is so immobile. A variant of this question in which the *wh*-word is extracted would be ungrammatical: *\*What ingredient is the Pope's favorite cocktail made of beer and t?* On the movement analysis of fragments, the answer *tomato juice* should therefore also be ungrammatical: the predicted structure would be



[Tomato juice ~~[the Pope's favorite cocktail is made of beer and t]~~], which contains an island violation. Similar amelioration by the use of *wh*-in-situ 'quiz show English' can be shown for other islands:

- (401) a. Q: Abby speaks the same Balkan language that which other member of her family speaks?<sup>122</sup>  
A: Ben.
- b. Q: Ben left the party because which member of the church council refused to dance with him?  
A: Abby.

And, in a similar vein, if the correlate of the fragment in the antecedent is an indefinite, the sentences are again grammatical with no hint of island violation (this fact is noted in Griffiths & Lipták 2014):

- (402) a. A: The Pope's favorite cocktail is made of beer and something else.  
B: Tomato juice.
- b. A: Abby speaks the same Balkan language that someone (in this room) speaks.  
B: (Yes,) Ben.
- c. A: Ben left the party because someone refused to dance with him.  
B: (Yes,) Abby.

I would add that there are some examples, in which the correlate of the fragment is inside an island, where fragment answers do not sound so bad even using the 'implied constituent question' technique. Griffiths & Lipták 2014 and Barros et al. to appear report similar results.

---

<sup>122</sup>For some reason, possibly related to the facts noted in Pesetsky 1987, leaving *wh*-words in situ in this register is rather easier for *which NP* constructions than 'bare' *wh*-words such as *who* or *what*. I therefore change the foregoing examples to this extent.

- (403) a. Q: Do they grant scholarships to students that study ↗[Spanish]?  
 A: No, French. (relative clause)
- b. Q: Do you take milk and ↗[honey] in your tea?  
 A: No, sugar. (coordinate structure)

In addition to this data, Griffiths & Lipták 2014 have argued that *contrastive* fragment answers (ones where the fragment contrasts with a focused correlate in the antecedent) are island-sensitive, while non-contrastive fragments (where the correlate in the antecedent is an indefinite) are island-insensitive. The below are their (44, 49), slightly adapted.

(404) A: I hear that Abby is likely to get mad if one of the guys from your syntax class speaks to Mary.

B: Yeah, Bill. (non-contrastive fragment)

(405) A: I hear that Abby is likely to get mad if BEN speaks to Mary.

B: \*/#No, Bill. (contrastive fragment)

The same facts hold for sluicing, as Merchant 2008 notes (his (52b)):

(406) \*The radio played a song that RINGO wrote, but I don't know who else ~~the radio~~  
~~played a song that t wrote.~~

How to make sense of this data? One tack, already discussed in section 3.7, first suggested by Pollman 1975, Erteschik-Shir 1977 and recently taken up by Barros et al. to appear, has been to suggest that in many of the acceptable cases of apparent island violations, in fact the elided sentence is not the full antecedent, but rather an alternative source such as a cleft. On this view, ellipsis has no special power to amnesty island violations: it's just that what is in the ellipsis site is not what is in the antecedent. What is in the antecedent is a cleft or other 'short source', and because there is no island violation involved in extraction from these sentences, there is no island violation in the ellipsis site.

- (407) a. Abby speaks the same Balkan language that someone (in this room) speaks,  
but I'm not sure who ~~it is~~.
- b. Ben left the party because someone wouldn't dance with him, but I'm not  
sure who ~~it was~~.

This can explain a number of the fragment answer cases, too.

- (408) a. Abby speaks the same Balkan language that someone (in this room) speaks.  
Yeah, Ben ~~it is~~.
- b. The Pope's favorite cocktail is made of beer and what?  
Tomato juice ~~it is~~.

The availability of this possibility makes diagnosing islands in ellipsis sites very difficult. Once we have dropped the requirement that there be strict syntactic isomorphism between ellipsis site and antecedent (and there seem to be good reasons to drop this requirement, as reviewed in section 3.7), we have great difficulty determining what is in the ellipsis site.

I do not want here to offer any definitive answers about whether (clausal) ellipsis can amnesty island violations or not. I do, however, want to offer a few observations about the difficulties that are faced just in trying to tackle this question in the first place.

The first observation is that a distinction should be drawn between cases of domains out of which movement is impossible, on the one hand, and structural configurations which block a *specific* constituent from moving, on the other. The former is what I will call 'islands'; the latter I will call 'frozen constituents'. It is possible to have a configuration where there is no 'island' – that is, no domain out of which a constituent cannot move – and yet a particular constituent is frozen in place. Preposition stranding is a clear case of this. In non-P-stranding languages, the complement of a preposition cannot itself move, but that does not make it an island – subextraction is possible, as the below examples from Abels 2003 show.

- (409) Abels' (194, 195): P-stranding barred in Russian
- a. Ot čego sleduet otkazat'sja?  
of what follows give up-self  
'What should one give up?'
  - b. \*Čego sleduet otkazat'sja ot?  
what follows give up-self of
- (410) Abels' (196, 197): Extraction from PPs OK in Russian
- a. Sleduet otkazat'sja [PP ot vsjačeskih pretenzij [na monopoliju  
follows give up-self of whatsoever hopes on monopoly  
istoričeskogo znanija]].  
historical knowledge  
'One has to give up all hopes on a monopoly on historical knowledge.'
  - b. ?[Na čto] sleduet otkazat'sja [PP ot vsjačeskih pretenzij t]  
on what follows give up-self of whatsoever hopes  
'What should one give up all hopes for?'

By contrast, an environment like an adjunct clause is an island in the sense in which I am using the term here: elements cannot move out of an adjunct clause.

The distinction is important, because no-one has ever proposed that e.g. extraction from the complement of a P (in a language where this is illicit) can be repaired by ellipsis. It clearly cannot be, or Merchant 2001 would not have discovered the P-stranding generalization, which states that this precisely does not occur.

The point is particularly important in the light of Barros et al. to appear's argument against the ability of ellipsis to amnesty left-branch extractions. On the basis of examples like (411), (412), it has generally been thought that clausal ellipsis has the power to repair otherwise illicit left-branch extraction.

- (411) a. She married a tall man, but I'm not sure how tall.  
b. \*She married a tall man, but I'm not sure how tall she married a t man.

- (412) a. Did she buy a ↗green car? — ?No, blue. (Barros et al. to appear's (35))  
 b. \*Blue, she bought a car.

Barros et al. to appear point out that while cases like (412a) are grammatical, cases like (413) are not (example mine).

- (413) Did you hire an ↗experienced composer? — \*No, budding.

The important point is that (412) allows for a short source in the ellipsis site, but (413) – because *budding* cannot appear in predicative position – cannot.

- (414) a. Did she buy a ↗green car? — No, it's blue.  
 b. Did you hire an ↗experienced composer? — \*No, he's budding.

Left-branch extractions, they conclude, are not amnestied by ellipsis: in cases where it looks as if they are, this is actually a case of eliding a different structure. In cases where this is ruled out, as in (413), the 'repair' becomes impossible.

It's clear from data like (413) that ellipsis does not have the general power to render all ungrammatical movements grammatical, and we know this also from the P-stranding generalization. However, what is less clear is whether ellipsis can repair islands in the *narrower* sense – that is, the sense in which adjuncts, subjects etc. are islands. Left-branch extraction is plausibly a case of 'frozen constituents' rather than islands in the sense adopted here (see e.g. Bošković 2005). So what the above data (which are very clear) tell us is that left-branch extraction patterns with P-stranding. It does not, however, directly disconfirm the hypothesis that ellipsis can repair island violations in the narrower sense of 'island'.

Barros et al. to appear argue that ellipsis cannot repair islands in this sense either, on the basis of data similar to that originally adduced by Merchant 2004.

- (415) Does Abby speak the same Balkan language that ↗Ben speaks?  
 a. \*No, Charlie.  
 b. \*No, it's Charlie.

- c. \*No, Charlie speaks it.
- d. \*Charlie, Abby speaks the same Balkan language (that) t speaks.

The ellipsis in (415a) is ungrammatical because the putative ‘short sources’ (415b, c) are infelicitous, and the ‘long source’ (415d) is an island violation. If island violations are repaired by ellipsis, the grammaticality of (415a) would not be expected.<sup>123</sup>

This, however, brings me to my second observation. If we adopt QUD-GIVENNESS as a condition on ellipsis – that is, a condition which makes reference, not (merely) to preceding linguistic material, but to a property of the discourse context – then it becomes very difficult to know whether a given ungrammatical case of ellipsis is ungrammatical because it is island-violating, or ungrammatical because the discourse does not license the ellipsis (i.e. QUD-GIVENNESS is not met). Take, for example, the adjunct-island violating case in (416).

(416) Does Abby speak the same Balkan language that ↗[Ben] speaks?

\*No, Charlie ~~Abby speaks the same Balkan language that t speaks.~~

This sort of example is argued to show that fragments are island-sensitive. However, I would argue that in (416), even with the rising intonation placed on *Ben*, the most salient reading is one in which the speaker is interested in which languages Abby speaks. Wanting to know which languages a person speaks is a natural thing to want to know; it is somewhat less natural to be interested in which pairs of people speak the same language. It’s plausible, then, that the QUD in (415) is therefore *Which languages does Abby speak?*. The ellipsis condition in that case would not license the fragment *Charlie* on its own, as shown below.

---

<sup>123</sup>Note that, as Barros to appear argues, this explains the difference between non-contrastive and contrastive fragments noted by Griffiths & Lipták 2014: non-contrastive cases do allow a short source.

- (i) Abby speak the same Balkan language that someone here speaks.
  - a. Yes, Charlie.
  - b. Yes, it’s Charlie./Charlie speaks it.

- (417) a. Ellipsis condition:  $\bigcup \text{QUD} \Leftrightarrow \bigcup \llbracket \text{E} \rrbracket^F$   
 b. QUD: Which languages does Abby speak?  
 $\bigcup \text{QUD} = \exists x \in \text{language. Abby speaks } x$   
 c. E = Abby speaks the same Balkan language that [<sub>F</sub> Charlie] speaks.  
 $\bigcup \llbracket \text{E} \rrbracket^F = \exists x. \text{ Abby speaks the same Balkan language that } x \text{ speaks}$   
 No mutual entailment, therefore ellipsis not licensed.

Note that a fragment answer which does specify a language *is* licit in this context, even if the focus in the question is on *Ben* (and not the full phrase *the same Balkan language that Ben speaks*)<sup>124</sup>, further suggesting that the QUD in this context concerns the languages that Abby speaks, rather than who she speaks the same language as.

- (418) a. Does Abby speak the same Balkan language that  $\nearrow$ [Ben] speaks?  
 b. No, Slovenian. (Ben speaks Macedonian.)
- (419) a. QUD: Which languages does Abby speak?  
 $\bigcup \text{QUD} = \exists x \in \text{language. Abby speaks } x$   
 b. E = Abby speaks [<sub>F</sub> Slovenian].  
 $\bigcup \llbracket \text{E} \rrbracket^F = \exists x. \text{ Abby speaks } x$   
 Mutual entailment satisfied, so ellipsis licensed.<sup>125</sup>

Note further that if the context is extended to make it clear that the Question under Discussion *is* about pairs of people that speak the same language, rather than just which languages Abby speaks, then to my ear, the island-violating fragment answer improves:

- (420) Context: We have before us lots of people. We know that these people are made up of lots of pairs of people who speak the same language as each other and

---

<sup>124</sup>Facts of this sort are also noted by Griffiths & Lipták 2014.

<sup>125</sup>I haven't indicated the restriction to languages for the existentially closed variable in (419b); this would come about via the contextual restriction on focus alternatives discussed in section 3.4.4.

who do not speak the same language as anyone else. (I.e. John and Mary both speak English and nothing else, Jan and Peter both speak Dutch and nothing else, etc.) A and B are playing a game where A is trying to guess which people belong to which pair. A's just trying to guess the right pairings, though; the actual languages they speak is irrelevant to him, all that's relevant is that the people in the pair speak the same language. B knows the pairings and will answer A's questions. A had already worked out that Abby and Charlie were a pair a while ago, but had forgotten this.

- a. Does Abby speak the same language that  $\nearrow$ [Ben] speaks?
- b. No, Charlie. (You'd already worked that pairing out, remember?)

The context in (420) is an attempt to make clear that the Question under Discussion has to do with the people that Abby speaks the same language as, rather than the actual language Abby speaks. As such, the fragment answer passes the QUD-based semantic condition:

- (421) a. QUD  $\approx$  Which person  $x$  is such that Abby speaks the same language that  $x$  speaks?

$\bigcup$ QUD =  $\exists x$ . Abby speaks the same language that  $x$  speaks

- b. E = Abby speaks the same language that [<sub>F</sub> Charlie] speaks.

$\bigcup$ [[E]]<sup>F</sup> =  $\exists x$ . Abby speaks the same language that  $x$  speaks.

Mutual entailment satisfied, so ellipsis licensed.

As can be seen from the lengthy context provided in (420), it takes a lot of work to make the appropriate QUD salient in these cases. This provides a confound in these cases. If cases like (420) are an improvement, they suggest that perhaps ellipsis can ameliorate islands after all. Note that 'short sources' do not seem very good in (420), at least to my ear:

- (422) a. ??No, it's Charlie.  
 b. ??No, Charlie speaks it.



It should be noted here, however, that many of the judgments here are very difficult. For this reason I do not want to make any definitive claims about the power of ellipsis to amnesty islands, or otherwise. This is a topic which will no doubt continue to be debated fiercely in the literature. The main point I wish to make here is that once syntactic isomorphism is abandoned as a hard requirement, and if the semantic antecedence condition for clausal ellipsis is based on discourse/the QUD – both of which are conclusions which the present work argues for – then the task of working out whether a given ellipsis site contains an island or not becomes extremely hard, and so finding an answer to the question of whether ellipsis amnesties island violations is also extremely difficult.

My last observation, however, is to note some data which may support the view that ellipsis can amnesty island violations. Consider cases like the below.

- (423) He bought a new phone.
- a. Oh really? With what features?
  - b. ... but I don't know with what features.
- (424) He bought a new phone.
- a. Yeah – with 4G, too.
  - b. Yeah, I think with 4G, even.

The elliptical cases above are good. However, these *with*-phrases cannot move in non-elliptical environments.<sup>126</sup>

- (425) a. \*With what features did he buy [a phone t]?
- b. \*With 4G, he bought [a phone t].

---

<sup>126</sup>These are grammatical on irrelevant readings, where the features or 4G are what was used to buy the phone. I am targeting the reading where the PP is interpreted as modifying the DP *a phone*.

If the inability to extract this *with*-PP is an island effect, then the availability of the elliptical cases may suggest that this is being repaired by ellipsis. Note that no ‘short source’ is available for these examples.

- (426) He bought a new phone.
- a. ??With what features is it?
  - b. \*With what features did he buy it?
  - c. \*With what features does it have?

It is possible that these cases can be given an alternative explanation to island repair. I won’t take up this theme in detail here, but merely put the data ‘on record’ in the hope that they will stimulate further debate about whether ellipsis can repair islands.<sup>127</sup>

## 4.6 Conclusion

In this chapter I have argued, following Merchant 2004, that fragments are created via the movement of a focused constituent to a left-peripheral position in the clause, following which the rest of the clause undergoes ellipsis. However, I have argued that this movement is not interpreted, and does not take place at LF. Rather, it is a PF-only movement, driven by the requirement to move a stressed constituent out of the domain of ellipsis. It is not feature-driven, but rather belongs to a class of exceptional movements to which some other elliptical phenomena (such as pseudogapping, and possibly also gapping and non-constituent coordination) may also belong. This allows us to understand why the sort of focus movement postulated for fragments only takes place in elliptical constructions in English: this sort of movement is one that is *driven* by ellipsis.

---

<sup>127</sup>A preliminary investigation suggests that the facts in (423)–(426) also hold for French and German (thanks to Magda Oiry, Jérémy Pasquereau, and Stefan Keine for judgments). However, in French, the judgments were slightly murky about whether cases like (425a) are bad, so at least French data may not bear on the issue, and I haven’t tried to try detailed conclusions from these judgments.

In this chapter, I have only considered movement to the left periphery of matrix clauses. However, nothing in principle should rule out movement of fragments to the left periphery of embedded clauses. It turns out, however, that there are interesting constraints in English on when this can happen and when it cannot. These constraints are the subject of the following chapter.

## CHAPTER 5

### EMBEDDING FRAGMENTS

#### 5.1 Introduction

Given the analysis provided of fragments as clausal ellipsis – that is, a process similar to sluicing except that the elliptical remnant is a focused phrase rather than a *wh*-phrase – we might expect that fragments can appear in embedded contexts. Sluicing is clearly possible in embedded contexts:

- (427) Someone left.
- a. I wonder who ~~left~~.
  - b. I found out who ~~left~~.

Are fragments possible in embedded contexts? Stainton 2006b answers this question in the negative, on the basis of cases like the below.

- (428) Who left?
- a. \*I think that John ~~left~~.
  - b. \*I wonder if John ~~left~~.
  - c. \*I don't know whether John ~~left~~.

The ungrammaticality of such cases forms part of Stainton's case that fragments do not involve ellipsis of a clause; if they did, argues Stainton, we should expect to see them in embedded contexts.

However, note the following range of data.<sup>128</sup>

(429) Who left?

- a. I think John.
- b. I believe John.
- c. I hope John.
- d. I was told John.
- e. I said John.
- f. I suppose John.
- g. I suspect John.

(430) Who left?

Mary {thinks/believes/hopes/was told/said/suspects/supposes} John.

(431) Where did he go?

I {think/believe/hope/was told/said/suspect/suppose} to Paris.

(432) Whose car is that?

I {think/believe/hope/was told/said/suspect/suppose} John's (car).

In addition to the constructed data above, I adduce below a number of 'live' attested cases of apparent embedding of a fragment answer.

---

<sup>128</sup>Stainton also notes that cases like the below are grammatical (p. 116).

- (i) What can we have for dinner?
  - a. We hope strawberries.
  - b. If you're on a diet, then strawberries.

Stainton says that these represent exceptions: the generalization is that fragments cannot embed. However, no theory is given of why cases like (i) are possible at all. I will argue that cases like (i) represent the correct generalization, and cases like (428) are to be ruled out for other reasons.

- (433) [TV quiz show program *Was It Something I Said*, Channel 4 (UK), Nov. 24, 2013.  
Context: two teams are given a quote and asked to guess who said it.]  
Moderator: OK, so *you* [gestures at one team] think Donald Trump.<sup>129</sup>
- (434) [Context: The author's parents and the author, due to a disagreement about how many words an average manuscript page contains, and the lack of a word count feature on the author's L<sup>A</sup>T<sub>E</sub>X editor, are trying to work out how many words of dissertation the author had written up to that point. Jan 7, 2014.]  
Author's mother: So Andrew thinks 40,000.<sup>130</sup>
- (435) [BBC TV program *Sherlock*, episode 'The Empty Hearse', broadcast Jan. 1, 2014.]  
Mrs. Hudson: Have you set a date [for your wedding – AW]?  
Mary Morstan: Well, we thought May.
- (436) [Documentary *28 Up*, Granada Studios (UK), 1984. Context: the director is interviewing Suzy at age 28, having last spoken to her when she was 21. She has, between those ages, married a man called Rupert.]  
Director: When I last saw you at 21, you were nervous; you were chain smoking. You were uptight. And now you seem happy. What's happened to you over these last 7 years?  
Suzy: I suppose Rupert.

---

<sup>129</sup>Note that in this case, the overt antecedent *Who said this?*, while it had been said at some point, had not been uttered at a time immediately preceding the moderator's utterance here. This is support for the QUD-based antecedence condition on clausal ellipsis defended in chapter 3; while there is no immediate linguistic antecedent for the question 'Who said this', that Question under Discussion is very salient in the context of the object of the game being played.

<sup>130</sup>This was a very large overestimate.

(437) [Comment on the website *Lifehacker*<sup>131</sup>]

I'm not sure how many fast food employees comment on Lifehacker, though. I hope a lot!

All of these cases seem to show a remnant of ellipsis under an embedding verb like *think*, *believe*, *was told* etc. The cases in (430), and (433)–(435), show that the subject can be other than the speaker.<sup>132</sup> The cases in (431) and (432) are intended to show the form-matching effects (preposition pied-piping and genitive case marking, respectively) which suggest that these fragments are indeed the result of moving a fragment out of an elided clause. In addition, we can see that Merchant's P-stranding generalization is observed in embedded fragment answers in Dutch (Temmerman 2013b): if the fragment's correlate in an antecedent is the complement of a preposition, then the fragment answer must contain that preposition, as Dutch does not allow preposition stranding.

(438) (Temmerman 2013b's (21), adapted)

a. \*(Naar) wie is Greg (\*naar) aan het kijken?

at who is Greg at on it look  
'(At) who(m) is Greg looking (at)?'

(P-stranding forbidden in question)

b. Ik zou denken ?\*(naar) Lisa.

I would think at Lisa  
'I would think (at) Lisa.'

Such data suggest that there is a strong case that fragments are possible in what look like embedded environments. However, there may still be reasons to be skeptical. In the follow-

---

<sup>131</sup><http://lifehacker.com/by-virtue-of-commenting-on-lifehacker-you-are-one-of-t-1533459492>

<sup>132</sup>This is contra judgments in Temmerman 2013b, who claims that cases like this are ungrammatical. See discussion below.

ing section, I give further reasons to believe that fragments do indeed appear in embedded environments.

## 5.2 Embedded fragments are embedded

### 5.2.1 Distinguishing embedded fragments from direct speech

A first hypothesis might be that the supposedly embedded fragments shown above do not in fact contain ‘true’ syntactic embedding, but are rather direct speech reports, of the sort below.

- (439)
- a. I thought to myself, ‘am I going mad?’
  - b. John asked me when I was leaving, and I said ‘I’ll leave tomorrow’.
  - c. Bill was told ‘you’re an idiot’.

- (440) Who left?
- a. I was told ‘John’.
  - b. I think ‘John’.
- etc.

As can be seen from (429), many of the verbs which are reported above as embedding fragments can also take complements which are direct, quoted speech. Could the embedded fragments be of the sort shown in (440)? If so, these would not be cases of genuine embedded clausal ellipsis, but rather cases in which a speech act containing a *matrix* fragment is taken as complement by a verb which can do this.

- (441) Who left?
- I was told ‘John ~~left~~’.

However, there are reasons to believe that fragments under these verbs have a reading which is not direct speech. One obvious reason is that not all of the verbs which embed fragments



can embed quoted speech. We can show this by attempting to perform quotative inversion (Collins & Branigan 1997).

(442) Who left?

Mary {thought/believed/hoped/was told/said/suspected/supposed} John.

(443) John left, {thought/??believed/?\*hoped/said/?\*suspected/?\*supposed} Mary.<sup>133</sup>

Another reason to think that fragments are not direct speech reports is that indexical shift is possible. In direct speech reports, as in (444), indexicals such as the pronouns *I*, *you* and temporal and locative expressions such as *tomorrow*, *now*, *here* have the value which they had in the context of the speech event being reported. However, in indirect speech reports, these indexicals shift and take the value which they have at the time of the matrix utterance, as shown in (445).

(444) a. Mary said ‘I’m an idiot’. (*I* = Mary)

b. Two days ago, Mary was told ‘Hand your essay in tomorrow’. (*tomorrow* = the day after the reported speech event took place, i.e. the day *before* the matrix utterance)

c. When she was in Paris, Mary said ‘I would like to live here’. (*here* = Paris)

(445) a. Mary said that I was an idiot. (*I* = matrix speaker, not Mary)

b. Two days ago, Mary was told to hand her essay in tomorrow. (*tomorrow* = the day after the matrix utterance, i.e. three days after the reported speech event)

---

<sup>133</sup>There is a confound with *tell*; constructions with indirect objects are independently known to be bad in quotative inversion:

(i) (from Collins & Branigan 1997’s (44, 45))

- a. ‘The wind is too strong’, the navigator told the skipper.
- b. \*‘The wind is too strong’, told the navigator the skipper.

- c. When she was in Paris, Mary said that she would like to live here. (*here* = wherever the matrix speech act is taking place, which need not be Paris)

Embedded fragments allow for the shifted reading of indexicals. This shows that such fragments can not (solely)<sup>134</sup> be analyzed as embedding direct speech: indirect speech readings are also possible, suggesting that there is true clausal embedding in these examples.

- (446)
- a. A: Who's an idiot?  
B: Mary said me. (*me* = the matrix speaker)
  - b. A: When should we hand in the essay?  
B: Two days ago, the instructor said tomorrow.  
(*tomorrow* = day after matrix utterance)
  - c. A: Where should one live?  
B: When she was in Paris, Mary said here.  
(*here* = location of matrix utterance)

### 5.2.2 Distinguishing embedded fragments from parentheticals

It has been suggested, e.g. by Temmerman 2013b, that in fact embedded fragment answers are not licit in English. Cases like the above, Temmerman argues, should be considered as cases of parentheticals, parallel to the below cases.

- (447) Who left?  
John, I {think/believe/hope/was told/said}.

That is, fragments such as these would not be truly 'embedded', but would rather be matrix fragments, which were however in construction with a parenthetical appearing to their left

---

<sup>134</sup>The direct speech report is of course possible: *I said 'tomorrow'* etc. However, the fact that shifted readings of indexicals are available shows that a 'true' embedded, indirect speech reading is also possible for these fragments.

or right. In support of this, Temmerman argues that the restrictions on parentheticals appear also in putative cases of embedding of fragments:

(448) Restrictions on parentheticals<sup>135</sup> (Temmerman's (13), originally from Rooryck 2001)

a. *Subject restrictions*

Jules is back, I believe/??you believe.

b. *Tense restrictions*

Jules is back, I believe/I believed/\*I have believed/\*I will believe.

c. *no adverbial modification*

Jules is back, I (\*firmly) believe.

d. *no negation*

Jules is back, I (\*don't) believe.

Temmerman argues that fragment answers show the same patterns. The judgments in parentheses below are those reported by Temmerman.

(449) (Temmerman's (14))

a. *subject restrictions*

Q: Who's responsible for the 9/11 attacks?

(i) (?\*)Michael Moore believes Bush.

(ii) Michael Moore believes Bush is responsible for the 9/11 attacks.

b. *no adverbs*

Q: What's the most beautiful place on earth?

(i) (?\*)I truly believe Kauai.

(ii) I truly believe Kauai is the most beautiful place on earth.

---

<sup>135</sup>I have changed the verbs used in these parentheticals to *believe*. The original examples had verbs such as *know* and *see*; however, there are independent reasons (to be discussed) why such verbs cannot embed fragment answers, and as such do not allow for a fair comparison with parentheticals.

c. *no negation*

Q: Who will win the 2010 World Cup?

(i) (??)I do not believe Brazil.

(ii) I do not believe Brazil will win the World Cup.

I agree that these cases are somewhat degraded in the contexts in which they are presented. However, if certain confounding factors are controlled for, I believe that the cases in (449) are in fact grammatical fragment answers in English, and so suggest that embedded fragments in English cannot in fact be given the same analysis as parentheticals.

Let us first take the subject restriction on parentheticals. The judgment in (449a) implies that Temmerman denies the grammaticality of cases such as (430). But in fact, I find these cases grammatical, as do other English speakers I have asked; witness also the attested examples in (433)–(435). I do not know under what conditions Temmerman collected the data reported in (449a), and so cannot offer a full explanation for why her consultant's reported judgments should differ from mine and my consultants'. I would note, however, that it is important to have a contrastive topic/rise-fall-rise contour on the matrix subject if this subject differs from the first person. Including a 'change of topic' marker at the start of the utterance such as *Well...* also improves the grammaticality of these cases.

(450) a. Who left?

Well, [CT Mary] thinks [CT John].

b. Who's responsible for the 9/11 attacks?

Well, [CT Michael Moore] believes [F Bush].

These sentences also improve if started by *Well I don't know, but...* I suggest that this is because the speaker is pragmatically required to address a question by first giving the answer which is compatible with the best of the speaker's knowledge (i.e. it is as if the questions were *Who do you think left?* and *Who do you think is responsible for the 9/11*

*attacks?* respectively).<sup>136</sup> Starting an answer with *Well I don't know, but...* addresses this question (by stating that the speaker doesn't have an answer to it), and licenses the introduction of another potential source of evidence which might serve to answer the question (Mary's opinions and Michael Moore's, respectively).

(451) a. Who left?

Well, I don't know; but [<sub>CT</sub> Mary] thinks [<sub>F</sub> John].

b. Who's responsible for the 9/11 attacks?

Well, I don't know; but [<sub>CT</sub> Michael Moore] believes [<sub>F</sub> Bush].

Let us consider now the adverbial modification cases in (449b). Again, I think the degree to which these cases are degraded is open to question, and that if the context is manipulated, these cases become more acceptable, in a way parallel to the subject cases.<sup>137</sup>

(452) What's the most beautiful place on Earth?

I told John Kauai, but I actually/secretly {think/?believe} Edinburgh.

(453) What's the most beautiful place on Earth?

Edinburgh, of course, although I stupidly used to {think/?believe} Kauai.

Note that the effect of the embedded fragment in (453) is to give an answer which the speaker no longer believes to be true. This is not a contribution an answer combined with a parenthetical can felicitously make, as (454) shows.

(454) What's the most beautiful place on Earth?

Edinburgh, of course; ?#Kauai, I stupidly used to think.

---

<sup>136</sup>See Roberts 2012/1996 for discussion of the pragmatics of answering questions as part of a discourse.

<sup>137</sup>A contrast does remain between *think*, which is fully acceptable here, and *believe*, which is somewhat degraded, both here and in subsequent examples. I do not have an explanation for this contrast.

That is, *used to think* does seem to take clear semantic scope over the answer in (453), which it cannot do in a clearer case of parenthetical in (454). This supports the view that there is an embedding structure in cases like (453), where *used to think* is genuinely taking a clause *Kauai was the most beautiful place on earth* as complement.

Let us now turn to the negation cases in (449c). Again, I believe that if the context is set up to more clearly pragmatically license the presence of negation in the response, then fragments appearing in construction with negated verbs of belief are not too strongly degraded.

(455) Who will win the 2014 World Cup?

I'm not sure, but I don't {think/?believe} Brazil, anyway.

I therefore dispute the grammaticality judgments presented by Temmerman 2013b which argue for a parenthetical treatment of apparently embedded fragments in English. Further evidence against the parenthetical analysis of these cases comes from some further differences between parentheticals and putative cases of embedded fragments. All of these differences suggest that cases in which a fragment appears to the right of clausal material, they pattern identically with cases of true embedding, and pattern differently from parenthetical cases; suggesting that these cases should indeed be analyzed as embedded elliptical fragments, rather than as matrix fragments in construction with parentheticals.

One example is that negation, in apparent cases of embedding, can license an NPI fragment, while a parenthetical cannot. This supports the view that the apparent embedding in (456a) is indeed embedding.

(456) Who left early?

a. I don't {think/?believe} anybody.

b. \*Anybody, I don't think/believe.

Note that this is not intended to be a movement structure of the form in (457a), but rather a deletion structure of the form in (457b).

- (457) a. [Anybody [I don't think ~~†left early~~]]  
b. [Anybody ~~left early~~] I don't think

The point here is that such parentheticals do not license NPIs in the main clause, but structures like (456a) do, suggesting that structures like (456a) should not be interpreted as cases of parentheticals.

A parallel difference can be seen in an apparent case of pleonastic negation in parentheticals, as in (458).

- (458) Who left early?  
a. Nobody, I (don't) think.  
b. Nobody left the party early, I (don't) think.

In (458), negation within the parenthetical can be optionally expressed. However, this is clearly impossible (at least in dialects of English which lack negative concord) if *I don't think* is placed to the left of the fragment – just as negation is impossible in a case which clearly involves embedding.

- (459) Who left early?  
a. \*I don't think nobody.  
b. \*I don't think nobody left early.

Negation provides another test case which distinguishes apparently embedded fragments from parentheticals. *Nobody* cannot be a good subject for a parenthetical, at least not without sounding ironic (to the extent that it is grammatical, it has the equivalent effect to adding ... *not!* to the end of a sentence; that is, in (460a), the speaker wants to 'trick' the hearer into first believing that John left early, before immediately retracting that assertion).

- (460) Who left early?
- a. \*/#John (left early), nobody thinks.
  - b. \*/#John, nobody thinks, left early.

However, this effect does not obtain if *nobody thinks* is left-peripheral. In that case, the structure is grammatical, and is simply understood as communicating the information that nobody thinks that John left early.

- (461) Who left early?
- (Some people say Mary, some people say Sue,) but nobody thinks John.

A further difference between parentheticals and apparent cases of embedding comes from the ability to embed fragments *within* questions, as in the example in (462). However, as (463) shows, yes/no questions are marginal as parentheticals, and having a *wh*-word as a parenthetical subject is strongly degraded.

- (462) Teacher: What's the capital of Australia? (Canberra or Sydney?)
- [silence]
- Teacher: OK, well, does anybody think Canberra?
- Teacher': OK, well, who thinks Canberra?

- (463) a. ??Canberra, does anybody think?
- b. ?\*Canberra, who thinks?<sup>138</sup>

Another difference between putative embedded fragments and parentheticals is that clausal material that can appear to the left of a fragment can be quite complex, in a way

---

<sup>138</sup>Again, note that these are not meant to be interpreted as movement structures, which would be independently ungrammatical.

- (i) a. ?\*Canberra, does anybody think t is the capital of Australia?
- b. \*Canberra, who thinks t is the capital of Australia?

The point of this example is to show that *who thinks* in (463) is unlikely to be a parenthetical, as it cannot appear as a right-peripheral parenthetical.



that seems incompatible with parentheticals (this example is inspired by ones in McCloskey 2006).

- (464) Where is the most beautiful place on earth?
- a. I would be telling you lies if I said I didn't {think/?believe} Edinburgh.
  - b. \*Edinburgh, I would be telling you lies if I said I didn't think/believe.

Another distinction comes in the following pair of sentences.

- (465) Who signs off our expenses?
- a. In the past, I thought John.
  - b. In the past, John, I thought.

(465a), but not (465b), is compatible with a scenario in which I used to think John signed off the expenses, but subsequently learned that it was someone else; that is, a reading in which *in the past* modifies *thought*. (465b), by contrast, only has a reading (which (465a) also has) in which I am saying that it used to be John that signed off the expenses, although it may now be someone else. That is, in (465b), *in the past* can only modify the (elided) verb *sign off*. Here, again, the point is that the case which looks like embedding (465a) patterns in the same way as the non-elliptical variant which is a clear case of embedding; while the parenthetical example in (465b) has quite different properties, as shown below.

- (466) Who signs off our expenses?
- a. In the past, I thought John signed off our expenses.
  - b. In the past, John signed off our expenses, I thought.

A final difference between parentheticals and apparent cases of embedded fragments is that the class of verbs which are licensed in true (i.e. right-peripheral) parentheticals and the class of verbs which appear to embed fragments (i.e. left-peripheral) are not the same.

Some cases of this are the verbs *find out*, *confirm*, and *confess*. Such verbs can appear as right-peripheral parentheticals:

- (467) Who left?
- a. John, I found out.
  - b. John, I can confirm.
  - c. John, I confess.

However, they are degraded when they are positioned before the fragment.

- (468) Who left?
- a. ??I found out John.
  - b. ??I can confirm John.
  - c. ??I confess John.

The reason for this asymmetry is not obvious on an analysis which assimilates cases like (468) to parenthetical cases.<sup>139</sup> Of course, the reason for the ungrammaticality of (468) is not immediately obvious on an embedding analysis either, given the grammaticality of the below cases.

- (469) Who left?
- a. I found out that John left.
  - b. I can confirm that John left.
  - c. I confess that John left.

The ungrammaticality of the examples in (468) will be analyzed in much greater detail later. For current purposes, however, it suffices to note that the apparent cases of embedding do

---

<sup>139</sup>See also Temmerman 2013b:fn. 27, where the same argument is made against a parenthetical explanation for Dutch embedded fragments.

not pattern with parentheticals on this score, suggesting that they should not be treated as the same phenomenon.

In the face of these differences between parentheticals and apparent cases of embedding, if one wished to maintain a parenthetical analysis, one would have to argue that right-peripheral parentheticals (*John, I think*) have different properties from putative left-peripheral parentheticals (*I think John*). Given that these putative ‘left-peripheral parentheticals’ seem to pattern in almost all ways with cases of true embedding, and do not pattern with parentheticals, I suggest that the null hypothesis for cases in which clausal material appears to the left of a fragment is that they truly do represent embedding of a fragment.

### 5.2.3 Crosslinguistic support for embedded fragments

In some languages, the case for embedded fragments is clearer than in English. For example Temmerman 2013b argues that the below cases are unambiguously embedded fragments in Dutch, contrasting this with English cases which she analyzes as parenthetical. Temmerman gives the below examples to argue against a parenthetical analysis for Dutch.<sup>140</sup>

(470) (Temmerman’s (16), adapted)

- a. Wie dacht je dat de nieuwe directeur zou worden?  
who thought you that the new director would become?  
‘Who did you think would become the new director?’
- (i) Jij / Susan / wij / de vrouwen / Mike en ik denk{t/en} Tom.  
you.SG Susan we the women Mike and I think(s) Tom  
(i.e. no subject restrictions)
- (ii) Ik denk / had gedacht / zou hopen / kan vermoeden Tom.  
I think had thought would hope can suspect Tom  
(i.e. no restrictions on tense or aspect)

---

<sup>140</sup>As I have argued in the preceding section, I believe that all of these tests give a positive result for embedded fragments in English as well, *pace* Temmerman’s reported judgments.

(iii) Ik vrees echt / vermoed stiekem / dacht meteen Tom.

I fear really suspect secretly thought immediately Tom  
(i.e. no restrictions on adverbs)

(iv) Ik dacht (in elk geval) niet Tom.

I thought in any case not Tom  
(i.e. no restrictions on negation)

An even clearer case against a parenthetical analysis for Dutch comes from the fact that, at least for some speakers, the fragment can appear in a position preceding the embedding predicate, as reported by Temmerman 2013b.

(471) Wie dacht je dat de nieuwe directeur zou worden?

who thought you that the new director would become?  
'Who did you think would become the new director?'

a. Ik had gedacht Tom.

I had thought Tom

b. %Ik had Tom gedacht.

I had Tom thought

The word order in (471a), in which *ik had gedacht* 'I had thought' is a contiguous string, might be compatible with a parenthetical analysis. However, the word order in (471b), in which the fragment *Tom* appears in a preverbal position, is unlikely to be compatible with such an analysis. The availability (for some speakers) of structures like (471b), then, is an argument in favor of the availability of embedded fragments in the general case.

Further support for the possibility of embedded fragments comes from languages in which a complementizer appears along with the fragment. The presence of this complementizer is evidence in favor of the presence of an embedded clause in these examples.

- (472) *Spanish* (from de Cuba & MacDonald 2013:ex. (35), adapted)
- a. ¿Quién robó las joyas?  
 who stole the jewels  
 ‘Who stole the jewels?’
- b. Creo / supongo / me imagino / pienso que tu hijo.  
 I.believe I.suppose I.imagine I.think that your son  
 ‘I believe/suppose/imagine/think your son’.
- (473) *Polish* (from Vicente 2013:ex. (65), credited to Agata Renans and Marta Wierzba p.c.)
- a. Którzy jedli czekoladę?  
 who ate chocolate  
 ‘Who ate chocolate?’
- b. Myślę że Beate.  
 I.think that Beate.  
 ‘I think Beate.’
- (474) *Hungarian* (Anikó Lipták p.c., originally from Vicente 2013:ex. (66), credited to Julia Bacskai-Atkari p.c.)
- a. Ki evett csokoládét?  
 who ate chocolate  
 ‘Who ate chocolate?’
- b. Gondolom hogy Béla.  
 I.think that Béla  
 ‘I think Béla.’

At least in Spanish, the presence of a complementizer is not possible in construction with a parenthetical, again diagnosing these cases as true embedding rather than parentheticals.<sup>141</sup>

---

<sup>141</sup>I have not been able to check these data for Polish or Hungarian.

- (475) a. ¿Quién robó las joyas?  
 who stole the jewels  
 ‘Who stole the jewels?’
- b. Tu hijo, creo (\*que).  
 your son I.believe that  
 ‘Your son, I think.’

The case for embedded fragment answers receives crosslinguistic support. Given this, we want to know how to integrate this into an elliptical theory of fragments. This is the task which I address in this chapter.

### 5.3 Restrictions on embedding

The elliptical account is *prima facie* very well equipped to handle embedding, in fact. Following the analysis presented in chapter 4, and ultimately deriving from the analysis presented in Merchant 2001, 2004, we analyze the fragment as moving to the left periphery of an embedded clause, prior to ellipsis of that embedded clause, as below.<sup>142</sup>

- (476) a. Who left? — I think John.
- b.
- 
- The syntax tree for (476) b. is as follows:
- TP (main clause)
    - DP (main clause)
      - I
    - TP (main clause)
      - T (main clause)
      - VP (main clause)
        - V (main clause)
          - think
        - CP (main clause)
          - John
          - CP (embedded clause)
            - C (embedded clause)
            - TP (embedded clause)
              - t<sub>left</sub>

<sup>142</sup>It may seem surprising, in the light of languages like Spanish, Polish and Hungarian (where complementizers precede embedded fragments), that the fragment is located above a complementizer head. The presence of a complementizer in such languages, and the consequences for the syntax proposed here, will be discussed in section 5.11.

In fact, it would be a surprise on a clausal ellipsis account if fragment answers did *not* embed, given the analysis of embedded sluicing cases such as (477) as being cases of clausal ellipsis (Merchant 2001).

(477) a. Someone left. I wonder who.

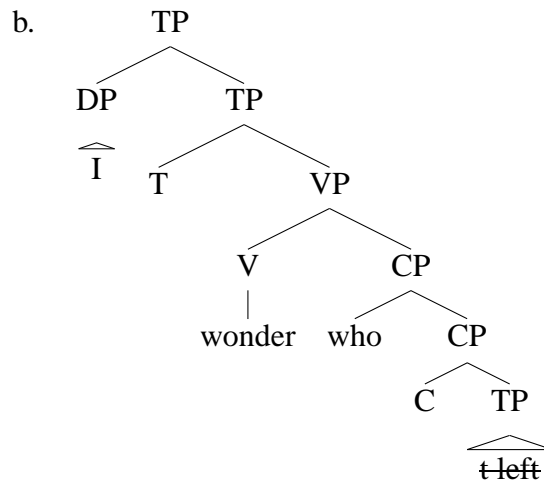

The problem, however, is that the configurations under which fragment answers can embed are very restricted. As pointed out by Stainton 2006b, embedding a fragment answer under a complementizer results in ungrammaticality (in English, as well as in certain other languages such as Dutch and German (Vicente 2013, Temmerman 2013b), but not, as we have seen, in Spanish, Polish, or Hungarian).

(478) Who left?

a. I think/believe/said (that) John left.

b. I think/believe/said (\*that) John.

In addition, as discussed above, the collection of verbs or other predicates which can felicitously embed fragments is restricted.<sup>143</sup>

---

<sup>143</sup>de Cuba & MacDonald 2013 suggest that (the Spanish equivalents of) the answers in (479b–d) are infelicitous as answers even if the full clause is pronounced. I do not share this intuition for English, although some English speakers have suggested to me that they do not find (479b–d) felicitous as responses to the question. Focal stress on *John* helps to bring out the ‘answer’ reading. In any case, I think that the *grammaticality* contrast between (479) and (480) is clear.

- (479) What did John eat?
- a. Mary {thinks/believes/was told/suspects/said} that John ate the cookies.
  - b. Mary {whispered/sighed/quipped} that John ate the cookies.
  - c. Mary {found out/confirmed} that John ate the cookies.
  - d. Mary {is proud/is surprised} that John ate the cookies.

- (480) What did John eat?
- a. Mary {thinks/believes/was told/suspects/said} the cookies.
  - b. \*Mary {whispered/sighed/quipped} the cookies.
  - c. ??Mary {found out/confirmed} the cookies.
  - d. \*Mary {is proud/is surprised} the cookies.

The restriction appears to be that only the class of verbs which have been termed ‘bridge verbs’ in the literature (Erteschik-Shir 1973 and much subsequent work) are those which allow fragment embedding. Similar restrictions are noted for Spanish embedded fragments by de Cuba & MacDonald 2013:ex. (35).<sup>144</sup>

- (481) a. ¿Quién robó las joyas?  
 who stole the jewels  
 ‘Who stole the jewels?’
- b. Creo / supongo / me imagino / pienso que tu hijo.  
 I.believe I.suppose I.imagine I.think that your son  
 ‘I believe/suppose/imagine/think your son.’
- c. #Lamento / sé / me sorprende / me desagrada (que) tu hijo.  
 I.regret I.know me it.surprises me it.displeases that your son

Such facts are also noted for Dutch by Barbiers 2000.

---

<sup>144</sup># is the diacritic de Cuba & MacDonald 2013 put on (481c), which I copy here, although in the theory to be presented here we want to understand such cases as being syntactically ungrammatical rather than semantically infelicitous.



(482) (Barbiers' (23), slightly adapted)

Who will become director?

a. Ik hoop / denk / vermoed / meen / vrees Piet.

I hope think suspect mean fear Piet.

'I hope/think/suspect/mean/fear Piet.'

b. \*Ik betreur / onthul / weet Piet.

I regret reveal know Piet.

In summary, then, a clausal ellipsis theory of fragments, then, needs to account for the fact that complementizers are variably realized in embedded fragments cross-linguistically, and the fact that embedded fragments (at least in English, Spanish and Dutch) are only licensed if they are embedded by so-called 'bridge verbs'. In the remainder of this chapter, I will provide a theory of the syntax of clausal ellipsis which meets these requirements.

#### 5.4 Embedded clauses and the size of the left periphery

The first restriction on fragment answers which I will tackle is the restriction to so-called 'bridge verbs', that is, verbs like *say*, *tell*, *believe*, *think*, *suppose*, *suspect*, *hope*, *imagine*. Non-bridge *verba dicendi* such as *announce*, *mention*, *whisper*, *sigh*, do not embed fragments; nor do factive predicates, such as *know*, *remember*, *realize*, *find out*, *be surprised*, or so-called 'response stance' verbs such as *agree*, *accept*, *deny*.

The verbs which do not allow fragments are also verbs in which extraction at all from their complements is (somewhat) degraded.

(483) a. What did you {think/believe/tell Mary/suspect/say} that John ate t?

b. ?What did you {whisper/sigh/quip} that John ate t?

c. ?%What did you {find out/confirm/deny} that John ate t?

d. ?What are you {proud/surprised} that John ate t?

It is tempting to think that this might account for the pattern of embedded fragments on its own; assuming that fragments move to a left-peripheral position before the rest of the clause is elided, as discussed in chapter 4, then whatever is blocking extraction in (483b–d) might also be blocking the movement of the fragment. However, as shown in (483), object extraction from these complements is only weakly degraded (a comparable degradation to e.g. the extraction in *?What did you wonder whether John ate t?*). In fact, as shown by the diacritics above, it is not clear that extraction of the object from a verb like *find out*, *confirm*, or *deny* is degraded at all; the literature reports varying judgments on such cases. By contrast, trying to embed an object fragment under non-bridge verbs is much more highly degraded.

(484) What did John eat?

- a. Mary {thinks/believes/was told/suspects/said/hopes/supposed/heard} the cookies.
- b. \*Mary {whispered/sighed/quipped} the cookies.
- c. ??Mary {found out/confirmed/remembered/realized} the cookies.
- d. \*Mary {is proud/is surprised} the cookies.

It seems, then, that the degradation which results from extraction of the complement of a non-bridge verb cannot be the sole source of the ungrammaticality of embedded fragments. We should look elsewhere for the source of ungrammaticality in (484).

I propose to appeal to an idea which is widespread in the literature: that the differences between bridge verbs and non-bridge verbs result from differences in the structure of the clauses they embed. In particular, it has been argued that the complements of bridge verbs contain a CP layer which is more articulated than the complements of non-bridge verbs. This hypothesis takes various forms. The most familiar one is the so-called ‘CP recursion’ hypothesis (de Haan & Weerman 1986, Vikner 1991, 1995, Authier 1992, Iatridou & Kroch 1992). Under this hypothesis, complements of bridge verbs embed a

clause which contains two complementizers (one of which is silent, at least in English), and two CPs. The relevant distinction is shown in (485). (The motivations behind proposing this structure, from verb-second phenomena in Germanic, will be discussed in section 5.5.1.)

- (485) a. I {think/believe/said} [<sub>CP</sub> [<sub>C</sub>  $\emptyset$ ] [<sub>CP</sub> [<sub>C</sub> that] [<sub>TP</sub> John ate the cookies]]].  
 b. I {found out/discovered/am proud/remember} [<sub>CP</sub> [<sub>C</sub> that] [<sub>TP</sub> John ate the cookies]].

There exist many other implementations in the literature of the same basic idea, that the complement of bridge verbs is syntactically ‘bigger’ than the complement of non-bridge verbs. For example, Carlos de Cuba in recent work (de Cuba 2007, de Cuba & Ürögdi 2010) has proposed that a ‘recursive CP’ should be seen as a split between two different projections, cP and CP. Bridge verbs embed cP, which in turn embeds CP; other verbs embed CP alone.<sup>145</sup>

- (486) a. I {think/believe/said} [<sub>cP</sub> [<sub>c</sub>  $\emptyset$ ] [<sub>CP</sub> [<sub>C</sub> that] [<sub>TP</sub> John ate the cookies]]].  
 b. I {found out/discovered/am proud/remember} [<sub>CP</sub> [<sub>C</sub> that] [<sub>TP</sub> John ate the cookies]].

Other approaches have greatly expanded the proposed number of functional projections in the clausal left periphery. Most famously, Rizzi 1997 proposes that the clausal left periphery is constituted of a wide number of functional heads, in a hierarchy shown below.

- (487) [<sub>ForceP</sub> Force [<sub>TopP</sub> Top [<sub>FocP</sub> Foc [<sub>TopP</sub> Top [<sub>FinP</sub> Fin TP ]]]]]

---

<sup>145</sup>De Cuba does not himself talk of a bridge/non-bridge distinction, but rather of ‘referential’ CPs versus ‘non-referential’ cPs.

Here Force is a head encoding the speech act force of the clause; Top and Foc are positions which are the target of topic and focus movement, respectively; and Fin encodes the finiteness of the clause.

There have been many refinements proposed in the subsequent literature (the ‘cartographic’ program) to the hierarchy shown in (487). One suggestion that has been made, particularly in work by Liliane Haegeman, is that the complements of non-bridge verbs, as well as certain other clauses such as adverbial clauses, have a ‘truncated’ left periphery; they do not contain the full set of heads shown in (487), but rather only a subset of them. For example, Haegeman 2006b proposes that only FinP is projected in, for example, the complement of a factive verb, as shown below.<sup>146</sup>

- (488) a. I think/believe [<sub>ForceP</sub> [<sub>TopP</sub> [<sub>FocP</sub> [<sub>TopP</sub> [<sub>FinP</sub> that [<sub>TP</sub> John left]]]]]]]  
 b. I know/regret/remember/am proud [<sub>FinP</sub> that [<sub>TP</sub> John left]]

For our purposes, we do not need to focus on the presence or absence of the functional projections which host topic or focus movement in (487).<sup>147</sup> We can note that a key difference between the structures in (487a) and (487b) is that (487a) possesses a complementizer position (Force) which (487b) lacks. In this respect, the cartographic truncation hypothesis is the same as other versions of the ‘CP recursion’ hypothesis; there are two complementizers in the clausal complement of a bridge verb, but only one complementizer in other clausal complements.

In the subsequent discussion, I will distinguish the two complementizers by referring to the ‘higher’ complementizer as C1 and the ‘lower’ as C2. This is a purely expository

---

<sup>146</sup>In more recent work, Haegeman has rejected this hypothesis in favor of an alternative account, in which factive complements and adverbial clauses are not truncated, but rather involve movement of an operator to their left periphery, which has syntactic effects similar to those Haegeman 2006b wished to capture via truncation. See Haegeman 2012 for a detailed general exposition and Haegeman & Ürögdi 2010 for discussion of factive complements specifically.

<sup>147</sup>Having said that, if fragment answers move to one of these positions, an obvious question is whether their absence is what blocks the availability of a fragment answer under these verbs. I shall discuss this more in sections 5.6 and 5.7.

choice, not one intended to commit me to any particular interpretation of the semantic significance of these projections (although as we will see below, I do believe that the presence of the higher complementizer can have semantic effects very similar to those that de Cuba & Ürögdi 2010 discuss, for example). It is also not a choice intended to commit me to any view on how articulated the left periphery is, that is, whether the left periphery consists of a large, variegated number of projections (TopP, FocP etc.) or whether the facts about relative ordering of complementizers, topics, foci etc. should be derived from some other principles of the grammar (see e.g. Abels 2012).

While I am not necessarily committed to a variegated left periphery, I am, however, committed to the widespread view that there exist two complementizer positions in the left peripheries of at least some embedded clauses. How does this help us understand the restrictions on fragment answer embedding? I will propose that the verbs which support fragment embedding are those which contain the higher complementizer C1. Those which contain only the lower complementizer C2, but not C1, cannot embed fragments. I will propose that this is a consequence of a more general constraint: it is the higher complementizer C1 which licenses ellipsis. In clauses which do not contain C1, ellipsis is not possible. In this way we can explain the restrictions on which verbs can embed fragments. To provide further evidence for this view, I will also investigate another phenomenon which has been analyzed as clausal ellipsis, namely sluicing. I will argue that the clauses which can elide under *wh*-movement (i.e. which can sluice) are only those for which there is evidence for a higher complementizer position. This will serve to solve one of the mysteries involved in sluicing, namely that only a certain subset of *wh*-movement constructions appear to license it. The structures in which sluicing is licensed are only those where C1 is implicated.

To start this journey, I will first consider certain properties which separate bridge verbs from other verbs, and which have been hypothesized to diagnose the presence of a double-complementizer structure (or an otherwise variegated left-periphery). We can then apply

those diagnostics to elliptical contexts; on the hypothesis presented above, only cases in which double-complementizer structures are present should be able to show clausal ellipsis.

## 5.5 Syntactic and semantic correlates of a two-complementizer structure

### 5.5.1 Embedded verb-second

The original motivation for a ‘recursive CP’ comes from the phenomenon of ‘embedded verb-second’ in certain Germanic languages (de Haan & Weerman 1986, Vikner 1991, Iatridou & Kroch 1992). In these languages, embedded clauses can show the verb-second behavior generally considered typical of root clauses – but only if the clauses are embedded under bridge verbs.

(489) (German)

- a. Maria sagte/glaubt, Hans **hat** das Buch gelesen.

Maria said/believes Hans has the book read  
‘Maria said/believes Hans read the book.’ (V2 OK)

- b. \*Maria weiß, Hans **hat** das Buch gelesen.

Maria knows Hans has the book read  
(V2 barred)

- c. Maria weiß, daß Hans das Buch gelesen **hat**.

Maria knows that Hans the book read has  
‘Maria knows that Hans has read the book.’ (verb-final order required)

In German, embedded verb-second is in complementary distribution with the presence of an overt complementizer, as shown below.

(490) (Iatridou & Kroch 1992’s (8))

- a. Er sagte, [daß er kommen würde].

he said that he come would

- b. Er sagte, [er wurde kommen].  
 he said he would come
- (491) a. \*Er sagte, [daß er wurde kommen].  
 he said that he would come
- b. \*Er sagte, [er kommen wurde].  
 he said he come would

This is compatible with an analysis in which the auxiliary in T moves into C in verb-second order; if the verb moves into C, a complementizer cannot occupy the same space, and if there is a complementizer in C, the auxiliary cannot move into it. Data like this were the original motivation for the T-to-C analysis of verb-second word order (den Besten 1981/1977). However, some Germanic languages, such as Frisian, allow verb-second to co-occur with complementizers (de Haan & Weerman 1986). The auxiliaries are shown in bold face below.

- (492) (from Iatridou & Kroch 1992's (13), originally from de Haan & Weerman 1986)
- a. Pyt sei dat hy my sjoen **hie**.  
 Pyt said that he me seen had
- b. Pyt sei dat hy **hie** my sjoen.  
 Pyt said that he had me seen
- c. Pyt sei dat my **hie** er sjoen.  
 Pyt said that me had he seen  
 'Pyt said that he had seen me.'

However, non-bridge verbs, such as *regret*, do not allow verb-second in their complements.

- (493) (from Iatridou & Kroch 1992's (14), originally from de Haan & Weerman 1986)
- a. Pyt betreuret dat hy my sjoen **hie**.  
 Pyt regrets that he me seen had

- b. \*Pyt betreuret dat hy **hie** my sjoen  
 Pyt regrets that he had me seen

de Haan & Weerman 1986 analyze this as a case of CP recursion, the projection of two CP layers. The availability of a higher complementizer position under a bridge verb like *say* allows for the complementizer *dat* to be realized in the higher position and the verb to move into the lower position. The lack of the higher complementizer position under a verb like *regret* means that the verb cannot move into a lower position, which is obligatorily occupied by *dat*.<sup>148</sup>

- (494) a. Pyt sei [<sub>CP1</sub> dat [<sub>CP2</sub> hy<sub>1</sub> [<sub>C2</sub> hie<sub>2</sub> ] [<sub>TP</sub> t<sub>1</sub> my sjoen t<sub>2</sub>]]]  
 b. Pyt betreuret [<sub>CP2</sub> dat [<sub>TP</sub> hy my sjoen hie]]

Embedded verb-second behavior, then, is one diagnostic for the presence of a double-complementizer structure.

### 5.5.2 Pro-form *so*

As noted by Kiparsky & Kiparsky 1971, bridge verbs can take the sentential pro-form *so* as their complements. Non-bridge verbs cannot, rather taking the pro-form *it*.

- (495) a. I {think/believe/was told/said/hope/suspect/suppose} *so*.  
 b. I {found out/discovered/denied/agreed/knew} (*it*/\**so*).<sup>149</sup>

de Cuba & Ürögdi 2010 argue that this can be understood as reflecting a syntactic difference in the complements of these verbs. Bridge verbs take CP1 (cP in their terminology)

---

<sup>148</sup>There are unanswered questions here: for example, why are the overt complementizer and verb-second in complementary distribution in German, i.e. why does German not look like Frisian? I will not, however, try to embark on a full exposition of the variation across the Germanic varieties in verb second behavior here.

<sup>149</sup>Jeremy Hartman (p.c.) points out that in some contexts *know so* is acceptable: *I don't just think so, I know so*. I have no explanation to offer for this.



as complement, and *so* is the CP1 pro-form. Non-bridge verbs take CP2 (CP in their terminology) as complement, which does not have *so* as a pro-form.

### 5.5.3 Embedded speech acts and logophoric contexts

A way of semantically characterizing bridge verbs like *say, think, believe, suspect, hope, suppose, tell, hear, guess* is to say that they embed something which can (loosely) be thought of as either speech or thought on the part of the hearer.

This is the kind of predicate which in a number of languages allows for the use of logophoric pronouns in its complement<sup>150</sup>: specialized pronouns which are used to refer to the holder of the embedded speech or thought report (Hagège 1974, Clements 1975, Culy 1994a,b, 1997, Schlenker 2003 a.m.o.).

(496) Distribution of logophoric pronouns in Donno So (Dogon, Mali); from Culy 1994a's (1)<sup>151</sup>

a. Oumar Anta inyemɛñ waa be gi

Oumar Anta LOG-ACC seen AUX said

'Oumar<sub>i</sub> said that Anta had seen him<sub>i</sub>.'

(logophoric pronoun embedded under *say*, corefers with matrix subject)

b. Oumar Anta woñ waa be gi

Oumar Anta 3SG-ACC seen AUX said

'Oumar<sub>i</sub> said that Anta<sub>j</sub> had seen him<sub>k</sub>.'

(non-logophoric pronoun embedded under *say*, may not corefer with matrix subject)

---

<sup>150</sup>I am grateful to Ellen Woolford for directing me towards the literature on logophoric contexts.

<sup>151</sup>Culy's gloss gives the pronoun in (496b) as a logophoric pronoun, and does not mark the pronoun in (496c) as such. However, the surrounding text, and the intention of the example being to show the alternation between logophoric and non-logophoric pronouns, make it clear that these are typographical errors.

- c. Anta wo wa Fransi booje go egaa be  
 Anta 3SG SUBJ France go.FUT-3SG COMP heard AUX  
 ‘Anta<sub>i</sub> heard that she<sub>i/j</sub> will go to France’  
 (non-logophoric pronoun embedded under *hear*<sup>152</sup>, may or may not corefer with matrix subject)
- d. \*Anta inyeme wa Fransi booje go egaa be  
 Anta LOG-3SG SUBJ France go.FUT-3SG COMP heard AUX  
 (intended: ‘Anta<sub>i</sub> heard that she<sub>i</sub> will go to France’)  
 (logophoric pronoun ungrammatical under *hear*)

The predicates which create logophoric environments are not cross-linguistically identical, but certain generalizations can nevertheless be made. In particular, Culy 1994a proposes an influential hierarchy of types of predicate which create logophoric environments.

- (497) (after Culy’s (10))
- predicates of speech (e.g. ‘say’)
  - > predicates of thought (e.g. ‘think’)
  - > predicates of knowledge (e.g. ‘know’)
  - > predicates of direct perception (e.g. ‘hear’)

Culy argues that, for a given language, if a particular type of predicate creates a logophoric environment, then all the types of predicate above it in the hierarchy will also create a logophoric environment (e.g. if *know* does, then *think* and *say* also will).

Unfortunately, English lacks logophoric pronouns, so understanding if a logophoric environment is created in English is difficult. It does seem, though, that we can understand English bridge verbs as belonging to the ‘speech’ and ‘thought’ classes above. Such predicates, for example, allow embedding of the *so* pro-form discussed in the preceding section, which predicates of knowledge or of direct perception do not.

---

<sup>152</sup>*Hear* does not create a logophoric environment in Donna So, but it may in English; cf. footnote 153.

- (498) a. speech: I said so, I was told so  
 b. thought: I think so, I believe so, I hope so, I suspect so, I suppose so  
 c. knowledge: \*I know so, \*I found out so, \*I discovered so, \*I learned so  
 d. direct perception: \*I saw so, \*I smelled so<sup>153</sup>

We might add here predicates of ‘emotion’ such as *be proud*, *be angry*, *be amused*, *be happy* etc. I won’t try to place these precisely in Culy’s hierarchy, but they seem to pattern with knowledge or perception verbs in English, rather than speech or thought verbs, at least with respect to the *so*-diagnostic.<sup>154</sup>

- (499) \*I am proud so, I am angry so, I am amused so, I am happy so

Dubinsky & Hamilton 1998 and Collins & Postal 2012:139f. argue that there is one case in which logophoric contexts are relevant in English. These authors argue that epithets (like *the idiot*, *the bastard* etc.) cannot be bound in a logophoric environment by a c-commanding R-expression, on the basis of contrasts like the below.

- (500) a. \*John<sub>1</sub> thinks that I admire the idiot<sub>1</sub>. (Dubinsky & Hamilton 1998’s (5), cited from Lasnik 1976)  
 b. John<sub>1</sub> ran over a man that was trying to give the idiot<sub>1</sub> directions.  
 (Dubinsky & Hamilton 1998’s (12))

Using this as a diagnostic, we can consider which predicates create logophoric environments in English. The judgments are subtle, but I think that they tend in a direction which confirms the ‘split’ proposed above: predicates of speech and thought create logophoric

---

<sup>153</sup>*Hear* does not seem to quite work in this way: *I heard so* seems fine, and it also embeds a fragment answer (*Who left? – I heard John*), which means that we would want to classify *hear* as a bridge verb, even though it seems to be a verb of direct perception. I suspect what is going on here is that *hear* might also be conceived of as a sort of verb of speech; it’s at least plausible to think that *hear* embeds a speech act, as will be discussed below.

<sup>154</sup>Culy 1994b notes that predicates such as *be happy* do not create logophoric contexts in Dogon, and in this respect Dogon patterns with English.

environments (and so prohibit coreference between a c-commanding R-expression and an epithet), while predicates of knowledge, perception, and emotion do not create logophoric environments (and so allow such coreference).

- (501)
- a. \*John<sub>1</sub> said/was told that I vandalized the idiot<sub>1</sub>'s car.
  - b. ??John<sub>1</sub> thinks/believes/hopes/suspects/supposes that I vandalized the idiot<sub>1</sub>'s car.
  - c. John<sub>1</sub> found out/discovered/learned/knows that I vandalized the idiot<sub>1</sub>'s car
  - d. John<sub>1</sub> saw that I vandalized the idiot<sub>1</sub>'s car.
  - e. John<sub>1</sub> is angry/is proud/is amused that I vandalized the idiot<sub>1</sub>'s car.

This gives us a semantic way of characterizing what bridge verbs embed. One influential way of thinking about it is that bridge verbs do not embed a proposition, as one might think, but rather a different kind of semantic object, a *speech act*.<sup>155</sup> Krifka 2001 and McCloskey 2006 argue for the possibility of embedding a speech act under various kinds of predicates. Their main concern is embedding question speech acts<sup>156</sup>, but the general reasoning extends to embedding assertions also.

Importantly for my purposes here, these authors argue that this corresponds to a syntactic difference exactly equivalent to the one being assumed here. Verbs which embed speech acts embed double-complementizer structures, and the higher complementizer has the semantic role of encoding speech act force.<sup>157</sup> This syntacticization of speech act force finds support in the fact that frequently, in languages with logophoric pronouns, logophoric

---

<sup>155</sup>It perhaps isn't intuitive to think of a verb like *suspect* or *hope* embedding a speech act. Whether we have to be insistent that we are really embedding a speech act as such (in e.g. the sense of Searle 1969 et seq., and in the sense which Krifka 2001, 2012 argues for) is, I think, orthogonal to my concern; for my purposes, it is simply important that bridge verbs embed a different sort of semantic object from what non-bridge verbs embed.

<sup>156</sup>There will be more discussion of embedded question acts in section 5.7.1.

<sup>157</sup>This idea is commonplace throughout the literature; this link is why Rizzi 1997 dubs the highest complementizer position Force.

contexts are embedded under a complementizer different from that which embeds non-logophoric contexts. For example, Clements 1975 reports that in Ewe, logophoric contexts are introduced with the complementizer *be*, which does not appear in other contexts; see also Koopman & Sportiche 1989 and Speas 2004.

We could suppose, for example, that C1 comes in (at least) two ‘flavors’; one, ASSERT, creates the speech act of assertions, while another, QUEST, creates the speech act of questions (see e.g. Krifka 2001, McCloskey 2006). These are present in matrix contexts, and create the speech acts that matrix contexts denote. But they can also be present in embedded clauses, just in case the embedded clause denotes a speech act.

(502) a. John ate chips.

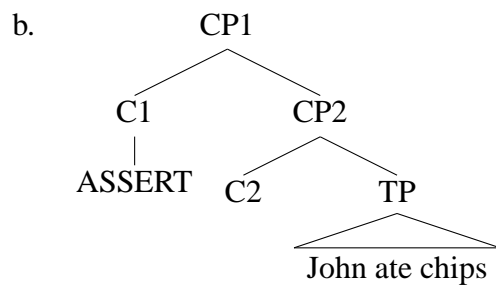

(503) a. What did John eat?

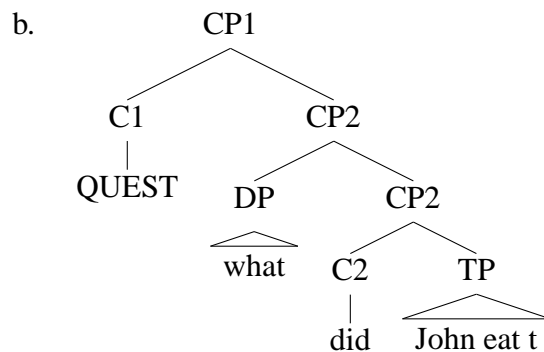

(504) a. I think that John ate chips.

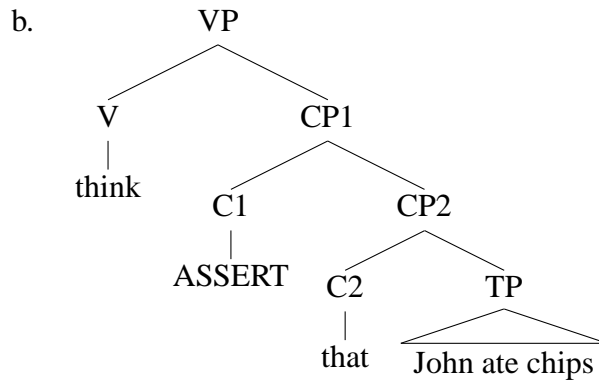

(505) a. I wonder what John ate.

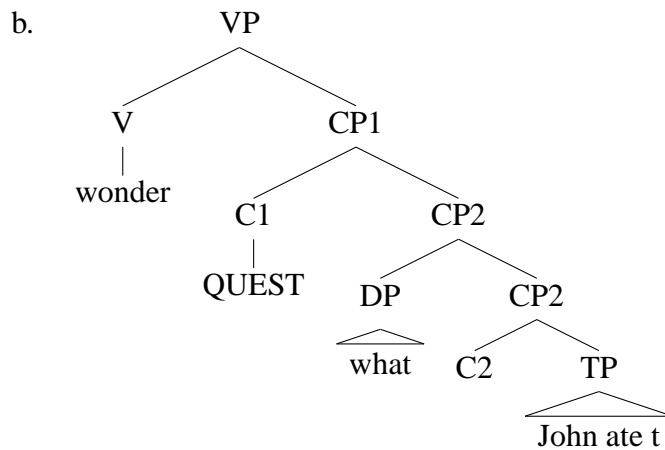

If we accept that bridge verbs embed different semantic objects from non-bridge verbs, and if we agree with McCloskey 2006, de Cuba & Ürögdi 2010, Krifka 2012 and others that the creation of this semantic object is the job of a higher complementizer position, then we have another diagnostic for double-complementizer structures: clauses which plausibly denote speech acts or thoughts are likely to have double-complementizer structures.

#### 5.5.4 A remark on verbs of manner of speaking

Verbs of manner of speaking, such as *whisper*, *sigh*, *quip*, *laugh* and so on seem to fail the *so* test.

(506) \*John whispered/sighed/quipped/laughed/chortled so.

They also do not embed fragments.

(507) Who ate the cookies?

John whispered/sighed/quipped/laughed/chortled Mary.<sup>158</sup>

So we want these verbs to pattern with the non-bridge verbs in general, and this has been generally assumed in the literature. However, it certainly seems intuitively plausible that verbs of this kind embed speech acts, especially as they embed direct speech (*John whispered 'Keep the noise down!'*). If bridge verbs are those that embed speech acts, the non-bridge-verb status of these verbs is puzzling.

One solution to this problem is to suppose that verbs of manner of speaking in fact do not take complements at all, and that their apparent clausal ‘complements’ are actually modifiers or appositives. Snyder 1992 makes this proposal, suggesting that these verbs are underlyingly derived from nominals which combine with a type of relative clause. That is, (508a) is derived from something like (508b), where *make* is perhaps some form of ‘light verb’.

(508) a. John whispered that Mary was lazy.

b. John [<sub>VP</sub> (made) [<sub>NP</sub> (a) [<sub>NP</sub> whisper] [<sub>CP</sub> that Mary was lazy]]]

Kratzer 2006, 2013 has recently also argued that in the semantics, verbs like *say*, *think* etc. take a true semantic argument, while verbs like *whisper*, *sigh* etc. do not take any argument in the semantics, rather combining with their complements via a process such as Predicate Modification. This fits also with Snyder 1992’s observation that these verbs have the option of being syntactically intransitive, in contrast with at least some bridge verbs.

---

<sup>158</sup>This is grammatical on a direct speech reading: *John whispered 'Mary'*. To control for this, we can try embedding an indexical:

(i) When will Mary leave?  
John whispered tomorrow.

This is only grammatical on the direct speech reading, that is, a reading where *tomorrow* means the day after John whispered (i.e. John said the word ‘tomorrow’). It can’t have the paraphrase ‘John whispered that Mary will leave tomorrow’, where *tomorrow* refers to the day after the matrix speech event.

- (509) a. John whispered/shouted/laughed/chortled/?quipped.  
b. John \*said/??believed/\*told.

If this is true, then we can understand why the complements of verbs of manner of speaking seem to behave peculiarly: they do not in fact have complements, but rather a form of appositive restrictor. This also explains why they cannot embed fragments. Their clausal ‘complements’ are in fact relative clauses, and relative clauses cannot undergo clausal ellipsis (a fact to be discussed in more detail in section 5.7.2). As such, we do not expect to see cases such as (510).

- (510) \*John {whispered/shouted/laughed/chortled} the cookies.

I will from now on exclude this class of verb from consideration, and consider only verbs which embed ‘true’ complements.

### 5.5.5 Summary

In summary, we have seen the following properties of the clausal complements of bridge verbs like *say* and *think*:

- They allow embedded verb second in many Germanic varieties.
- They are pronominalized by *so* in English.
- They create logophoric contexts (as shown by the unavailability of epithets coreferential with the matrix subject).

These properties taken together motivate a syntactic distinction between the clausal complements of bridge verbs and clausal complements of other predicates. In particular, embedded verb second has been taken to be diagnostic of a double-complementizer structure.

There is also a consistent way of characterizing bridge verbs semantically: they are always predicates of speech or thought (which are classes of predicates which often create



logophoric contexts cross-linguistically). As such, it is plausible that a semantic distinction should be drawn between what the clausal complements of bridge verbs denote, and what other clausal complements denote. One idea prevalent in the literature is that the complement of bridge verbs denote *speech acts*, while the clausal complements of other predicates denote simple *propositions*. McCloskey and Krifka argue that this distinction is syntactically reflected: the double complementizer structure of the complements of bridge verbs reflects their semantic nature as speech acts. The higher complementizer position has the semantic role of transforming a proposition into a speech act.

Given these properties, we can hypothesize the following diagnostics for double-complementizer structures:

- They should allow verb-second in (some) Germanic varieties.
- They should create logophoric environments.
- They should plausibly denote ‘speech acts’ – that is, they should be analyzable as denoting speech or thought which some agent stands in a relation to.<sup>159</sup>

With these diagnostics in mind, we can investigate what connection there might be between double-complementizer structures and fragments.

## 5.6 Fragments and double complementizers

We have seen that there is a class of verb – bridge verbs – which plausibly embeds a double-complementizer structure. These verbs are also the verbs which embed fragments.

---

<sup>159</sup>This is a somewhat ‘woolly’ characterization. I think, however, that whenever I use this diagnostic to argue against a double-complementizer structure for a particular clause, it will be clear that the clause in question can not denote a ‘speech act’ in this sense.

(511) (repeated from (484))

What did John eat?

- a. Mary {thinks/believes/was told/suspects/said/hopes/supposed} the cookies.
- b. ??Mary {found out/confirmed/remembered/realized} the cookies.
- c. \*Mary {is proud/is surprised} the cookies.

The hypothesis I will pursue is that the head C1 has the power to license the ellipsis of its complement. That statement, coupled with the idea that only bridge verbs embed clauses with a double-complementizer structure, allows us to very simply derive the fact that only bridge verbs allow for fragment embedding. We could say that fragments move to the Spec of C1 to escape ellipsis (in the way discussed in chapter 4), and C1 then licenses the ellipsis of its complement, in the below manner.

(512) (What did John eat?)

I think [<sub>CP1</sub> the cookies C1 [<sub>CP2</sub> C2 [<sub>TP</sub> ~~John ate t~~ ]]]

If it is C1 which has the power to license ellipsis, then the fact that verbs which do not embed C1 – i.e. non-bridge verbs – do not embed fragments simply follows from this.

(513) (What did John eat?)

- a. I found out that John ate the cookies.
- b. ??I found out the cookies.
- c. I found out [<sub>CP2</sub> [<sub>C2</sub> that] [<sub>TP</sub> John ate the cookies]]  
(No C1 in the structure, so ellipsis not possible)

Two questions arise here. The first is whether we can find evidence, separate from fragments, that C1 licenses ellipsis. The second is whether we have discovered that C1 is really the *licensing head* for ellipsis. It may, instead, be the case that C2 (or some other

head) can license ellipsis<sup>160</sup>, but the landing site of fragments has to be [Spec, C1]. If this latter hypothesis were correct, we would have a picture that looked empirically very similar: clauses which lack C1 would indeed be unable to support fragment ellipsis, but this would be because a lack of C1 entailed a lack of ‘space’ to move a fragment into. We wouldn’t have evidence for C1 itself being the ellipsis-licensing head.

My hypothesis, then, is that C1 licenses ellipsis; if a structure lacks C1, it can’t undergo ellipsis. An alternative hypothesis might be that C1 is not the ellipsis-licensing head, but that the Spec of C1 needs to be available to move fragments into. This alternative hypothesis is suggested by de Cuba & MacDonald 2013, for example. The strategy I intend to pursue to tease these two hypotheses apart is to investigate environments in which movement to the left-periphery by *wh*-elements is clearly independently possible, but in which there is evidence that C1 is not present. If my hypothesis is correct, then this kind of clause should *not* show ellipsis (because they lack C1). If the ‘lack of space’ hypothesis is correct, then this kind of clause should (all else being equal) be able to show ellipsis; space is not an issue (as we would know that movement is independently possible, so there must be space).

In what follows, I will argue that my hypothesis is indeed correct: structures which contain *wh*-movement, but which plausibly lack C1, cannot undergo clausal ellipsis, providing support for a view in which C1 licenses ellipsis.<sup>161</sup>

## 5.7 What forms of *wh*-movement license sluicing?

We start from the following well-known observation: not all forms of *wh*-movement license sluicing. For example, the *wh*-movement which is implicated in questions (whether

---

<sup>160</sup>This proposal is made by van Craenenbroeck 2010b, whose analysis will be discussed in section 5.10.

<sup>161</sup>At least in English. Some other languages such as Spanish and Hungarian will be considered in section 5.11.

matrix or embedded) does license it, but the *wh*-movement implicated in relative formation (whether ordinary relatives or free relatives) does not.

- (514) a. What did John cook? [matrix question]  
 b. I wonder what John cooked. [embedded question]  
 c. I ate the curry which John cooked. [relative]  
 d. I ate what John cooked. [free relative]
- (515) a. (John cooked something.) — What ~~did John cook~~?  
 b. (John cooked something.) I wonder what ~~John cooked~~.  
 c. \*John cooked, and I ate the curry which ~~John cooked~~.<sup>162</sup>  
 d. \*John cooked, and I ate what ~~John cooked~~.

This has generally been explained as a feature co-occurrence restriction. Merchant 2001 argues, for example, that the [E] feature which is responsible for licensing ellipsis in his analysis can only co-occur with a particular feature – Merchant labels it [+wh, +Q] – which the *wh*-attracting head in questions possesses, but which is not possessed by the *wh*-attracting head in relatives. van Craenenbroeck 2004, 2010b and van Craenenbroeck & Lipták 2006 make a similar proposal, in which the [E] feature co-occurs with an Op(erator) feature, which requires to be checked by a moved operator such as a *wh*-word, and a Q(uestion) feature, which requires to be checked by a speech act head.<sup>163</sup>

The issue with these analyses is that there is no *a priori* reason why the [E] feature should have to co-occur only with a [wh] or a [Q] feature. This encodes the patterns we see directly, but we are left with the question of why it could not be otherwise. And, in fact, it

---

<sup>162</sup>If we are worried about whether the use of *which* here is a confounding factor, we can note also that even in dialects of English which allow the use of *what* as a relative pronoun (*the curry what John cooked*), sluicing is still impossible: \**John cooked, and I ate the curry what ~~John cooked~~*.

<sup>163</sup>We can see here that this analysis bears a similarity with the present analysis. The difference is that these authors argue that the [E] feature is to be found on the *lower* complementizer, not the higher one. I will discuss these proposals in more detail in sections 5.10 and 5.12.

looks like it can be otherwise: if we are to explain fragments as clausal ellipsis, as we wish to do here, and as Merchant 2004 does, we cannot maintain that the [E] feature has to co-occur with a [wh] feature. What is attracted to the left periphery in fragment constructions is not a *wh*-word. To deal with this, Merchant 2004 proposes that the [E] feature need not co-occur only with a [wh] feature, but can co-occur also with a Focus feature, which drives the movement of a focused constituent to the left periphery. However, once this move is made, it is not clear why the [E] feature cannot be found in relatives. That is, why can relatives not sluice? Why does the [E] feature have to co-occur with either a [wh] or a [Foc] feature, while being unable to co-occur with (for example) whatever feature drives movement of the *wh*-word in relative clauses?

I will argue that an analysis which locates the property of ellipsis licensing only on a high complementizer has a more explanatory answer for why questions can sluice but relatives cannot. Questions contain the higher complementizer; relatives do not. I will extend this reasoning to two other cases of *wh*-movement: so-called ‘unconditionals’, such as *whoever comes to the party, it will be fun*, and exclamatives, such as *what an idiot!*. I will show that the ability to sluice in these cases is linked to the presence or absence of the high complementizer. We consider questions first.

### 5.7.1 Questions

Questions can clearly sluice.

- (516) a. John cooked something. — What ~~did John cook~~?  
b. John cooked something. I wonder what ~~John cooked~~.

On the hypothesis being pursued here, this would imply that double-complementizer structure is possible in questions; so we should look for evidence for this.

One assumption that I make is that the double-complementizer structure is always present in matrix clauses, whether assertions or questions (or indeed other clause types, such as imperatives or exclamatives; the case of exclamatives in particular will be discussed

in section 5.7.4). We always see verb-second in matrix clauses in German, for example, and verb-second is one of the diagnostics we are using for a double-complementizer structure. Furthermore, if the property of being a ‘speech act’ is linked to the property of having a double complementizer structure, then it is plausible that matrix clauses always have double-complementizer structures; matrix clauses, by their nature, always denote speech acts.

If we assume that matrix clauses always have double-complementizer structures, then (516a) is consistent with the hypothesis that double-complementizer structures are necessary for ellipsis. But what about embedded questions, such as (516b)? Is there evidence for a double-complementizer structure in such structures?

Krifka 2002 points out that verb-second is possible in embedded questions in German, especially if the question is preposed.

(517) (adapted from Krifka’s (51, 52))

- a. Doris fragt sich, welches Gericht Al gemacht hat.  
Doris asks self which dish Al made has  
‘Doris wonders which dish Al made.’ (verb-final order in embedded question)
- b. Welches Gericht hat Al gemacht, fragt Doris sich.  
which dish has Al made asks Doris self  
‘Doris wonders which dish Al made.’ (V2 order in embedded (preposed) question)

Krifka shows that cases like (517b) cannot be explained away as a direct speech report (which would be expected to show root-like behavior such as verb-second); in such constructions, indexical elements can show the ‘shift’ which is typical of embedding, but not of direct speech reports. (Direct speech reports are also grammatical, as (518b) shows.)

- (518) a. Welches Gericht soll sie<sub>1</sub> machen, fragt sich Doris<sub>1</sub>  
 which dish should she make asks self Doris  
 ‘Doris wonders which dish she should make.’
- b. “Welches Gericht soll ich<sub>1</sub> machen?”, fragt sich Doris<sub>1</sub>  
 which dish should I make asks self Doris  
 ‘Doris wonders “Which dish should I make?”’

As well as verb-second in German, McCloskey 2006 has also observed similar facts for certain dialects of English. In these dialects, embedded questions allow T-to-C movement (i.e. subject-auxiliary inversion).

- (519) (from McCloskey’s (1, 2))
- a. I wondered [would I be offered the same plate for the whole holiday].
- b. I wondered [was he illiterate].
- c. I asked him [from what source could the reprisals come].
- d. The baritone was asked [what did he think of Mrs Kearney’s conduct].

If a predicate like *wonder* or *ask* selects for a double-complementizer structure, subject-auxiliary inversion is predicted to be possible.<sup>164</sup>

Furthermore, both Krifka 2001 and McCloskey 2006 argue that embedded questions (at least under predicates like *ask* or *wonder*<sup>165</sup>) do denote speech acts. This also follows our intuitive understanding that predicates which embed double-complementizer structures are

---

<sup>164</sup>Some parametric difference would have to be proposed for why only some Englishes allow this movement. We would not want to say that standard English, which does not show T-to-C in embedded questions, lacks a double complementizer structure in embedded questions, given the supposed semantic import of the ‘higher’ complementizer, and the argument that it is this higher complementizer which is involved in ellipsis licensing. This parametrization would, one hopes, follow from whatever parameters are involved in the general variation between the Germanic languages in the presence or absence of (V-to-)T-to-C movement in matrix and embedded environments. I will not try to give a theory of this here, however.

<sup>165</sup>Predicates like *found out who*, *discovered who* etc., which do not seem to embed ‘true’ questions (intensional questions in the terms of Groenendijk & Stokhof 1984) in quite the same way, will be discussed in section 5.8.

predicates of speech or thought: *ask* and *wonder* fall into this category. They also create logophoric contexts which do not allow binding of epithets, as the below examples show.

- (520)
- a. \*John<sub>1</sub> asked if the idiot<sub>1</sub> was allowed to leave early.
  - b. ??John<sub>1</sub> asked who the idiot<sub>1</sub> was allowed to kiss.
  - c. \*John<sub>1</sub> wondered if the idiot<sub>1</sub> was allowed to leave early.
  - d. ??John<sub>1</sub> wondered who the idiot<sub>1</sub> was allowed to kiss.

From all of these facts, we can suppose that questions contain the higher complementizer C1. This predicts that they can show ellipsis, which of course they do. More interesting predictions are made for clauses which contain *wh*-movement but which plausibly do not contain C1.

### 5.7.2 Relatives

Relative and free relative clauses cannot sluice.

- (521)
- a. \*John cooked, and I ate the curry which ~~John cooked~~.
  - b. \*John cooked, and I ate what ~~John cooked~~.

Relative clauses name properties (*which John cooked* =  $\lambda x$ . John cooked  $x$ ); free relatives name entities (*what John cooked* =  $\iota x$ . John cooked  $x$ ). It's clear that such clauses can in no sense be considered to denote speech acts or anything like them. They also do not create logophoric contexts, as shown by the ability of epithets within them to be c-commanded by coreferring expressions:

- (522)
- a. John<sub>1</sub> ran over a man who was trying to give the idiot<sub>1</sub> directions.  
(Dubinsky & Hamilton 1998's (12))
  - b. John<sub>1</sub> only eats what the idiot<sub>1</sub> cooks.



Furthermore, even for speakers of English who allow T-to-C movement in embedded questions, T-to-C movement in relative clauses is impossible.<sup>166</sup>

- (523) a. I ate the curry which John cooked/which John had cooked.  
b. \*I ate the curry which did John cook/which had John cooked.
- (524) a. I ate what John cooked/what John had cooked.  
b. \*I ate what did John cook/what had John cooked.

These facts suggest that C1 is not present in relatives and free relatives. This may be the reason why such structures cannot show ellipsis. ‘Lack of space’ for the ellipsis remnant to move into clearly cannot be the reason for the inability of such clauses to sluice, as we can see that *wh*-movement is possible in principle; it is, however, impossible to elide a relative or free relative.

Having said this, however, we do not have conclusive evidence to link the absence of a higher complementizer and the failure to perform ellipsis. Another possible explanation for the failure of ellipsis in relatives and free relatives is that the relevant semantic relation does not hold. I have argued in chapter 3 that an elided clause must stand in a particular semantic relation to the Question under Discussion: it must be QUD-GIVEN.

$$(525) \quad \cup\text{QUD} \Leftrightarrow \cup[[E]]^F$$

However, this is not a requirement that a relative will meet. Relatives, as mentioned above, denote abstractions over entities (properties); free relatives denote entities. What they do not denote is sets of propositions. As such, they will not be of the right type to participate in the semantic relation given in (525). To make a convincing argument that the presence of a higher complementizer is really what licenses ellipsis, we need to find cases in which

---

<sup>166</sup>Thanks to Hannah Greene for her judgments here. I think that even speakers who do not generally allow T-to-C movement in embedded questions can perceive a distinction between the cases in (523), (524) and e.g. *I wonder what did John cook*.

there is no speech act, T-to-C movement, etc., but where the semantic object created by *wh*-movement plausibly is a proposition or set of propositions. In these cases, QUD-GIVENNESS should in principle be able to license ellipsis. If ellipsis is nevertheless not licensed, we have evidence for the presence of some other factor which is inhibiting ellipsis, or the absence of a factor which is necessary to license ellipsis. I will argue that that factor is the presence of the higher complementizer. In what follows, I will consider two cases of this sort: so-called ‘unconditionals’, and exclamatives.

### 5.7.3 Unconditionals

*Unconditionals* is the name given (Zaefferer 1990, 1991, Rawlins 2013) to constructions like the below (underlined).

- (526) a. Whether Mary comes or not, the party will be fun.  
 b. Whoever comes to the party, it will be fun.  
 c. No matter who comes to the party, it will be fun.

These constructions have been very thoroughly analyzed in work by Kyle Rawlins (Rawlins 2008, 2013). Rawlins argues that these constituents have the syntax of questions, and the semantics of a Hamblin denotation for questions (i.e., a set of propositions). Their semantic function, Rawlins argues, is similar to that of *if*-conditionals. *If*-conditionals serve to restrict the domain of a modal in their scope (Lewis 1975, Kratzer 1979, 1981):

- (527) a. John must pay a fine.  
 ≈ In all worlds compatible with a deontic modal base,<sup>167</sup> John pays a fine.  
 b. If John parked illegally, he must pay a fine.  
 ≈ In all worlds compatible with a deontic modal base *and in which John parked illegally*, John pays a fine.

---

<sup>167</sup>I am neglecting the issue of the ordering source here (Kratzer 1977, 1981).

Rawlins argues that an unconditional has the function of ensuring that a modal in their scope is maximally *unrestricted*. They denote maximal alternative sets, in the fashion shown below.

(528)  $\llbracket \text{Whoever comes to the party} \rrbracket = \{ \lambda w. \text{ John comes to the party in } w, \lambda w. \text{ Mary comes to the party in } w, \lambda w. \text{ Sue comes to the party in } w, \dots \}$

This set of propositions serves as the ‘restrictor’ – actually a widener – for the domain of possible worlds considered by the modal in the unconditional’s scope.<sup>168</sup>

- (529) a. The party will be fun.  
 $\approx$  In all worlds compatible with a particular modal base (which is perhaps contextually restricted), the party is fun.
- b. Whoever comes to the party, it will be fun.  
 $\approx$  {If John comes to the party or if Mary comes to the party or if Sue comes to the party or ... }, it will be fun.  
 $\approx$  In all worlds compatible with a particular modal base, which is not restricted with respect to which people come to the party, the party is fun.

Rawlins gives a number of arguments that these unconditional adjuncts should be syntactically understood as interrogatives. This is clearly the null hypothesis if we are interpreting them as sets of propositions, i.e. Hamblin questions. However, Rawlins points out that many authors (e.g. Dayal 1997, Izvorski 2000) have been inclined to analyze these clauses as free relatives, given the apparent parallel in (530).

- (530) a. John met [whoever came to the party].  
b. [Whoever comes to the party], it will be fun.

---

<sup>168</sup>I am considerably abbreviating Rawlins’ analysis here, which relies on a generalized Hamblin semantics in the vein of Kratzer & Shimoyama 2002, Kratzer 2005, Alonso-Ovalle 2006, and the use of Hamblin (pointwise) function application to perform the restriction. For the details, the reader is referred to Rawlins 2013.

Support for a free relative analysis comes from the fact that in a number of languages, these constructions are demonstrably free relative or correlative structures. For example, in Hindi, the pronoun which is used in these constructions is the relative pronoun, not the interrogative pronoun (Bhatt & Dayal 2014). Note the contrast between (531a), where the relative pronoun *jo* is used, and the ungrammatical (531b), where the interrogative pronoun *kyaa* is used.

(531) (Bhatt and Dayal's (51), slightly simplified)

- a. caahe **jo** ho, swiss bank ke dhankuberõ ke naam chupaa-egaa  
 CAAHE REL be swiss bank GEN moneybags GEN name hide-FUT  
 kendra  
 center  
 'No matter what happens, the center will hide the names of the moneybags  
 of the Swiss Bank.'
- b. \*caahe **kyaa** ho, swiss bank ke dhankuberõ ke naam chupaa-egaa  
 CAAHE what be swiss bank GEN moneybags GEN name hide-FUT  
 kendra  
 center

Rawlins argues, however, that at least for English, an interrogative analysis is appropriate.

The first argument he provides, originally from Huddleston & Pullum 2002, is based on the idiom *what is X doing Y-ing*. This is an idiom which can only appear in an interrogative clause, not in a free relative, as the below contrast shows.

(532) (Rawlins 2013's (99) and adapted (100))

- a. What were they doing reading her mail?
- b. \*He didn't repeat/do what(ever) they were doing reading her mail.<sup>169</sup>

---

<sup>169</sup> *repeat/do* can embed the relevant type of free relative in general, cf. *He didn't repeat/do what they were doing*. However, the idiomatic construction *what is X doing Y-ing* is not possible here.

Now note that the *what is X doing Y-ing* construction is available in unconditionals, suggesting that the syntax of an unconditional patterns with an interrogative rather than a free relative, at least in English.

(533) (Rawlins 2013's (101))

Whatever they were doing reading her mail, it didn't lead to any legal problems.

A second test Rawlins uses is based on the observation, attributed to Jespersen 1909–1949, that if a question is referred to using a *wh*-pro-form, this form is always *what*. However, if a free relative is referred to using a *wh*-pro-form, this form has to match the head of the free relative, as shown below.

(534) (Rawlins 2013's (102))

Alfonso knows who Joanna talked to.

- a. What does Alfonso know? / Alfonso knows WHAT?
- b. #Who does Alfonso know? / Alfonso knows WHO?

(535) (Rawlins 2013's (103))

Alfonso talked to whoever Joanna did.

- a. #What did Alfonso talk to? / Alfonso talked to WHAT?
- b. Who did Alfonso talk to? / Alfonso talked to WHO?

Rawlins then offers the following observation.

(536) (Rawlins 2013's (104))

Whoever Joanna talked to, Alfonso will be jealous.

- a. Alfonso will be jealous regardless of WHAT?
- b. #Alfonso will be jealous regardless of WHO?

That is, the *wh*-pronoun under *regardless of* can be *what*, despite the fact that the unconditional which it presumably resumes is headed by *whoever*. This is not expected if uncon-

conditionals are free relatives, which impose a matching requirement between their heads and pronouns used to refer back to them. It is, however, expected on an analysis which gives unconditionals the syntax of questions.

The third argument offered by Rawlins in support of an interrogative syntax for unconditionals is the fact that multiple *wh*-items are possible within them. This is possible in interrogatives in English, but not free relatives.

(537) (Rawlins 2013's (105–108))

- a. Alfonso knows who said what. [interrogative]
- b. \*Alfonso talked to who(ever) said what. [free relative]
- c. Whoever buys whoever's property, the town council will still grant a building permit. (Gawron 2001)
- d. ?Whoever said what to whom, we've got to put this incident behind us and work together as a team. (Huddleston & Pullum 2002)

This offers further support for a syntactic analysis of unconditionals as having interrogative syntax.

Having established, following Rawlins 2013, that unconditionals have the syntax of interrogatives and the semantics of Hamblin questions, we might imagine *prima facie* that they should be able to show clausal ellipsis. However, they cannot.<sup>170</sup>

---

<sup>170</sup>Having said that, there are interesting potential counterexamples involving both a *wh*-element and what looks like a fragment.

- (i) a. We will hold the party whatever the weather.
- b. He would vote for anyone who supported gun rights, whether Republican or Democrat.

I do not yet have an explanation for these cases, except to note that such cases seem always to involve omission of a form of *be* and possibly a pronoun; it may be possible that these are cases of 'pseudosluicing' (Merchant 2001), that is, *pro*-drop of a pronoun and a null copula, rather than ellipsis *sensu stricto*. That would, however, rely on a theory being provided of why *pro*-drop and copula drop should be available in these environments while not being available elsewhere in English; I am not in a position to provide such a theory here.

- (538) Who's coming to the party?
- a. The party will be fun whoever is coming (to it).
  - b. \*The party will be fun whoever.
- (539) What's John cooking?
- a. You should come to dinner no matter what he's cooking.
  - b. #You should come to dinner no matter what.<sup>171</sup>
- (540) Which dress did she wear?
- a. I'm sure she looked lovely whichever dress she wore.
  - b. \*I'm sure she looked lovely whichever (dress).

Why do the elliptical versions go wrong? In the full versions, the (a) sentences, the material after the head of the unconditional (*whoever* etc.) is de-accented. The *wh*-word is also in focus, as sluicing demands. And assuming Rawlins' semantic account of unconditionals as denoting Hamblin sets is correct, these clauses are also in the correct relation with the Question under Discussion; the examples are constructed so as to make the QUD and the unconditional identical, as shown below (and so taking the union of both sets of propositions will obviously also yield identity between them, as QUD-GIVENNESS requires).

- (541) a. [[Which dress did she wear?]] = {she wore the blue dress, she wore the polka-dot dress, she wore the backless dress, ... }
- b. [[whichever dress she wore]] = {she wore the blue dress, she wore the polka-dot dress, she wore the backless dress, ... }

Even if I am not correct in believing that QUD-GIVENNESS is the correct way of formulating the antecedence condition on clausal ellipsis, it is not obvious what formulation of the

---

<sup>171</sup>This is grammatical as such, but the phrase *no matter what* here is a frozen expression meaning 'in any case'. This utterance cannot be understood as a sluiced version of (539a).

antecedence condition would in fact rule out sluicing here (Merchant’s e-GIVENness also holds, for example). So nothing obvious should rule out sluicing in unconditionals; yet it is impossible. I propose that the culprit in these cases is the lack of a higher complementizer position. If it is C1 which licenses ellipsis, and if unconditionals lack C1, we predict that sluicing of unconditionals should not be possible.

If C1 is the head which is implicated in the creation of a speech act (or something like a speech act), we understand why it should not be expected to be present in an unconditional. An unconditional is a restrictor of a modal, performing a similar semantic function to an *if*-clause adjunct. It is not something like a speech act, or thought. Furthermore, epithet coreference is possible in an unconditional, suggesting that it does not introduce a logophoric context.

(542) John<sub>1</sub> will be happy no matter what the idiot<sub>1</sub> eats.

As such, an unconditional can be analyzed as containing C2 – the head which attracts a *wh*-word – but lacking C1. On the hypothesis being defended here, the lack of C1 means that an unconditional cannot undergo sluicing.

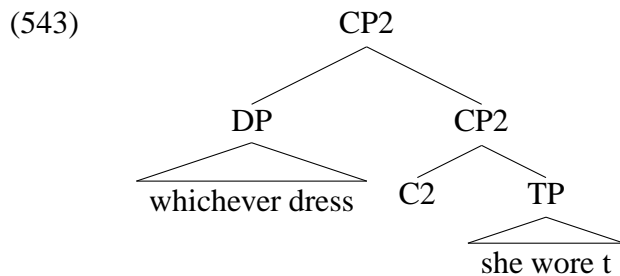

Further support for the lack of C1 in unconditionals comes from the fact that T-to-C movement is not licensed in them, even for speakers of the dialects of English which allows such movement in, for example, embedded questions.<sup>172</sup>

---

<sup>172</sup>Again, I thank Hannah Greene for her judgments.



- (544) a. You should come to dinner no matter what John has cooked.  
 b. \*You should come to dinner no matter what has John cooked.
- (545) a. You should come to dinner whatever John has cooked.  
 b. \*You should come to dinner whatever has John cooked.

From these data, I conclude that the inability to sluice unconditionals provide evidence in support of the hypothesis that a higher complementizer is required to license clausal ellipsis.

#### 5.7.4 Exclamatives

Another corner of English in which we find *wh*-movement is in exclamative constructions such as the below (Elliott 1971, Grimshaw 1979, Zanuttini & Portner 2003, Rett 2008, 2011 a.m.o.).

- (546) a. What an idiot John is!  
 b. What wonderful curry John cooked!  
 c. What a lot of people there were there!

In matrix cases, such *wh*-phrases can show up to the exclusion of other clausal material.

- (547) a. What an idiot!  
 b. What wonderful curry!  
 c. What a lot of people!

Ono 2006 has argued that this is genuine ellipsis, to be taken on a par with sluicing. To his arguments, I add that these cases show the form-matching effects which sluicing does. This is difficult to see in English, but can be seen more clearly in languages such as German.<sup>173</sup> For example, an exclamative *wh*- remnant in the German equivalents of (547) shows up in

---

<sup>173</sup>I am grateful to Stefan Keine for his judgments here.

the case that would be governed by the relevant verb, suggesting that that verb is present but elided.

- (548) a. Hat Maria einen Kuchen gebacken?  
has Maria a.ACC cake baked  
'Did Maria bake a cake?'
- b. Ja – und was für einen Kuchen sie gebacken hat!  
yes and what for a.ACC cake she baked has  
'Yes – and what a cake she baked!'
- c. Ja – und was für einen (Kuchen)!  
yes and what for a.ACC cake  
'Yes – and what a cake!'<sup>174</sup>
- (549) a. Hat Maria einem Studenten geholfen?  
has Mary a.DAT student helped?  
'Did Maria help a student?'
- b. Ja – und was für einem Studenten sie geholfen hat!  
yes and what for a.DAT student she helped has  
'Yes – and what a student she helped!'
- c. Ja – und was für einem (Studenten)!  
yes and what for a.DAT student  
'Yes – and what a student!'

The verb *backen* 'bake' governs accusative case in its object, as (548a, b) show. This case is also present on a *was für* phrase functioning as an exclamative, whether the clausal material in the exclamative is present or not, as shown in (548c). Similarly, the verb *helfen* governs dative case, as shown in (549a, b). Again, a *was für* phrase shows up in dative case in the short exclamative (549c). This suggests that in the cases where there is no clausal material

---

<sup>174</sup>English syntax does not appear to allow the NP ellipsis or *one*-substitution which is permitted in the German case here, as shown by the parentheses. Cp. ??*yes – and what a one!*. I assume this is just a variation in the licensing of NP ellipsis/proforms, rather than telling us anything about the sluicing here.

in the surface form, there is nevertheless a verb assigning case covertly in (548c), (549c), i.e. these are cases of ellipsis.

We also observe Merchant's P-stranding generalization in these cases. In a non-P-stranding language such as German, a 'short' exclamative must show a preposition if there is a correlate in the antecedent, as shown in (550). English, which is a P-stranding language, can optionally express the preposition, as (551) shows.

- (550) a. Hat Maria mit einem Studenten gesprochen?  
 has Mary with a.DAT student spoken  
 'Did Mary speak to a student?'
- b. Ja – und [mit was für einem Studenten] sie t gesprochen hat!  
 yes and with what for a.DAT student she spoken has  
 'Yes – and what a student she spoke to!'
- c. \*Ja – und [was für einem Studenten] sie mit t gesprochen hat!  
 yes and what for a.DAT student she with spoken has  
 (i.e. P-stranding barred)
- d. Ja – und \*(mit) was für einem (Studenten)!  
 yes and with what for a.DAT student  
 'Yes – and what a student!'

- (551) Did Mary speak to a student?
- a. Yes – and what a student she spoke to!
- b. Yes – ?and to what a student she spoke!
- c. Yes – and what a student!
- d. Yes – ?and to what a student!

This implicates the same kind of movement in 'short' exclamatives as is present in the full forms. We can take this, following Merchant 2001's logic, as providing evidence for elided structure in the 'short' exclamatives.

However, there is an interesting contrast between these matrix cases of exclamation and embedded cases. Embedded exclamation do not undergo sluicing, as pointed out by Kim 1997.<sup>175</sup>

- (552) a. A: Is John a genius?  
B: No; in fact, I'm amazed/surprised (by) what an IDIOT John is.
- b. A: Did John cook curry?  
B: Yes, and I'm amazed/surprised (by) what WONDERFUL curry John cooked.
- c. A: Were there a lot of people there?  
B: Yes; in fact, I'm amazed/surprised (by) WHAT a lot of people there were there.
- (553) a. A: Is John an genius?  
B: \*No; in fact, I'm amazed/surprised (by) what an IDIOT.
- b. A: Did John cook curry?  
B: ??Yes, and I'm amazed/surprised (by) what WONDERFUL curry.
- c. A: Were there a lot of people there?  
B: ??Yes; in fact, I'm amazed/surprised (by) WHAT a lot of people.

A minimal pair is shown in (554).<sup>176</sup>

- (554) a. John lost his keys. What an idiot (he is)!
- b. John lost his keys. I can't believe what an idiot \*(he is)!

---

<sup>175</sup>Kim attributes this observation to a 1997 University of Connecticut manuscript 'A Look at Sluicing in Exclamative Constructions' by D. Chen. I have not been able to consult this work. From what I can gather, it proposes that sluicing is ruled out in English embedded exclamation because English lacks the right sort of embedding complementizer. As will be seen, this is quite similar to my proposed analysis.

<sup>176</sup>Ono 2006 claims that examples like the below are grammatical (Ono's (69), sec. 4).

- (i) John wrote an extremely long paper, and it's unbelievable what a long paper.

I do not agree with this judgment, and it also conflicts with Kim 1997's reports. I think the contrast in (554) is very sharp, for example.

The key diagnostic here is the fact that the *what a NP* construction only appears in exclamatives in English. It cannot be used as an interrogative, as many authors have noted (Elliott 1971, Grimshaw 1979 a.o.).

- (555) a. How many people were there?  
b. #What a lot of people were there? (# as question)

Note the minimal pair in (556):

- (556) Were there a lot of people there?  
a. Yes; in fact, I'm amazed by how many people.  
b. ??Yes; in fact, I'm amazed by what a lot of people.

The key observation here is that (556a) has an embedded question reading for *how many people (there were there)*. This embedded question reading can be sluiced. Only when the complement cannot be understood as a question is it impossible to sluice it, as in (556b).

Again, we are faced with the question of why the *wh*-movement which is implicated in exclamative formation should fail to license sluicing in cases like (556b). We might ask if we can use the same argument as we used for relative clauses: the semantic condition might simply not be met, the exclamative clause perhaps not having the right semantic type to enter into the QUD-GIVENNESS relation. However, the fact that matrix exclamatives *can* elide suggests that there is nothing wrong with exclamative clauses entering into the QUD-GIVENNESS relation *per se*. So what goes wrong with clausal ellipsis in embedded exclamatives?

On the current theory, we can understand restrictions of this sort by saying that embedded exclamative clauses lack the higher complementizer which creates a speech act.<sup>177</sup>

---

<sup>177</sup>This would amount to saying that exclamative speech acts cannot be embedded. In a fuller theory, we would want to know why this is the case. Rett 2011 argues that exclamatives cannot be embedded, but she argues that *all* speech acts cannot be embedded. I do not make this assumption here, continuing to hold that assertions and questions can be embedded; but I do not attempt to address the issue here of why questions and assertions should be embeddable speech acts, but exclamatives cannot be.

We can note that embedded exclamatives do not seem to introduce logophoric contexts, as shown by the possibility of epithet binding.

(557) John<sub>1</sub> was surprised by what a lot of letters the idiot<sub>1</sub> got.

Furthermore, if we equate the presence of C1 with ‘root’ behavior in the embedded clause, then evidence for the unembedability of exclamative clauses comes from the German particle *nur*. This particle can appear in matrix exclamatives (Grosz 2012), as shown in (558).<sup>178</sup>

(558) Was bin ich nur für ein Trottel!  
what am I NUR for an idiot  
‘What a fool I am!’

However, this particle *nur* cannot appear in embedded contexts, as in (559).

(559) Maria sagte mir, was ich (\*nur) für ein Trottel bin.  
Maria said to.me what I NUR for an idiot am  
‘Maria told me what an idiot I am.’

This suggests that the matrix exclamative has different properties from the embedded exclamative.

Further syntactic evidence that embedded exclamative clauses lack a C1 layer, while matrix exclamatives possess it, comes from T-to-C movement. Generally, *wh*-exclamatives in modern English do not show T-to-C movement even for speakers who allow T-to-C movement in embedded questions.

(560) a. What amazing curry John has made!  
b. ??What amazing curry has John made!

However, there is evidence that T-to-C movement in exclamatives has been possible in at least some stages in the history of English: for example, the below line from Shakespeare:

---

<sup>178</sup>I am again thankful to Stefan Keine for his judgments.

(561) What a piece of work is a man! (Hamlet, act II, scene ii)

Elliott 1971 notes examples like (562) (Elliott's (39), from Psalm 84).

(562) How lovely is Thy dwelling place, O Lord of Hosts!

And at least my dialect allows (perhaps slightly marginally or archaically) cases like (563) below.<sup>179</sup>

(563) What a fool was I to think that he would fulfill his responsibilities!

But T-to-C movement is degraded in embedded contexts.

(564) a. I can't believe what a fool I was to think that he would fulfill his responsibilities.

b. ?\*I can't believe what a fool was I to think that he would fulfill his responsibilities.

(565) a. We stand in awe of how lovely Thy dwelling place is, O Lord of Hosts!

b. ?\*We stand in awe of how lovely is Thy dwelling place, O Lord of Hosts!

We have been seeing T-to-C movement as diagnostic of a double-complementizer structure. The lack of T-to-C movement in the embedded contexts in (564), (565), contrasted with its (marginal) availability in the matrix case in (563), suggests that the double complementizer structure is not available in embedded 'exclamatives'. On the current account, the higher complementizer C1 is responsible for ellipsis; if it is not present, we do not expect to see clausal ellipsis, as indeed we do not.

---

<sup>179</sup>Somehow the clause headed by *to* makes (563) more acceptable, i.e. *?What a fool was I!* is less good. I do not have a theory for why this should be. There may be a temptation to analyze (563) as a rhetorical question, but note that the *what a NP* construction should be incompatible with this.

(566) a. It surprises me what an idiot John is.

b.

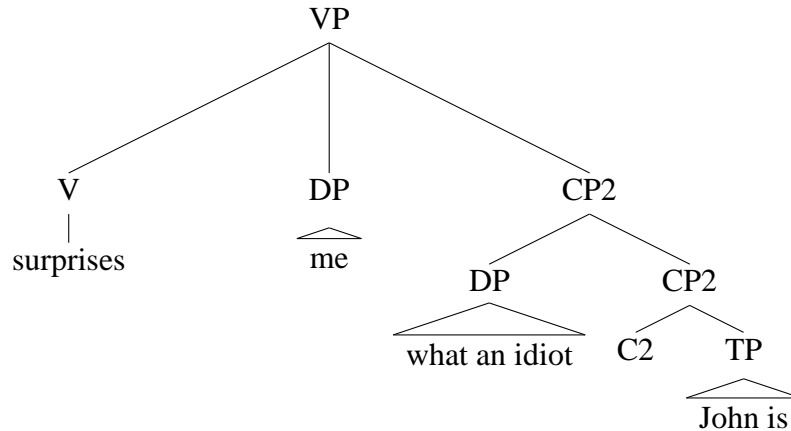

However, we run into a problem with the claim that embedded exclamatives lack C1. If exclamatives denote sets of true propositions, which is the analysis put forward by Zanuttini & Portner 2003, we might imagine that they look very much like cases of sluicing involving embedded factive or ‘extensional’ questions (Groenendijk & Stokhof 1984), such as *Someone left, and I found out who left*. In section 5.8, I will argue that such cases do contain material in C1, specifically, an Answer operator in the sense of Heim 1994, Dayal 1996. And in fact, Zanuttini & Portner 2003 explicitly argue for the presence of a factive operator in the left periphery of exclamatives. If that’s right, and if the factive operator is to be identified with what I am calling C1, then the absence of C1 (and of sluicing) in these cases of embedded exclamatives would be unexpected.

To understand this, I argue that the correct analysis of exclamatives is not the one put forward by Zanuttini & Portner 2003, in which an exclamative denotes a set of propositions. Rather, I adopt the theory put forward by Rett 2011. In this theory, an exclamative like *What an idiot he is!* or *What tasty curry he made!* denotes a type of degree relative. The *what* in the exclamatives ranges over degrees, and pied-pipes the DP it is in. The individual-type variable left behind by the movement of the DP is existentially closed, and the degree-type variable is abstracted over, giving the below (see Rett 2011:(27) for the full derivation).



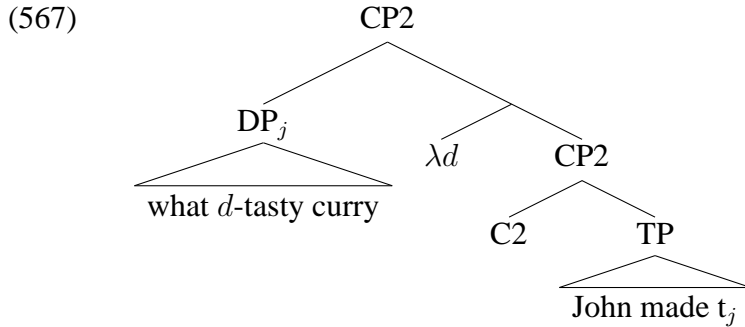

(568)  $\llbracket \text{What tasty curry John made} \rrbracket = \lambda d. \exists x. \text{John made curry } x \text{ that was } d\text{-tasty}$

Having created this degree property, Rett proposes that the abstracted variable  $d$  gets existentially closed (569a) or contextually valued (569b), resulting in a proposition.

- (569) a.  $\exists d. \exists x. \text{John made curry } x \text{ that was } d\text{-tasty}$   
 b.  $\exists x. \text{John made curry } x \text{ that was } d\text{-tasty}$  ( $d$  given by context)

I will assume the contextual provision variant (569b) here. This proposition can then be input to verbs which take propositions as argument.

- (570) a. I found out what tasty curry John made.  
 $\approx$  I found out that John made tasty curry.  
 b. I can't believe what tasty curry John made.  
 $\approx$  I can't believe that John made tasty curry.

My understanding of Rett is that in these cases, the source of the 'high degree' interpretation should be the same in these pairs (whatever that source turns out to be in the evaluative cases, i.e. *John made tasty curry*). But it should be noted that these sentences don't seem like paraphrases of each other. The version with the exclamative syntax seems to require that the degree of tastiness be even higher than the paraphrase with the evaluative version of the adjective. This is particularly clear in (570b). I don't have a detailed solution to offer to this here, except to note that there is a parallel with the degree pronoun *such*, which has a very similar exclamative use (Elliott 1971). If that is included, the paraphrases of (570a, b) become much more apt.

- (571) a. I found out that John made such tasty curry.  
 b. I can't believe that John made such tasty curry.

Note also that while (571b) and (570b) are good, both of (572a, b) are bad.

- (572) a. \*I believe what tasty curry John made.  
 b. \*I believe that John made such tasty curry.

Possibly the presence of an overt degree pronoun – either *such* or *what*, in the relative case – is enough to create a ‘very high’ interpretation.<sup>180</sup> I won't try to flesh this out here, however. The important point for our purposes is that there is a plausible semantics for exclamatives in which they denote relatives. The syntax is also plausible. For example, multiple *wh*-words are degraded in exclamatives, just as they are degraded in relatives (as Rett 2008:167 points out).<sup>181</sup>

- (573) I found out which people went to which party.  
 (multiple *wh*-words OK in questions)

- (574) a. \*I met a man who went to which party.  
 b. ??I met who went to which party.  
 (multiple *wh*-words degraded in relatives)

- (575) a. I found out what amazing people went to that party.  
 b. I found out what a great party my friends went to.

---

<sup>180</sup>Kyle Johnson (p.c.) has pointed out to me that focus on the adjective can have a similar effect.

- (i) a. John's tall. (exceeds the contextual standard for height)  
 b. John's TALL. (very much exceeds the contextual standard for height)

Johnson suggests that there might be an overarching generalization here: spelling out a degree pronoun overtly using *such* or *what* might have the effect of emphasizing a degree which has a similar effect to focus in (i).

<sup>181</sup>However, Ono 2006:71ff. discusses the fact that multiple *wh*-words are licit in Japanese exclamatives. I won't attempt crosslinguistic comparison here.

c. ??I found out what amazing people went to what a great party.

(575c) is not nearly as degraded as (574a), patterning more with the free relative in (574b). I think the reason for this lies in the semantics: it's not at all clear what (574a) could possibly mean, and this is a problem for it above and beyond the syntactic problem of having multiple *wh*-words. By contrast, in (575c), existential closure of the abstracted degree arguments would at least give us a way of calculating what is meant (i.e. that I found out that very amazing people went to an absolutely great party). There's still, I feel, a clear contrast between (575c) and (573); I think this contrast should be interpreted as a failure to license multiple *wh*-words in (575c), and therefore as evidence for relative clause syntax in this example.

The payoff of this excursus is that, if exclamation points are indeed degree relatives, we don't expect C1 to be involved in their syntax. As discussed in section 5.7.2, there is no evidence that C1 is present in relative clauses. So the failure of the below case can be understood in terms of the lack of C1 in the structure.

- (576) a. John lost his keys. \*I can't believe what an idiot ~~he is~~!  
b. [<sub>VP</sub> believe [<sub>CP2</sub> what an idiot [<sub>CP2</sub> C2 [<sub>TP</sub> he is]]]]  
(no C1, so no ellipsis possible)

But how are we then to understand matrix cases? In the matrix cases, I assume as before that C1 is always available, and will serve to provide the speech act force of the entire utterance. I presume that a head EXCL, which types the utterance as an exclamative speech act, is available (although, for reasons which are as yet unclear, this value of C1 can only appear in matrix contexts; that is, there are no embedded exclamative speech *acts*, as discussed above). Rett 2011 and Grosz 2012 argue for the existence of a similar head. C1 being present in the matrix clause allows for ellipsis, as shown below.

(577) a. (John lost his keys.) What an idiot (he is)!

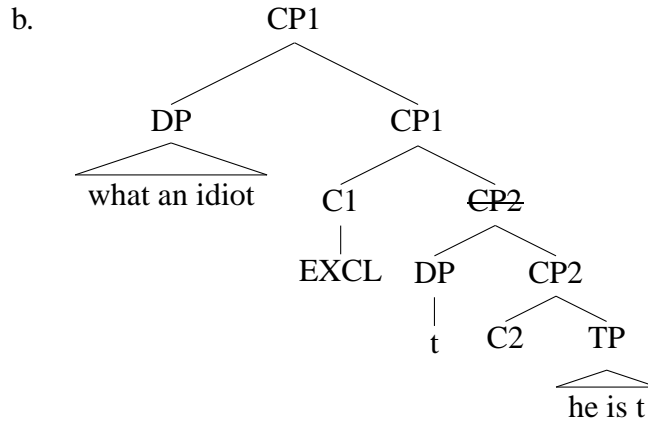

What we have, in effect, is a small corner of English in which a relative clause can show up as a matrix clause. This is possible because the effect of existential closure of the degree property which it denotes results in this clause, which has the syntax of a degree relative, having the semantics of a proposition (here, that John is a big idiot). It is therefore of the right semantic type to be a matrix clause. As a matrix clause, which must denote a speech act, C1 is present. C1 can then license ellipsis, and attract a remnant to its Spec to escape the ellipsis.

Because these exclamatives (after provision of a degree argument) denote propositions – here, the proposition that John is *d*-much of an idiot, where *d* is very large – they can be the input to QUD-GIVENNESS. The degree pronoun is focused in (577a), so we have the below.

(578) a.  $\llbracket \text{What an idiot he is!} \rrbracket = \text{he is } d\text{-much of an idiot}$

b.  $\llbracket \text{What an idiot he is!} \rrbracket^F = \{p \mid \exists d'. p = \text{he is } d'\text{-much of an idiot}\}$   
 $= \{\text{he is a little bit of an idiot, he is somewhat of an idiot, he is an enormous idiot, ...}\}$

c.  $\bigcup \llbracket \text{What an idiot he is!} \rrbracket^F = \exists d. \text{he is } d\text{-much of an idiot}^{182}$

---

<sup>182</sup>We might worry about whether this is trivially true, at least assuming that *he* does not fail to refer; a person will always have some degree of idiocy, even if that degree is 0. This is the same problem as was discussed for degree questions in section 3.4.2. I tentatively suggest that we again exclude 0 from the domain

To license the sluicing, there should be a question under discussion about how much of an idiot John is. I propose that this is easily accommodated along the lines suggested for sluicing in section 3.8.

The hypothesis that C1, but not C2, licenses ellipsis in English, therefore correctly predicts that matrix exclamatives can undergo sluicing, but embedded exclamatives – despite having an apparently parallel syntax and semantics – cannot; matrix exclamatives, but not embedded exclamatives, possess C1.

### 5.7.5 Interim summary

I have argued that questions contain a high complementizer C1, supporting this by showing that (at least in some Germanic varieties) they allow T-to-C movement. Questions are also plausibly thought of as ‘speech acts’, and following the analysis of Krifka 2001, 2012, we can hypothesize that their speech act force is derived from the presence of a high complementizer C1. Further evidence for questions’ speech act status is their ability to create logophoric contexts. If we agree that questions contain C1, then their ability to show sluicing is consistent with the hypothesis that C1 is responsible for clausal ellipsis.

I have also argued that relatives and unconditionals do *not* contain C1; they do not allow T-to-C movement, they are not plausibly analyzed as speech acts, and they do not create logophoric contexts. The hypothesis that C1 is required for clausal ellipsis predicts that relatives and unconditionals should not sluice, and indeed they do not.

Matrix exclamatives can sluice, but embedded exclamatives cannot. I attribute this contrast to the presence of C1 in matrix exclamatives – as C1 is present in all matrix clauses – and the absence of C1 in embedded exclamatives.

---

of relevant degrees, which makes (578c) non-tautologous. However, the statement is still very weak; saying that John has a degree  $d > 0$  of idiocy is not a very strong statement if the scale of idiocy is ‘dense’ (see e.g. Fox & Hackl 2006). It would, for example, be compatible with John having a degree of idiocy  $0 + \epsilon$  where  $\epsilon$  is infinitesimally small. Perhaps the degrees in the focus alternatives in (578b) are contextually restricted to very high degrees. There may be a real stumbling block here; if there is, I am not in a position to solve it.

We can combine these observations with a theory which analyzes the complements of bridge verbs (such as *say*, *think*) as having a double-complementizer structure, while analyzing the complements of non-bridge verbs (such as *find out*, *confirm*, *remember*) as only having the single complementizer C2 (not C1). We then predict the distinction between the fragment-embedding behaviors of these verbs: if C1 is responsible for ellipsis, then we predict only the verbs which embed double-complementizer structures to allow fragments (i.e. clausal ellipsis to the exclusion of a fragment remnant):

(579) (repeated from (512))

What did John eat?

I think [<sub>CP1</sub> the cookies C1 [<sub>CP2</sub> C2 [<sub>TP</sub> John ate t ]]]

(580) (repeated from (513))

What did John eat?

a. I found out that John ate the cookies.

b. ??I found out the cookies.

c. I found out [<sub>CP2</sub> [C2 that] [<sub>TP</sub> John ate the cookies]]

(No C1 in the structure, so ellipsis not possible)

So far, so good. However, there is a problem: not all cases of sluicing are plausibly analyzed as ellipsis of a clause which denotes a speech act, as we might have expected from the above discussion. These are so-called ‘extensional questions’, which I will now discuss.

## 5.8 Extensional questions in sluicing

### 5.8.1 The problem: extensional questions allow sluicing

On the theory being proposed here, the contrast between (581a) and (581b) is explained by reference to the presence or absence of C1. Verbs like *think* embed C1, which licenses ellipsis; verbs like *find out* do not embed C1, and do not license ellipsis.

(581) (What did John eat?)

a. I think the cookies.

b. I {??found out/??confirmed/??remember/\*know} the cookies.

(582) a. I think [<sub>CP1</sub> the cookies C1 [<sub>CP2</sub> C2 [<sub>TP</sub> John ate t ]]]

b. I found out [<sub>CP2</sub> C2 [<sub>TP</sub> John ate the cookies]] (no ellipsis possible)

However, the verbs in (581b) do allow *sluicing* in their complements, casting doubt on this hypothesis.

(583) John ate something, and I {found out/confirmed/remember/know} what.

The questions which are embedded in such cases are referred to by Groenendijk & Stokhof 1984 as ‘extensional questions’: what it means to find out, confirm, remember, or know who ate the cookies is to find out (etc.) the true answer, in the world of evaluation, to the question of who ate the cookies.

These verbs do not seem to prompt T-to-C/V2 behavior when they embed questions (as discussed by McCloskey 2006 and Krifka 2002), one diagnostic we have been using for a double-complementizer structure.

(584) a. \*I {found out/confirmed/remember/know} what did he eat.

b. I {found out/confirmed/remember/know} what he ate.

(585) (from Krifka 2002)

a. \*Welches Gericht hat Al gemacht, {weiß Doris / fand Doris heraus}.

which dish has Al made knows Doris found Doris out  
intended: ‘Doris knows/found out which dish Al made’; V2 order in question

b. Welches Gericht Al gemacht hat, {weiß Doris / fand Doris heraus}.

which dish has Al made knows Doris found Doris out  
‘Doris knows/found out which dish Al made’; verb-final order in question

Embedded extensional questions also do not appear to create logophoric contexts, as the epithet-binding test shows: epithet-binding is possible into them.

- (586) a. John<sub>1</sub> found out/knows/remembers if the idiot<sub>1</sub> is allowed to leave early.  
b. John<sub>1</sub> found out/knows/remembers who the idiot<sub>1</sub> is allowed to kiss.

So the tests we have been using for double-complementizer structures are failing in these cases. This suggests that C1 is not present in embedded extensional questions, which would be very problematic for the thesis adopted here that the double-complementizer structure is required for ellipsis. If that structure is not embedded by verbs of the *find out* class – as the failure to license fragments (*??I found out John*), and the failure of T-to-C movement, seem to be telling us – then how is sluicing possible under such verbs?

My solution will be to argue that, in fact, verbs of the *find out* class *can* embed double-complementizer structures in the general case, and in fact always do so if they embed interrogatives, the data above notwithstanding. I will argue that there is syntactic evidence supporting this conclusion. This will require a revision to the view of C1 suggested above. By all available tests (e.g. logophoric context creation), the complements of verbs like *found out* do not denote speech acts. If I wish to continue to argue that C1 is projected in these structures, then the creation of speech acts cannot be C1's only semantic role. I will argue that this is the case; one possible role of C1 is to create speech acts (i.e. to host operators like ASSERT or QUEST), but another role it has is to transform clauses which denote questions into the true answer to that question; that is, C1 can also host something like Dayal 1996's ANSWER operator.

However, in the case of embedded declaratives (like *I found out that John ate the cookies*), I will argue the C1 layer is not projected. I will argue that this is because it would be syntactically and semantically vacuous to do so. I start by reviewing evidence that verbs like *find out*, *remember* etc. can in fact embed double-complementizer structures in principle.



### 5.8.2 C1 and embedded questions in non-veridical environments

Firstly, note that McCloskey 2006 reports that in non-veridical environments (i.e. embedded under operators that are not truth-value-preserving: under negation, in questions, in imperatives, under intensional predicates like *want to*, etc.), T-to-C movement in embedded interrogatives is in fact possible under verbs like *find out* or *remember*.

(587) (McCloskey's (85))

- a. \*I remember was Henry a communist.
- b. ?I don't remember was Henry a communist.
- c. Do you remember was Henry a communist?

(588) (McCloskey's (92, 93))

- a. Everybody wants to know did I succeed in buying chocolate for Winifred.
- b. Aunt Kate wants to know won't you carve the goose as usual. (James Joyce, *Dubliners*)
- c. I was dying to find out was he circumcised. (James Joyce, *Ulysses*)
- d. Find out does he take sugar in his tea.

This suggests that embedding a double-complementizer structure is at least one possible option for verbs of this class, and that the failure of cases like *\*I remember/found out what did he eat* is not to be located in the syntax per se. That is, subject-auxiliary inversion is not going wrong in such cases because no C1 position is being projected. That is reassuring for our hypothesis that clausal ellipsis requires a double-complementizer structure; the ability to perform T-to-C movement in interrogative complements of verbs like *find out*, in at least some contexts, suggests that double-complementizer structures are indeed possible in the complements of such verbs.

So what is going wrong with cases like (587a)? McCloskey locates the explanation for this failure in the semantics, rather than the syntax. McCloskey notes Ginzburg & Sag 2000's observation that verbs like *find out* – which they term 'resolutive predicates' – bear

a presupposition that the question they embed is resolved. On McCloskey's analysis, T-to-C movement indicates that the embedded clause is a speech act, the act of asking a question. McCloskey suggests that the embedding of a question act in a case like \**Mary found out what did John eat* is incompatible with the presupposition that *found out* brings, that the question is resolved. There is a contradiction between this presupposition that the question is resolved, and the imputing of a relation between Mary and a question speech act.<sup>183</sup> By contrast, embedding such a speech act under a predicate like *wants to find out* – which does not have the presupposition that the question is resolved – does not lead to this incompatibility.

McCloskey does not provide a detailed account of how to understand this semantic contrast formally. Among other things, it is not immediately clear how to understand how *found out* does, but *wants to find out* does not, impose a presupposition that the question is resolved, in a way consistent with a compositional semantics. If the sense of 'resolution' is a presupposition of *find out*, it should project, and be unaffected by the intensional context that *want* brings about. (Compare, for example, *John wants to find out if Mary has stopped smoking*; the presupposition that Mary has at one point smoked is not voided by the intensional context.)

---

<sup>183</sup>The intuition here, I think, is that the only relations one has to question 'speech acts' or 'question thoughts' are things like pondering them, asking them, wanting to find out the answer to them. If Mary has resolved the matter, she is no longer entertaining a 'question thought', so she does not stand in a relation to that 'question thought'. See below for a more technical exposition of this leading idea.

I offer the below sketch of how we might make McCloskey’s analysis more precise.<sup>184</sup> Understand, as McCloskey and Krifka do, the semantics of a question act as being a form of context change potential, a function from contexts to contexts, something like the below.<sup>185</sup>

(589)  $\llbracket \text{QUEST what did John eat} \rrbracket = \lambda c.c'$

where  $c$  is the existing context, and  $c'$  is a context exactly like  $c$  except that the speaker has confessed to a lack of knowledge about what John ate, and indicates that she wants to learn the answer, i.e. sets the Question under Discussion to ‘what did John eat?’

However, the null hypothesis for *find out* – when it embeds a declarative – is that it selects a proposition, not a speech act. Its non-bridge-verb status suggests that this is the case, as argued at length above. So we would want to give *find out* something like the semantics in (590).

(590)  $\llbracket \text{find out} \rrbracket = \lambda p.\lambda x.x$  comes to believe that  $p$  is true.

presupposition:  $p$  is true.

(591)  $\llbracket \text{find out} \rrbracket(\llbracket \text{that John ate the cookies} \rrbracket) = \lambda x.x$  comes to believe that John ate the cookies.

presupposition: John ate the cookies.

---

<sup>184</sup>It is only a sketch. McCloskey makes a comment about his own analysis: ‘[McCloskey’s] discussion skates blithely over some formidably difficult issues. Many questions remain open, and the proposals may or may not survive incorporation into a serious formal framework. Nevertheless, the general approach holds out enough preliminary promise, it seems to me, at the explanatory and descriptive levels [...]’. I do not claim that my discussion here is tackling most or even many of these difficult issues; I am also skating over a number of them. I just aim to develop McCloskey’s leading idea a little further in an attempt to show that, I think, the idea does indeed hold the ‘preliminary promise’ that he mentions.

<sup>185</sup>I purposely leave the precise details of the relevant discourse model quite vague here, as I believe it is orthogonal to the issue. A truly complete implementation would include details pertaining to how the question is integrated into the Common Ground (Stalnaker 1978) or Table (Farkas & Bruce 2010), and exactly how the question has the effect of changing the QUD (Roberts 2012/1996).

If *find out* semantically combines with a proposition, then how can *find out* combine with a question – whether we give a question the type of a set of propositions, or the type of a speech act? The way Krifka 2001 analyzes this is to say that question acts can be type-shifted (by a type-shifter ‘TA’) into the proposition which denotes the true complete answer to the question.<sup>186</sup>

- (592) a.  $\llbracket \text{[QUESTION who ate the cookies]} \rrbracket =$  the speech act of asking who ate the cookies (the context-change potential defined above)
- b.  $\llbracket \text{[TA [QUESTION who ate the cookies]]} \rrbracket = \iota p.p$  is a true and complete answer to the question raised by the speech act in (a).<sup>187</sup>

Given this, the semantics of a structure like *John wants to find out what Mary ate* (or ... *what did Mary eat*) cashes out as follows.

- (593) a.  $\llbracket \text{[what Mary ate]} \rrbracket = \{p \mid \exists x.p = \lambda w. \text{Mary ate } x \text{ in } w\}$   
 $= \{\text{Mary ate the cheese, Mary ate the cake, Mary ate the cookies, ...}\}$   
 (i.e. the set of possible answers)
- b.  $\llbracket \text{[QUESTION what Mary ate]} \rrbracket =$  the speech act of asking what Mary ate
- c.  $\llbracket \text{[TA [QUESTION what Mary ate]]} \rrbracket = \iota p.p$  is a true and complete answer to the question raised by the speech act in (b)
- d.  $\llbracket \text{[find out [TA [QUESTION what Mary ate]]]} \rrbracket = \lambda x.x$  learns the true and complete answer to the question raised by the speech act in (b)

---

<sup>186</sup>In later work, Krifka retracts this proposal, suggesting that interrogatives ‘primarily’ (in our terms, at the C2 level) denote the set of true answers, and this is shifted (by C1, in our terms) into the speech act, rather than shifting the speech act into the set of true answers. Krifka retracts the proposal because of facts like the lack of root clausal behavior (like verb second) under verbs like *find out*, suggesting that – in our terms – C1 is not present in these structures, and that verbs like *find out* never embed speech acts. As I wish to show here, I think that rejecting this proposal was premature. My project here is to argue for the presence of C1 in such structures, at least as an option; I will argue that the lack of root clausal behavior can be understood in other ways.

<sup>187</sup>This is a slight simplification of what Krifka says; Krifka talks about the *sum* of propositions which give a complete answer to the question. This is to allow for apparent cases of quantification over the domain of answers, in cases like *John found out, for the most part, what Mary ate*. We will ignore this here.

- e.  $\llbracket \text{John wants PRO to find out what Mary ate} \rrbracket =$  in all of John's desire worlds, John learns the true and complete answer to the question raised by the speech act in (b).

The key observation now is what happens in a case like *John found out what Mary ate*. This does not allow for subject-auxiliary inversion, and as such, QUEST does not seem to be licensed in such cases. Why? Here is a suggestion, following the suggestions made by McCloskey. The embedded speech act, asking what Mary ate, is a context change potential, which has to be analyzed with respect to a particular agent (an asker or 'ponderer'). It's reasonable to assume that that agent is the agent of the question-embedding predicate, in this case John. So the context change potential that (593b) denotes is something like the following.

- (594)  $\llbracket (593b) \rrbracket = \lambda c.c'$ , where  $c'$  is exactly like  $c$  except that John has confessed ignorance about what Mary ate, and sets the QUD to 'What did Mary eat?'

Here, we could imagine that the function in (594) is only even defined if the agent of the question is ignorant of the answer to the question. (This is a way of encoding the intuition that it is not a felicitous conversational move to ask *What did Mary eat?* if you already know.) But then – elaborating on the argument McCloskey makes about these cases – a statement like *John found out [QUEST what Mary ate]* would be contradictory. The embedded speech act would presuppose that John did not know what Mary ate, but the semantics of the whole utterance asserts that he does, leading to a contradiction.

To be sure, here I am leaving out a lot of steps. In particular, I cannot take up the issue here of precisely how the question act is associated with the agent (that is, how and why it is the case that in an utterance like *John wants to know what Mary ate*, the embedded question act is interpreted as a question being asked by John, rather than, say, a question act that anyone could in principle perform or ponder.) There does seem to be evidence,

though, that this is sensitive to syntactic domains; McCloskey (fn. 27) points out that there is a contrast between the below (I have altered the example slightly).

- (595) a. Do you know what will Freddy do?  
b. \*Do you think Mary knows what will Freddy do?

In (595a), the embedding of a question act (as diagnosed by the presence of T-to-C movement) is possible because the question is interpreted as one asked by the matrix speaker, for whom the issue of what Freddy will do is an open question.<sup>188</sup> That is, the context change potential represented by the [QUEST what will Freddy do] is defined. McCloskey suggests that this evaluation of the question act with respect to the matrix speaker seems to be possible because *want* is a Control predicate, or because it is a restructuring predicate. By contrast, (595b) cannot be so interpreted (even if the question of what Freddy will do is an open one for the speaker). The question act in this case can only be interpreted with respect to Mary as the asker, and infelicity results in the semantic calculation of *Mary knows what will Freddy do*; this asserts that Mary knows what Freddy will do, but presupposes that Mary can felicitously ask the question ‘What will Freddy do?’, which is a contradiction.

Why the syntactic environment should make a difference is a key question, but unfortunately I must put it aside here. However, despite the fact that many such questions remain, I conclude from this that McCloskey’s analysis of the infelicity of cases like *\*Mary found out what did John eat* can be given an appropriate formal treatment, and is more-or-less on the right track.

---

<sup>188</sup>This predicts that if it is *not* an open issue for the speaker – if, for example, it is a rhetorical question/threat, like *Do you know what Freddy will do to you if he finds out?*, where the speaker does in fact know but wants to see if the addressee knows – the T-to-C movement should be infelicitous. This does appear to be the case (thanks again to Hannah Greene for her judgments here).

### 5.8.3 C1, embedded questions, and the Answer operator

We have shown, then, that *find out* and other verbs of its class can, in principle, embed a double-complementizer structure and a question act. This is possible, however, only in non-veridical environments. To that extent, we allow for cases of clausal ellipsis like the below, as they contain C1.

- (596) Someone left.
- a. John wants to find out/discover/confirm/know who.
  - b. Find out/discover/confirm who!
  - c. John didn't find out/discover/confirm/know who.

(597) [<sub>VP</sub> [<sub>V</sub> find out] [<sub>CP1</sub> who [<sub>CP1</sub> QUEST [<sub>CP2</sub> t [<sub>TP</sub> t left]]]]]

However, by the above logic, a case in which the embedded question is within a veridical environment, such as *John found out what Mary ate* (where the verb *find out* is perfective, and is not embedded under *wants to* or similar), does not contain an embedded question act (this is why we do not see *\*John found out what did Mary eat*, in any dialect of English; nor verb-second behavior in the German equivalents of such sentences). That would suggest that such cases do not embed C1. So we still haven't solved the problem that (598) shows; these verbs can embed sluiced clauses, and so – on the hypothesis being advanced here – they should contain C1, which is the head responsible for clausal ellipsis.

(598) John ate something, and I {found out/confirmed/remember/know} what.

And we need to explain the failure of these verbs to embed fragments, as (599) shows.

(599) What did John eat?  
I {??found out/??confirmed/??remember/\*know} the cookies.

On the thesis being presented here, this implies that C1 is present in (598), but not in (599). I will attempt to defend this view by arguing that, in (598), C1 can host a head containing

a semantically contentful element: an element which transforms an embedded ‘question radical’ in Krifka 2001’s terms (that is, a set of propositions, not a speech act) into the true answer to that question. This is an operator like Heim 1994’s or Dayal 1996’s Answer operator. In cases like (599), by contrast, such a head is not required, and so C1 is not projected for reasons of economy; it would be syntactically and semantically vacuous.

Consider first the semantics of a case like (600).

(600) I found out who ate the cookies.

Above, I assumed that *find out* semantically selects for a proposition, and that a question act had to be shifted into the proposition that was the true answer to that question (via Krifka 2001’s ‘TA’ shifter). Something similar needs to be done in (600). The embedded question, which I assume to have the Hamblin denotation (the set of all propositions which constitute possible answers), is not of the right type to combine with a verb that selects for a proposition.

I suggest that one role a head in the C1 position can have is to shift these sets of answers into the proposition which is the true and complete answer. Here is the semantics of an Answer operator, adapted from Dayal 1996, which will do this.<sup>189</sup>

(601)  $[[\text{ANSW}]]^w = \lambda q_{\langle \text{st}, \text{t} \rangle} \cdot \bigwedge \{p \mid p \in q \wedge p(w)\}$

a function from a set of propositions  $q$ , to the conjunction of all the propositions in  $q$  which are true at the world of evaluation  $w$ .

---

<sup>189</sup>If I am locating this operator in the syntax (rather than purely in the semantics as a type-shifting operation) – which I am forced to do, in order to maintain the claim that C1 has a role to play here – then one might ask if the semantic effect of Krifka’s ‘TA’ type-shifter might also be located in the syntax, perhaps in a complementizer position even higher than C1 (in a cartographic implementation of the left periphery, perhaps). I don’t know what tests could be used to settle this question, but there is no immediate reason I can see why it should be ruled out.



(602) (in a world where John ate the cookies and the cake)

- a.  $\llbracket \text{what John ate} \rrbracket^{w_0} = \{p \mid \exists x. p = \lambda w. \text{John ate } x\}$   
 $= \{\lambda w. \text{John ate the cookies in } w, \lambda w. \text{John ate the pretzels in } w, \lambda w. \text{John ate the cake in } w, \dots\}$
- b.  $\llbracket \text{ANSW} [\text{what John ate}] \rrbracket^{w_0} = \bigwedge \{p \mid p \in \{\lambda w. \text{John ate the cookies in } w, \lambda w. \text{John ate the pretzels in } w, \lambda w. \text{John ate the cake in } w, \dots\} \wedge p(w_0)\}$   
 $= \bigwedge \{\lambda w. \text{John ate the cookies in } w, \lambda w. \text{John ate the cake in } w\}$   
 $= \lambda w. \text{John ate the cookies in } w \text{ and John ate the cake in } w$

A question thus transformed into an answer by ANSW can then combine with a proposition-taking predicate like *find out*.

(603) a.

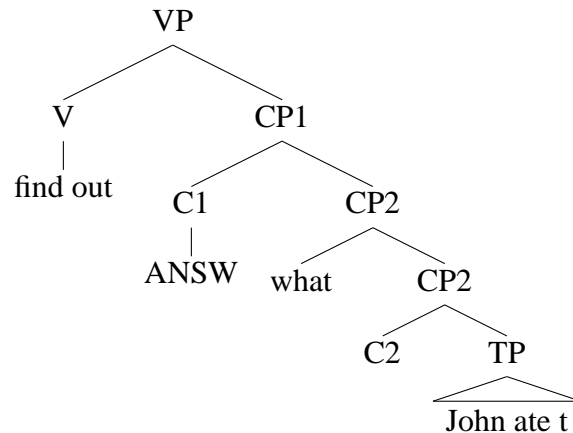

- b.  $\llbracket \text{find out} \rrbracket(\llbracket \text{ANSW} [\text{what John ate}] \rrbracket) = [\lambda p. \lambda x. x \text{ comes to believe that } p \text{ is true}](\lambda w. \text{John ate the cookies in } w \text{ and John ate the cake in } w)$   
 $= \lambda x. x \text{ comes to believe that John ate the cookies and John ate the cake.}$   
 presupposition: John ate the cookies and John ate the cake.

Giving C1 such a role means that C1 is not (just) a speech-act or force-indicating head. I think this is not a problem, however; clearly, different lexical complementizers, even if they occupy the same syntactic position, can have different denotations. I do not think that it is a problem to say that the various lexical heads which can be inserted into the C1 position can have different sorts of meanings, and need not be restricted only to heads

which create speech acts. That is, just as the words which can go into the C2 position range over those shown in (604a) (some of which have different meanings; compare *that* with *if*, for example), the words which can go into the C1 position range over (at least) those shown in (604b).

- (604) a. Words of category C2: {that, if, whether, for,  $\emptyset$ , ...}<sup>190</sup>  
 b. Words of category C1: {ASSERT, QUEST, EXCL, ANSW} (and perhaps others)

I therefore suggest that C1 can indeed be present in extensional questions: the lexical item inserted into this position is ANSW, which turns a question into the proposition which is the true answer to that question. I argue that it is the presence of C1 which licenses sluicing in embedded extensional questions. A *wh*-word can raise to the Spec of C1 to escape ellipsis:

- (605) [<sub>VP</sub> find out [<sub>CP1</sub> what [<sub>C1</sub> ANSW ] [<sub>CP2</sub> ~~t~~ C2 [<sub>TP</sub> John ate ~~t~~]]]]

#### 5.8.4 When do we expect C1?

I have assumed above that the verb *find out* and other verbs of its class (like *know*, *remember* etc.) can in principle embed double-complementizer structures when they embed interrogative complements. This is how I account for sluicing in these structures; C1 is present if these verbs embed interrogative complements, and C1 licenses ellipsis, allowing for structures like (605).

Some questions, however, arise concerning the syntax in (605). The first is why, given the projection of a double-complementizer structure such as the above under verbs like *find out* in general, allowing for structures like *Mary wants to find out what will John eat*, we nevertheless do not (in any dialect of English) see T-to-C movement in sentences like *\*Mary found out what did John eat*, where *find out* is in past tense and is not in an

---

<sup>190</sup> $\emptyset$  is the empty complementizer in e.g. *I think John left*.

intensional environment). Given that I have argued that verbs like *found out* do embed double-complementizer structures, we might expect this to license T-to-C movement in such structures. The answer to this seems to be simply that T-to-C movement in (any dialect of) English only takes place in speech acts, i.e. in the presence of QUEST and (marginally/archaically) EXCL.<sup>191</sup> The fact that (in any dialect of English) T-to-C is obligatory in matrix questions, but barred in matrix declaratives, seems to bear this out.<sup>192</sup>

A second question is why C1 cannot be present in the complements of verbs like *find out* when these verbs embed *declarative* complements. That is, what rules out the below?

- (606) a. (What did John eat?) — ??I found out the cookies.  
 b.  $[_{VP} [_V \text{ found out}] [_{CP1} \text{ the cookies C1 } [_{CP2} [_{C2} \text{ that}] [_{TP} \text{ John ate } t]]]]$

The answer here lies in the semantics. I assume that verbs like *find out* semantically combine with propositions, and that the  $CP2$  *that John ate the cookies* denotes a proposition. Semantic composition can therefore proceed unproblematically in cases like (607).

- (607) a.  $[_{VP} [_V \text{ found out}] [_{CP2} \text{ that John ate the cookies}]]$   
 b.  $[[\text{found out}] = \lambda p. \lambda x. x \text{ came to believe } p \text{ (presupposition: } p \text{ is true)}$

---

<sup>191</sup>Kyle Johnson (p.c.) reminds me that T-to-C movement also appears in negative preposing contexts: *Never have I seen such a thing*. To the extent that negative preposing is a ‘main clause phenomenon’ and is barred if embedded under a predicate like *be surprised* (*??I’m surprised that never has he seen such a thing*; see Hooper & Thompson 1973, Green 1976, and much subsequent work), we might also suggest that it is dependent on the presence of a double complementizer structure/the presence of a speech act head. The data are very complicated, however (see e.g. Haegeman 2012 for discussion and references); I won’t be able to explore T-to-C movement in negative preposing here.

<sup>192</sup>It is less obvious why T-to-C movement should be barred in German under verbs like *find out*.

- (i) \*Welches Gericht hat Al gemacht, {weiß Doris / fand Doris heraus}.  
 which dish has Al made knows Doris found Doris out  
 intended: ‘Doris knows/found out which dish Al made’; V2 order in question; from Krifka 2002

If a double-complementizer structure is projected in the embedded question, the verb should be able to raise into C2, but this does not seem to be possible. We can’t appeal to the question/declarative distinction here, as T-to-C movement takes place in both matrix declaratives and matrix questions in German. I don’t have an answer to this problem. One avenue for investigation would be the hypothesis that it is only a C1 containing a speech act operator (rather than another sort of operator such as ANSW) which drives T-to-C movement. Why that should be the case, though, is not clear.

- c.  $\llbracket \text{that John ate the cookies} \rrbracket = \lambda w. \text{John ate the cookies in } w$

Given the inventory of C1 heads that I have proposed (repeated in (608)), no C1 head in fact has an appropriate semantics to intervene between the verb *found out* and the CP2 *that John ate the cookies*.

(608) Words of category C1: {ASSERT, QUEST, EXCL, ANSW}

The three speech act heads ASSERT, QUEST and EXCL will not do the job. EXCL does not seem to appear in embedded contexts in general (as discussed in section 5.7.4); and QUEST wants to combine with a *set* of propositions such as that which a constituent question like *what John ate* denotes, not with a proposition such as what *that John ate the cookies* denotes. The only plausible candidate would be ASSERT, which combines with a proposition and returns an assertion speech act; but the verb *found out* does not semantically want to combine with a speech act, but rather a proposition. ANSW will not work either. ANSW does return a proposition, which would be of the right type to combine with *found out*; however, ANSW's semantics requires that it combine with the set of propositions that a constituent question denotes, rather than the proposition denoted by a phrase like *that John ate the cookies*.

There is therefore no C1 head, in the inventory I have proposed, which could be inserted in (607a) and which would allow the semantic types to work out correctly. I am assuming that CP1 cannot be projected with a 'radically empty' head, that is, one that has neither any semantic effect nor any phonological content. That is, we don't expect a structure like the below, where C1 is 'radically empty'; the introduction of C1 has to be motivated by some independent requirement of the semantics.<sup>193</sup>

---

<sup>193</sup>This principle requires the assumption that in cases where the (low/C2) complementizer position in English looks like it's radically empty, as in (i), it actually is not; but rather the silent complementizer does have semantic import.

- (i) John said [<sub>CP1</sub> ASSERT [<sub>CP2</sub> [<sub>C2</sub>  $\emptyset$ ] Mary left.]]

(609) \*<sub>[VP [V found out] [CP<sub>1</sub> [C<sub>1</sub>  $\emptyset$ ] [CP<sub>2</sub> that John ate the cookies]]]</sub>

On the assumption that radically empty heads are not a feature of the grammar, structures like (609) containing C1 will never be generated; and if, as this chapter argues, C1 is the licenser of clausal ellipsis, we would not expect declarative complements of verbs like *find out* ever to embed elided clauses, that is, to embed fragments.

I have argued that no C1 head is generated in cases like (609) because there is nothing in the inventory of C1 heads that I have provided which allows the semantic types to work out correctly. Clearly this analysis depends on an understanding of what the inventory of C1 heads is, and what their semantic types can be. On the view defended above, the C1 heads do not form a natural semantic class, either with respect to what they take as argument (propositions in the case of ASSERT and EXCL, sets of propositions in the case of QUEST and ANSW) or with respect to what they return (speech acts in the case of ASSERT, QUEST and EXCL, propositions in the case of ANSW). We want eventually to understand what semantically constrains the inventory of C1 heads in a principled way. I am not in a position to provide that here. I think, however, that it is a reasonable working hypothesis that no C1 head should be postulated in structures like (609). In all the cases we have seen so far where C1 has been postulated, the ‘job’ of the C1 head has been to semantically ‘mediate’ between a verb which wants a certain type of complement (for example, a speech act in the case of *think*, or a proposition in the case of *found out*) and an embedded clause which denotes something of the ‘wrong’ type to directly combine with that verb. C1 acts as a shifter from propositions to speech acts, or from sets of propositions to speech acts, or from sets of propositions to propositions, and so on. In cases like (609), though, the verb and the embedded complement clause are of the correct type to semantically combine.

---

I will not investigate the role of C2 in detail here, but it would not be unreasonable to consider that it has a clause typing role (defining the clause as declarative, interrogative, etc.). For example, it would be the locus of the [ $\pm$ Q] feature which would attract a *wh*-word in constituent questions (and, potentially, have a role in generating the propositional alternatives that constituent questions denote). Therefore, although C2 in (i) is silent, it is not vacuous in the same way that projecting C1 in cases like (609) would be.

As such, it's reasonable to assume that there will be nothing in the inventory of possible C1 heads (whatever that inventory eventually turns out to be) which would be placed in between the verb and the complement clause in (609); no 'mediation' is required.

In conclusion, this analysis explains the asymmetry between declarative complements under verbs like *find out* and interrogative complements. The former cannot show clausal ellipsis (i.e. fragments cannot be embedded under verbs like *find out*), while the latter can (i.e. sluicing is OK in cases like *I found out who*). The reason is that non-bridge verbs like *find out*, when they embed declarative complements, do not embed C1, as there is no C1 which could semantically 'fit' between a non-bridge verb (a predicate which takes a proposition as argument) and a CP2 (a proposition). By contrast, when a verb like *find out* takes an *interrogative* complement (*I found out who left*), there are C1 heads which semantically 'fit': either QUEST can be placed in C1, transforming the embedded interrogative into a question act (which is then shifted into the true answer using Krifka 2001's TA shifter), or ANSW is placed in C1, transforming the embedded interrogative into the true answer directly. As such, C1 is projected in such cases, and ellipsis (sluicing) can take place.

## 5.9 Interim summary

I have argued that clausal ellipsis is dependent on the presence of a higher complementizer C1. In this section, I summarize some of the major proposals of this chapter so far.

**Bridge verbs** These verbs, such as *think, believe, say, tell, hope, suspect, suppose, guess*, can show fragment ellipsis, because they embed C1 which has the role of creating an assertion speech act.

- (610) a. Who ate the cookies? — I think John.  
 b. I think [<sub>CP1</sub> John [<sub>C1</sub> ASSERT] [<sub>CP2</sub> C2 [<sub>TP</sub> t ate the cookies]]]

To the extent that these verbs can embed interrogative complements, they can also show sluicing: *guess*, *tell*, and marginally *say* can do this. This is because these cases embed a C1 which takes the interrogative complement and translates it into a proposition which is the true answer to the question.

- (611) a. Someone ate the cookies, and John guessed/told me/?said who.  
 b. John guessed/told me/said [<sub>CP1</sub> who [<sub>C1</sub> ANSW] [<sub>CP2</sub> t C2 [<sub>TP</sub> t ate the cookies]]]

**Non-bridge verbs** When verbs such as *find out*, *remember*, *recall*, *know* embed interrogative complements, they show sluicing. This is because these cases embed the same answer operator in C1; alternatively, in non-veridical environments such as *want to find out*, they can embed true question acts (as McCloskey 2006 argues), and so can embed the C1 which types an embedded clause as a question act.

- (612) a. Someone ate the cookies, and John found out who.  
 b. John found out [<sub>CP1</sub> who [<sub>C1</sub> ANSW] [<sub>CP2</sub> t C2 [<sub>TP</sub> t ate the cookies]]]
- (613) a. Someone ate the cookies, and John wants to find out who.  
 b. John wants to find out [<sub>CP1</sub> who [<sub>C1</sub> QUEST] [<sub>CP2</sub> t C2 [<sub>TP</sub> t ate the cookies]]]

However, when these verbs embed declarative complements, or in the case of some non-bridge verbs which do not embed interrogative complements (such as *deny*), they do not show clausal ellipsis. This is because these structures lack C1; projecting it would be semantically superfluous, as these predicates embed simple propositions, neither speech acts nor questions which have been transformed into the true answers to that question.

- (614) a. Who ate the cookies? — \*I found out/deny/remember John.  
 b. I found out [<sub>CP2</sub> C2 [<sub>TP</sub> John ate the cookies]]  
 (no C1 to license ellipsis)

**Verbs embedding question speech acts** These verbs, such as *ask*, *wonder*, *inquire*, show sluicing, and do so because they embed a C1 head which types the clausal complement as a question speech act.

- (615) a. Someone ate the cookies, and John asked who.  
 b. John asked [<sub>CP1</sub> John [<sub>C1</sub> QUEST] [~~CP2~~ ~~C2~~ [~~TP~~ ~~t~~ ate the cookies]]]

**Matrix versus embedded exclamatives** Embedded exclamatives do not contain C1 (see 5.7.4 for evidence). As such, they do not elide. However, I assume that matrix clauses always contain C1, and so matrix exclamatives can elide.

- (616) a. What an idiot!  
 b. \*I can't believe what an idiot!
- (617) a. [<sub>CP1</sub> what an idiot [<sub>C1</sub> EXCL] [~~CP2~~ ~~t~~ ~~C2~~ [~~TP~~ he is t]]]  
 b. I can't believe [<sub>CP2</sub> what an idiot [<sub>TP</sub> he is]]  
 (no C1 to license ellipsis)

In the remainder of this chapter, I address some remaining issues concerning the structure of the left periphery in clausal ellipsis cross-linguistically.

## 5.10 Split CPs, ellipsis, swiping and spading

The interaction of the split-CP hypothesis and clausal ellipsis has already been investigated in some detail by Jeroen van Craenenbroeck (van Craenenbroeck 2004, 2010b). In his work, van Craenenbroeck proposes that both CP2 (i.e. the complement of C1), and TP (i.e. the complement of C2), can in principle elide.

Van Craenenbroeck's implementation is as follows. Assuming, following Merchant 2001, that the licensing of ellipsis by a particular head is due to the presence of a feature [E] on that head; and assume, again following Merchant, that this feature itself has features



which need to be checked, specifically [+Q, +Op].<sup>194</sup> Van Craenenbroeck assumes that the [E]-feature is first merged on C2, and that C2 itself can bear a [+Op] feature which checks the [+Op] feature on [E].

(618) (van Craenenbroeck 2010b chap. 5:(25), adapted)

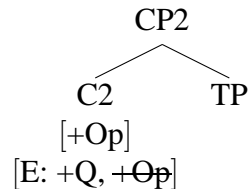

A *wh*-word can then be moved to [Spec, C2], to check the [+Op] feature on [Spec, C2]. This *wh*-word will contain a [+Q] feature, which checks the [+Q] feature on [E]. [E] is therefore fully licensed on C2, and can elide TP. (The *wh*-word then moves further, to [Spec, C1], to check C1's [+Q] feature.)

(619) (van Craenenbroeck 2010b chap. 5:(29), adapted)

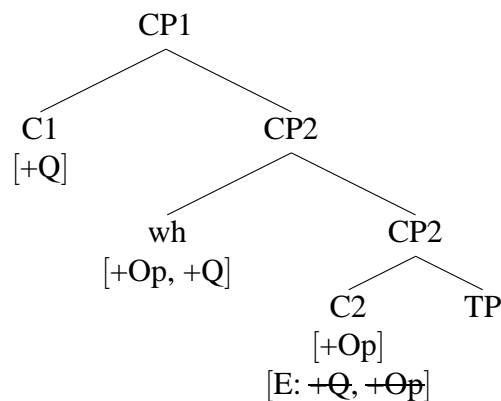

Van Craenenbroeck makes these moves to provide an account of *swiping* in English (sluicing with a remnant preposition, exemplified in (620a)) and *spading* in Dutch dialects (sluicing with a remnant demonstrative pronoun, exemplified in (620b)).

---

<sup>194</sup>This feature constellation is intended to be a way of encoding the idea that only the *wh*-words in constituent questions – i.e. only phrases which have a question semantics [+Q] and are operators [+Op] – prompt clausal ellipsis. The details clearly need to be changed if we want to also account for fragment answers, as Merchant 2004 and van Craenenbroeck & Lipták 2006 point out; exclamative sluicing is also perhaps not predicted, depending on whether one assumes a relative analysis of exclamatives (Rett 2011) or a question analysis (Zanuttini & Portner 2003). This will be discussed in more detail in section 5.12, where I will ultimately reject the notion that the [E]-feature itself has featural requirements.

- (620) a. John danced, but I don't know who with.  
 b. A: Jef ei gisteren iemand gezien. B: Wou da?  
       Jef has yesterday someone seen        who that  
       'A: Jeff saw someone yesterday. B: Who?'  
       (van Craenenbroeck 2010b chap. 1:(5), Wambeek Dutch)

In both these phenomena, only simple *wh*-words are allowed: complex *wh*-phrases are forbidden.<sup>195</sup>

- (621) a. \*John danced, but I don't know which student with.  
 b. (i) Wui da?  
       where that  
       'Where?'  
       (ii) \*Welken boek da?  
       which book that  
       (van Craenenbroeck 2010b chap. 3:(10), Wambeek Dutch)

Van Craenenbroeck's analysis of the interaction of ellipsis and the split CP is intended to capture this generalization. Van Craenenbroeck argues that, while simple *wh*-words are moved through [Spec, C2] to [Spec, C1], complex *wh*-phrases are base-generated in [Spec, C1], and only a null operator moves to [Spec, C2] in such cases.

---

<sup>195</sup>Although Hartman & Ai 2007 point out some counterexamples to this generalization in swiping; see below.

(622) (van Craenenbroeck 2010b chap. 4:(2b), adapted)

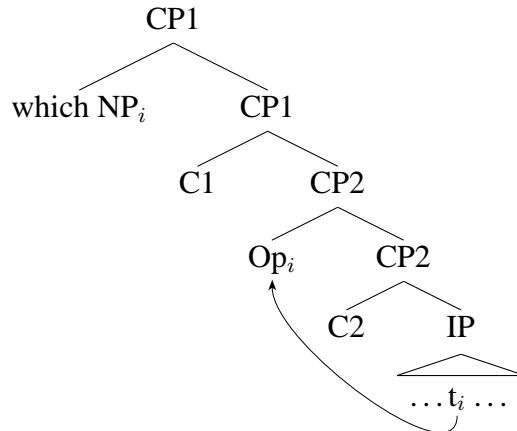

In cases with a complex *wh*-phrase, then, there is no [+Q]-marked phrase in [Spec, C2], but rather only an operator. As such, the [E]-feature in C2 has to move to C1 to be in a sufficiently local relationship with a [+Q]-marked phrase which can check the [E] feature's [+Q] feature.

(623) (van Craenenbroeck 2010b chap. 5:(28), adapted)

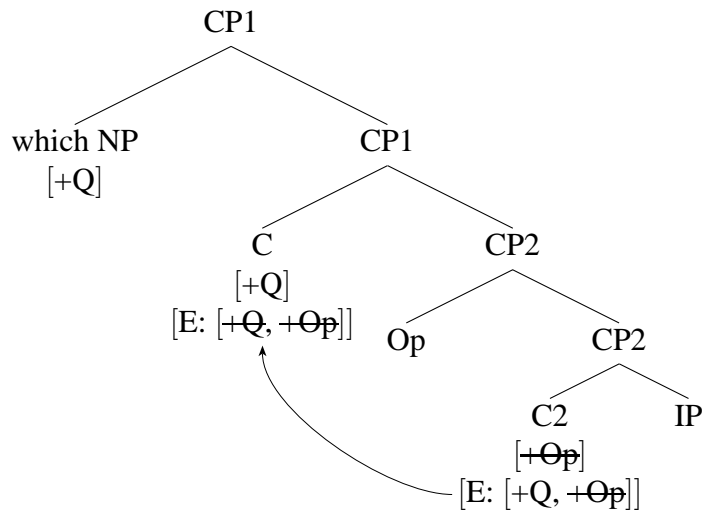

This predicts that simple *wh*-words prompt ellipsis of IP only: the [E]-feature can meet all its featural requirements on C2, so the [E]-feature stays on C2 and elides IP. However, in a case with a complex *wh*-phrase, CP2 is elided: the [E]-feature has to move to C1 to check all of its features, forcing C1's complement, CP2, to be elided. This accounts for the asymmetry between simple *wh*-words being allowed in swiping and spading (620) and

complex *wh*-phrases being barred in these constructions (621): the preposition (in swiping) or the demonstrative (in spading) can move into [Spec, C2], and it will be pronounced if only IP is elided (i.e. if a simple *wh*-word has moved). However, in the case where there is a complex *wh*-phrase, CP2 is elided, and erases the preposition or demonstrative as well, accounting for the ungrammaticality of cases like (621). I illustrate this for swiping below, referring the reader to van Craenenbroeck 2010b for the full details, and discussion of spading.

- (624) a. He danced. – Who with?  
           [<sub>CP1</sub> who C1 [<sub>CP2</sub> with C2<sub>E</sub> [<sub>IP</sub> ~~he danced t~~]]]
- b. He danced. – \*Which person with?  
           [<sub>CP1</sub> which person C1<sub>E</sub> [<sub>CP2</sub> ~~with C2~~ [<sub>IP</sub> ~~he danced t~~]]]

This proposal is of course at odds with my argument in this chapter, that only C1 licenses ellipsis. Given the evidence presented in the preceding sections, I argue that we have seen that C2 does not have the power to license ellipsis, even if it attracts a *wh*-word to its Spec which could (presumably) check the [+Q] feature.<sup>196</sup> However, in these cases of sluicing plus something (a preposition or demonstrative), we do want to know which position the ‘something’ has moved into, and van Craenenbroeck’s proposal that it moves into an unelided [Spec, C2] tells us. We also want to understand whether there is an alternative way of understanding the restriction to simple *wh*-phrases in these structures.

A full analysis of swiping and spading is beyond the scope of this dissertation. However, I would point out that Hartman & Ai 2007 propose an alternative explanation for the degradation of complex *wh*-phrases in swiping constructions.<sup>197</sup> A complex *wh*-phrase is D[iscourse]-linked (Pesetsky 1987); a phrase like *which NP* presupposes that some NP is

---

<sup>196</sup>One could perhaps argue that in the constructions I have looked at which do not sluice – unconditionals, relatives, and embedded exclamatives – a [+Q] feature is not present. I will discuss some problems with encoding this behavior in featural terms in section 5.12.

<sup>197</sup>But see also van Craenenbroeck 2010b:sec. 7.3.4 for a reaction to this proposal.

in some sense given in the discourse. However, swiping is only licit if there is *not* an antecedent in the discourse for the *wh*-word and preposition, that is, if it is new information (see Hartman & Ai 2007 for an explanation of this fact in terms of the Focus requirement on swiping).

- (625) a. He danced, but I don't know who with.  
b. He danced with someone, ??but I don't know who with.

These requirements conflict. Complex *which NP* phrases require a presupposed set NP, but swiping requires that there not be such a presupposed set, accounting for the degradation of (626).

- (626) \*He danced, but I don't know which student with.

Hartman & Ai 2007 point out that there are a number of cases where, in fact, context already provides a given set NP, and in these cases, complex *wh*-phrases in swiping improve:

- (627) (Hartman & Ai 2007's (31))
- a. He fought in the civil war, but I don't know which side for.
- b. Pierre is an illegal immigrant. He's originally from France, but came here from Canada. He'll definitely be deported, but it's not clear which country to.
- c. A: He plays shortstop.  
B: Which team for?
- d. It appears to have been translated, but I can't tell what language from.

So I argue, following Hartman & Ai 2007, that the restriction to simple *wh*-words in swiping should not actually be given a syntactic source.

The remaining question is whether we need CP2 to go unelided in swiping/spading to allow a position for the preposition/demonstrative to move into. I think the answer is no: we can hold to a view in which it is always CP2 which is elided (i.e. C1 is always the

ellipsis-licensing head). I will offer a sketch of an analysis here, although I will have to leave elaboration to future work.

As van Craenenbroeck 2004, 2010b, Hartman & Ai 2007 point out, the preposition in swiping and the demonstrative in spading must always be focused.

- (628) a. He's dancing, but I don't know who WITH/\*WHO with.  
 b. Z'eid iemand gezien, mo kweet nie wou DA / \*WOU da.  
 she.has someone seen but I.know not who that who that  
 'She saw someone, but I don't know who.' (van Craenenbroeck 2010b  
 chap. 3: (12b), Wambeek Dutch)

Hartman & Ai 2007 analyze cases of swiping as movement of a PP to a Focus position, followed by subextraction of the *wh*-word to a higher position.

- (629) [CP who<sub>i</sub> [FocP [PP with t<sub>i</sub>]<sub>j</sub> [~~IP he was dancing t<sub>j</sub>~~]]]

This is another case of focus movement, which is disallowed in English outside of elliptical constructions. Given this, I believe that this can be analyzed as the same sort of focus movement which I have argued takes place in fragment answers. The *wh*-word moves to [Spec, C1] in narrow syntax, as it normally would. But then the focused PP also has to move to escape ellipsis, and it moves via the exceptional PF movement discussed in 4. This movement will only move a remnant to the very edge of the ellipsis site and no further (Boone 2013), so we get a 'tucking-in' effect.

(630) He was dancing – Who with?

(631) Narrow syntax:

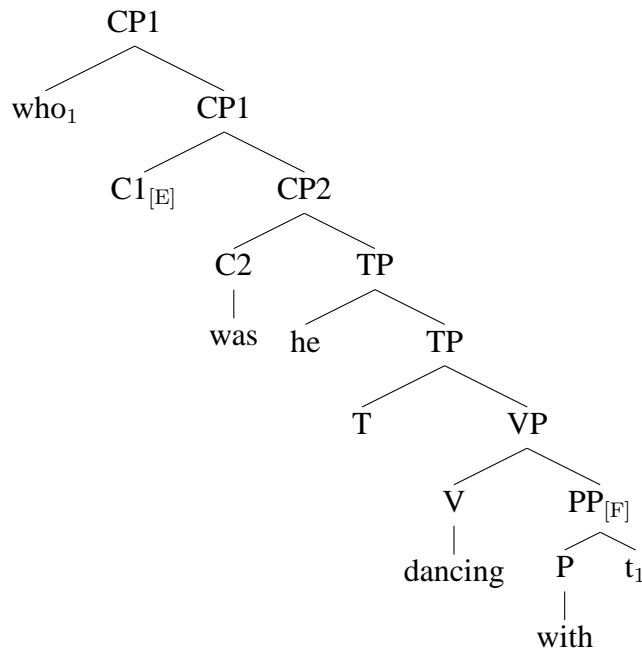

(632) After PF-movement of the focused PP:

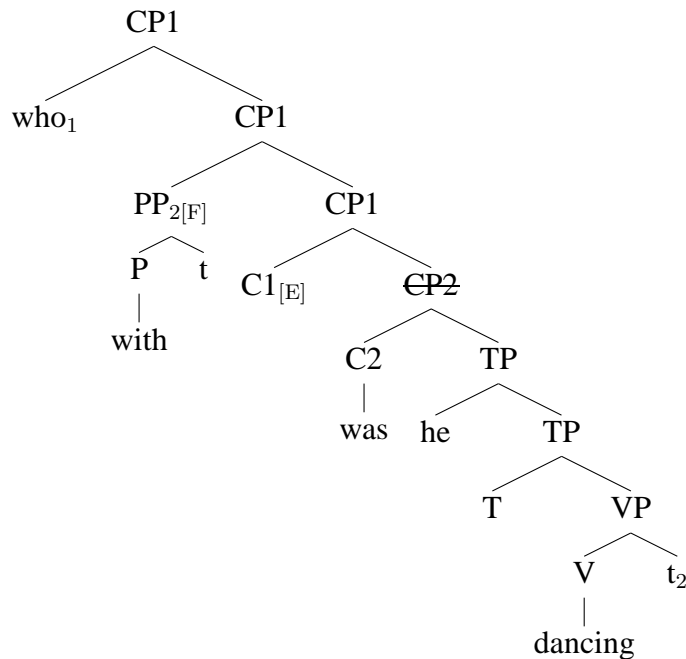

This is only a sketch of how we might understand swiping in an analysis in which all of the left periphery of the clause, except CP1, is elided. Elaboration of this proposal, and in

particular extension to spading, must be left to future work. However, I hope to have shown that such an approach at least seems possible in theory, and that the conclusion that C1 is the head which licenses ellipsis is not endangered by van Craenenbroeck 2004, 2010b's analysis of swiping and spading.

Having said all this, there are some languages in which complementizers do co-occur with fragment answers, which is perhaps unexpected if C1 is the licensing head for ellipsis. In the next section, I investigate this cross-linguistic variation.

### 5.11 The presence or absence of a complementizer

In embedded fragments in English, German and Dutch, the presence of a complementizer is ungrammatical. The data in (633) are from Vicente 2013:sec. 5.3, slightly adapted.

- (633) Who is going to receive a stipend?
- a. I think (\*that) Bob.
  - b. Ich glaube (\*dass) Bob. [German]
  - c. Ik denk (\*dat) Bob. [Dutch]

In terms of the analysis being developed here, we can understand this as telling us that C2 is realized as *that/dass/dat* in these languages. This complementizer is elided when it occurs under C1. This is shown below for English.

- (634)  $[_{TP} I [_{VP} think [_{CP1} Bob C1 \text{---} [_{CP2} \text{that} [_{TP} t \text{ is going to receive a stipend} ]]]]]$

However, the complementizer is allowed in languages such as Spanish, Polish and Hungarian, as shown by the below data (again from Vicente 2013).

- (635) Who is going to receive a stipend?
- a. Creo que Bob. [Spanish]  
I.think that Bob
  - b. Myślę że Bob. [Polish]



c. Gondolom hogy Bob.

[Hungarian]

This is not immediately expected on the current analysis; some principled way is required to distinguish English, German and Dutch on the one hand from Spanish, Polish and Hungarian on the other.

Two theories present themselves to explain this data. One is that C1 is the ellipsis-licensing head everywhere, and what the data in (635) show is that there is an even higher complementizer position in Spanish, Polish and Hungarian. This position selects CP1. It is the material in this position, even higher than CP1, which is realized in these languages above the position to which the fragment moves. The second theory is that, in some languages, a head lower than either C1 or C2 licenses ellipsis, and it is C2 which is being realized as a complementizer in (635).

In this section, I will argue that in fact, both of these theories are correct, but for different languages. I will present evidence that the first theory, in which an even higher complementizer position selects CP1, is correct for languages like Spanish. However, in a language like Hungarian, there is evidence that in fact a projection lower than C1 can license ellipsis, and so the second theory explains the complementizer facts in that language.

### 5.11.1 Spanish: a very high complementizer

Here is the proposed structure for Spanish embedded fragments. The existence of a higher position Sub has already been proposed in the cartographic program by Haegeman 2006a, from whom I take the name.<sup>198</sup>

---

<sup>198</sup>I don't commit myself to whether Sub is projected in English, Dutch and German, or not. If Sub is projected, it would be required on my analysis that Sub not be realized overtly in these languages, as that would predict the existence of elliptical fragments like *\*I think that John* in English (and the equivalents, with pronounced complementizers, in Dutch and German).

(636) a. Creo que Bob.

I.think that Bob

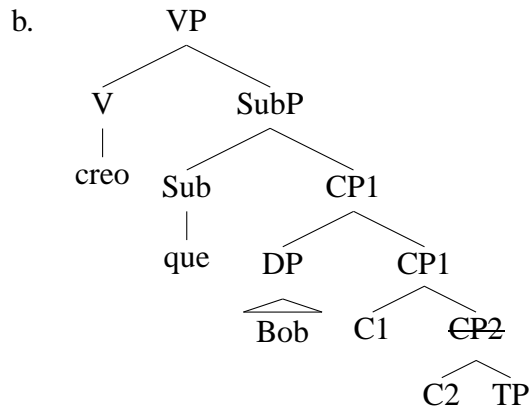

Such a structure implies that C1 is the ellipsis-licensing head in Spanish. I believe that is the correct result, on the basis of the below contrasts, repeated here from (481).

(637) a. ¿Quién robó las joyas?

who stole the jewels

'Who stole the jewels?'

b. Creo / supongo / me imagino / pienso que tu hijo.

I.believe I.suppose I.imagine I.think that your son

'I believe/suppose/imagine/think your son.'

c. #Lamento / sé / me sorprende / me desagrada (que) tu hijo.

I.regret / I.know / me it.surprises / me it.displeases that your son

Here, we see that the verbs which embed fragments in Spanish are of a piece with those which embed fragments in English. The more 'transparent' bridge verbs – verbs which plausibly embed speech acts – can embed fragments; verbs which are rather relations between individuals and propositions (rather than speech acts) do not embed fragments. On the current analysis, this implies that C1 is responsible for clausal ellipsis in Spanish; only those predicates which embed speech acts – that is, which embed a subordinate clause which contains C1 – can embed fragments.

Further reason to believe that there is a higher complementizer position in Spanish which can select for a clause containing C1 comes from the fact that the complementizer *que* can introduce an embedded intensional question, but not an embedded extensional question. That is, verbs like *ask*, *wonder* can select for *que* in a position above the *wh*-word, but verbs like *know*, *find out* cannot (Suñer 1991, 1993).

(638) Sue preguntó / se preguntó que cuántas charlas planeaban los estudiantes.

Sue asked wondered QUE how many talks plan.IMPF the students  
 ‘Sue asked/wondered how many talks the students were planning.’

(639) Sue sabía / explicó (\*que) cuántas charlas planeaban los estudiantes.

Sue knew explained QUE how many talks plan.IMPF the students

We could interpret this as *que* being a realization of C1. However, if C1 has the job of creating a speech act, we probably want to say that it is silent. Presumably C1 is present in matrix utterances (turning them into speech acts); but this *que* does not appear in matrix questions in Spanish.

(640) ¿(\*Que) cuántas charlas planeaban los estudiantes?

QUE how many talks plan.IMPF the students  
 ‘How many talks are the students planning?’

Rather, this data is consistent with *que* being in a position which is only present in subordinate clauses, and which then selects C1. This is why Haegeman 2006a gives this position the name SubP; it is a position which is only present in subordinate clauses, never in matrix ones. We could then analyze the data in (638), (639) as indicating that filled Sub can select for a C1 which contains QUEST. If filled Sub in general selects, or can select, for a filled C1, we understand why complementizers appear above embedded fragments in Spanish; Sub (pronounced *que*) selects for C1, C1 then elides the rest of the clause. Structures which do not contain C1 (such as clauses embedded by *lamentar* ‘regret’, etc.) cannot undergo ellipsis, and so do not embed fragments.

### 5.11.2 Hungarian: a low position for ellipsis remnants

We could take the solution proposed for languages like Spanish above over to cases like Hungarian. However, there are reasons to believe that another solution might be more fruitful, namely that in Hungarian, it is a lower projection which is responsible for licensing the ellipsis. One reason to believe this is that the contrast between verbs which embed speech acts, and verbs which do not, which is present in English and Spanish, is *not* present in Hungarian. In Hungarian, verbs in the same class as *know* and *find out* can in fact embed fragments.

- (641) Tudtam, hogy János meghívott néhány embert, de nem tudtam, hogy  
knew-1SG that János PV-invited some people-ACC but not knew-1SG that  
mindenkit [e]  
everyone-ACC  
'I knew that János invited some people, but I didn't know that he invited every-  
one.'  
(literally: 'I knew that János invited some people, but I didn't know that every-  
one'; van Craenenbroeck & Lipták 2006's (33). (PV = preverb))

- (642) (Anikó Lipták p.c.)  
a. Ki evett csokoládét?  
who ate chocolate  
'Who ate chocolate?'  
b. {Kiderült / sajnálom / csodálkozom / tudom} hogy Béla.  
turned.out.3SG regret.1SG am.surprised know.1SG that Béla

An even more striking difference between languages like English and languages like Hungarian is the ability to elide relative clauses as long as there is a focused remnant, as discussed by van Craenenbroeck & Lipták 2006.

- (643) Nem ismerem azt, akit Zsuzsa meghívott, de ismerem  
 not know-1SG that-ACC whom-ACC Zsuzsa invited but know-1SG  
 azt, akit MARI [e].  
 that-ACC REL-whom-ACC Mari  
 ‘I do not know the person who Zsuzsa invited, but I know the person who Mary  
 did.’  
 (more literally: ‘I do not know the person who Zsuzsa invited, but I know the  
 person who Mary’; van Craenenbroeck & Lipták 2006’s (10))
- (644) Péternek AZT A FOTÓT mutattam meg, amit ANNÁNAK [e].  
 Péter-DAT that-ACC the photo-ACC showed PV REL-ACC Anna-DAT  
 ‘The photo I showed to Peter was the one that I showed to Anna.’  
 (more literally: ‘I showed Peter-DAT the photo that Anna-DAT’; van Craenen-  
 broeck and Lipták’s (13))

This looks like clausal ellipsis (as opposed to, say, VP ellipsis) for a number of reasons. van Craenenbroeck & Lipták 2006 elaborate on a number of arguments for this; one that we can see from (644) is that any argument (not just the subject, as in VPE) can be the focused remnant in this form of ellipsis.

We have assumed that C1 licenses ellipsis in English; relative clauses, and the complements of verbs like *know*, *find out* (when these embed declaratives), cannot undergo clausal ellipsis. But in Hungarian, they can. This suggests that a projection lower than C1 is licensing ellipsis in Hungarian. This is what van Craenenbroeck & Lipták 2006 propose: the remnant in such constructions is proposed to raise to a Focus projection whose complement is elided. The presence of this projection is independently motivated, as focused phrases move to such a position in Hungarian even outside of elliptical constructions (Brody 1990). So constructions like (645a) have the syntax in (645b).

- (645) a. Tudtam, hogy János meghívott néhány embert, de nem tudtam,  
 knew-1SG that János PV-invited some people-ACC but not knew-1SG  
 hogy mindenkit [e]  
 that everyone-ACC  
 ‘I knew that János invited some people, but I didn’t know that he invited  
 everyone.’

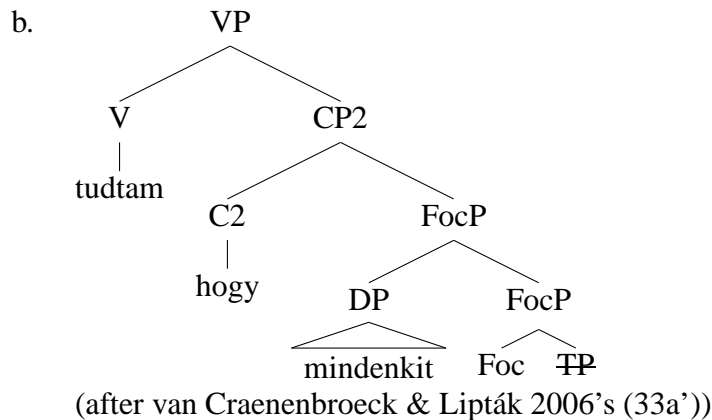

Finding that a head lower than C1 can license ellipsis in Hungarian (but not in English or Spanish, say) suggests that there is parametric variation between languages concerning which heads license ellipsis in which languages. In the next section, I discuss how this parametric variation should be analyzed.

## 5.12 The licensing of ellipsis and the [E]-feature

If it is correct that there is variation between languages in which heads license clausal ellipsis, we want to have some understanding of why this is. van Craenenbroeck & Lipták 2006 put forward a generalization which is intended to capture the distinction between clausal ellipsis in Hungarian (which allows for a very wide set of types of clausal ellipsis, including fragment ellipsis in relative clauses and under non-bridge verbs, as discussed above) on the one hand, and English (which, I have argued, only allows for clausal ellipsis in cases where the higher complementizer C1 is in the structure) on the other.

(646) *The wh-slruicing correlation* (van Craenenbroeck & Lipták 2006's (29))

The syntactic features that the [E]-feature has to check in a certain language are identical to the strong features a *wh*-phrase has to check in a regular constituent question in that language.

van Craenenbroeck & Lipták 2006's argument goes like this. It is well known that in Hungarian, *wh*-phrases do not target [Spec, C] but rather the lower Focus position discussed above (Brody 1990). This is the position which van Craenenbroeck & Lipták 2006 argue is also the landing site for remnants in Hungarian clausal ellipsis; and this seems to be clearly supported by the data discussed in 5.11.2. On this basis, van Craenenbroeck & Lipták 2006 argue that *wh*-phrases, and focus phrases, only have to check a feature [+Op(erator)] in Hungarian. This is the feature which the [E]-feature has to check in Hungarian. This is done by means of attracting a phrase endowed with [Op] to the Spec of the FocusP, the [E]-feature being merged onto the Focus head. The syntax is illustrated below (repeated and elaborated from (645b)).

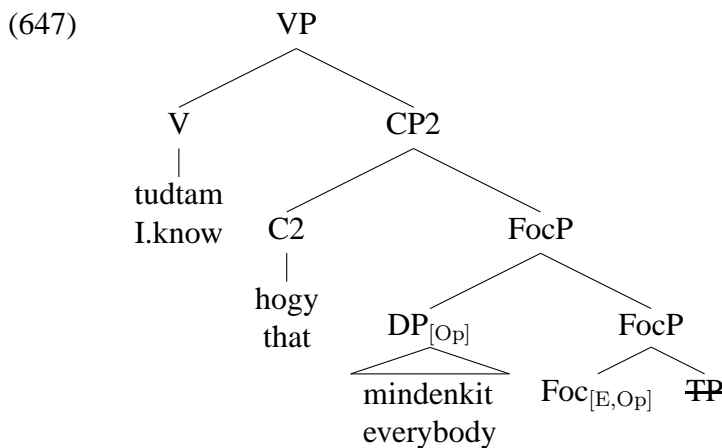

The operator feature of [E] is checked in a local relationship with the focused phrase *mindenkit*, which is attracted out of the TP.

By contrast, in English, van Craenenbroeck & Lipták 2006, following van Craenenbroeck 2004, argue that *wh*-phrases (in constituent questions) have to satisfy both an [Op] feature and a [ClauseType] feature. The need to satisfy this latter feature is why *wh*-phrases ap-

appear in the Spec of a complementizer phrase in English: it is one of the complementizer phrases, in our terms (and van Craenenbroeck 2004's) C1, which bears a [ClauseType] feature, and the *wh*-phrase has to raise to C1 to check its [ClauseType] feature in the required local relation. C2, van Craenenbroeck and Lipták argue, bears the [Op] feature, so the *wh*-phrase moves to the Spec of C2 to check [Op] before moving on to the Spec of C1 to check [ClauseType].

(648)

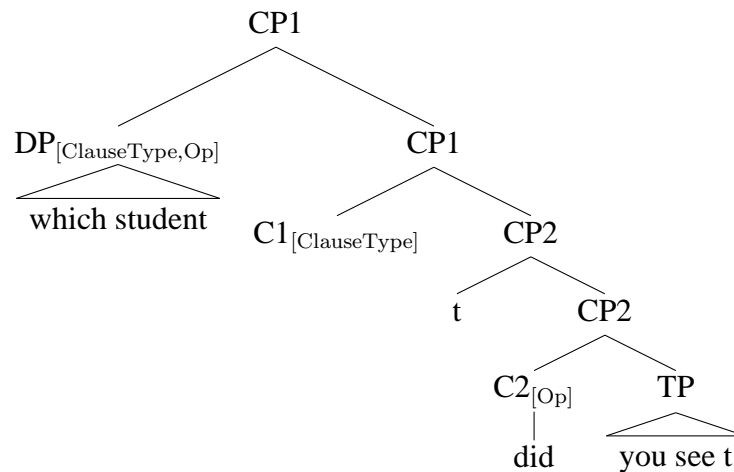

Following the *wh*-sluicing generalization, the [E] feature also has to check [ClauseType] and [Op]. On van Craenenbroeck & Lipták 2006 and van Craenenbroeck 2004's proposals, the [E] feature starts on C2. If C2 has an [Op] feature (i.e. attracts an operator to its Spec), then the [Op] feature on [E] can be checked here. The [E]-feature then moves to C1, where there is a [ClauseType] feature. This feature checks the matching [ClauseType] feature on E. The syntax of English sluicing, and of fragment answers, on this view is illustrated below.



(649) a. John kissed a student, and I know which student ~~he~~ kissed.

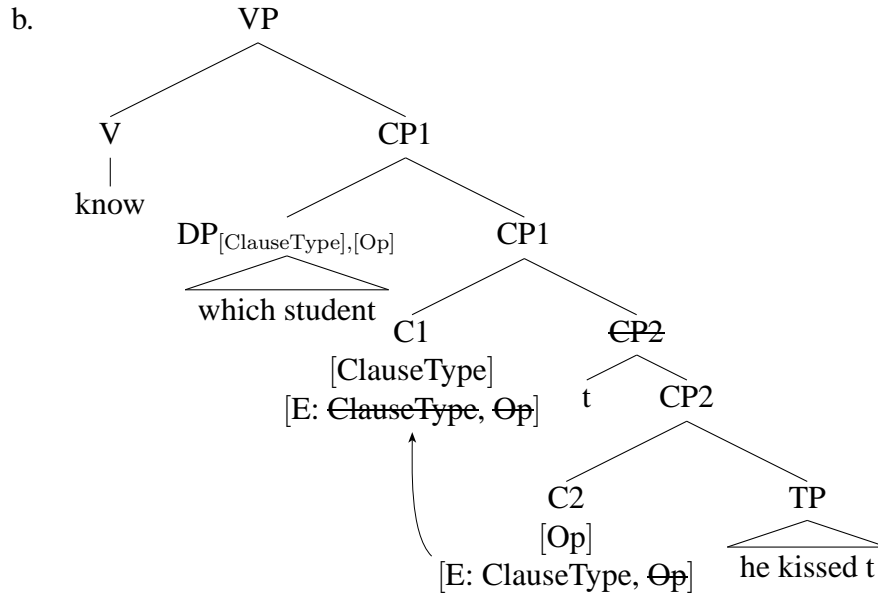

(650) a. A: Who did John kiss? B: I think Mary.

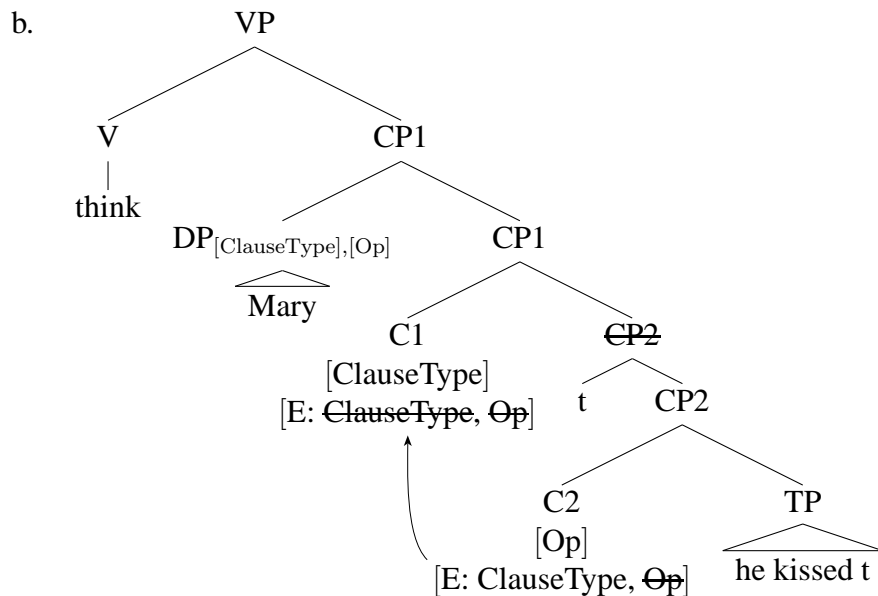

In this way, van Craenenbroeck & Lipták 2006 account for the distinction between Hungarian and English. The Hungarian version of the [E]-feature is content to check only an [Op] feature. As such, clausal ellipsis in Hungarian can appear anywhere that an operator-binding relationship is set up. As focus movement is independently available in Hungarian, including inside relative clauses and under non-bridge verbs, this focus movement is enough to check the [E]-feature's requirements, and ellipsis is possible in any sort of focus

movement construction in Hungarian. By contrast, in English, the [E]-feature is required to be in a local checking relationship with a [ClauseType] feature. This requires it to be on C1, and any ellipsis remnant to have moved to [Spec, C1]. The set of cases in which clausal ellipsis is licit in English is therefore a smaller set than in Hungarian; basically, only those cases which involve C1.

That, of course, is the argument that has been being made throughout this chapter – that clausal ellipsis (in English) requires C1. As such, there is *prima facie* reason to believe that van Craenenbroeck & Lipták 2006's proposal is correct. However, I believe van Craenenbroeck & Lipták 2006's implementation of the proposal is not quite right, and I discuss here some problems with it.

The first is a simple one: it is not clear what it means to say that the [E]-feature itself has features. van Craenenbroeck & Lipták 2006 inherit this issue from Merchant 2001, who uses the same technology. However, I am unaware of other cases in which we want to say that a feature can itself have features which are in need of being checked.

The second problem is that the relevant feature in English cannot be [ClauseType], at the risk of allowing cases like (651).

- (651) Who ate the cookies?
- a. \*I found out John ~~that t ate the cookies~~.
  - b. \*I'm sad John ~~that t ate the cookies~~.
  - c. \*I didn't know John ~~that t ate the cookies~~.

The argument that has been made in this chapter is that the embedded clauses in (651) lack C1, and cannot elide for this reason. But they plausibly have clause types (i.e. are marked as declarative); and this is presumably syntactically encoded somewhere, perhaps on C2. But in that case, if the [E] feature wants to check [Op, ClauseType] features, then that should be available to it in the cases in (651) (by checking [ClauseType] on C2), and these clauses should be able to show ellipsis, contrary to fact.

We could refine the feature requirements of the [E]-feature in English by saying that [E] wants to check, not a [ClauseType] feature, but something like a [SpeechAct] feature. However, if this were true, then the cases of sluicing below should *not* be good.

- (652) Someone ate the cookies. . .
- a. and I found out who.
  - b. and I know who.
  - c. and I confirmed who. etc.

As argued in section 5.8, these cases contain C1 (which plays the role of an Answer operator, creating a ‘true answer’ proposition for the verb to embed), but do not embed speech acts. If the [E]-feature had to check a feature [SpeechAct], then cases like (652) should not be possible.

We could alternatively suggest that in cases like (651), the embedded clauses are not in fact marked for clause type (giving ‘clause type’ a more semantic construal). But in that case, we would have to say that the elided clauses in (652) (*I found out who ate the cookies, etc.*) are marked for (interrogative) clause type (and so have a [ClauseType] feature which can check the [E]-feature’s feature), but that the embedded clauses in (651) (*I found out that John ate the cookies, etc.*) are not marked for (declarative) clause type, which seems unlikely. There does not seem to be a principled way of cleaving a distinction between these two cases just by making reference to clause typing.

From facts like these, I argue that the determinant for ellipsis is simply the presence or absence of C1, whatever features it happens to have or whatever role it happens to be playing (creating a speech act, or creating a ‘true answer’ as argued in section 5.8). The determinant for ellipsis is not the presence or absence of a [ClauseType] or [SpeechAct] feature which [E] has to check.

The third problem I wish to raise is that, as argued in chapter 4, there is no clear evidence that fragment movement in English is feature-driven, or a case of operator movement.

It does not seem to be interpreted, and so does not seem like a clear case of operator-variable binding. Rather, I have argued that fragment movement is a last-resort PF-only procedure. Given this, it is not clear that the [E]-feature has to check an [Op] feature, or that operator movement is a necessary component of clausal ellipsis.

For all these reasons, I do not think that encoding in featural terms the requirement that ellipsis requires C1 in English but does not in Hungarian – that is, locating the parametric difference between English and Hungarian in terms of what features the [E]-feature needs to check – is the correct way of capturing the generalization. There is no way of consistently defining the features which the [E] feature would need to check in English in order to rule in sluicing under factive verbs, but rule out fragment movement in the same environment. In addition, it is not clear that the exceptional focus movement which takes place in English fragments is operator movement – that is, there is no clear evidence for the [E] feature in English having the feature [Op].

I argue, rather, that the parametric difference between English and Hungarian is simply one of which head licenses ellipsis. There is simply a lexical difference in which heads bear the [E]-feature: in English, C1 does, while in Hungarian, Foc does. The differences between English and Hungarian follow from this. Foc is assumed to always be present just under a complementizer in Hungarian, and so a wide variety of elliptical constructions are licit in Hungarian (relative sluicing, fragments under verbs like *know*, etc.) By contrast, C1 is not always present in English, and in the environments in which C1 is not present, clausal ellipsis is also ruled out.

This may seem less satisfying than van Craenenbroeck & Lipták 2006's *wh*-sluicing correlation, and intuitively it is less satisfying. However it should be noted that van Craenenbroeck and Lipták's proposed generalization was an explanandum, not an explanation. The generalization is essentially a stipulation which says that the [E]-feature and *wh*-movement are driven by the same set of features, but there is no explanation for why this correlation should hold. This is not a criticism of van Craenenbroeck and Lipták,

who do not mean the generalization to be proposed as an explanation; rather, it is a cross-linguistic generalization whose etiology should be sought. However, I have argued above that the generalization does not actually hold: interrogative *wh*-movement is possible in the complement of *found out* or *know*, but fragment ellipsis is not, suggesting that there cannot be a perfect match between the featural requirements of interrogative *wh*-movement and the featural requirements of clausal ellipsis.

I argue that removing the featural requirements of the [E]-feature is actually a positive step in a number of ways. Firstly, as mentioned above, it is unclear what it means for a feature to have features. But in addition, removing the featural specification of the [E]-feature, and saying that there is simply cross-linguistic lexical variation in the heads on which [E] can appear, has the benefit that the [E]-feature can be used for the purpose it was originally intended: being a feature that licenses *all* forms of ellipsis. That is, in English, the inventory of heads which can bear the [E]-feature might be as below.

- (653) a. C1: I think [John C1 ~~ate the cookies~~] [clausal ellipsis]  
 b. v: John has been promoted, but Mary hasn't been [<sub>VP</sub> v ~~promoted~~] [VP ellipsis]<sup>199</sup>  
 c. Num: I ate two apples and you ate [<sub>NumP</sub> three Num ~~apples~~] [NP ellipsis]<sup>200</sup>

Languages which lack VP ellipsis would not put [E] on v; languages like Hungarian which have 'focus sluicing' would put [E] on Foc; and so on.

This would require a loosening of the semantics of the [E]-feature as it was proposed in Merchant 2001, viz.:

- (654)  $[[[E]]] = \lambda p.p$ , iff  $p$  is e-GIVEN [or QUD-GIVEN, AW]; otherwise undefined.

---

<sup>199</sup>Aelbrecht 2009 argues that v is the relevant head for VP ellipsis. Other analyses exist, but there is general agreement that some head in the verbal domain is required to license VP ellipsis.

<sup>200</sup>Again, whether Num is the correct head here is up for debate, but again, the point is just that some head in the nominal domain licenses NP ellipsis.

A first problem, as discussed in section 3.6.1, is that the denotation of the [E]-feature as shown in (654) is actually not technically correct. It contains a presupposition that a particular proposition  $p$  is e- or QUD-GIVEN. However, propositions cannot be e- or QUD-GIVEN – this is rather a property which holds of phrase markers. Given this, the result of combining of [E] with a phrase in fact has to be given as a syncategorematic rule of the form in (655).

(655)  $\llbracket [E] \rrbracket (\llbracket X \rrbracket) = \llbracket X \rrbracket$ , iff X is e- or QUD-GIVEN; otherwise undefined.

Syncategorematic rules are to be dispreferred, as they represent a departure from strict compositionality.

More crucially, however, if [E] could be present on a number of different heads, so distinct from each other as (e.g.) C2, v, Num, and Focus, then we would certainly have to abandon a unitary semantics. As argued extensively in chapter 4, the semantic condition governing the availability of clausal ellipsis (here argued to be QUD-GIVENness) differs from that which governs the availability of VP ellipsis (as noted by Jacobson 2013). It's also clear that NP ellipsis must be governed by a quite different antecedence condition from clausal ellipsis.

In addition, the focus movement which Hungarian shows cannot be governed by QUD-GIVENness, at least not when it appears in relative clauses like the below.

(656) Kornél AZT A LÁNYT hívta meg, akit ZOLTÁN [e]

Kornél that.ACC the girl.ACC invited PV REL Zoltán  
 'The girl who Kornél invited was the one who Zoltán did.'

(literally: Kornél invited the girl that Zoltán [e]; van Craenenbroeck & Lipták 2006's (1))

Consider the anatomy of the elided clause here:<sup>201</sup>

(657)  $[_{CP} \text{ who}_1 [_{FocP} \text{ Zoltán}_2 [_{TP} t_2 \text{ invited } t_1 ]]]$

The clause which is elided here is the TP. However, this clause has two gaps in it. We have been assuming here that the moved Focus fragment is interpreted in its base position. We can assume also, following the copy theory of movement and Fox 1999's Trace Conversion algorithm, that the lower trace of movement is interpreted as a definite determiner combined with a variable, so that the semantics of the TP, and its focus-semantic value, are as below:

(658) a.  $[[TP]] = \text{Zoltán invited the } x$   
 b.  $[[TP]]^F = \{\text{Zoltán invited the } x, \text{ Mari invited the } x, \text{ Béla invited the } x, \dots\}$

The union of the focus-semantic value of TP is therefore the proposition shown in (659).

(659)  $\cup [[TP]]^F = \exists y. y \text{ invited the } x$

But the above is not in a mutual entailment relationship with the Question under Discussion in a case like (656). In such a case, the QUD is presumably something like 'Who did Kornel invite?', and the union of this question is  $\exists x. \text{ Kornel invited } x$ . So it does not seem as if QUD-GIVENNESS holds in these cases.<sup>202</sup>

I conclude from all of this that the semantics of ellipsis should be divorced from the [E]-feature. This is also a conclusion which has been proposed for independent reasons in recent work by Kyle Johnson (Johnson 2013a,b). Johnson argues that the [E]-feature does not in fact place a particular semantic requirement on its complement. Rather, what the [E]-feature does is license a relaxation of the usual linearization requirements which are imposed on phrase markers. Specifically, if there exists material which would normally

---

<sup>201</sup>The construction in (656) is an antecedent-contained deletion structure. I have assumed that the usual technique (Sag 1976, Kennedy 1997, Fox 2002) of QR'ing the head *the girl* out of the antecedent and late-merging *who Zoltán [e]* with this head solves this problem. This is orthogonal to our concerns here.

<sup>202</sup>e-GIVENNESS does, however: it may be that e-GIVENNESS is the correct antecedence condition for Hungarian focus ellipsis.

be linearized to the right of the head bearing the [E]-feature, then the [E]-feature relaxes the requirement that the material be linearized in that position. One way in which that requirement can be relaxed is via ellipsis. But Johnson argues that another way in which it can be relaxed is via deletion of a moved copy. That is, Johnson is pursuing the goal set forth in Lobeck 1995 of unifying the syntax of the [E]-feature, which licenses ellipsis, and principles like the Empty Category Principle (Chomsky 1986, Rizzi 1990 a.m.o.), which licenses ‘silent elements’ (e.g. traces, *pro*) in a broader sense. In this connection, it is interesting to note that those predicates which allow the embedding of fragments and the ellipsis of the rest of the clause are also those which most easily allow subject extraction.

- (660) Who ate the cookies?
- a. Mary {thinks/believes/was told/suspects/said} John.
  - b. \*Mary {whispered/sighed/quipped} John.
  - c. ??Mary {found out/confirmed} John.
  - d. \*Mary {is proud/is surprised} John.
- (661) a. Who {do you think/believe/suspect/were you told/did you say} [t ate the cookies]?
- b. \*Who did you {whisper/sigh/quip} [t ate the cookies]?
  - c. ??Who did you {find out/confirm} [t ate the cookies]?
  - d. ??Who are you {proud/surprised} [t ate the cookies]?

If Johnson (following Lobeck 1995) is right to unify the ECP and the ellipsis-licensing [E]-feature, and furthermore is right to suggest that the common factor is licensing otherwise forbidden linearizations (such as spelling out a DP in a position higher than its Merge position), then this would be expected. C1 is present in (660a) and (661a), and can bear the [E]-feature, which licenses both clausal ellipsis and extraction of the subject. By contrast, the (b, c, d) cases above lack C1, lack the [E]-feature, and both ellipsis and subject extraction are degraded, because the [E]-feature is responsible for licensing both.



It is outside the scope of this dissertation to explain these patterns fully and attempt a full unification of the [E]-feature and ECP effects along the lines proposed by Lobeck and Johnson. However, the correlation in (660) and (661) is at least suggestive that an approach in which there is just one [E]-feature, whose role is to license silence or an otherwise altered linearization, is on the right track. However, once this move is made, it becomes even clearer that the semantics of ellipsis should be divorced from the [E]-feature. If, for example, the [E]-feature on C1 is licensing subject extraction in cases like (661a), we do not want the [E]-feature to enforce QUD-GIVENNESS, or indeed any form of givenness at all, on the clause it combines with.

Rather, I propose that we envision the semantic condition on clausal ellipsis as a general condition on recoverability of deletion. Ellipsis, and perhaps silence in general (traces, *pro*, etc.) is handled on the syntactic/linearization side by the [E]-feature, but, as is well known, material which goes unspoken must also be recoverable by the hearer (a point made by Fiengo & Lasnik 1972 among others). I propose that QUD-GIVENNESS is the condition which makes a CP recoverable.

(662) A CP is Recoverable iff it is QUD-GIVEN, that is, iff there exists a  $Q$  on the QUD stack such that  $\bigcup Q \Leftrightarrow \bigcup [[CP]]^F$ .

There will be other notions of recoverability for other unspoken constituents. A VP, for example, may be recoverable if it meets the condition in Rooth 1992a. And in languages which genuinely seem to allow TP ellipsis (that is, languages like Hungarian which allow relative clause ellipsis, as opposed to English, which only allows CP2 ellipsis on the account proposed here), the condition may be something else: perhaps e-GIVENNESS.

This reasoning is extensible beyond cases of ellipsis, too. If movement is considered a kind of silence – deletion of a lower copy – then the failure to speak a copied DP in its base position might be licensed by the [E] feature, and recoverable, not by any semantic consideration as such, but just by the fact that a copy of that same DP is pronounced elsewhere

in the sentence. And in languages which have agreement-licensed *pro*-drop, the notion of recoverability might be given a more formal character: the interpretation of the unspoken pronoun can be formally identified by the agreement morphology.

Filling out the details of this theory is beyond the scope of this dissertation. But it is a theory that has precedent in the literature: the separation of the semantic ellipsis licensing condition from ellipsis itself, and rather locating it in independently available mechanisms of recoverability and accommodation, is the idea put forward in Tancredi 1992 and Fox 2000. I will end this chapter, however, with some potential problems for the idea that CP deletion is generally recoverable by reference to QUD-GIVENness.

### 5.13 Some remaining problems

If it is true that deleted CPs are recoverable by dint of being QUD-GIVEN, then we might imagine that this should also be true also for cases of Null Complement Anaphora (NCA; Hankamer & Sag 1976, Grimshaw 1979), such as those seen in (663).

(663) Who left?/Did John leave?

- a. I don't know.
- b. Go and find out.
- c. Guess.
- d. John didn't tell me.

(664) What John's doing is appalling.

- a. I agree.
- b. I know.
- c. I guessed.
- d. Yes, Mary told me.

These cases involve an embedding predicate with no overt complement (hence the name). There are syntactic restrictions on this; for example, only a subset of embedding predicates allow it, as Grimshaw 1979 shows:

(665) (from Grimshaw's (48))

Who left?

- a. Guess./\*Predict.
- b. John didn't tell me./\*John didn't divulge.
- c. Go and find out./\*Go and discover.

What John's doing is appalling.

- a. I guessed./\*I predicted.
- b. Yes, Mary told me./\*Mary divulged.
- c. Yes, Mary said./\*Yes, Mary reported.
- d. I agree./\*I think (too).

It's clear that null complement anaphora in this sense must not be quite the same as the CP ellipsis that has been discussed for fragment answers. Different verbs license it: *think* licenses fragment answers but not NCA; *agree* licenses NCA but not fragment answers (*Who left? — ??We agreed John*); *tell someone*, *say* and *guess* license both. So I do not want to claim that NCA is derived through the process of clausal ellipsis, in the sense discussed in this dissertation. Rather, we might assume that NCA involves the selection by a predicate of a CP pro-form, as Depiante 2000 proposes.

(666) a. Who left? – I don't know.

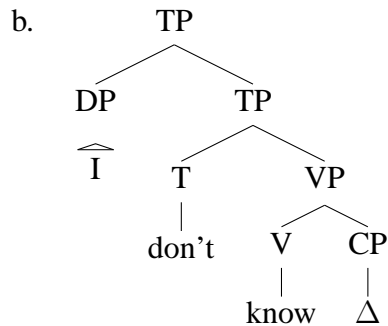

Whether this is ‘ellipsis’ or not, it appears to be failure to pronounce a CP. Unfortunately, it is not clear that the recoverability here is subject to QUD-GIVENness. For example, it was noted (following AnderBois 2010) that clausal ellipsis cannot pick up antecedents which are located in parentheticals, or can do this only with some difficulty, as shown by the below examples.

(667) a. \*John, who once killed someone in cold blood, can't even remember who.

b. \*John, who doesn't know who wrote this nasty letter, thinks Bill.

However, this does not hold of NCA. It appears that NCA can indeed pick up antecedents which are within parentheticals, at least with much greater ease than in the clausal ellipsis cases in (667).

(668) a. John, who was once told that the earth is flat, doesn't agree. (= doesn't agree that the earth is flat)

b. John, who doesn't know who wrote this nasty letter, is going to ask. (= is going to ask who wrote this nasty letter)

It's not clear, then, that the recoverability condition for CP null complement anaphora is QUD-GIVENness, which casts doubt on the hypothesis that the recoverability condition for silent CPs generally is QUD-GIVENness.

One recourse here might be to say that there is no silent CP pro-form in these examples. Grimshaw 1979 assumes a syntax in which NCA verbs literally have no complement at

all. This would be of a piece with the usual treatment of object ‘deletion’ generally, e.g. in examples like *John ate*; most treatments of such cases of optional transitivity do not assume that these verbs are syntactically combining with ‘empty’ arguments, but rather that they are (optionally) syntactically intransitive (see e.g. Dowty 1978, Kratzer 2003). Providing an argument for *agree, ask, know* etc. in NCA cases would take place entirely in the semantics; but there would be no issue about ‘recovering’ unspoken material in the syntax, as there would literally be no material to recover.

This has the unfortunate consequence of making it difficult to test whether my proposal, that QUD-GIVENNESS is the correct formulation of the recoverability condition for CPs, is correct. There is an additional mystery: if a verb like *believe* licenses clausal ellipsis in the fragment case, why is the below not possible?

(669) Did John leave? — \*I believe ~~that John left~~.<sup>203</sup>

That is, why does clausal ellipsis seem to *require* movement of a fragment or *wh*-phrase to the left edge of the elided clause? Why can clausal ellipsis not genuinely target entire clauses? Nothing in my system guarantees this. Putting a strong feature on the E-feature, as Merchant 2001, 2004 does, would accomplish this (requiring movement of an [F]-marked phrase to check the E-feature’s feature), but this move in a sense restates the problem; we want to know *why* the E-feature should have such a strong feature. In any case I do not want to claim that fragment movement is driven by feature checking, as argued in section 5.12.

One possible answer to this conundrum is that QUD-GIVENNESS in (669) is not in fact met. Imagine that a polar question  $?p$  denotes the set  $\{p, \neg p\}$ , as in Hamblin 1973. Then

---

<sup>203</sup>But these data are complicated. Jeremy Hartman (p.c.), for example, reports that he finds the answer *I think* grammatical here, and that does sound better to me than (669) does, especially if a strong contrastive topic/rise-fall-rise contour is placed on *think*. What seems strongly ungrammatical is varying the subject: *Did John leave? — \*Mary thinks*. That suggests that the grammatical reading of *I think* is derived in whatever way that the parenthetical cases described by Temmerman 2013b are (see also section 5.2.2). Note also that *Did John leave? — Mary thinks so*, with an overt pro-form for the clause, is fine. I will have to leave full investigation of these patterns to future work.

the union of this question is  $p \vee \neg p$  – a tautology. We might then predict problems with QUD-GIVENNESS, and indeed these obtain, as we can see by looking at (670).

- (670)
- a. QUD =  $\llbracket \text{Did John leave?} \rrbracket = \{\text{John left, John didn't leave}\}$
  - b.  $\bigcup \text{QUD} = \text{John left or John didn't leave}$
  - c.  $\llbracket \text{E} \rrbracket = \llbracket \text{that John left} \rrbracket = \text{that John left}$
  - d.  $\llbracket \text{E} \rrbracket^F = \{\text{that John left}\}$   
 (No focus alternatives here as nothing is in focus in the elided clause, so  $\llbracket \text{E} \rrbracket^F$  is just  $\{\llbracket \text{E} \rrbracket\}$ )
  - e.  $\bigcup \llbracket \text{E} \rrbracket^F = \text{that John left}$

Clearly, here, there is not mutual entailment between  $\bigcup \llbracket \text{E} \rrbracket^F$  and  $\bigcup \text{QUD}$ . ‘John left or John didn’t leave’ is a tautology, and entails nothing. So we might think that the failure of cases like (670) can be explained on these grounds. This explanation would, however, require us to believe that the denotation of a polar question is the set of both possible answers to it (i.e.  $?p = \{p, \neg p\}$ ). However, Biezma & Rawlins 2012 argue that the denotation of a polar question is the singleton set containing one proposition, i.e.  $?p = \{p\}$ . If that is right, then the problem in (670) would no longer be a problem: the QUD would be the set  $\{\text{John left}\}$ , the union of this would be the proposition ‘John left’, and mutual entailment would in fact hold. We would then predict elliptical cases such as (669) to be grammatical, contrary to fact. I will not try to settle this question here, however, but leave it for further work.

## 5.14 Conclusion

In this chapter, I have argued that fragments in English can embed, as would be expected from a clausal ellipsis analysis of fragments. However, the class of verbs which can embed fragments is a very restricted one: only bridge verbs can do this. I argue that this is due to the presence of a higher complementizer, C1 (or *c*, in de Cuba 2007’s terms; or Force, in cartographic terms (Rizzi 1997 and much subsequent work)). It is this head which,

in English (and, I assume, in other languages which pattern with English, like German and Dutch), licenses clausal ellipsis. I have supported this conclusion by arguing that sluicing is also subject to the same restriction: only in constructions in which C1 appears can sluicing occur. Cross-linguistically, some different constraints apply; and I have argued that constructions such as Hungarian relative clause ellipsis, or embedded fragments even under non-bridge verbs like *know*, *find out*, should be analyzed as being licensed by a different head, such as Focus.

## CHAPTER 6

### CONCLUSION

#### 6.1 Main results of the dissertation

In this dissertation, I have aimed to defend a view of fragments (such as (671)) in which they are created via a process of clausal ellipsis, as illustrated in (672).

(671) (repeated from (1))

- a. What did John eat? — Chips.
- b. Which students were dancing in the quad? — The Germans.
- c. A coffee, please.
- d. [Gesturing to an empty chair.]  
An editor of Natural Language Semantics.
- e. [Remonstrating with a child unsteadily holding a bowl of soup.]  
Both hands!

- (672)
- a. What did John eat? — Chips ~~he ate~~.
  - b. Which students were dancing in the quad? — The Germans ~~were dancing in the quad~~.
  - c. ~~I would like~~ a coffee, please.
  - d. ~~That chair is for~~ an editor of Natural Language Semantics.
  - e. ~~You should use~~ both hands!

This is the view defended by Merchant 2004. Various challenges to this view have been raised by, among others, Stainton (1998, 2005, 2006a, 2006b) and Jacobson 2013. I be-



lieve there is good evidence, however, to support a clausal ellipsis view of fragments; this evidence, mainly drawn from Merchant 2004, was reviewed in chapter 2.

I argue in chapter 3 that a revision of the semantic antecedence condition of clausal ellipsis to make reference to the Question under Discussion of Roberts 2012/1996, as proposed (in varying ways) by Ginzburg & Sag 2000, Reich 2007, AnderBois 2010, Collins et al. 2014, can however address these challenges, if augmented with a theory of domain restriction (von Stechow 1994, Martí 2003 a.m.o.). For example, in the below cases of fragment answers, the QUD-GIVENness condition requires that the union of the focus value of the elided clause mutually entail the union of the QUD. This requires that the domain of *Germans* in (673) be restricted to students, as shown in (674).

(673) A: Which students left early?

B: The Germans. (=The German students.)

(674) [<sub>CP1</sub> The Germans C1 [<sub>TP</sub> [<sub>DP</sub> ~~the Germans~~ C] left early ]]

$C = \lambda x.x$  is a student

I have also argued that a QUD-based condition on clausal ellipsis can help us understand cases of antecedentless fragments, as in (671c)–(671e). The fragment in these cases allows a Question under Discussion to be accommodated. The apparent requirement for the syntax of elided clauses to match the syntax of the antecedent – but only if an antecedent exists – is understood as following from a conditionalized version of Chung 2006’s ‘no new words’ condition: an ellipsis site must only contain lexical items which are contained within an antecedent if including other lexical items in the ellipsis site would be ‘gratuitous’; that is, if an ellipsis site communicating the correct meaning can be built up only of words which are contained within an antecedent, then the ellipsis site *must* be made up only of those words.

The kind of movement implied in (671), and defended by Merchant 2004, is not one which is licit in non-elliptical environments in English. It also seems as if it is not in-

terpreted, for example for the purposes of NPI licensing and *each...the other* binding. I argue in chapter 4 that this can be captured by analyzing this sort of movement as a PF-only movement, driven by the need of PF to move a stressed constituent outside of the domain of ellipsis.

Such a movement should in principle be able to take place in embedded environments as well as matrix ones. I have argued in chapter 5 that this does indeed take place. However, at least in English (and other languages such as Spanish and Dutch), this embedding is only possible under a subset of verbs, the so-called bridge verbs. I have argued that this follows from the proposal that bridge verbs embed double-complementizer structures, and that the higher complementizer head C1 is the head which is responsible for licensing clausal ellipsis. Only structures which contain C1 license clausal ellipsis. I have defended this view by investigating where sluicing is licensed, and concluding that indeed only structures which can independently be argued to contain C1 are structures which undergo clausal ellipsis.

## 6.2 Directions for further work

One avenue for future work will be to extend QUD-GIVENNESS to other constructions which look like they might contain clausal ellipsis. As noted by Reich 2007 and Toosarvandani 2013, the phenomenon of gapping also looks like it makes reference to the Question under Discussion. Consider an example like (675).

(675) John ate oysters and Mary swordfish.

Such an example is most felicitously pronounced with contrastive topic intonation on *Mary* and focus intonation on *shellfish*. Such intonation contours suggest that the Question under Discussion in (675) is *Who ate what?* This raises the question of whether gapping is subject to QUD-GIVENNESS. And indeed ‘gapped’ answers are possible answers to questions like *who ate what?*

(676) Who ate what?

John the oysters, Mary the swordfish, Bill the beans, . . .

Further evidence that gapping and fragments may be assimilated to each other, as suggested by Reich 2007, is provided by similarities in the environments in which they are licensed. As pointed out by Johnson 2009, gapping cannot find antecedents in embedded clauses, as shown in (677). It also appears that gapping cannot itself appear in embedded clauses, as (678) shows.

(677) a. \*Bill thinks that John ate oysters, and Mary swordfish.

(\* on reading where *Mary swordfish* is not embedded under *thinks*; that is ‘Bill thinks that John ate oysters, and (I am telling you for a fact) Mary ate swordfish’)

b. \*Before/because John ate oysters, Mary swordfish.

(678) a. \*John ate oysters and I think that Mary swordfish.

b. \*John ate oysters before/because Mary swordfish.

However, note that if the complementizer is removed from (678a), it improves significantly.<sup>204</sup>

(679) ?John ate oysters and I think Mary swordfish.

Moreover, the verbs which allow embedded gapping of the sort in (679) seem to pattern with the verbs which allow embedded fragment answers. Not all of the bridge verbs in

---

<sup>204</sup>(679) is somewhat marked, but it represents a considerable improvement on (678a), I think. Johnson to appear reports the below similar case as ungrammatical (his (27)):

(i) (\*)Mary left early, and I think Sally too.

To my ear, (i) is well-formed. It is possible that I am giving *I think* a parse as a parenthetical, but even if the subject is changed, I find the structure fairly acceptable:

(ii) ?Mary left early, and Bill thinks Sally too.

(680a) are perfect by any means, but I believe there is a clear contrast between these cases and the cases in (680b, c).

- (680) John ate oysters. . .
- a. and I { ?think/?believe/??hope/suspect/?was told/imagine } Mary swordfish.
  - b. and I { ?\*found out/\*remember/\*deny/?\*know } Mary swordfish.
  - c. and I { \*am proud/\*am angry/\*am surprised } Mary swordfish.

Moreover, I believe that a case of gapping cannot find its antecedent within a parenthetical. The examples to show this clearly are rather difficult to construct, but consider the example in (681).

- (681) John, who has a seafood allergy, can't eat this; ?\*and Mary, a shellfish allergy, so she can't eat this either.
- (intended: *and Mary has a shellfish allergy*)

This is reminiscent of AnderBois 2010's observation that sluices cannot find their antecedents in parentheticals, which was captured here by way of the QUD-GIVENNESS condition. It may therefore be fruitful to attempt to find a parallel, such as the one discussed by Reich 2007, between the condition on gapping and that on clausal ellipsis in fragments. Of course, this would have its own problems. Johnson 2009 points out a number of facts which strongly suggest that whatever gapping is, it is not a conjunction of entire clauses (suggesting that, if ellipsis is involved in gapping, it is not clausal ellipsis). For example, as noted by Oehrle 1987 and McCawley 1993, the subject can take scope over the whole gapped conjunction (binding something in the second conjunct, for example, as shown in (682a)), suggesting that 'small' constituents are being conjoined in gapping, rather than 'large' constituents like clauses.

(682) (Johnson 2009's (14))

- a. No woman<sub>i</sub> can enter the army and her<sub>i</sub> girlfriend the navy.
- b. \*No woman<sub>i</sub> can enter the army and/but her<sub>i</sub> girlfriend can enter the navy.

And Johnson's own account of gapping (in which a verb undergoes across-the-board movement to a position above two conjoined verb phrases) would already let us understand the failure of the cases in (681) (although it's less obvious that it captures the relative goodness of cases like (679), or the contrasts shown in (680)). So an attempt to fully reconcile the fact surrounding gapping with the facts surrounding fragment ellipsis would face a number of challenges. That's why I leave it to future work here.

Perhaps a less daunting task would be to attempt to unify fragments with cases of non-constituent coordination, such as those in (683) (examples taken from Sailor & Thoms 2014).

- (683)
- a. John spoke to Mary on Tuesday and Bill on Wednesday.
  - b. I told stories about my family for a few minutes and my pets for a few hours.
  - c. He told them that he knew Spanish on Thursday and Italian on Friday.
  - d. I claimed that I was a spy to impress John and an astronaut to impress Bill.

Sailor & Thoms 2014 have argued that these represent movement of two constituents to the left periphery of the second conjunct, followed by clausal ellipsis.

(684) John spoke to Mary on Tuesday and [<sub>CP</sub> Bill<sub>1</sub> [<sub>CP</sub> [on Wednesday]<sub>2</sub> [<sub>TP</sub> ~~he spoke to t<sub>1</sub> t<sub>2</sub>]]]]~~

Again, note that the first element in such cases has to bear contrastive topic accent, and the second, focus accent.

(685) John spoke to Mary on Tuesday and [<sub>CT</sub> Bill] [<sub>F</sub> on Wednesday].

This is again suggestive that such cases are standing in a particular relation with a Question under Discussion such as *Who did John speak to when?* In addition, we see a similar pattern of embedding as we do in fragments: non-constituent coordinations can be embedded, but only under bridge verbs.

- (686) John spoke to Mary on Tuesday. . .
- a. and I {think/believe/hope/suspect/?was told/imagine} Bill on Wednesday.
  - b. and I {??found out/\*remember/\*deny/?\*know} Bill on Wednesday.
  - c. and I {\*am proud/\*am angry/\*am surprised} Bill on Wednesday.

That's a welcome result given the arguments in chapter 5 of this dissertation; it supports Sailor & Thoms 2014's proposal that these cases involve clausal ellipsis. Fully elaborating these proposals would require further work, but we can see here at least preliminary support for the idea.

A wider possible topic for future work may be to address whether the QUD-GIVENNESS condition is proprietary to (clausal) ellipsis – and if it is, whether it should be encoded in the lexical entry of the [E]-feature, as Merchant 2001, 2004 argues – or whether it is part of a larger 'toolbox' governing the recoverability of unspoken material, as discussed towards the end of chapter 5. We also wish to understand where QUD-GIVENNESS is to be situated in a general theory of grammar. I have developed QUD-GIVENNESS with reference to semantic facts of English, and have not attempted semantic cross-linguistic comparison. Is QUD-GIVENNESS a linguistic universal on fragments and fragment answers? Or is it a language-specific property, such that (for example) English may use QUD-GIVENNESS as its antecedence condition on clausal ellipsis, but other languages may use other conditions? If QUD-GIVENNESS is a universal, should this be formulated as a constraint which is present in Universal Grammar, or does it follow from other, more general properties of communication and social interaction, in the way that pragmatic principles (and indeed the Question under Discussion itself) are generally thought to do?

### 6.3 The end<sup>205</sup>

These are all questions which remain. However, hopefully this dissertation has succeeded in giving answers to at least a few questions. The answers have been rather long, but I end the dissertation with their short variants.

- (687)
- a. What creates fragment answers? — Ellipsis.
  - b. What's the semantic condition on clausal ellipsis? — QUD-GIVENNESS.
  - c. When do fragments move? — At PF.
  - d. What licenses clausal ellipsis? — A high complementizer.

---

<sup>205</sup>Or 'the end<sub>1</sub> this is t<sub>1</sub>'?

## BIBLIOGRAPHY

- Abels, Klaus. 2003. *Successive Cyclicity, Anti-locality, and Adposition Stranding*. University of Connecticut dissertation.
- Abels, Klaus. 2012. The Italian left periphery: A view from locality. *Linguistic Inquiry* 43(2). 229–54.
- Abrusán, Márta & Benjamin Spector. 2011. A semantics for degree questions based on intervals: negative islands and their obviation. *Journal of Semantics* 28(1). 107–47.
- Aelbrecht, Lobke. 2009. *You have the right to remain silent: the syntactic licensing of ellipsis*. Katholieke Universiteit Brussel dissertation.
- Aelbrecht, Lobke. 2010. *The syntactic licensing of ellipsis*. Amsterdam/New York: John Benjamins.
- Almeida, Diogo A. de A. & Masaya Yoshida. 2007. A problem for the preposition stranding generalization. *Linguistic Inquiry* 38(2). 349–62.
- Alonso-Ovalle, Luis. 2006. *Disjunction in alternative semantics*. University of Massachusetts Amherst dissertation.
- AnderBois, Scott. 2010. Sluicing as anaphora to issues. In Nan Li & David Lutz (eds.), *Proceedings of SALT 20*, 428–50. Ithaca, NY: CLC Publications, Cornell University.
- Aoun, Joseph & Elabbas Benmamoun. 1998. Minimality, reconstruction, and PF movement. *Linguistic Inquiry* 29(4). 569–97.
- Authier, J.-Marc. 1992. Iterated CPs and embedded topicalization. *Linguistic Inquiry* 23(2). 329–36.
- Barbiers, Sjef. 2000. The right-periphery in SOV-languages: English and Dutch. In Peter Svenonius (ed.), *The derivation of VO and OV*, 181–218. Amsterdam/Philadelphia: John Benjamins.
- Barker, Chris & Pauline Jacobson (eds.). 2007. *Direct compositionality*. Oxford: Oxford University Press.
- Barros, Matthew. 2012. (Pseudo-)sluicing and *else*-modified correlates. Poster presented at NELS 43, City University of New York, October 19.
- Barros, Matthew. to appear. A non-repair approach to island sensitivity in contrastive TP ellipsis. In *Proceedings of CLS 48*, Chicago: Chicago Linguistic Society.



- Barros, Matthew, Patrick D. Elliott & Gary Thoms. to appear. More variation in island repair: Clausal vs. non-clausal islands. In *Proceedings of CLS 49*, Chicago: Chicago Linguistic Society.
- Barss, Andrew. 1986. *Chains and anaphoric dependence*. Massachusetts Institute of Technology dissertation.
- Beaver, David I., Brady Clark, Edward Stanton Flemming, T. Florian Jaeger & Maria Wolters. 2007. When semantics meets phonetics: Acoustical studies of second-occurrence focus. *Language* 83(2). 245–76.
- Bech, Gunnar. 1955/1957. *Studien über das deutsche Verbum infinitivum*. Copenhagen: Ejnar Munksgaard.
- Beck, Sigrid. 2006. Intervention effects follow from focus interpretation. *Natural Language Semantics* 14(1). 1–56.
- den Besten, Hans. 1981/1977. On the interaction of root transformations and lexical deletive rules. *Groninger Arbeiten zur Germanistischen Linguistik* 20.
- Bhatt, Rajesh & Veneeta Dayal. 2014. Polar *kyaa*: Y/N or speech act operator. Handout from presentation at the Workshop on Non-Canonical Questions and Interface Issues, Universität Konstanz, February 18.
- Biezma, Maria & Kyle Rawlins. 2012. Responding to alternative and polar questions. *Linguistics and Philosophy* 35(5). 361–406.
- Blok, Peter I. & Kurt Eberle. 1999. What is the alternative? The computation of focus alternatives from lexical and sortal information. In Peter Bosch & Rob van der Sandt (eds.), *Focus: Linguistic, cognitive and computational perspectives*, 105–120. Cambridge, England: Cambridge University Press.
- Boone, Enrico. 2013. Exceptional movement is unexceptionally local. Presentation at NELS 44, University of Connecticut, October 18–20.
- Bošković, Željko. 2005. Left branch extraction, structure of NP, and scrambling. In Joachin Sabel & Mamoru Saito (eds.), *The free word order phenomenon: its syntactic sources and diversity*, 13–73. Berlin: Mouton de Gruyter.
- Brody, Michael. 1990. Some remarks on the focus field in Hungarian. *UCL Working Papers in Linguistics* 2. 201–25.
- Büring, Daniel. 2003. On D-trees, beans, and B-accents. *Linguistics and Philosophy* 26(5). 511–45.
- Cable, Seth. 2012. Pied-piping: introducing two recent approaches. *Language and Linguistics Compass* 6(12). 816–32.
- Chao, Wynn. 1987. *On ellipsis*. University of Massachusetts Amherst dissertation.

- Chierchia, Gennaro. 1992. Functional WH and weak crossover. In Dawn Bates (ed.), *Proceedings of WCCFL 10*, 75–90. Stanford: CSLI Publications.
- Chomsky, Noam. 1981. *Lectures on Government and Binding*. Dordrecht: Foris.
- Chomsky, Noam. 1986. *Barriers*. Cambridge, MA: MIT Press.
- Chomsky, Noam. 1995. *The minimalist program*. Cambridge, MA: MIT Press.
- Chomsky, Noam. 2008. On phases. In Robert Freidin, Carlos P. Otero & Maria Luisa Zubizarreta (eds.), *Foundational issues in linguistic theory: Essays in honor of Jean-Roger Vergnaud*, Cambridge, MA: MIT Press.
- Chung, Sandra. 2006. Sluicing and the lexicon: the point of no return. In R. T. Cover & Y. Kim (eds.), *Proceedings of BLS 31*, 73–91. Berkeley, CA: Berkeley Linguistics Society.
- Chung, Sandra. 2013. Syntactic identity in sluicing: How much and why. *Linguistic Inquiry* 44(1). 1–44.
- Chung, Sandra, William Ladusaw & James McCloskey. 1995. Sluicing and logical form. *Natural Language Semantics* 3(3). 239–82.
- Chung, Sandra, William Ladusaw & James McCloskey. 2011. Sluicing(:) between structure and inference. In Rodrigo Gutiérrez, Line Mikkelsen & Eric Potsdam (eds.), *Representing language: essays in honor of Judith Aissen*, 31–50. Linguistic Research Center, UC Santa Cruz.
- Cinque, Guglielmo. 1995. *Italian syntax and Universal Grammar* (Cambridge Studies in Linguistics 77). Cambridge, England: Cambridge University Press.
- Clements, George N. 1975. The logophoric pronoun in Ewe: its role in discourse. *Journal of West African Languages* 10(2). 141–77.
- Cohen, Ariel. 1999. How are alternatives computed? *Journal of Semantics* 16. 43–65.
- Collins, Chris & Phil Branigan. 1997. Quotative inversion. *Natural Language and Linguistic Theory* 15(1). 1–41.
- Collins, Chris & Paul M. Postal. 2012. *Imposters: a study of pronominal agreement*. Cambridge, MA: MIT Press.
- Collins, James N., Daria Popova, Ivan A. Sag & Thomas Wasow. 2014. Sluicing and the inquisitive potential of appositives. Ms. Stanford University. [http://www.stanford.edu/~jamesnc/ssg-sluicing\\_appositives-collins.pdf](http://www.stanford.edu/~jamesnc/ssg-sluicing_appositives-collins.pdf).
- Constant, Noah. 2012a. Topic abstraction as the source for nested alternatives: a conservative semantics for contrastive topic. In Nathan Arnett & Ryan Bennett (eds.), *Proceedings of WCCFL 30*, 120–30. Somerville, MA: Cascadilla Press.

- Constant, Noah. 2012b. Witnessable quantifiers license type-e meaning: Evidence from contrastive topic, equatives and supplements. In Anca Chereches (ed.), *Proceedings of SALT 22*, 286–306. Ithaca, NY: CLC Publications, Cornell University.
- Coppock, Elizabeth. 2001. Gapping: in defense of deletion. In Mary Andronis, Christopher Ball, Heidi Elston & Sylvain Neuvel (eds.), *Proceedings of CLS 37*, 133–48. Chicago: Chicago Linguistic Society.
- van Craenenbroeck, Jeroen. 2004. *Ellipsis in Dutch dialects*. Universiteit Leiden dissertation.
- van Craenenbroeck, Jeroen. 2010a. Invisible Last Resort: A note on clefts as the underlying source for sluicing. *Lingua* 120. 1714–26.
- van Craenenbroeck, Jeroen. 2010b. *The syntax of ellipsis: evidence from Dutch dialects*. Oxford: Oxford University Press.
- van Craenenbroeck, Jeroen. 2013a. Ellipsis, identity, and accommodation. Ms. Katholieke Universiteit Leuven/Hogeschool-Universiteit Brussel. <http://jeroenvancraenenbroeck.net/s/paper-ellipsis-and-accommodation.pdf>.
- van Craenenbroeck, Jeroen. 2013b. Ellipsis, identity, and accommodation: The case of case. Talk presented at the Identity in Ellipsis workshop, Universiteit Leiden, September 20–21.
- van Craenenbroeck, Jeroen & Anikó Lipták. 2006. The cross-linguistic syntax of sluicing: evidence from Hungarian relatives. *Syntax* 9(3). 248–74.
- van Craenenbroeck, Jeroen & Tanja Temmerman. 2010. How (not) to elide negation. Presentation at NELS 41, University of Pennsylvania, October 22–24.
- de Cuba, Carlos. 2007. *On (non)factivity, clausal complementation and the CP-field*. State University of New York at Stony Brook dissertation.
- de Cuba, Carlos & Jonathan E. MacDonald. 2013. On the referential status of embedded polarity answers in Spanish. In Jennifer Cabrelli Amaro, Gillian Lord, Ana de Prada Pérez & Jessi Elana Aaron (eds.), *Selected proceedings of the 16th Hispanic Linguistics Symposium*, 312–23. Somerville, MA: Cascadilla Press.
- de Cuba, Carlos & Barbara Ürögdi. 2010. Clearing up the ‘facts’ on complementation. *University of Pennsylvania Working Papers in Linguistics* 16(1).
- Culicover, Peter W. 1970. One more can of beer. *Linguistic Inquiry* 1. 366–9.
- Culicover, Peter W. 1972. OM-sentences. *Foundations of Language* 8. 199–236.
- Culicover, Peter W. & Ray Jackendoff. 1997. Semantic subordination despite syntactic coordination. *Linguistic Inquiry* 28(2). 195–217.

- Culy, Christopher. 1994a. Aspects of logophoric marking. *Linguistics* 32(6). 1055–94.
- Culy, Christopher. 1994b. A note on logophoricity in Dogon. *Journal of African Languages and Linguistics* 15(2). 113–25.
- Culy, Christopher. 1997. Logophoric pronouns and point of view. *Linguistics* 35. 845–59.
- Dayal, Veneeta. 1996. *Locality in WH quantification*. Dordrecht: Kluwer.
- Dayal, Veneeta. 1997. Free relatives and *ever*: Identity and free choice readings. In A. Lawson (ed.), *Proceedings of SALT 7*, 99–116. Ithaca, NY: CLC Publications, Cornell University.
- De Clercq, Karen. 2011. *Squat, zero and no/nothing*: syntactic negation vs. semantic negation. In Rick Nouwen & Marion Elenbaas (eds.), *Linguistics in the Netherlands 2011*, 14–24. Amsterdam: John Benjamins.
- Depiante, Marcela Andrea. 2000. *The syntax of deep and surface anaphora: a study of null complement anaphora and stripping/bare argument ellipsis*. University of Connecticut dissertation.
- den Dikken, Marcel, André Meinunger & Chris Wilder. 2000. Pseudoclefts and ellipsis. *Studia Linguistica* 54(1). 41–89.
- Dowty, David. 1978. Governed transformations as lexical rules in a Montague Grammar. *Linguistic Inquiry* 9(3). 393–426.
- Dubinsky, Stanley & Robert Hamilton. 1998. Epithets as antilogophoric pronouns. *Linguistic Inquiry* 29(4). 685–93.
- Elbourne, Paul D. 2005. *Situations and individuals*. Cambridge, MA: MIT Press.
- Elliott, Dale. 1971. *The grammar of emotive and exclamatory sentences in English*. Ohio State University dissertation.
- Elliott, Patrick D. 2013. Towards a dual account of ellipsis identity. Talk presented at the Manchester Forum in Linguistics, University of Manchester.
- Engdahl, Elisabet. 1986. *Constituent questions*. Dordrecht: Reidel.
- Erteschik-Shir, Nomi. 1973. *On the nature of island constraints*. Massachusetts Institute of Technology dissertation.
- Erteschik-Shir, Nomi. 1977. *On the nature of island constraints*. Bloomington, IN: Indiana University Linguistics Club.
- Farkas, Donka F. & Kim B. Bruce. 2010. On reacting to assertions and polar questions. *Journal of Semantics* 27(1). 81–118.
- Fiengo, Robert & Howard Lasnik. 1972. On nonrecoverable deletion in syntax. *Linguistic Inquiry* 3(4). 528.

- von Fintel, Kai. 1994. *Restrictions on quantifier domains*. University of Massachusetts Amherst dissertation.
- von Fintel, Kai. 2012. Imperative puzzles. Colloquium talk given at UMass Amherst. <http://web.mit.edu/fintel/fintel-2012-umass-imperatives.pdf>.
- Fox, Danny. 1999. Reconstruction, binding theory, and the interpretation of chains. *Linguistic Inquiry* 30(2). 157–96.
- Fox, Danny. 2000. *Economy and semantic interpretation*. Cambridge, MA: MIT Press.
- Fox, Danny. 2002. Antecedent-contained deletion and the copy theory of movement. *Linguistic Inquiry* 33(1). 63–96.
- Fox, Danny & Martin Hackl. 2006. The universal density of measurement. *Linguistics and Philosophy* 29(5). 537–86.
- Fox, Danny & Roni Katzir. 2011. On the characterization of alternatives. *Natural Language Semantics* 19(1). 87–107.
- Fox, Danny & David Pesetsky. 2005. Cyclic linearization of syntactic structure. *Theoretical Linguistics* 31(1). 1–45.
- Gawron, Jean Mark. 2001. Universal concessive conditionals and alternative NPs in English. In Cleo Condoravdi & Gerard Renardel de Lavalette (eds.), *Logical perspectives on language and information*, 73–106. Stanford: CSLI Publications.
- Geurts, Bart. 2007. Existential import. In Ileana Comorovski & Klaus von Heusinger (eds.), *Existence: syntax and semantics*, 253–71. Dordrecht: Springer.
- Giannakidou, Anastasia. 2002. Licensing and sensitivity in polarity items: from downward entailment to nonveridicality. In M. Andronis, A. Pycha & K. Yoshimura (eds.), *Proceedings of CLS 38*, 29–53. Chicago: Chicago University Press.
- Giannakidou, Anastasia. 2011. Positive polarity items and negative polarity items: variation, licensing, and compositionality. In Claudia Maienborn, Klaus von Heusinger & Paul Portner (eds.), *Semantics: an international handbook of natural language meaning*, Berlin: Mouton de Gruyter.
- Ginzburg, Jonathan. 1992. *Questions, queries and facts: A semantics and pragmatics for interrogatives*. Stanford University dissertation.
- Ginzburg, Jonathan & Ivan Sag. 2000. *Interrogative investigations*. Stanford: CSLI Publications.
- Gordon, P. C., B. J. Grosz & L. A. Gilliom. 1993. Pronouns, names, and the centering of attention in discourse. *Cognitive Science* 17. 311–47.

- Green, Georgia. 1976. Main clause phenomena in subordinate clauses. *Language* 52(2). 382–97.
- Griffiths, James & Anikó Lipták. 2014. Contrast and island sensitivity in clausal ellipsis. Forthcoming in *Syntax*.
- Grimshaw, Jane. 1979. Complement selection and the lexicon. *Linguistic Inquiry* 10(2). 279–326.
- Groenendijk, Jeroen & Martin Stokhof. 1984. *Studies on the semantics of questions and the pragmatics of answers*. University of Amsterdam dissertation.
- Groenendijk, Jeroen & Martin Stokhof. 1989. Type-shifting rules and the semantics of interrogatives. In Gennaro Chierchia, Barbara H. Partee & Raymond Turner (eds.), *Properties, types and meanings. vol. 2: Semantic issues*, Dordrecht: Kluwer.
- Grosz, Patrick Georg. 2012. *On the grammar of optative constructions* (Linguistik Aktuell/Linguistics Today 193). Amsterdam: John Benjamins.
- de Haan, Germen & Fred Weerman. 1986. Finiteness and verb fronting in Frisian. In Hubert Haider & Martin Prinzhorn (eds.), *Verb second phenomena in Germanic languages*, 77–110. Dordrecht: Foris.
- Haegeman, Liliane. 1997. Register variation, truncation, and subject omission in English and in French. *English Language and Linguistics* 1(2). 233–70.
- Haegeman, Liliane. 2006a. Argument fronting in English, Romance CLLD and the left periphery. In Raffaella Zanuttini, Héctor Campos, Elena Herburger & Paul Portner (eds.), *Crosslinguistic research in syntax and semantics: Negation, tense, and clausal architecture*, 27–52. Washington, DC: Georgetown University Press.
- Haegeman, Liliane. 2006b. Conditionals, factives and the left periphery. *Lingua* 116. 1651–69.
- Haegeman, Liliane. 2007. Subject omission in present-day written English: On the theoretical relevance of peripheral data. *Rivista di grammatica generativa* 32. 91–124.
- Haegeman, Liliane. 2012. *Adverbial clauses, main clause phenomena, and the composition of the left periphery*. Oxford: Oxford University Press.
- Haegeman, Liliane & Tabea Ihsane. 2001. Adult null subjects in the non-*pro*-drop languages: two diary dialects. *Language Acquisition* 9(4). 329–346.
- Haegeman, Liliane & Barbara Ürögdi. 2010. Referential CPs: an operator movement account. *Theoretical Linguistics* 36(2). 111–52.
- Hagège, Claude. 1974. Les pronoms logophoriques. *Bulletin de la Société de Linguistique de Paris* 69. 287–310.

- Hamblin, Charles. 1973. Questions in Montague English. *Foundations of Language* 10(1). 41–53.
- Hankamer, Jorge & Ivan Sag. 1976. Deep and surface anaphora. *Linguistic Inquiry* 7(3). 391–426.
- Hardt, Daniel. 1993. *Verb phrase ellipsis: Form, meaning, and processing*. University of Pennsylvania dissertation.
- Hartman, Jeremy. 2011. The semantic uniformity of traces: evidence from ellipsis parallelism. *Linguistic Inquiry* 42(3). 367–88.
- Hartman, Jeremy & Ruixi Ressay Ai. 2007. A focus account of swiping. Ms., Harvard University.
- Hausser, Roland. 1983. On questions. In Ferenc Kiefer (ed.), *Questions and answers*, 97–158. Dordrecht: Reidel.
- Heck, Fabian. 2009. On certain properties of pied-piping. *Linguistic Inquiry* 40(1). 75–111.
- Heim, Irene. 1982. *The semantics of definite and indefinite Noun Phrases*. University of Massachusetts Amherst dissertation.
- Heim, Irene. 1994. Interrogative semantics and Karttunen's semantics for *know*. In Rhonna Buchalla & Anita Mittwoch (eds.), *Proceedings of IATL 1*, Jerusalem: Hebrew University of Jerusalem.
- Heim, Irene. 2012. Functional readings without type-shifted noun phrases. Ms. Massachusetts Institute of Technology. <http://semanticsarchive.net/Archive/TUwYzUwZ/functional%20readings.pdf>.
- Heim, Irene & Angelika Kratzer. 1998. *Semantics in generative grammar*. Malden: Blackwell.
- Hooper, J. B. & Sandra A. Thompson. 1973. On the applicability of root transformations. *Linguistic Inquiry* 4(4). 465–97.
- Huang, C.-T. James. 1993. Reconstruction and the structure of VP: some theoretical consequences. *Linguistic Inquiry* 24(1). 103–38.
- Huddleston, Rodney & Geoffrey K. Pullum. 2002. *The Cambridge grammar of the English language*. Cambridge, England: Cambridge University Press.
- Iatridou, Sabine & Anthony Kroch. 1992. The licensing of CP-recursion and its relevance to the Germanic verb-second phenomenon. *Working Papers in Scandinavian Syntax* 50.
- Izvorski, Roumyana. 2000. *Free relatives and related matters*. University of Pennsylvania dissertation.

- Jackendoff, Ray. 1972. *Semantic interpretation in generative grammar*. Cambridge, MA: MIT Press.
- Jacobs, Joachim. 1980. Lexical decomposition in Montague Grammar. *Theoretical Linguistics* 7(1–3). 121–36.
- Jacobson, Pauline. 1994. Binding connectivity in copular sentences. In M. Harvey & L. Santelmann (eds.), *Proceedings of SALT 4*, 161–78.
- Jacobson, Pauline. 2013. The short answer: implications for Direct Compositionality (and vice versa). Ms. Brown University.
- Jayaseelan, K. S. 1990. Incomplete VP deletion and gapping. *Linguistic Analysis* 20. 64–81.
- Jespersen, Otto. 1909–1949. *A modern English grammar on historical principles*. London: George Allen & Unwin Ltd.
- Johnson, Kyle. 2001. What VP ellipsis can do, and what it can't, but not why. In Mark Baltin & Chris Collins (eds.), *The handbook of contemporary syntactic theory*, 439–79. Oxford: Blackwell.
- Johnson, Kyle. 2009. Gapping is not (VP) ellipsis. *Linguistic Inquiry* 40(2). 289–328.
- Johnson, Kyle. 2013a. The Empty Category Principle and linearization. Talk presented at the Comparative Germanic Syntax Workshop, Universität Leipzig, October 5. [http://people.umass.edu/kbj/homepage/Content/Leipzig\\_hand.pdf](http://people.umass.edu/kbj/homepage/Content/Leipzig_hand.pdf).
- Johnson, Kyle. 2013b. Licensing ellipsis. *Studies in Chinese Linguistics* 34(2). 71–98.
- Johnson, Kyle. to appear. Gapping. In Martin Everaert, Henk C. van Riemsdijk, Rob Goedemans & Bart Hollebrandse (eds.), *The Blackwell companion to syntax*, Oxford: Blackwell.
- Katzir, Roni. 2007. Structurally-defined alternatives. *Linguistics and Philosophy* 30(6). 669–90.
- Kaufmann, Magdalena. 2012. *Interpreting imperatives*. Dordrecht: Springer.
- Kennedy, Christopher. 1997. Antecedent-contained deletion and the syntax of quantification. *Linguistic Inquiry* 28(4). 662–88.
- Kennedy, Christopher & Jason Merchant. 2000. Attributive comparative deletion. *Natural Language and Linguistic Theory* 18. 89–146.
- Kim, Jeong-Seok. 1997. Sluicing in English. *Studies in Generative Grammar* 7.
- Kiparsky, Paul & Carol Kiparsky. 1971. Fact. In D. D. Steinberg & L. A. Jakobovits (eds.), *Semantics: an interdisciplinary reader in philosophy, linguistics and psychology*, 345–69. Cambridge, England: Cambridge University Press.



- Koopman, Hilda & Dominique Sportiche. 1989. Pronouns, logical variables, and logophoricity in Abe. *Linguistic Inquiry* 20(4). 555–88.
- Koopman, Hilda & Dominique Sportiche. 1991. The position of subjects. *Lingua* 85(2/3).
- Kratzer, Angelika. 1977. What ‘must’ and ‘can’ must and can mean. *Linguistics and Philosophy* 1(3). 337–55.
- Kratzer, Angelika. 1979. Conditional necessity and possibility. In Rainer Bäuerle, Urs Egli & Arnim von Stechow (eds.), *Semantics from different points of view*, Berlin: Springer-Verlag.
- Kratzer, Angelika. 1981. The notional category of modality. In H.-J. Eikmeyer & H. Rieser (eds.), *Words, worlds and contexts, new approaches to word semantics*, Berlin: Walter de Gruyter.
- Kratzer, Angelika. 1995. Stage-level and individual-level predicates. In Gregory N. Carlson & Francis J. Pelletier (eds.), *The generic book*, 125–75. Chicago: University of Chicago Press.
- Kratzer, Angelika. 1996. Severing the external argument from its verb. In J. Rooryck & L. Zaring (eds.), *Phrase structure and the lexicon*, Dordrecht: Kluwer.
- Kratzer, Angelika. 2003. The event argument. Ms. University of Massachusetts Amherst. <http://semanticsarchive.net/Archive/GU1NWM4Z/>.
- Kratzer, Angelika. 2004. Covert quantifier restrictions in natural languages. Presentation at the Milan Meeting on Covert Variables at Logical Form, Palazzo Feltrinelli, Gargnano. <http://semanticsarchive.net/Archive/mIzMGUYZ/Covert%20Quantifier%20Domain%20Restrictions.pdf>.
- Kratzer, Angelika. 2005. Building resultatives. In C. Maeinborn & A. Wöllstein-Leisten (eds.), *Event arguments in syntax, semantics and discourse*, 177–212. Tübingen: Niemeyer.
- Kratzer, Angelika. 2006. Decomposing attitude verbs. Talk presented at the Hebrew University of Jerusalem, July 4. <http://semanticsarchive.net/Archive/DcwY2JkM/attitude-verbs2006.pdf>.
- Kratzer, Angelika. 2013. Modality and the semantics of embedding. Talk presented at the Amsterdam Colloquium, December 20. <http://blogs.umass.edu/kratzer/files/2014/01/Kratzer-Semantics-of-Embedding.pdf>.
- Kratzer, Angelika & Junko Shimoyama. 2002. Indeterminate pronouns: the view from Japanese. In Yukio Otsu (ed.), *Proceedings of the 3rd Tokyo conference on psycholinguistics*, 1–25. Tokyo: Hituzi Syobo.
- Krifka, Manfred. 2001. Quantifying into question acts. *Natural Language Semantics* 9. 1–40.

- Krifka, Manfred. 2002. Embedded speech acts. Handout from the workshop *In the Mood*, Universität Frankfurt am Main. <http://amor.cms.hu-berlin.de/~h2816i3x/Talks/EmbeddedSpeechActs.pdf>.
- Krifka, Manfred. 2004. Focus and/or context: a second look at second occurrence expressions. In Hans Kamp & Barbara H. Partee (eds.), *Context-dependence in the analysis of linguistic meaning*, 187–207. Amsterdam: Elsevier.
- Krifka, Manfred. 2006. Association with focus phrases. In Valeria Molnar & Susanne Winkler (eds.), *The architecture of focus*, 105–36. Berlin: Mouton de Gruyter.
- Krifka, Manfred. 2012. Embedding speech acts. Forthcoming in Tom Roeper & Peggy Speas (eds.), *Recursion in language and cognition*.
- Ladusaw, William A. 1979. *Polarity sensitivity as inherent scope relations*. University of Texas, Austin dissertation.
- Lasnik, Howard. 1976. Remarks on coreference. *Linguistic Analysis* 2. 1–22.
- Lasnik, Howard. 1999. Pseudogapping puzzles. In E. Elabbas & S. Lappin (eds.), *Fragments: Studies in ellipsis and gapping*, 141–74. Oxford: Oxford University Press.
- Lewis, David. 1975. Adverbs of quantification. In E. L. Keenan (ed.), *Formal semantics of natural language*, 3–15. Cambridge, England: Cambridge University Press.
- Lobeck, Anne. 1995. *Ellipsis: functional heads, licensing and identification*. New York: Oxford University Press.
- Martí, Luisa. 2003. *Contextual variables*. University of Connecticut dissertation.
- McCawley, James D. 1993. Gapping with shared operators. In David A. Peterson (ed.), *Proceedings of BLS 19*, Berkeley, CA: Berkeley Linguistics Society.
- McCloskey, James. 2006. Questions and questioning in a local English. In Raffaella Zanuttini, Héctor Campos, Elena Herburger & Paul H. Portner (eds.), *Crosslinguistic research in syntax and semantics: Negation, tense, and clausal architecture*, 87–126. Washington, DC: Georgetown University Press.
- Merchant, Jason. 2001. *The syntax of silence*. Oxford: Oxford University Press.
- Merchant, Jason. 2004. Fragments and ellipsis. *Linguistics and Philosophy* 27(6). 661–738.
- Merchant, Jason. 2008. Variable island repair under ellipsis. In Kyle Johnson (ed.), *Topics in ellipsis*, 132–53. Cambridge, England: Cambridge University Press.
- Merchant, Jason. 2010. Three kinds of ellipsis: syntactic, semantic, pragmatic? In François Recanati, Isidora Stojanovic & Neftail Villanueva (eds.), *Context-dependence, perspective, and relativity*, 141–92. Berlin: Mouton de Gruyter.

- Merchant, Jason. 2013. Polarity items under ellipsis. In Lisa Lai shen Cheng & Norbert Corver (eds.), *Diagnosing syntax*, 441–62. Oxford: Oxford University Press.
- Miller, Philip & Geoffrey K. Pullum. 2013. Exophoric VP ellipsis. In *The core and the periphery: data-driven perspectives on syntax inspired by Ivan A. Sag*, 5–32. Stanford: CSLI Publications.
- Montague, Richard. 1973. The proper treatment of quantification in ordinary English. In J. Hintikka, J. Moravcsik & P. Suppes (eds.), *Approaches to natural language*, 221–42. Dordrecht: Reidel.
- Morgan, Jerrold. 1973. Sentence fragments and the notion ‘sentence’. In *Issues in linguistics: Papers in honor of Henry and Renée Kahane*, Urbana, IL: University of Illinois Press‘.
- Napoli, Donna Jo. 1982. Initial material deletion in English. *Glossa* 16(1). 85–111.
- Nunes, Jairo. 2004. *Linearization of chains and sideward movement*. Cambridge, MA: MIT Press.
- Oehrle, Richard. 1987. Boolean properties in the analysis of gapping. In Geoffrey J. Huck & Almerindo E. Ojeda (eds.), *Syntax and semantics 20: Discontinuous constituency*, 203–40. San Diego: Academic Press, Inc.
- Ono, Hajime. 2006. *An investigation of exclamatives in English and Japanese: syntax and sentence processing*. University of Maryland, College Park dissertation.
- Partee, Barbara H. 1989. Many quantifiers. In Joyce Powers & Kenneth de Jong (eds.), *ESCOL 89: Proceedings of the Eastern States Conference on Linguistics*, 383–402. Columbus, OH: Department of Linguistics, Ohio State University.
- Partee, Barbara H. 1991. Topic, focus and quantification. In Steven K. Moore & Adam Zachary Wyner (eds.), *Proceedings of SALT 1*, 159–88. Ithaca, NY: Cornell University.
- Partee, Barbara H. 1999. Focus, quantification, and semantics-pragmatics issues. In P. Bosch & R. van der Sandt (eds.), *Focus: Linguistic, cognitive and computational perspectives*, 213–31. Cambridge, England: Cambridge University Press.
- Penka, Doris. 2011. *Negative indefinites*. Oxford: Oxford University Press.
- Penka, Doris. 2012. Split scope of negative indefinites. *Language and Linguistics Compass* 6(8). 517–32.
- Pesetsky, David. 1987. WH-in-situ: Movement and unselective binding. In Eric Reuland & Alice G. B. ter Meulen (eds.), *The linguistic representation of (in)definiteness*, Cambridge, MA: MIT Press.

- Pesetsky, David. 1997. Optimality Theory and syntax: Movement and pronunciation. In Diana Archangeli & D. Terence Langendoen (eds.), *Optimality Theory: an overview*, Oxford: Blackwell.
- Pollman, T. 1975. Een regel die subject en copula deletert? *Spektator* 5. 282–92.
- Portner, Paul. 2004. The semantics of imperatives within a theory of clause types. In K. Watanabe & Robert B. Young (eds.), *Proceedings of SALT 14*, Ithaca, NY: CLC Publications, Cornell University.
- Postal, Paul M. 1993. Remarks on weak crossover effects. *Linguistic Inquiry* 24(3). 539–56.
- Postal, Paul M. 1998. *Three investigations of extraction*. Cambridge, MA: MIT Press.
- Postal, Paul M. 2003. The structure of one type of American English vulgar minimizer. In *Skeptical linguistic essays*, chap. 5, 159–72. New York: Oxford University Press.
- Potts, Christopher. 2000. When even *no*'s Neg is Splitsville. In Sandra Chung, James McCloskey & Nathan Sanders (eds.), *The Jorge Hankamer Web Fest*, .
- Prince, Ellen F. 1981. Topicalization, focus-movement, and Yiddish-movement: a pragmatic differentiation. In *Proceedings of BLS 7*, 249–64. Berkeley, CA: Berkeley Linguistics Society.
- Pullum, Geoffrey K. 2000. Hankamer was! In Sandra Chung, James McCloskey & Nathan Sanders (eds.), *The Jorge Hankamer Web Fest*, <http://ling.ucsc.edu/Jorge/pullum.html>.
- Rawlins, Kyle. 2008. *(Un)conditionals: an investigation in the syntax and semantics of conditional structures*. University of California Santa Cruz dissertation.
- Rawlins, Kyle. 2013. (Un)conditionals. *Natural Language Semantics* 40. 111–78.
- Reich, Ingo. 2007. Toward a uniform analysis of short answers and gapping. In Kerstin Schwabe & Susanne Winkler (eds.), *On information structure, meaning and form*, 467–84. Amsterdam: John Benjamins.
- Rett, Jessica. 2008. *Degree modification in natural language*. Rutgers University dissertation.
- Rett, Jessica. 2011. Exclamatives, degrees and speech acts. *Linguistics and Philosophy* 34. 411–42.
- Richards, Norvin. 1997. *What moves where when in which language?* Massachusetts Institute of Technology dissertation.
- Richards, Norvin. 2001. *Movement in language: interactions and architectures*. New York: Oxford University Press.

- Rizzi, Luigi. 1990. *Relativized minimality*. Cambridge, MA: MIT Press.
- Rizzi, Luigi. 1997. The fine structure of the left periphery. In Liliane Haegeman (ed.), *Elements of grammar: handbook of generative syntax*, 281–337. Dordrecht: Kluwer.
- Roberts, Craige. 2012/1996. Information structure in discourse: towards an integrated formal theory of pragmatics. *Semantics & Pragmatics* 5. 1–69.
- Rodrigues, Cilene, Andrew Nevins & Luis Vicente. 2009. Cleaving the interactions between sluicing and preposition stranding. In Danièle Torck & W. Leo Wetzels (eds.), *Romance Languages and Linguistic Theory 2006*, 175–98. Amsterdam: John Benjamins.
- Rooryck, Johan. 2001. Evidentiality, part I. *GLOT International* 5. 125–33.
- Rooth, Mats. 1985. *Association with focus*. University of Massachusetts Amherst dissertation.
- Rooth, Mats. 1992a. Ellipsis redundancy and reduction redundancy. In Steve Berman & Arild Hestvik (eds.), *Proceedings of the Stuttgart Ellipsis Workshop*, Stuttgart.
- Rooth, Mats. 1992b. A theory of focus interpretation. *Natural Language Semantics* 1(1). 75–116.
- Ross, John Robert. 1969. Guess who? In Robert Binnick, Alice Davison, Georgia Green & Jerry Morgan (eds.), *Proceedings of CLS 5*, 252–86. Chicago: Chicago Linguistic Society.
- Rullman, Hotze. 1995. Geen eenheid. *Tabu* 25(4). 194–7.
- Sag, Ivan. 1976. *Deletion and logical form*. Massachusetts Institute of Technology dissertation.
- Sailor, Craig & Gary Thoms. 2014. On the non-existence of non-constituent coordination and non-constituent ellipsis. In Robert LaBarge (ed.), *Proceedings of WCCFL 31*, Somerville, MA: Cascadilla Press.
- Sauerland, Uli & Paul Elbourne. 2002. Total reconstruction, PF movement, and derivational order. *Linguistic Inquiry* 33(2). 283–319.
- Schachter, Paul. 1977. Does she or doesn't she? *Linguistic Inquiry* 8(4). 763–7.
- Schank, Roger & Robert Abelson. 1977. *Scripts, plans, goals, and understanding: an inquiry into human knowledge structures*. Hillsdale, NJ: Lawrence Erlbaum Associates.
- Schlenker, Phillippe. 2003. A plea for monsters. *Linguistics and Philosophy* 26. 29–120.
- Schwager, Magdalena. 2005. *Interpreting imperatives*. Universität zu Frankfurt am Main dissertation.
- Schwarzschild, Roger. 1999. GIVENness, AvoidF and other constraints on the placement of accent. *Natural Language Semantics* 7. 141–77.

- Searle, John. 1969. *Speech acts*. Cambridge, England: Cambridge University Press.
- Selkirk, Elisabeth. 2011. The syntax-phonology interface. In John Goldsmith, Jason Riggle & Alan C. L. Yu (eds.), *The handbook of phonological theory, second edition*, Oxford: Wiley-Blackwell.
- Servidio, Emilo. 2013. Contrastive topics accommodate antecedents for ellipsis. Talk presented at the Identity in Ellipsis workshop, Universiteit Leiden, September 20–21.
- Sharvit, Yael. 1999. Functional relative clauses. *Linguistics and Philosophy* 22(5). 447–78.
- Snyder, William. 1992. *Wh*-extraction and the lexical representation of verbs. Ms. Massachusetts Institute of Technology. [http://web.uconn.edu/snyder/papers/Snyder\\_1992\\_Wh\\_V.pdf](http://web.uconn.edu/snyder/papers/Snyder_1992_Wh_V.pdf).
- Speas, Margaret. 2004. Evidentiality, logophoricity, and the syntactic representation of pragmatic features. *Lingua* 114. 255–76.
- Sportiche, Dominique. 1988. A theory of floating quantifiers and its corollaries for constituent structure. *Linguistic Inquiry* 19. 425–49.
- Stainton, Robert J. 1998. Quantifier phrases, meaningfulness “in isolation”, and ellipsis. *Linguistics and Philosophy* 21. 311–40.
- Stainton, Robert J. 2005. In defense of non-sentential assertion. In Zoltán Gendler Szabó (ed.), *Semantics versus pragmatics*, 383–457. Oxford: Oxford University Press.
- Stainton, Robert J. 2006a. Neither fragments nor ellipsis. In Ljiljana Progovac, Kate Paesania, Eugenia Casielles & Ellen Barton (eds.), *The syntax of nonsententials*, 93–116. Philadelphia: John Benjamins.
- Stainton, Robert J. 2006b. *Words and thoughts: subsentences, ellipsis, and the philosophy of language*. Oxford: Oxford University Press.
- Stalnaker, Robert. 1978. Assertion. In Peter Cole (ed.), *Syntax and semantics* 9, 315–32. New York: Academic Press.
- Stanley, Jason. 2000. Context and logical form. *Linguistics and Philosophy* 23. 391–434.
- Stanley, Jason & Zoltán Gendler Szabó. 2000. On quantifier domain restriction. *Mind and Language* 15(2–3). 219–61.
- Suñer, Margarita. 1991. Indirect questions and the structure of CP: some consequences. In Héctor Campos & Fernando Martínez-Gil (eds.), *Current studies in Spanish linguistics*, 283–312. Washington, DC: Georgetown University Press.
- Suñer, Margarita. 1993. About indirect questions and semi-questions. *Linguistics and Philosophy* 16(1). 45–77.

- Takahashi, Shoichi. 2004. Pseudogapping and cyclic linearization. In Matthew Wolf & Keir Moulton (eds.), *Proceedings of NELS 34*, 571–85. Amherst, MA: GLSA.
- Takahashi, Shoichi & Danny Fox. 2005. MaxElide and the re-binding problem. In Efthymia Georgala & Jonathan Howell (eds.), *Proceedings of SALT 15*, 223–40. Ithaca, NY: Cornell University.
- Tancredi, Christopher. 1992. *Deletion, deaccenting and presupposition*. Massachusetts Institute of Technology dissertation.
- Temmerman, Tanja. 2013a. *Multidominance, ellipsis and quantifier scope*. Universiteit Leiden dissertation.
- Temmerman, Tanja. 2013b. The syntax of Dutch embedded fragment answers: on the PF-theory of islands and the WH/slucing correlation. *Natural Language and Linguistic Theory* 31(1). 235–85.
- Thoms, Gary. 2010. ‘Verb-floating’ and VP-ellipsis: towards a movement account of ellipsis licensing. *Linguistic Variation Yearbook* 10. 252–97.
- Thoms, Gary. 2013. Lexical mismatches in ellipsis and the identity condition. In Stefan Keine & Shayne Sloggett (eds.), *Proceedings of NELS 42*, 559–72. Amherst, MA: GLSA.
- Toosarvandani, Maziar. 2013. Gapping is low coordination (plus VP-ellipsis): A reply to Johnson. Ms. University of California, Santa Cruz.
- Valmala, Vidal. 2007. The syntax of little things. Paper presented at the 17th Colloquium on Generative Grammar, Girona, June 2007. <http://linguistics.huji.ac.il/IATL/23/Valmala.pdf>.
- Vicente, Luis. 2013. In search of a missing clause. Handout from presentation at DGfS 35. <http://www.luisvicente.net/papers/vicente---in-search-of-a-missing-clause.pdf>.
- Vikner, Sten. 1991. *Verb movement and the licensing of NP-positions in the Germanic languages*. University of Geneva dissertation.
- Vikner, Sten. 1995. *Verb movement and expletive subjects in the Germanic languages*. Oxford: Oxford University Press.
- Weir, Andrew. 2012. Left-edge deletion in English and subject omission in diaries. *English Language and Linguistics* 16(1). 105–29.
- Weir, Andrew. to appear. Why-stripping targets Voice Phrase. In Hsin-Lun Huang, Amanda Rysling & Ethan Poole (eds.), *Proceedings of NELS 43*, Amherst, MA: GLSA.
- Westerståhl, Dag. 1985. Determiners and context sets. In Johan van Benthem & Alice ter Meulen (eds.), *Generalized quantifiers in natural language*, 45–71. Dordrecht: Foris.

- Wurmbrand, Susi. 2000. The structure(s) of particle verbs. Ms. University of Connecticut. <http://wurmbrand.uconn.edu/Papers/structure-particles.pdf>.
- Yoshida, Masaya, Chizuru Nakao & Ivan Ortega-Santos. 2013. The syntax of *why*-stripping. To appear in *Natural Language and Linguistic Theory*.
- Zaefferer, Dietmar. 1990. Conditionals and unconditionals in universal grammar and situation semantics. In Robin Cooper, Kuniaki Mukai & John Perry (eds.), *Situation theory and its applications I*, 471–92. Stanford: CSLI Publicationsn.
- Zaefferer, Dietmar. 1991. Conditionals and unconditionals: Cross-linguistic and logical aspects. In Dietmar Zaefferer (ed.), *Semantic universals and universal semantics*, 210–36. Dordrecht: Foris.
- Zanuttini, Raffaella & Paul Portner. 2003. Exclamative clauses: at the syntax-semantics interface. *Language* 79(1). 39–81.