

THE UNIVERSITY OF CHICAGO

INFLECTIONAL DEPENDENCIES. A STUDY OF COMPLEX VERBAL EXPRESSIONS IN  
NDEBELE

A DISSERTATION SUBMITTED TO  
THE FACULTY OF THE DIVISION OF THE HUMANITIES  
IN CANDIDACY FOR THE DEGREE OF  
DOCTOR OF PHILOSOPHY

DEPARTMENT OF LINGUISTICS

BY

JOANNA PIETRASZKO

CHICAGO, ILLINOIS

AUGUST 2017

Copyright © 2017 by Joanna Pietraszko  
All Rights Reserved

Rodzicom

# TABLE OF CONTENTS

ACKNOWLEDGMENTS . . . . .	vii
ABSTRACT . . . . .	ix
LIST OF GLOSSING CONVENTIONS . . . . .	x
<b>1 INTRODUCTION . . . . .</b>	<b>1</b>
1.1 Multi-verb constructions and the extended projection . . . . .	2
1.2 The verbal category and a typology of verbs . . . . .	5
1.3 Inflectional dependencies: Infl-agreement and c-selection . . . . .	8
1.4 Organization of the thesis . . . . .	10
<b>2 BASIC ASPECTS OF NDEBELE MORPHOSYNTAX . . . . .</b>	<b>13</b>
2.1 Basics . . . . .	13
2.2 Head movement and word formation . . . . .	16
2.3 Word order and agreement . . . . .	22
<b>3 AUXILIARY VERBS AS NON-PROJECTING VERBS . . . . .</b>	<b>25</b>
3.1 Introduction . . . . .	25
3.2 The limited-projection problem . . . . .	31
3.2.1 The lack of argument structure domain . . . . .	32
3.2.2 No regular negation marking . . . . .	43
3.2.3 Non-projecting verbs: a theoretical challenge . . . . .	48
3.3 The selection problem . . . . .	52
3.3.1 Deriving selectional patterns from Infl-agreement . . . . .	52
3.3.2 Prediction 1: the extent of selectional optionality . . . . .	59
3.3.3 Prediction 2: possible cooccurrences of aspectual auxiliaries . . . . .	62
3.4 The overflow problem . . . . .	64
3.5 A formal representation of non-projecting verbs . . . . .	68
3.5.1 The category of non-projecting verbs . . . . .	69
3.5.2 Auxiliaries are verbal in Ndebele . . . . .	76
3.6 Conclusion . . . . .	81
<b>4 DEFAULT PERIPHRAISIS AND THE INSERTION APPROACH . . . . .</b>	<b>83</b>
4.1 Introduction . . . . .	83
4.2 Default periphrasis as a repair strategy . . . . .	84
4.2.1 Main arguments for the insertion approach . . . . .	84
4.2.2 The failure and the repair . . . . .	88
4.3 The Repair Question: Auxiliary insertion as selection-triggered Merge . . . . .	91
4.3.1 Cyclic Selection in a functional hierarchy . . . . .	91
4.3.2 Auxiliary insertion as the result of Cyclic Selection . . . . .	98
4.3.3 Advantages over alternative approaches to the Repair Question . . . . .	105

4.4	Deriving the overflow pattern in Ndebele . . . . .	108
4.4.1	The interaction between V-selection and Infl-agreement: deriving imper- fective tenses . . . . .	109
4.4.2	An extension to perfect and prospective tenses: a lower T . . . . .	118
4.5	Against configurational approaches to the Failure Question . . . . .	134
4.5.1	Head-movement and Infl-agreement (Bjorkman, 2011) . . . . .	134
4.5.2	Lack of head movement triggering auxiliary insertion . . . . .	145
4.6	Conclusion . . . . .	156
5	LEXICAL LIGHT VERBS AND SELECTION . . . . .	158
5.1	Introduction . . . . .	158
5.2	The syntax of lexical-LV constructions . . . . .	162
5.2.1	The functional–lexical dichotomy . . . . .	163
5.2.2	The size of lexical LVs’ complement . . . . .	185
5.3	Deriving participial and subjunctive morphology in LV constructions . . . . .	189
5.3.1	Against a selection-based account . . . . .	191
5.3.2	Subjunctive morphology as a reflex of <i>dependent valuation</i> . . . . .	194
5.3.3	Independent evidence for dependent valuation: tense agreement . . . . .	199
5.4	Subjunctive vs infinitives: the role of c-selection . . . . .	203
5.4.1	Patterns of selectional variability . . . . .	205
5.4.2	Explaining the infinitive–CP correlation: a DP-shell hypothesis . . . . .	208
5.5	Conclusion . . . . .	216
6	EXTENSIONS OF THE THEORY . . . . .	219
6.1	Introduction . . . . .	219
6.2	Inflectional categories and metacategories . . . . .	220
6.2.1	Positional licensing of Ndebele mood forms . . . . .	224
6.2.2	Cooccurrence of categories and metacategories . . . . .	236
6.2.3	Metacategories are irrelevant to inflectional periphrasis . . . . .	241
6.2.4	Metacategories have a predictable distribution . . . . .	243
6.2.5	Conclusion . . . . .	249
6.3	V-chains and the distribution of $\varphi$ -agreement . . . . .	250
6.3.1	The inconsistent distribution of $\varphi$ -probes . . . . .	250
6.3.2	A $\varphi$ -probe on top of every V-chain . . . . .	255
6.3.3	Further predictions: agreement in LV-constructions . . . . .	260
6.3.4	Remaining questions . . . . .	267
6.4	Conclusion . . . . .	271
7	CONCLUSION . . . . .	273
7.1	Main questions and answers: a summary . . . . .	273
7.1.1	Multi-verbal syntax and the Extended Projection Hypothesis . . . . .	273
7.1.2	The nature of auxiliary insertion . . . . .	275
7.1.3	Morphological selection in multi-verb constructions . . . . .	277
7.2	Final thoughts of inflectional dependencies: Infl-agreement and V-selection . . . . .	278

7.2.1	Infl-agreement . . . . .	278
7.2.2	V-selection . . . . .	281
REFERENCES	. . . . .	285

## ACKNOWLEDGMENTS

I want to thank my dissertation committee: Karlos Arregi, John Goldsmith and Jason Merchant. Each of them has taught me different but equally important lessons.

I am especially indebted to Karlos Arregi for his unwavering support and for sharing so much of his knowledge, insight and wisdom with me. No words are powerful enough to express just how lucky I feel to have had Karlos as my advisor, mentor and friend.

Fieldwork has been an invaluable experience and I want to thank all those who helped me carry it out: Karlos Arregi, Laura Downing, Lenore Grenoble, Claire Halpert, Langa Khumalo, Doreen Mlambo, Salikoko Mufwene, Jack Shepherd, Galen Sibanda and Jochen Zeller. I'm grateful to Lily Dubé, my first Ndebele consultant, who also taught me so much about the language, as well as all my other consultants in the US and South Africa. This research was supported by National Science Foundation (BCS-1551787) and by the University of Chicago Rella Cohn Fund.

During my grad-school years, I met many excellent people who helped me, encouraged me and approached me as friends. I want to thank Amy Dahlstrom, Itamar Francez, Anastasia Giannakidou, Lenore Grenoble, Brent Henderson, Chris Kennedy, Langa Khumalo, Deo Ngonyani, David Pesetsky, Galen Sibanda, Ming Xiang, Alan Yu and Jochen Zeller. I'm grateful to my first linguistics teachers at the University of Wrocław: professor Bożena Rozwadowska, Joanna Błaszczak, Dorota Klimek-Jankowska and Krzysztof Migdalski for introducing me to the joys of grammar.

I'm grateful to my fellow CLS officers: Helena Aparicio, Gallagher Flinn, Katie Franich and Tamara Vardomsкая – I will remember the countless meetings we had fondly. Many thanks to my other fellow students and friends at UChicago: Andrea Beltrama, Ryan Bochnak, Ksenia Ershova, Jacob Phillips, Julian Grove, Jeff Geiger, Peet Klecha, Martina Martinović and Adam Singerman. My dear Emily, I will miss you, but I'm also incredibly happy that we got to overlap by 5 years!

I owe so much to my aunt Lidia – my childhood mentor, who taught me all the case endings and found my questions interesting. I'm grateful for my brother's jokes and optimism. They always make my heart lighter. Iza, Doda and Mirek, thank you for your friendship. Takich dwóch jak was

trzech nie ma ani jednego.

Writing a dissertation is a process during which occasional crises seem inevitable. Fortunately, I had two wonderful companions who helped me avert many of them. Thank you, Omer, for always having a smile, a hug and a happy thought for me. And thank you little Sprocket pup, for the perfect snuggle spot that your furry forehead is.

Dear mom and dad, I dedicate this work to you. It is the outcome of your constant encouragement, love and trust that you've had in me.



## ABSTRACT

This thesis is a study of the syntax of multi-verb constructions, in which a single clause contains more than one verbal element. Multi-verb constructions are of special interest in light of the hypothesis that clausal structure is headed by a verb. Implemented in terms of extended projections, this hypothesis states that clausal functional structure is the extended projection of a verb. A full understanding of multi-verbal constructions, in which there is no one-to-one verb–clause mapping, relies on refinements of the intimate relation between clause structure and the verbal category. Analyzing various types of multi-verb constructions in Ndebele, a Bantu language of Zimbabwe, I propose a theory multi-verbal syntax which makes explicit the ways in which a single extended projection may contain more than one verb. I propose a basic distinction within the verbal category into *projecting verbs* and *non-projecting verbs*. Projecting verbs have the ability to head a full clause and are what we typically think of as lexical verbs. Non-projecting verbs, on the other hand, are inherently unable to project full clausal structure. There are two types of non-projecting verbs in Ndebele. *Aspectual auxiliaries* are lexical items whose category feature has mixed properties: it has properties of both a lexical verb and some functional head in the clausal spine. The mixed properties are detected by different aspects of their syntax. The second type of non-projecting verb is the default auxiliary (*be*, in Ndebele), used in compound tenses. The default auxiliary is a verbal expletive, which becomes part of the derivation via last-resort selection. Any multi-verbal construction with more than one lexical (projecting) verb necessarily contains more than one extended projection. Additionally, the thesis is concerned with the role of two syntactic dependencies in the inflectional domain: agreement and selection. Both relations are involved in determining the morphological shape of multi-verb constructions by posing restrictions on the form, category and size of the main lexical verb. Depending on the light/auxiliary verb, it can be a participle (imperfective, past or future), have a subjunctive form (present or past), or be infinitival/clausal. It is argued that such cooccurrence patterns are largely predictable from clause structure and agreement. Selection is involved only in a small set of idiosyncratic cases of complement selection.

## LIST OF GLOSSING CONVENTIONS

1	class 1
1s	class 1 subject agreement
1o	class 1 object agreement
1sg.s	first person singular subject agreement
1sg.o	first person singular object agreement
ACC	accusative
APPL	applicative
AUG	augment vowel
AUX	auxiliary verb
CNJ	conjoint
COMP	complementizer
DPST	distant past tense
DSJ	disjoint
FS	final suffix
FUT	future tense
IMPF	imperfective aspect
IND	indicative mood
INF	infinitive
MASC	masculine
NEG	negation
PASS	passive
PERF	perfect aspect
PRIN	principal mood
PROG	progressive aspect
PRON	pronoun

PST past tense  
PTCP participle  
RPST resented past tense  
SBJV subjunctive mood  
Q question particle

# CHAPTER 1

## INTRODUCTION

In this thesis, I investigate the verbal category, extended projections and syntactic dependencies in the inflectional domain. Examining multi-verb constructions in Zimbabwean Ndebele, I address the questions of verbal periphrasis, the nature of auxiliary/light verbs and the role of agreement and selection in the formation of complex verbal expressions.

I use the term *multi-verb construction* to refer to a mono-clausal structure with more than one verbal element. In addition to the *main verb*, introducing the lexical meaning of the verb and its argument structure, multi-verb constructions contain an additional verb, an *auxiliary/light verb*, which is associated with meanings related to tense, aspect or various adverbial meanings. I classify multi-verb constructions in Ndebele in three types, which differ in the type of auxiliary/light verb involved. *Compound tenses* are multi-verb constructions formed with the *default auxiliary* ‘be’. The other two types involve light verbs with meanings typical of adverbs in Indo-European languages. Some of these adverb-like verbs combine with participles – I call them *aspectual auxiliaries*, and others take subjunctive verb forms as their complement. I call the latter type *lexical light verbs*. All three types are illustrated below (1).

(1) Three types of multi-verb constructions in Ndebele

- |    |                           |                      |                            |
|----|---------------------------|----------------------|----------------------------|
| a. | U-za- <b>be</b>           | u-pheka              | <i>default auxiliary</i>   |
|    | 1sg.s-FUT-AUX             | 2sg.s-cook.IMPF.PTCP |                            |
|    | ‘You will be cooking’     |                      |                            |
| b. | U-se                      | u-phekile            | <i>aspectual auxiliary</i> |
|    | 2sg.s-already             | 2sg.s-cook.PST.PTCP  |                            |
|    | ‘You have already cooked’ |                      |                            |
| c. | U- <b>qala</b>            | u-pheke              | <i>lexical light verb</i>  |
|    | 2sg.s-first               | 2sg.s-cook.SBJV      |                            |
|    | ‘You first cook’          |                      |                            |

In the following sections, I describe the basic theoretical questions addressed in this thesis: the

challenges posed by multi-verb constructions for the theory of clausal structure as the extended projection of a verb (section 1.1), the nature of the verbal category and the typology of verbal elements (section 1.2), and the syntactic dependencies in the inflectional domain which regulate multi-verbal syntax (section 1.3). In the last section, I lay out the structure of the thesis and provide a brief summary of chapters.

## 1.1 Multi-verb constructions and the extended projection

Multi-verb constructions like the ones in (1) are of special interest for the theory of verbal extended projection (in the sense of Grimshaw (1991, 2000)). A prominent hypothesis in the recent developments of syntactic theory has been the idea that clausal structure is composed of a number of functional categories which themselves are a property of the verbal category – they constitute the verb’s extended projection. I refer to this as the *Extended Projection Hypothesis* (2).

### (2) *The Extended Projection Hypothesis*

Clausal functional structure is the extended projection of a verb.

Clausal structure understood in this way has been claimed to be universally fixed, and it is often referred to as the *clausal spine*, the (verbal) Functional Hierarchy (Cinque, 1998, 1999) or a Hierarchy of Projection (Adger & Svenonius, 2011). An example of (a fragment of) the verbal extended projection is shown in (3).

### (3) [TP [PerfP [AspP [VoiceP [vP [VP ]]]]]]]

The core idea behind the Extended Projection Hypothesis is that the functional categories in (3) are a property of the verbal category; they are what sets verbs apart from nouns, for example, whose extended projection looks quite different. What it means to be a verb is, among other things, to be able to project clausal structure.

In this light, a question arises about constructions in which apparently a single clausal spine contains more than one verbal element. If a single extended projection can contain more than one verb, the Extended Projection Hypothesis must be amended in one of the two following ways. The first way is to complicate the verbal extended projection allowing optional VPs interspersed within the functional hierarchy. The alternative is to retain the fixed shape of clausal structure and accommodate a multiplicity of verbs in a different way. I reject the hypothesis that a single extended projection may contain more than one VP (4). In the theory of multi-verb constructions I propose, the structure below, where all FPs are part of a single extended projection, is impossible.

(4) An impossible structure:

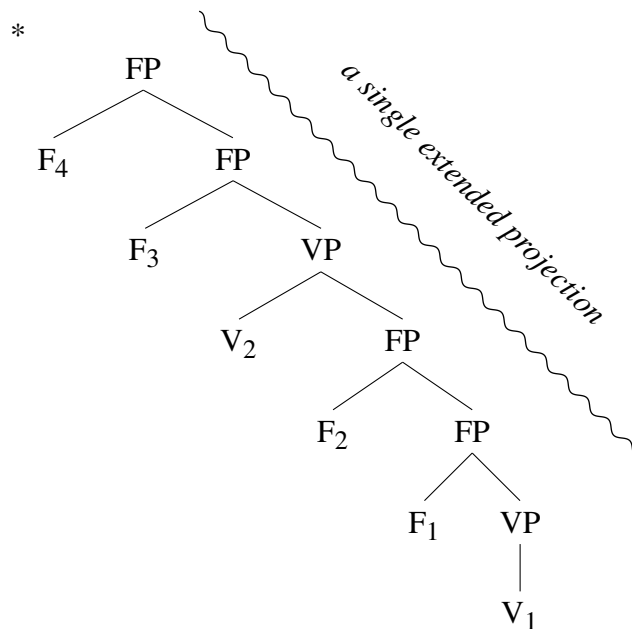

I argue that each of the three types of multi-verb constructions in Ndebele involves a different syntax, and that none of them can be characterized as a single extended projection with multiple VPs, as in (4). I propose that in multi-verb constructions built around a single clausal spine, only one verb projects and the other verb(s) are in some way associated with a specific functional head (5). If both verbs project a VP, the multi-verb construction necessarily contains two extended projections (6).

(5) A multi-verb construction with one extended projection

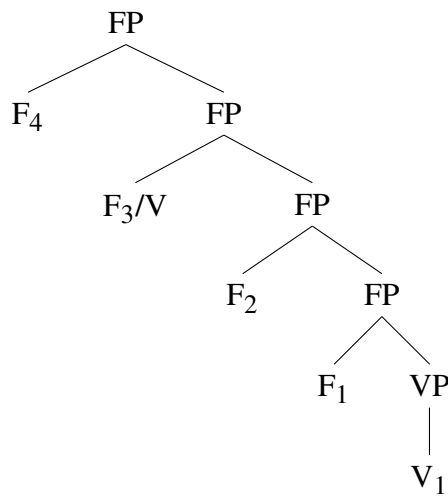

(6) A multi-verb construction with two extended projections

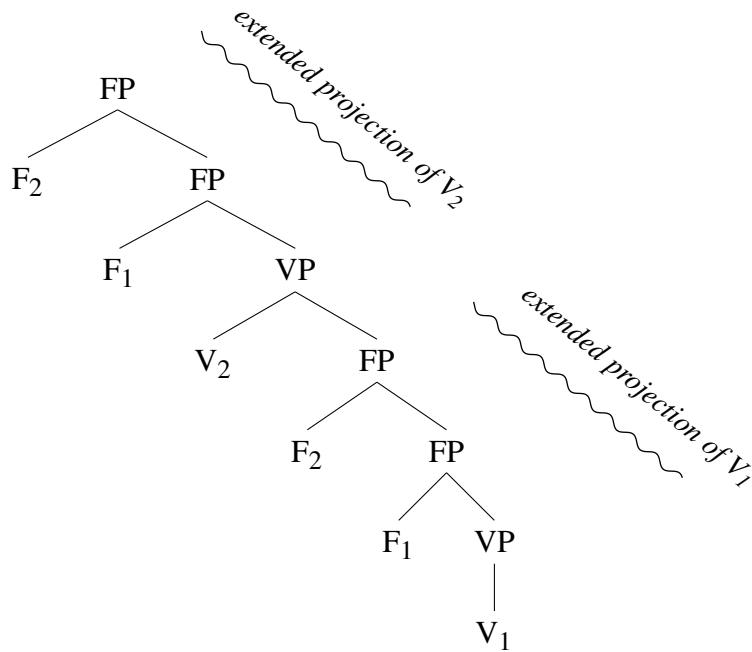

I show that both of the structures above are found in Ndebele: lexical light verb constructions involve two extended projections, as in (6). Compound tenses and aspectual-auxiliary constructions, on the other hand, are built around a single clausal spine, with auxiliary verbs being part of the main verb's extended projection. This characterization of auxiliary verbs raises an immediate question: what does it mean for a verb to be part of another verb's extended projection? Answering this question requires further consideration of the verbal category and I address it in the next subsection.

## 1.2 The verbal category and a typology of verbs

The basic typology of verbs emerging from this study is a classification into two types: *projecting verbs* and *non-projecting verbs*. Projecting verbs are what we often call *lexical verbs*, like 'cook' or 'play', but it is not the lexical meaning that is used here to distinguish them from non-projecting



verbs. Their defining property is the ability to project full clausal structure; in other words, to have a full extended projection. Non-projecting verbs, on the other hand, are elements of the verbal category which *systematically* lack the ability to project independent clausal structure. Throughout the thesis, I refer to non-projecting verbs as *auxiliary verbs* or *auxiliaries*.

- (7) a. **Projecting verbs:** verbal elements which can project full clausal structure  
b. **Non-projecting verbs:** verbal elements which can never project full clausal structure

The theory of multi-verbal syntax proposed in this thesis poses restrictions on what kind of verbs can cooccur in a single extended projection: a single extended projection contains at most one projecting verb; any additional verbal element must be a non-projecting verb. The presence of two projecting verbs in a multi-verb constructions entails the presence of two extended projections (though one of them may be reduced).

Since, according to this hypothesis, auxiliaries are part of another verb's extended projection, we need an understanding of how such verbs become part of the derivation. Put differently, in light of the Extended Projection Hypothesis, what does it mean to be a verb and be non-projecting?

I propose a formal typology of elements of the verbal category that allows for the existence of both projecting and non-projecting verbs. I adopt the formalization of category features where the value of CAT is an ordered pair of a category label, e.g. V or Asp, and a numerical value which specifies the category's position in the extended projection (Adger, 2010). The verbal extended projection in Ndebele is composed of the following categories (8).

- (8) Ndebele verbal functional hierarchy:  
 $\langle V,1 \rangle < \langle \text{Voice},2 \rangle < \langle \text{Asp},3 \rangle < \langle \text{Perf},4 \rangle < \langle T,5 \rangle$

The category of the main verb includes the category label V and a number 1 level specification, which means that it is the first element in the extended projection. The defining property of projecting verbs is being of category  $\langle V,1 \rangle$  – a verb which starts out an extended projection. I often refer

to elements of category  $\langle V,1 \rangle$  as *lexical verbs*. Non-projecting verbs are elements whose category label is V, but whose level value is not 1. I distinguish two types of non-projecting verbs. There are verbs whose level specification is higher than 1 – a level typical of higher, functional heads in the clausal spine. For instance, an element of category  $\langle V,3 \rangle$  is a verbal element associated with the aspectual functional level. This type of verb is what is often called a *functional verb* in the literature on compound tenses and restructuring (Cinque, 1999; Wurmbrand, 2004; Grano, 2012). The other type of non-projecting verb has the level specification 0. I propose that this is the category value of default auxiliaries, appearing in compound tenses, which I treat as verbal expletives – elements inserted in the structures as a last-resort way of satisfying a selectional V-feature on a functional head. This typology, summarized in (9)-(11) below, defines the three types of multi-verb constructions we find in Ndebele.

- (9) Lexical verb:                      (10) Aspectual auxiliary:      (11) Default auxiliary:
- $\left[ \text{CAT: } \langle V,1 \rangle \right]$                      
 $\left[ \text{CAT: } \langle V,3 \rangle \right]$                      
 $\left[ \text{CAT: } \langle V,0 \rangle \right]$

In lexical light verb constructions, both the main verb and the light verb are of category  $\langle V,1 \rangle$ , which means they both have their own extended projection (even though, as we will see, the projection of the main verb is reduced). The other two types of multi-verb constructions are formed with non-projecting verbs. Aspectual auxiliaries are functional verbs in the main verb’s extended projection, while default auxiliaries are used in compound tenses as verbal expletives.

The category feature of a verb plays an important role not only in determining the overall syntax of a multi-verb construction, but also in determining what syntactic dependencies obtain between verbs and other elements in the inflectional domain. I review these dependencies, as well as their consequences for verbal morphology, in the next section.

### 1.3 Inflectional dependencies: Infl-agreement and c-selection

We've seen in (1) (repeated below) that the form of the main verb can vary depending on what type of multi-verb construction it appears in. In the compound tense in (12-a), the main verb is an imperfective participle, in (12-b) it is a past participle, and in (12-c) – it has a subjunctive form.

(12) Three types of multi-verb constructions in Ndebele

- |    |                           |                      |                            |
|----|---------------------------|----------------------|----------------------------|
| a. | U-za- <b>be</b>           | u-pheka              | <i>default auxiliary</i>   |
|    | 2sg.s-FUT-AUX             | 2sg.s-cook.IMPF.PTCP |                            |
|    | 'You will be cooking'     |                      |                            |
| b. | U-se                      | u-phekile            | <i>aspectual auxiliary</i> |
|    | 2sg.s-already             | 2sg.s-cook.PST.PTCP  |                            |
|    | 'You have already cooked' |                      |                            |
| c. | U- <b>qala</b>            | u-pheke              | <i>lexical light verb</i>  |
|    | 2sg.s-first               | 2sg.s-cook.SBJV      |                            |
|    | 'You first cook'          |                      |                            |

An important aspect of analyzing multi-verb constructions is understanding the relation between two verbs which gives rise to such morphological variation. In this respect, I argue for a specific division of labor between agreement and selection in multi-verbal syntax. Agreement in inflectional features (Infl-features) and c-selection play different roles in i) determining the size and category of the auxiliary/light verb's complement, ii) in inflectional periphrasis – the process which gives rise to compound tenses and iii) in specifying the morphological form of the main verb. Below, I discuss each question in turn.

I argue that complement size and category are determined by selection only in the case of lexical light verbs. The other two constructions are formed with non-projecting verbs, which are part of the main verb's extended projection, and the size of their complement falls out directly from their position in the functional spine. I support this view by showing that only lexical light verbs exhibit some idiosyncrasy in selecting their complement; the complement size and category of non-projecting verbs is entirely predictable and therefore, I argue, c-selection does not play a

role in determining the complement of an auxiliary verb.

C-selection does play a role, an important one, in inflectional periphrasis, which results in the insertion of a verbal expletive – the default auxiliary. Building on previous work, I argue that default auxiliaries enter the derivation via last-resort insertion. I propose that this insertion is driven by the need to satisfy a selectional V-feature on an inflectional head. In this context, an interaction with Infl-agreement is crucial: selectional V-features on functional heads can be checked by the main verb as long as the main verb can participate in Infl-agreement. Insertion of an expletive verb takes place only if the main verb is inaccessible, rendering auxiliary insertion a last-resort operation.

Finally, Infl-agreement is responsible for regulating the morphology on the main verb in multi-verb constructions. For instance, an imperfective participle is a verb whose unvalued Infl-feature is valued by a head with Infl:IMPF. Similarly, past participles are the result of valuation by a head with Infl:PST. Crucially, selection plays no role in creating these dependencies. An argument against involving selection in this process is the lack of idiosyncratic relations and the fact that the extent of flexibility in inflectional morphology of the main verb is exactly what we predict from a relation based exclusively on Infl-agreement. The remaining question about main verb morphology concerns the distinction between participial and subjunctive forms. I argue that this type of morphology is not defined by specific morphosyntactic features (unlike the imperfective morphology, for example). Rather, participial and subjunctive forms are what I call *metacategories* – morphological forms licensed in specific syntactic configurations. Subjunctive forms, I argue, are triggered in inflectionally deficient contexts. Participial morphology, on the other hand, requires no special licensing; it is the elsewhere non-finite<sup>1</sup> verbal form.

---

1. "Finite verb" is to be understood here as referring to the highest verb in a tensed clause.

## 1.4 Organization of the thesis

The thesis is organized around the three types of multi-verb constructions, aspectual auxiliary constructions, compound tenses and lexical light verb constructions, analyzed in chapters 3, 4 and 5 respectively.

The next chapter, chapter 2, gives a background on Ndebele and provides an overview of the relevant aspects of its syntax and morphology.

In chapter 3, I take up the question of non-projecting verbs and argue that auxiliary verbs in Ndebele, both default and aspectual, have no extended projection of their own, i.e. no functional structure independent of the extended projection of the main verb. I compare three approaches to auxiliary verbs: i) the VP approach, according to which auxiliary verbs are verbs projecting VPs, ii) the FP approach, which treats auxiliaries as base generated in functional heads, and iii) the Insertion approach, based on the hypothesis that auxiliary verbs enter the derivation via a last-resort insertion mechanism. I argue that the VP approach gains no support from the typology of Ndebele multi-verb construction, and that both the FP and Insertion approach are needed – each of them specifies a different way in which a non-projecting verb can become part of the derivation, and instantiates a different type of multi-verb construction: an aspectual-auxiliary construction (the FP approach) and a compound tense (the Insertion approach). The chapter additionally provides a full account of aspectual auxiliaries in Ndebele.

Chapter 4 is devoted to compound tenses and the Insertion approach. I develop an account of default periphrasis in this vein, building on previous insights about default auxiliary insertion as a last-resort repair strategy. The repair strategy is typically thought of as the grammar's response to a disproportion between the number of inflectional categories and the number of inflection hosts, that is verbs. Taking this basic characterization of default periphrasis, I make two main claims. The first one has to do with the aspects of the grammar which prevent inflections from combining with the main verb. I propose that the failure of synthesis is caused directly by inflectional complexity (cooccurrences of certain inflectional categories) and is not regulated by other processes, such as

head movement. And second, I argue that the process of auxiliary insertion should be understood in terms of a general relationship between verbs and inflections that gives rise to both synthesis and periphrasis. Following earlier work by Cowper (2010), I propose that this relation is c-selection. A failure to check a selectional V-feature by the main verb causes last-resort selection of a verbal expletive – the default auxiliary.

Chapter 5 completes the typology of multi-verb constructions by analyzing the third type – a construction in which both the light verb and the main verb are lexical, i.e. projecting verbs. One of the main objections to the VP approach to auxiliary verbs discussed in chapter 3 is the problem of limited-projection: under this approach, it is unclear why certain verbs can project as far as a VP but systematically lack higher functional projections. What we learn from lexical light verb constructions is that light verbs which indeed project a VP can also project full clausal structure. In other words, there are no verbs with *obligatorily* reduced projections, in any sense different from how non-projecting verbs are defined.

In chapter 6, I discuss two topics that extend from the core part of the thesis. First, I address the question of verbal morphology and its relationship to the verb's syntactic context. I propose a classification of verbal morphology into *inflectional categories* (e.g. past tense or imperfective aspect) and *metacategories* (in Ndebele they include principal and subjunctive mood forms, as well as participial morphology). Inflectional categories correspond to morphosyntactic features, in particular Infl-features. Metacategories, on the other hand, are defined positionally: the principal form is the morphology found on the highest verb in an indicative clause, subjunctive morphology is licensed in inflectionally deficient contexts (specifically, in the immediate context of an unvalued Infl-feature), while participial morphology is the elsewhere verbal form. The second question taken up in this chapter concerns the distribution of subject agreement prefixes in the Ndebele clause, and especially in multi-verb constructions. I first show that it is very difficult to identify functional heads which are consistently associated with a  $\varphi$ -probe. I then provide a theoretically framed generalization about their distribution: a  $\varphi$ -probe is associated with the highest head of a head-

chain created by the selectional V-checking relation – a mechanism independently needed in the derivation of default periphrasis.

## CHAPTER 2

### BASIC ASPECTS OF NDEBELE MORPHOSYNTAX

This chapter is a brief overview of certain aspects of Ndebele syntax and morphology. I describe the grammatical phenomena which will be of relevance in the following chapters and lay out my assumptions about word formation, word order and agreement.

#### 2.1 Basics

Ndebele (isiNdebele, Northern Ndebele) is a southern Bantu language of the Nguni family, which includes e.g. Zulu, Xhosa, Swati or Transval Ndebele. It is spoken primarily in Zimbabwe, in particular in its western region of Matabeleland, by 1.6 million people. Ndebele is a very close relative of Zulu – the two languages have only about two hundred years of independent history. Despite being less thoroughly studied than its South African cousin, various aspects of Ndebele grammar have been described and analyzed in works such as Pelling (1966), Rycroft (1983), Rycroft (1980), Downing (1990), Hyman et al. (1999), Sibanda (2004), Khumalo (2007), Mawadza (2009) and Cook (2013). Unless explicitly indicated, all Ndebele data in this thesis come from my independent fieldwork.

Ndebele is a tonal language, with a high vs toneless opposition (Sibanda, 2004). Throughout the thesis, I do not mark tone in the examples, unless the tonal contrasts are relevant. The basic template of a Ndebele verb is shown in (1): the first morpheme in a verb is typically a subject agreement prefix, followed by a tense marker (which can be null), an object marker, the lexical root, optional derivational suffixes (e.g. applicative, causative, passive) and the so called Final Suffix.<sup>1</sup> An example illustrating the template in (1) is given in (2).

---

1. The Final Suffix is often referred to in the Bantu literature as the Final Vowel, as it typically consists of just a vowel. This is, however, not always the case in Ndebele and for this reason the term Final Suffix is more appropriate.



(1) VERB MORPHOLOGY TEMPLATE:

AgrS–Tense–(AgrO)–Root–(Derivation)–Final Suffix

- (2) Ngi- za- ku- phék -el -a.  
1sg.s- FUT- 2sg.o- cook -APPL -FS  
'I will cook for you.'

As we see in (2), Ndebele is to a considerable extent an agglutinative language. Nonetheless, it also makes use of analytic, or periphrastic, expressions in the verbal domain. For instance, Ndebele has a number of compound tenses, which involve the auxiliary verb *be* and a participle. In (3), I illustrate compound tenses in Ndebele with a Future Imperfective tense, and a Past Imperfective tense.

(3) Examples of compound tenses in Ndebele

- |    |                       |                      |                            |
|----|-----------------------|----------------------|----------------------------|
| a. | U-za-be               | u-phéka              | <i>Future Imperfective</i> |
|    | 2sg.s-FUT-AUX         | 2sg.s-cook.IMPF.PTCP |                            |
|    | 'You will be cooking' |                      |                            |
| b. | U-∅-be                | u-phéka              | <i>Past Imperfective</i>   |
|    | 2sg.s-PST-AUX         | 2sg.s-cook.IMPF.PTCP |                            |
|    | 'You were cooking'    |                      |                            |

As examples of compound tenses recur throughout the thesis, it is worth keeping in mind a morphophonological process which deletes subject agreement prefixes in some of them. Note that both the auxiliary and the participle in (1) are inflected for subject agreement. Typically, both agreement prefixes are overt, with one exception. In a compound tense where the tense morpheme is null, as in (3-b), the subject agreement prefix on the auxiliary can only surface if it is a vowel, like in (3-b). If the subject agreement prefix in this same context is of the form CV, it undergoes deletion, as we see in (4). The agreement prefix on the participle is always overt. For the sake of explicitness, I mark deleted agreement prefixes as null morphemes and provide a gloss.

- (4)  $\emptyset$ - $\emptyset$ -be            **ngi-pheka**  
 1sg.s-RPST-AUX 1sg.s-cook.IMPF.PTCP  
 ‘I was cooking (recently)’

Ndebele distinguishes a present, past and a future tense, and additionally makes a remoteness contrast in the past. The so called Recent Past tense is used to describe events that took place earlier that day or a day or two ago. Otherwise, the Distant Past must be used. The table in (5) shows all simple tenses in Ndebele. As we see, the morphological difference between tenses is encoded in the form of the tense prefix and the form of the final suffix. The root used in (5) is *bal* ‘read’, and the verb is inflected for 1st person singular subject agreement.

- (5) Ndebele simple tenses:

Tense	S-AGR	TM	Root	Final Suff	Surface form	translation
Simple Present	ngi	$\emptyset$ / <i>ya</i>	bal	a	ngi( <i>ya</i> )bala	I am reading
Recent Past	ngi	$\emptyset$	bal	<i>e:/ile</i>	ngibale:/ngibalile	I read (recently)
Distant Past	ngi	a	bal	a	ngabala	I read
Simple Future	ngi	za	bal	a	ngizabala	I will read

(5) does not include derivational suffixes or an object agreement prefix – these types of verbal morphology will be largely irrelevant in this thesis. Note that there are two ways to express Simple Present and Recent Past. In Simple Present, the tense prefix can be null or have the form *ya*. In Recent Past, the final suffix can be either *e:* or *ile*. This variation is the so called conjoint–disjoint alternation attested in many Bantu languages. Present forms with *ya* and Recent Past forms with *-ile* are the disjoint alternates (also known as the long forms). In Ndebele, the alternation seems to be regulated the same way as in Zulu: the verb has a disjoint (long) form if it is phrase fina (the identity of the relevant phrase, e.g. if it’s a vP or a TP, is debated) (Van der Spuy, 1993; Buell, 2006; Cheng & Downing, 2012; Halpert, 2012, among others).

Most of the four tenses in (5) can also occur in periphrastic constructions, where tense marking

appears on the auxiliary verb. The only tense that can never appear in a compound construction in the present tense. The main verb in compound tenses has a participial form – in imperfective compound tenses, for example, it is an imperfective participle. In perfect tenses, it is a past participle. The paradigm in (6) includes all three imperfective compound tenses.

(6) Imperfective compound tenses in Ndebele

- |    |                                      |                           |                                  |
|----|--------------------------------------|---------------------------|----------------------------------|
| a. | U-∅-be<br>2sg.s-RPST-AUX             | u-bala<br>2sg.s-read.IMPF | <i>Recent Past Imperfective</i>  |
|    | ‘You were reading (recently)’        |                           |                                  |
| b. | U-a-ye<br>2sg.s-DPST-AUX             | u-bala<br>2sg.s-read.IMPF | <i>Distant Past Imperfective</i> |
|    | ‘You were reading (a long time ago)’ |                           |                                  |
| c. | U-za-be<br>2sg.s-FUT-AUX             | u-bala<br>2sg.s-read.IMPF | <i>Future Imperfective</i>       |
|    | ‘You will be reading (recently)’     |                           |                                  |

Periphrastic constructions like the imperfective tenses in (6) constitute the main empirical domain of this study.

In the next section, I lay out the assumptions about word formation in the verbal domain.

## 2.2 Head movement and word formation

Perhaps the most puzzling piece of verbal morphology in Bantu languages is the Final Suffix. It is the only suffix associated with inflectional morphology, such as tense. Otherwise, inflectional morphology is prefixal, while suffixes include what is referred as a derivational morphology or argument structure changing morphology: applicative, causative, reciprocal and passive suffixes. For this reason, the Final Suffix is often treated as an agreement morpheme, which covaries with a number of inflectional categories: tense, aspect, mood and polarity.

Following this approach, I treat the Final Suffix as the host an inflectional agreement probe – a head with an unvalued Infl-feature. I assume that this feature is located in little *v* and undergoes

agreement with the most local valued inflectional feature. In the Recent Past tense, for example, [Infl:—] on *v* agrees with [Infl:PST] on T, as shown in (7). (I assume a version of Reverse Agree/Upward Agree, where valuation is a transmission of feature values from a higher head to a lower one (Adger, 2003; Zeijlstra, 2012; Bjorkman & Zeijlstra, 2014; Merchant, 2011; Wurmbrand, 2011)).

(7) The Final Suffix arises via Infl-agreement

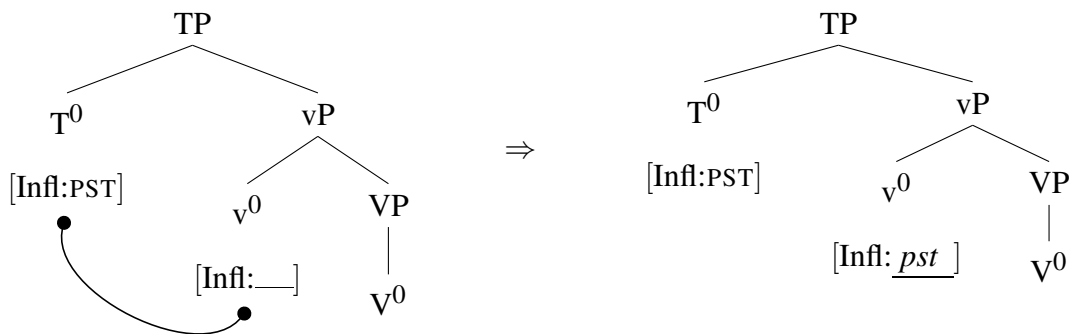

Thus, the Final Suffix is treated here as the exponent of little *v*. The way *v* ends up as a suffix on the verb stem is by head movement of *V* to *v*. It is a matter of ongoing debate how high verbs move in Bantu languages. There seems to be a consensus, however, that verb movement proceeds at least as high as the position of the final suffix. The identity of that head is less clear. It has been proposed, for instance, that it is a low Mood head (Julien, 2002) or an Aux head (Buell, 2005). It is important to note that the Aux head in Buell’s analysis is not a head associated with auxiliary verbs but simply an inflectional head hosting the Final Suffix. I do not adopt these approaches and propose instead that the Final Suffix is an exponent of an agreeing *v* head. The tree in (8) is the structure of a Recent Past sentence after Infl-valuation and head movement of *V* to *v*.

(8) U-∅-bal-ile  
 1s-PST-read-FS.PST  
 ‘She read (recently)’



(10) A derivation of VS order in Ndebele

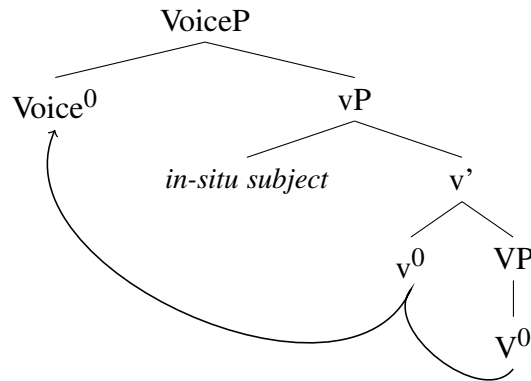

It is difficult to find empirical evidence for head movement of the verb to higher functional heads, e.g. T. Diagnostics based on relative word order with negation and adverbs are not applicable since negation is affixal, and adverbs are linearized to the right, rendering further verb movement string vacuous. For this reason, claims about verb movement Bantu languages are often based on affix order.<sup>2</sup> Adopting the Linear Correspondence Axiom (Kayne, 1994), whereby movement can only result in suffixation, Julien (2002) argues that verb movement proceeds only as high as the Final Suffix. All heads realized by prefixes are not moved to and have the status of freely standing morphemes/particles, concatenated phonologically on the verb stem. This treatment of verb movement in Bantu languages was adopted for example in Buell (2005), Van der Wal (2006) or Muriungi (2009), and I assume it here as well. I should point out, however, that the claims I make about the syntax of multi-verb constructions do not rely on this approach to word formation. They are compatible with the view that head movement can result in both suffixation and prefixation (as suggested for Bantu e.g. by Kinyalolo (1991)).

Thus, I assume that the verb moves only to Voice in Ndebele. In (11), for example, the tense

---

2. Another diagnostic for verb movement that has been used for Bantu languages is ellipsis, in particular Verb-Stranding VP ellipsis (Ngonyani, 1996a,b, 1998; Goldberg, 2005), which has shown that in some Bantu languages the verb moves out of the ellipsis site. There is no convincing evidence that VP/vP ellipsis in Ndebele is possible in the first place. Arguable cases of V-stranding VP ellipsis can be argued to involved object drop instead. Moreover, the main verb cannot be elided in compound tenses, stranding the auxiliary. For more discussion and data on ellipsis, see chapter 5 section 5.4.2.

prefix *za-* is a realization of T, which does not form a complex head with the verb stem in Voice (12).

- (11) U-za-bal-a  
 1s-FUT-read-FS.FUT  
 ‘She will read’

(12) Assumed verb movement in Ndebele

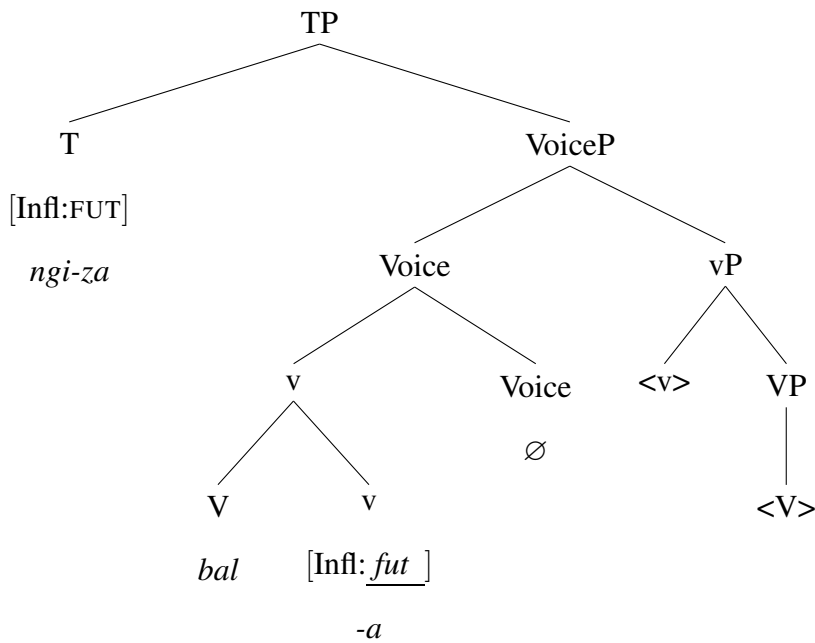

The structure in (12) derives the correct affix order for the example in (11) and for all active verb forms. In the passive, however, Voice has an overt exponent, namely the suffix *-w*. As we see in (13), the passive morpheme *precedes* the Final Suffix.

- (13) Ibhuku li-za-bal-w-a  
 5book 5s-FUT-read-PASS-FS.FUT  
 ‘The book will be read’

The assumed head movement predicts a different affix order: we expect the passive suffix to follow the Final Suffix, as in (14).

(14) Verb movement in Ndebele: passive voice

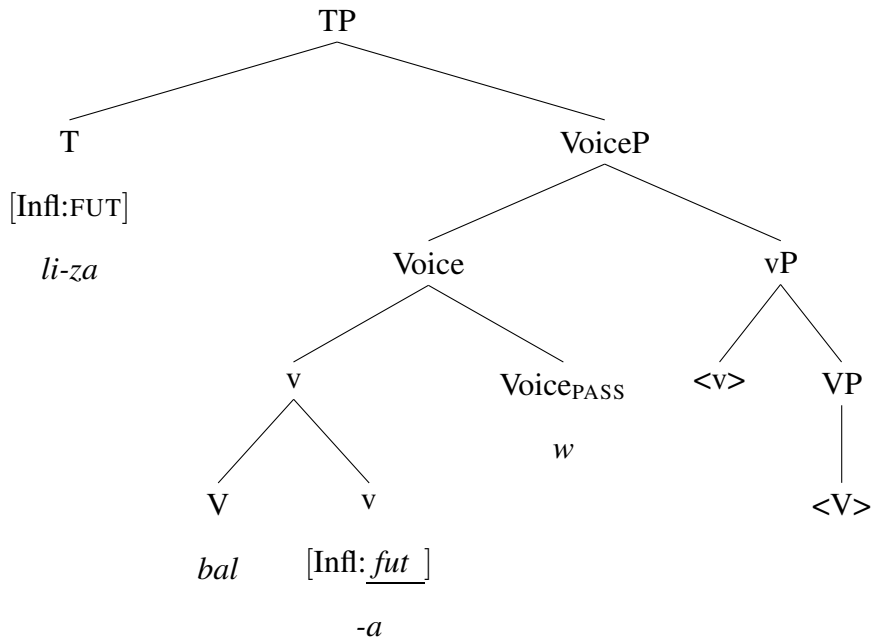

Given that the affix order predicted by (14) is incorrect, the analysis must be amended in some way. One possibility to consider is that the order of functional heads is different; in particular, that Voice is lower than v. This would render the exponent of v the final suffix. This is, however, inconsistent with the standard assumption that Voice is a higher functional category than v. The hypothesis that the order is reversed in Ndebele and related languages would require an independent argument. Alternatively, one might posit an extra functional projection above VoiceP, whose only role is to host the final suffix. Julien's (2002) low Mood head and Buell's (2005) Aux<sup>0</sup> are instances of this type of analysis. The third alternative is to retain the syntax in (14) and assume that the order of v and Voice is subject to a post-syntactic rearrangement. Since the first two alternatives have no independent motivation (their only motivation is to accommodate affix order), I choose to not complicate the syntax of the Ndebele verb and analyze the reverse order of Voice and v as resulting from Local Dislocation (Embick & Noyer, 2001).

Local Dislocation is a post-syntactic displacement operation which applies after linearization and vocabulary insertion. The complex Voice head in (14) is linearized as shown in (15) (where



the notation  $a * b$  means "a precedes b"). As a result of local dislocation,  $v$  is displaced to the right of Voice, to form a complex element with it, as shown in (16).

(15) Linearization of the Voice complex head in (14):  $[[V * v] * \text{Voice}]$

(16) Local dislocation:  $[V * [\text{Voice} + v]]$

Since most data to be used is in the active voice, where Voice has a null exponent, Local Dislocation of  $v$  to the right of Voice will not be of much relevance in the following chapters.

### **2.3 Word order and agreement**

The basic word order in Ndebele is SVO, with the possibility of post-verbal subjects, as discussed in section 2.1. I assume that the SVO order is derived by movement of the subject DP from its base-generated position within  $vP$  to Spec, TP, as shown in (17) (a small modification of this assumption will be introduced chapter 6 section 6.2.1, and it will not be relevant in the discussion preceding chapter 6.) In this position, the subject precedes the verb, which moves to Voice.

(17) The derivation of SVO order

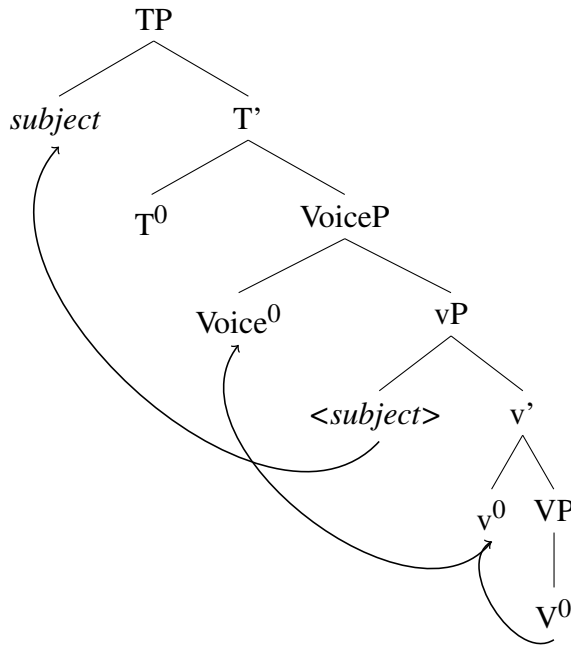

One difference between pre-verbal and post-verbal subjects is in agreement. Preverbal subjects always control agreement of the verb (18-a), while agreement with an in-situ subject is impossible. Instead, the subject agreement prefix is the class 17 prefix *ku-* (18-b).

- (18) a. Abantwana **ba-**za-hlabela  
 2children 2s-FUT-sing  
 ‘The children will sing’
- b. **Ku-**za-hlabela abantwana  
 17s-FUT-sing 2children  
 ‘It’s the children who will sing’

The pattern in (18) illustrates the robust generalization that  $\varphi$ -agreement in Bantu languages cooccurs with movement. Accounts of this generalization include analyses which make  $\varphi$ -agreement on a functional head F dependent on movement of the agreement controller to the specifier of FP (Demuth & Harford, 1999; Buell, 2005; Carstens, 2005; Baker, 2008, a.o.). If the  $\varphi$ -probe in a simple tense is on T, the subject controlling agreement on T must be located in (or have moved

through) Spec,TP. I indeed assume, following the authors above, that T is an agreeing head in simple tenses. In general, I treat  $\varphi$ -probes as properties of functional heads such as T or Asp, rather than as dedicated subject agreement projections (e.g. AgrSP (Buell, 2005) or FinP (Julien, 2002)). I discuss  $\varphi$ -agreement and the location of probes in more detail in chapter 6.

One aspect of subject agreement which will be of importance in chapter 6 is its allomorphy. Subject agreement with DPs of class 1 has three allomorphs: *u-* on the principal form (the highest verb in an indicative clause) (19-a), *e-* on participles (19-b), and *a-* on subjunctive verb forms (19-c).

(19) Class 1 agreement

- |    |   |                         |
|----|---|-------------------------|
| a. | UZodwa <b>u</b> -za-pheka<br>1Zodwa 1s-FUT-cook<br>'Zodwa will cook'                                  | <i>principal form</i>   |
| b. | UZodwa u-za-be <b>e</b> -pheka<br>1Zodwa 1s-FUT-AUX 1s-cook.IMPF.PTCP<br>'Zodwa will be cooking'      | <i>participial form</i> |
| c. | Ngi-funa ukuthi UZodwa <b>a</b> -pheke<br>1sg-want COMP 1Zodwa 1s-cook.SBJV<br>'I want Zodwa to cook' | <i>subjunctive form</i> |

As we will see, subject agreement allomorphy is often the only morphological indicator of principal, participial and subjunctive forms, and therefore I will use class 1 subjects whenever the three forms need to be distinguished.

The next chapter opens the discussion of multi-verb constructions in Ndebele – the main topic of this thesis. Any additional aspects of Ndebele grammar will be introduced as they become relevant for the discussion of multi-verbal syntax in the following chapters.

## CHAPTER 3

### AUXILIARY VERBS AS NON-PROJECTING VERBS

#### 3.1 Introduction

The main goal of this chapter is to confront three existing approaches to auxiliary verbs and argue, on the basis of evidence from Ndebele, that auxiliary verbs should not be treated as elements of the same category as lexical verbs, i.e. verbs projecting a VP.

By *auxiliary verb* we typically mean the verb *be* (or *have*) appearing in compound tenses, such as the English progressive tenses.<sup>1</sup> The hallmark of such constructions is the monoclausality of a multi-verb construction, evident for instance from binding.

(1) John<sub>i</sub> **was** [not-a-clause **lying** to himself<sub>i</sub>. ]

In fact, there seems to be no convincing evidence that auxiliary verbs, such as the English *be* in progressive tenses, contribute even a reduced biclausality. The overall syntax of a compound tense is roughly the same as the syntax of simple tense (or exactly the same, as some have argued). Given this, auxiliary verbs have been treated as deficient compared to regular lexical verbs, even though specific implementations of this idea differ quite a bit. I consider in this chapter three prominent approaches to auxiliary verbs, listed below.

(2) Approaches to auxiliary verbs

- a. **The VP approach** – auxiliaries are verbs projecting a VP
- b. **The FP approach** – auxiliaries spell out functional heads
- c. **The Insertion approach** – auxiliaries are not projected at all, but rather are inserted by some non-conventional means

---

1. Modal verbs are also often treated as auxiliary verbs. However, Ndebele lacks modals of the type found in Germanic languages, for instance, and the discussion of auxiliaries in this thesis is limited to default and aspectual auxiliaries.

The VP approach dates back to Ross (1967, 1969) and has been adopted in much later work, e.g. Huddleston (1974); Emonds (1978); Pollock (1989); Roberts (1998); Déchaine (1993); Déchaine (1995); Schütze (2003); Harwood (2014b), often with some modifications. It states that auxiliary verbs are projected as a separate head and that this head is of the same category as lexical verbs and projects a VP (contra Chomsky’s (1957) Aux hypothesis according to which auxiliaries and modals are of a different category, Aux) (3).<sup>2</sup>

(3) The VP approach

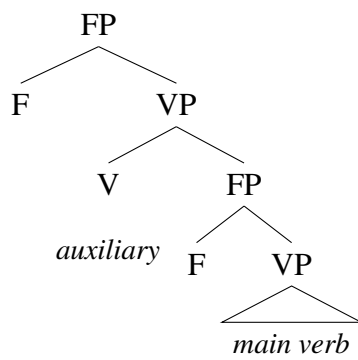

The FP approach was proposed for English auxiliaries in Hoffman (1966); McCawley (1988) and Tenny (1987), and adopted later for auxiliary verbs in general, as well as for some contentful verbs, the so called restructuring verbs (Cinque, 1998, 1999, 2001; Wurmbrand, 2004; Grano, 2012). According to this approach, auxiliary verbs do not have a dedicated position in the clausal structure. Rather, they are associated with functional heads in the main verb’s extended projection, e.g. Asp<sup>0</sup>. Finally, according to the insertion approach, auxiliaries are not associated with any particular head, lexical or functional. Instead, their appearance is the result of some sort of insertion (syntactic or post-syntactic, depending on analysis) in a functional head. This view has been put forth in some form or other by Bach (1967); Embick (2000); Arregi (2000); Cowper (2010);

---

2. It is often assumed that auxiliaries head AuxPs, not VPs. As discussed in section 3.2.3, however, the various implementations of the AuxP analysis are typically a version of the VP approach influenced by the Aux hypothesis: the auxiliary has a dedicated projection, but instead of a VP, its category is AuxP (this has been assumed for Bantu languages as well, e.g. in Henderson (2006) and Baker & Willie (2010)). The discussion of the VP approach in this chapter largely extends to the AuxP implementation. The one way in which the AuxP approach differs from the VP approach concerns the predictions about category projection and I will address this issue in section 3.2.3.

Bjorkman (2011); Arregi & Klecha (2015); Pietraszko (2016). As we see in the schemas below, the two approaches do not assume different syntactic structures, but they disagree as to how the auxiliary verb becomes part of that structure: whether it is base-generated as a functional head (4) or inserted in that head later in the derivation (5).

(4) The FP approach

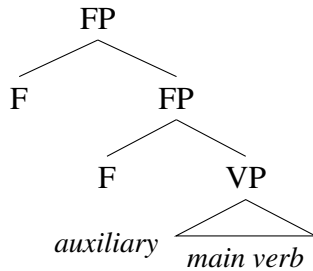

(5) The Insertion approach

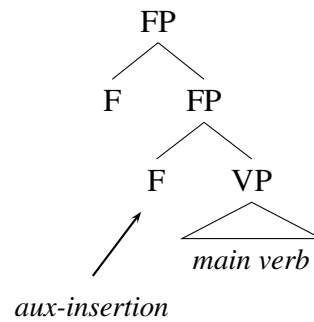

Looking at the schemas above, we see that the FP approach and the Insertion approach form a natural class to the exclusion of the VP approach. The distinguishing property is the amount of structure involved in a periphrastic construction. Under the VP approach, presence of an auxiliary entails increased structural complexity: at the minimum, a compound-tense syntax is larger than a simple-tense syntax by the VP hosting an auxiliary. This is a natural consequence of the hypothesis that auxiliary verbs are true verbs, i.e. Vs that can project a phrasal level. In the other two approaches, the presence of an auxiliary does not entail extra structure. Under the FP approach, the main verb projects its regular extended projection and the auxiliary is a property of one of the functional heads. The lack of extra structure is even more obvious in insertion approaches, which explicitly avoid complicating the syntax to accommodate an auxiliary verb. They assume that the syntax of synthetic and periphrastic expressions is exactly the same, and that the appearance of an auxiliary is triggered by other factors, such as lack of head movement (Arregi, 2000; Embick, 2000) or featural markedness of the inflectional domain (Cowper, 2010; Bjorkman, 2011; Arregi & Klecha, 2015; Pietraszko, 2016). Given these properties of the three approaches, we can classify

them into two groups, depending on whether they assume that auxiliary verbs project (and so add structural complexity) or not. As shown below, the VP approach falls in the first class, while the FP and Insertion approaches are both Non-Projection approaches.

	Projecting Aux	Non-projecting Aux
(6)	the VP Approach	the FP Approach the Insertion Approach

In this chapter, I focus on the classification in (6), and show that auxiliaries in Ndebele are uniformly non-projecting, supporting the non-projection views. I examine two types of auxiliary-verb constructions: aspectual-verb constructions (7) and compound tenses, illustrated in (8).

(7) Aspectual-verb constructions

- |    |  |                           |
|----|--|---------------------------|
| a. | U- <b>lokhe</b> e-bala<br>1s-still 1s-read.IMPF.PTCP<br>'He is still reading'      | <i>lokhe</i> 'still'      |
| b. | U- <b>hlezi</b> e-bala<br>1s-constantly 1s-read.IMPF.PTCP<br>'He constantly reads' | <i>hlezi</i> 'constantly' |
| c. | U- <b>se</b> e-balile<br>1s-already 1s-read.PST.PTCP<br>'He has already read'      | <i>se</i> 'already'       |

(8) Compound tenses

- |    |  |                            |
|----|--|----------------------------|
| a. | U-za- <b>be</b> e-bala<br>1s-FUT-AUX 1s-read.IMPF.PTCP<br>'He will be reading' | <i>Future Imperfective</i> |
| b. | U-∅- <b>be</b> e-bala<br>1s-PST-AUX 1s-read.IMPF.PTCP<br>'He was reading'      | <i>Past Imperfective</i>   |
| c. | U-∅- <b>be</b> e-balile<br>1s-PST-AUX 1s-read.PST.PTCP<br>'He had read'        | <i>Past Perfect</i>        |

Aspectual auxiliaries are verbal elements which express meanings related to aspect and tense and are often encoded by adverbs in other languages. Ndebele has three<sup>3</sup> aspectual auxiliaries: *lokhe* ‘still’, *hlezi* ‘constantly’ and *se* ‘already’. Compound tenses are similar constructions: they also consist of an auxiliary and a participle. The difference is that the auxiliary verb is the *default auxiliary* ‘be’, which does not express the kind of adverbial meanings that aspectual auxiliaries do. In fact, it is difficult to associate it with any specific meaning at all and therefore it has been thought of as semantically deficient or vacuous (Pollock, 1989; Chomsky, 1993; Rothstein, 1999, 2004; Iatridou et al., 2003, among others).

I address three problems that the VP approach faces when applied to Ndebele auxiliaries such as *lokhe* and *be*. The first problem concerns the fact that auxiliary verbs do not project like lexical verbs do (e.g. they never project the argument structure domain<sup>4</sup>). Thus, the theoretical challenge is to accommodate verbs with obligatorily limited projection (in particular, with no projection extending beyond the VP). I call this *the limited-projection problem* and address it in section 3.2. Second, *the selection problem* concerns predictions the VP approach can make about the size and form of the auxiliary’s complement, the main verb. I argue in section 3.3 that viewing auxiliaries as verbs selecting for certain types of participles misses generalizations about the attested patterns of cooccurrence of aspectual auxiliaries and types of participles.<sup>5</sup> I show that these patterns follow naturally if we adopt the FP-approach to aspectual auxiliaries. And third, the VP approach proves inefficient, if not completely inadequate, in accounting for the so-called overflow pattern of aux-

---

3. I have identified a fourth aspectual verb, *hlala*, which means ‘always do/do something for a long time’ and takes an imperfective participle as its complement. However, this verb has a lexical counterpart meaning ‘sit’ or ‘stay’, which can also combine with imperfective participles to mean roughly ‘sit and do something’ or ‘stay doing something’. Due to the similarity in meaning between the two constructions and the fact that speakers are often inconsistent in being able to tell the difference between the two meanings, I do not use this verb in tests meant to diagnose differences between lexical and auxiliary verbs. The other three verbs do not have lexical counterparts in present day Ndebele and therefore are more reliable examples of aspectual verbs.

4. There are lexical verbs which don’t project an arguments structure (unaccusatives verbs). What’s crucial here is that, unlike lexical verbs, auxiliaries are invariably raising. Thus, the issue is their *systematic* non-projection, which I discuss in section 3.2.

5. The selection problem does not arise with default auxiliaries as they are not restricted in this way. They may combine with any type of participle, giving rise to a different type of compound tense; see section 3.3.1.



iliary use, as discussed at length in Bjorkman (2011). I demonstrate in section 3.4 that Ndebele compound tenses are an instance of this pattern of auxiliary use and therefore the auxiliary *be* used in these constructions cannot be analyzed as a base generated verb, contra the VP approach. I conclude that neither aspectual auxiliaries nor the default auxiliary *be* in Ndebele show properties that would support the VP view of auxiliary verbs. Their behavior is better captured by non-projection approaches, where the auxiliary verb is *part of another's verb extended projection*. I take this general characteristic to be the defining property of auxiliary verbs, as indicated by the working definition in (9).

- (9) **Auxiliary verb:** a verbal element which does not have an extended projection of its own, but rather occupies some position in another verb's extended projection.

Aspectual auxiliaries do differ from default auxiliaries: only default auxiliaries show an overflow distribution. As argued by Bjorkman (2011), such a distribution is problematic for the VP and the FP approach and supports a view of periphrasis in which auxiliary verbs are the result of last-resort insertion. A detailed analysis of compound tenses is developed in Chapter 4, where, building on previous accounts of last-resort periphrasis, I propose and argue for an alternative implementation. In this chapter, I focus only on what the two types of auxiliary verbs have in common, namely the non-projection property. Finally, in section 3.5, I provide an explicit formalization of the non-projecting nature of auxiliaries. I adopt Adger's (2010) framework for defining functional categories, in which categories are paired with a number indicating the category's position in the extended projection, what I call its *level*. In the verbal extended projection, the main verb is always of level 1, i.e. the first element in the hierarchy. This is encoded as part of the verb's category feature, as shown in (10). I propose that auxiliary verbs differ from projecting verbs in level specification, as shown in (11)-(12) below.

- (10) Lexical verb:                      (11) Default auxiliary:                      (12) Aspectual auxiliary:
- $\left[ \text{CAT: } \langle \text{V}, 1 \rangle \right]$                      
 $\left[ \text{CAT: } \langle \text{V}, 0 \rangle \right]$                      
 $\left[ \text{CAT: } \langle \text{V}, n > 1 \rangle \right]$

Default auxiliaries have a zero level specification which means they cannot project and are only used as verbal expletives (this nature of default auxiliaries will be discussed in the next chapter). Aspectual auxiliaries, on the other hand, are verbs of a higher level, e.g. 3 (the level of Asp) or 4 (the level of Perf). In this sense they are verbal elements associated with particular inflectional categories, that is *functional verbs*.

### 3.2 The limited-projection problem

A widely adopted hypothesis about clausal syntax is that it consists of a sequence of strictly ordered functional projections which themselves constitute a projection of the main verb. I call it the Extended Projection Hypothesis (13).

- (13) *The Extended Projection Hypothesis*

clausal functional structure is a property of the verbal category, namely its extended projection.

The functional structure making up the clausal spine has been referred to by different names: Functional Hierarchy (Cinque, 1999), Extended Projection (Grimshaw, 2000) or Hierarchy of Projections (Adger & Svenonius, 2011). To illustrate, (14) is (a fragment of) such a hierarchy.

- (14)  $\left[ \text{TP} \left[ \text{PerfP} \left[ \text{AspP} \left[ \text{VoiceP} \left[ \text{vP} \left[ \text{VP} \right] \right] \right] \right] \right] \right]$

According to the Extended Projection Hypothesis, verbs have the property of projecting clausal structure. For this reason, I use the term *projecting verb* to refer to any lexical verb with that property (15).

- (15) **Projecting verb:** an element of the verbal category which can have a full extended projection.

Under the VP approach, auxiliary verbs are of the same category as lexical verbs, namely V. They also head VPs. Thus, the structure of a compound tense under the VP approach would be as in (16), and of an aspectual verb construction as in (17).

- (16) Compound tense (VP approach) (8)

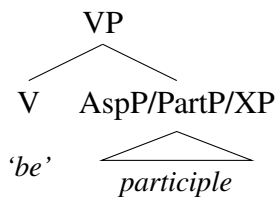

- (17) Aspectual-verb construction (VP approach) (7)

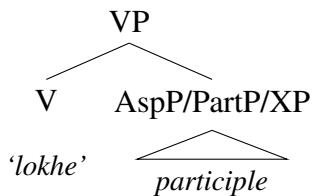

The question now arising is whether auxiliaries such as *be* and *lokhe* share another property of verbs: in particular, the ability to have an extended projection. Below, I present evidence from Ndebele auxiliaries showing they cannot project any functional structure of their own.

### 3.2.1 *The lack of argument structure domain*

A standard assumption about verbal functional structure is that the lower functional domain of a verb's extended projection is the argument structure domain. Thus, if auxiliaries have any extended projection at all, the head projected first are expected to be heads introducing arguments. How-

ever, auxiliary verbs typically lack thematic properties (as argued by Pollock (1989) for English and French, and supported later by crosslinguistic evidence, also from Bantu languages (Carstens & Kinyalolo, 1989; Kinyalolo, 1991; Demuth & Gruber, 1995). In Ndebele too, neither default auxiliaries nor aspectual verbs can be shown to have independent argument structure. Below I review three pieces of evidence that Ndebele auxiliaries are raising verbs.

*i) Active–passive synonymy.* A common diagnostic for raising is based on active–passive synonymy. Since the surface subject of a raising verb is derived, passivization of the complement verb does not affect truth-conditional meaning (18).

- (18) a. John seems to have made a decision.  $\approx$   
 b. The decision seems to have been made (by John).

Both default auxiliaries and aspectual auxiliaries behave like raising verbs in this respect. As shown below, passivization of the main verb does not affect the truth conditions in either compound tenses (14) or aspectual-verb constructions (15).

(19) Compound tense (raising across a default auxiliary)

- a. UZodwa u-za-be e-pheka inyama.  
 1Zodwa 1s-FUT-AUX 1s-cook 5meat  
 Zodwa will be cooking meat.
- b.  $\approx$  Inyama i-za-be i-phek-w-a ng-uZodwa.  
 9meat 9s-FUT-AUX 9s-cook-PASS-FS by-1Zodwa  
 The meat will be cooked by Zodwa.

(20) Aspectual-verb constructions (raising across an aspectual auxiliary)

- a. UZodwa u-lokhe e-pheka inyama. *lokhe* ‘still’  
 1Zodwa 1s-still 1s-cook.IMPF 5meat  
 Zodwa is still cooking meat.
- b.  $\approx$  Inyama i-lokhe i-phek-w-a ng-uZodwa.  
 9meat 9s-still 9s-cook-PASS-FS by-1Zodwa  
 The meat is still being cooked by Zodwa.

- b. UZodwa u-hlezi e-pheka inyama.  
 1Zodwa 1s-constantly 1s-cook.IMPF 5meat  
 Zodwa constantly cooks meat.
- d.≈ Inyama i-hlezi i-phek-w-a ng-uZodwa.  
 9meat 9s-constantly 9s-cook-PASS-FS by-1Zodwa  
 The meat is constantly cooked by Zodwa.
- c. UZodwa u-se e-phek-e: inyama.  
 1Zodwa 1s-already 1s-cook-FS.PST 9meat  
 Zodwa has already cooked the meat.
- f.≈ Inyama i-se i-phek-w-e: ng-uZodwa.  
 9meat 9s-already 9s-cook-PASS-PST.FS by-1Zodwa  
 The meat has already been cooked by Zodwa.

In contrast, control verbs, such as *try* or *want*, do have thematic subjects and therefore no such synonymy obtains, as shown in (21) and (22).

- (21) a. UZodwa u-zama uku-pheka inyama.  
 1Zodwa 1s-try INF-cook 5meat  
 Zodwa is trying to cook meat.
- b. #Inyama i-zama uku-phek-w-a ng-uZodwa.  
 9meat 9s-try INF-cook-PASS-FS by-1Zodwa  
 # The meat is trying to be cooked by Zodwa.
- (22) a. UZodwa u-funa uku-pheka inyama.  
 1Zodwa 1s-want INF-cook 5meat  
 Zodwa wants to cook meat.
- b. #Inyama i-funa uku-phek-w-a ng-uZodwa.  
 9meat 9s-want INF-cook-PASS-FS by-1Zodwa  
 # The meat wants to be cooked by Zodwa.

Thus, there is no evidence from argument structure that auxiliaries in Ndebele, default or aspectual, project an argument structure domain. While the lack of an external argument is not necessarily indicative of a limited projection (unaccusative verbs, for instance, have an extended projection but no external arguments), non-projection approaches derive the systematic raising status of auxiliary verbs.

Under the FP approach, an auxiliary is not of the same category as main verbs, but rather they are associated with a functional category, which has a fixed position in the extended projection.<sup>6</sup> I argue that this is true for aspectual auxiliaries in Ndebele, which express meanings of aspectual/temporal adverbs: ‘still’, ‘constantly’ and ‘already/now’ (for a similar analysis of aspectual auxiliaries in Kilega, see Carstens (2005)). Following Cinque (1998, 1999), I assume that such meanings are associated with specific functional projections in the clausal spine. According to Cinque, adverbs expressing such meanings are specifiers of the relevant FP, while if the meanings are encoded by verbs, we have to do with functional verbs spelling out the relevant F<sup>0</sup>. As mentioned before, Ndebele has only three reliable instances of aspectual auxiliaries: *lokhe* ‘still do’, *hlezi* ‘constantly do’ and *se* ‘already do’.<sup>7</sup> Cinque’s hierarchy is very fine-grained, consisting of thirty functional projections, each associated with a different type of temporal/aspectual/modal (TAM) meaning. Given the lack of a wide array of aspectual verbs in Ndebele, it is difficult to reconstruct the entire hierarchy for this language. Instead, I will assume a simplified version of the functional hierarchy – one which is necessary to accommodate the three aspectual auxiliaries we find. As shown in (23), the auxiliary *se* ‘already’ is associated with Perf<sup>0</sup> (in Cinque’s hierarchy: T(Anterior)), while the verbs *lokhe* ‘still’ and *hlezi* ‘constantly’ are associated with an imperfective Asp head.<sup>8</sup>

(23) [ T<sup>0</sup> [ Perf<sup>0</sup> *se* ‘already’ [ Asp<sup>0</sup><sub>IMPF</sub> *lokhe* ‘still’ / *hlezi* ‘constantly’ [ Voice<sup>0</sup> ... ]]]]

Given that is the structure (23) is articulated enough to accommodate Ndebele aspectual aux-

---

6. In section 3.5, I present a more explicit implementation of the FP approach. Auxiliaries in the proposed FP approach are identical neither to the functional heads they are associated with nor to lexical verbs. Their category feature is a particular combination of the category of projecting verbs and the category of a functional head.

7. The meaning of *se* is somewhat flexible: depending of its temporal and aspectual context, it may also mean ‘now’ or ‘then’.

8. It is possible that *lokhe* and *hlezi* are in fact two different types of the Asp head, e.g. Asp<sub>CONTINUATIVE</sub> and Asp<sub>PROGRESSIVE</sub>, respectively. In the absence of a large set of aspectual verbs, it is difficult to make this fine-grained choice. This choice would be, however, immaterial for our purposes and it suffices to treat them both as (types of) imperfective aspect. I return to this issue briefly in section 3.3.3.

iliaries, the arguments and claims I make here do not rely on the exact make up of the functional hierarchy hypothesized by Cinque. What will be important for our purposes is the relative ordering of the head associated with Perfect aspect (Perf or  $T_{(Anterior)}$ ) and the head(s) associated with viewpoint aspect (Asp). One might be skeptical about a universally fixed ordering of thirty projections, but the relative ordering of these two categories is well supported crosslinguistically: both morphosyntactic and semantic evidence points to the conclusion that Perfect aspect is a higher inflectional category than viewpoint aspect (Iatridou et al., 2003; Pancheva, 2003; Bošković, 2014; Harwood, 2013, 2014a; Ramchand & Svenonius, 2014; Aelbrecht & Harwood, 2015) and that it is more related to tense than to viewpoint aspect (Hoffman, 1966; Bach, 1967; McCawley, 1971, 1988; Klein, 1994; Stowell, 2007; Arregi & Klecha, 2015). This ordering of functional heads is referred to as the *Perfect-over-Progressive* generalization in Ramchand & Svenonius (2014), but I will use the more accurate name *Perfect-over-Asp* (the use of *Progressive* was due to the fact that, in English, the only morphosyntactically marked type of aspect is the progressive).

Going back to the limited projection problem, the FP approach to aspectual auxiliaries in (23) predicts their raising nature. For instance, an aspectual verb in Asp is in a particular position in the extended projection and, assuming that the hierarchy is fixed, it can only project categories that can appear above Asp according to the hierarchy of projections. These categories include Perf and T, but not argument-introducing heads such as v or Voice. Therefore, surface subjects of aspectual auxiliaries cannot be their thematic subjects and must instead be derived.

This analysis can be extended to default auxiliaries, appearing in compound tenses. If the auxiliary is associated with a functional head, rather than being a verb projecting a VP, we predict that it cannot have a thematic subject. Note that the choice between the FP approach and insertion approach renders the same result in this respect. Under the the insertion approach, auxiliaries are also associated with a functional head. The difference is in the mode of association (base-generation vs insertion), which is irrelevant for this argument. In fact, I will adopt the insertion approach for default auxiliaries in chapter 4.

ii) *Idiom chunks*. Another piece of evidence the auxiliaries have no thematic subjects comes from the fact that their subjects be a part of an idiom. In the sentence in (24), for example, the subject *iqaqa* ‘skunk’ is part of the idiomatic meaning.

- (24) Iqaqa a-li-zizwa ukunuka  
 5skunk neg-5s-smell 15stink  
 Idiomatic: ‘People don’t see their own faults’  
 Literal: ‘A skunk doesn’t smell its own stink’

The subject of (24) cannot appear as a subject of control verbs and retain its idiomatic interpretation – the sentence in (25) has only have the literal meaning.

- (25) Iqaqa li-zama uku-nga-zizwa ukunuka. \*Idiom  
 5skunk 5s-try INF-NEG-smell 15stink  
 ‘The skunk is trying to not smell its own stink’

With auxiliaries, both default and aspectual, the idiomatic meaning is available (26)-(27).

- (26) Default auxiliary
- Iqaqa li-za-be li-nga-zizwa ukunuga. ✓ Idiom  
 5skunk 5s-FUT-AUX 5s-NEG-smell 15stink  
 ‘People will not see their faults’
- (27) Aspectual auxiliaries
- a. Iqaqa li-lokhe li-nga-zizwa ukunuga. ✓ Idiom  
 5skunk 5s-still 5s-NEG-smell 15stink  
 ‘People still don’t see their faults’
- b. Iqaqa ∅-se li-zizwa ukunuka. ✓ Idiom  
 5skunk 5s-now 5s-smell 15stink  
 ‘People are now starting to see their faults’
- c. Iqaqa li-hlezi li-nga-zizwa ukunuka. ✓ Idiom  
 5skunk 5s-constantly 5s-NEG-smell 15stink  
 ‘People constantly don’t see their faults’



The idiomatic reading can only be available in these constructions if the surface subject is derived. Thus, the idiom test provides additional evidence that default and aspectual auxiliaries in Ndebele do not project thematic subjects.

*iii) Position of in-situ subjects.* Finally, word order in Ndebele can be used as a diagnostic for raising. As discussed in chapter 2, in-situ subjects in Ndebele are linearized to the immediate right of the verb (any other vP-internal and external material follows the postverbal subject). Recall also that unlike preverbal subjects (28-a), in-situ subjects do not control agreement on the verb, which surfaces with the default agreement prefix *ku* (28-b). (The two sentences in (28) additionally differ in the shape of the final suffix, *-e:* vs *-ile*, which reflects the conjoint/disjoint alternation).

- (28) a. UZodwa u-phek-ile.  
 1Zodwa 1s-cook-FS.PST  
 ‘Zodwa cooked.’
- b. Ku-phek-e: uZodwa.  
 17s-cook-FS.PST 1Zodwa  
 ‘It’s Zodwa who cooked.’

By assumption, the VS order is derived by verb movement to Voice<sup>0</sup>, a head immediately above vP and leaving the subject in its base-generation position s, Spec,vP (29).

(29) The derivation of VS order in Ndebele

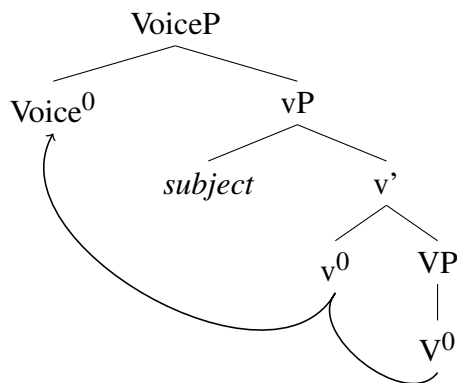

Since right-dislocation is string vacuous and left-dislocation is peripheral, nothing can linearly

intervene between an in-situ subject and its verbal predicate.

Given this, the VS order can help us diagnose whether a verb has a thematic subject. The logic of the diagnostic is the following: if a DP is a thematic subject<sup>9</sup> of a verb V, the DP can appear immediately to the right of V, when in its in-situ position. Conversely, if a DP cannot appear immediately to the right of V, it is not the V's thematic subject.<sup>10</sup>

In multi-verb constructions, the linear position of an in-situ subject can help us determine which verb projects a thematic subject and which verb does not. If a DP is a thematic subject of one of the verbs, it will immediately follow that verb when left in-situ. If the DP cannot immediately follow a verb, it is not its thematic subject. As we see below, neither type of auxiliary verb can be immediately followed by the subject DP, which would then intervene between the auxiliary and the participle. (Note that this fact is not related to agreement: (30-b), for example, is ungrammatical whether the participle agrees with the intervening subject or not.) Instead, the in-situ position is linearized to the right of the main, lexical verb.

---

9. By "thematic subject" I mean a thematic argument (external or internal) which ends up being the surface subject of the verb.

10. This diagnostic cannot involve a stronger statement, namely that an immediately post-verbal subject must be the verb's thematic subject. This is due to the distribution of hyperraising in Ndebele, which allows raising to (apparent) in-situ positions. Consider the raising modal verb *fanele* 'must', which selects a CP. As we see in (i)-a and (i)-b, raising is optional. Crucially, however, the matrix preverbal position is not the only possible raising site: the embedded subject may move to the matrix *post*-verbal position (i)-c.

- (i) a. **UZodwa** u-fanele [<sub>CP</sub> ukuthi a-pheke. ]  
 1Zodwa 1s-must COMP 1s-cook.SBJV  
 'Zodwa must cook'
- b. Ku-fanele [<sub>CP</sub> ukuthi **uZodwa** a-pheke. ]  
 17s-must COMP 1Zodwa 1s-cook.SBJV  
 'Zodwa must cook'
- c. Ku-fanele **uZodwa** [<sub>CP</sub> ukuthi a-pheke. ]  
 17s-must 1Zodwa COMP 1s-cook.SBJV  
 'Zodwa must cook'

Given the possibility of post-verbal subjects which are not thematic subjects of the verbs they immediately follow, the word order diagnostic cannot be stated as a bi-directional implication. It still holds, however, that a thematic subject must be able to occur in the immediately post-verbal positions, which means that if a DP cannot appear in that position, it is not a thematic subject of the verb in question.

(30) In-situ subject in compound tenses: no medial position

- a. **UZodwa** u-za-be e-pheka.  
1Zodwa 1s-FUT-AUX 1s-cook  
'Zodwa will be cooking'
- b. \*Ku-za-be **uZodwa** ku-pheka/e-pheka .  
17s-FUT-AUX 1Zodwa 17s-cook/1s-cook  
(‘It’s Zodwa who will be cooking’)
- c. Ku-za-be ku-pheka **uZodwa**.  
17s-FUT-AUX 17s-cook 1Zodwa  
'It’s Zodwa who will be cooking'

(31) In-situ subject in Asp-V constructions: no medial position

- a. Ku- lokhe ku- bala **uZodwa**. *lokhe* ‘still’  
17s- still 17s- read 1Zodwa  
'It’s Zodwa who is still reading'
- b. \*Ku- lokhe **uZodwa** ku/e- bala.  
17s- still 1Zodwa 17s/1s- read  
(‘It’s Zodwa who is still reading’)
- c. Ku- hlezi ku- bala **uZodwa**. *hlezi* ‘constantly’  
17s- constantly 17- read 1Zodwa  
'It’s Zodwa who constantly reads?'
- d. \*Ku- hlezi **uZodwa** ku/e- bala?  
17s- constantly 1Zodwa 17s/1s- read  
(‘Who constantly reads?’)
- e. ∅- se ku- bal-e: **uZodwa**. *se* ‘already’  
17s- already 17- read-FS.PST 1Zodwa  
'It’s Zodwa who’s already read'
- f. \*∅- se **uZodwa** ku/e- bal-ile.  
17s- already 1Zodwa 17s/1s- read-FS.PST  
(‘It’s Zodwa who’s already read’)

Non-projecting approaches to auxiliary verbs predict the unavailability of a medial subject position in both compound tenses and aspectual-verb constructions. If auxiliary verbs are in some way associated with a functional head, such as Asp or Perf, they are not predicted to participate

in VS-order derivation like lexical verbs. The tree in (32) is an example structure for both a compound tense and an aspectual-verb construction. As in simple tenses, VS order is derived by verb movement to Voice, rendering the in-situ subject position lower than the derived position of both the main and the auxiliary verb. In effect, there are only two positions available for the subject: to the left of both verbs or to the right of both verbs.

(32) Auxiliary verb constructions: no medial subject position

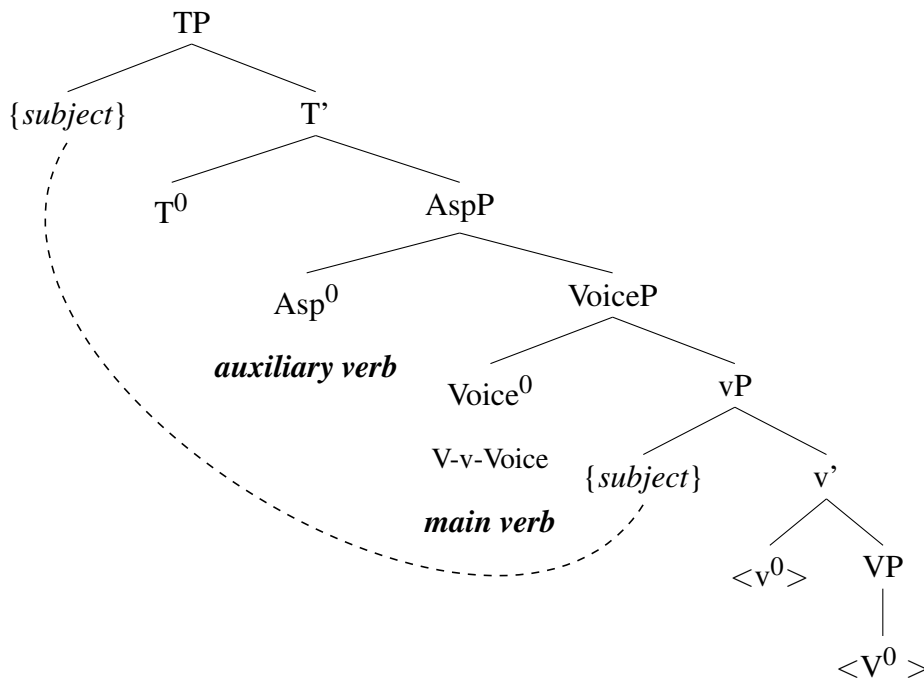

In contrast, the medial position is available in control constructions, involving verbs such as *zama* ‘try’, which have their own external argument and select an infinitive (33-a). As we see in (33-b), the subject may surface immediately to the right of *try*, preceding the infinitive. This word order is naturally predicted by any analysis which assumes that the DP *Zodwa* is a thematic subject of *try*, and the infinitive is its object.<sup>11</sup> (34) shows the two positions available for the subject in (33).

11. Somewhat surprisingly, control/restructuring constructions like (33) optionally allow the overt subject to surface after the infinitive:

- (33) a. **UZodwa** u-zam-e: uku-suka.  
 1Zodwa 1s-try-FS.PST INF-leave  
 'Zodwa tried to leave'
- b. Ku-zam-e: **uZodwa** uku-suka.  
 17s-try-FS.PST 1Zodwa INF-leave  
 'It's Zodwa who tried to leave'

(34) VS order in control clusters:

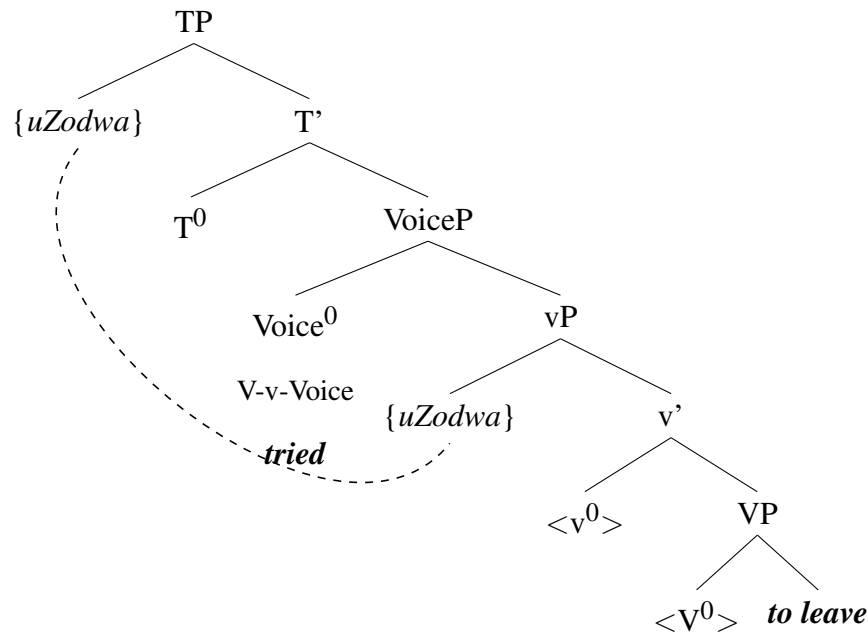

We've seen that control clusters allow a medial position subject, while auxiliary-verb constructions do not. This asymmetry is expected under the assumption that control verbs like *try* have a thematic subject, while auxiliaries do not. Again, since the VP approach treats auxiliaries as verbs projecting a VP, it has nothing to say about why argument-introducing heads such as *v* or *Voice*

- 
- (i) Ku-zam-e: uku-suka uZodwa.  
 17s-try-FS.PST inf-leave 1Zodwa  
 'It's Zodwa who tried to leave'

Discourse properties of the order in (i) are the same as those in (33-b) – the subject is naturally interpreted as being in focus. What makes (i) interesting is that the final position of the subject seems to be an in-situ position as well. This is because movement of a subject DP always co-occurs with agreement. In this case, however, the matrix verb bears default agreement, which suggests that the sentence final position of the subject was not derived by movement from the matrix in-situ position. Instead, (i) appears to be a case of optional backwards control. I leave this issue for future work.

cannot be further projected. On the other hand, the lack of argument structure domain above an auxiliary is predicted by both the FP and the insertion approach.

### 3.2.2 *No regular negation marking*

An additional piece of evidence that auxiliary verbs cannot project the same functional structure as other verbs is the position negation. An interesting property of negation marking in Ndebele (and in many related languages) is that it can appear in two positions within a verb: preceding the subject agreement prefix or following it. The high negation marker *a-* is found in any simple indicative clause, e.g. (35-a). The low negation marker *nga-* is used in reduced clausal constituents, e.g. in infinitives (which in Ndebele are verb nominalizations of class 15) (35-b).

- (35) a. **A-ka-bali.**  
      **neg-1s-read**  
      ‘He doesn’t read’
- b. **uku-nga-bali.**  
      **15-neg-read**  
      ‘to not read/not reading’

Building on previous work on Zulu (Buell, 2005), I assumed in earlier work (Pietraszko, 2017a) that there are two functional projections in the Ndebele clausal spine associated with negation: a left peripheral polarity phrase  $\Sigma$ P and a low NegP, projected immediately above vP/VoiceP. I proposed that negation is a clitic generated in Spec,NegP which undergoes phrasal movement to Spec, $\Sigma$ P, as shown in (36) below.

(36) Negation in simple tenses: movement of Neg-Cl to  $\Sigma$ P (35-a)

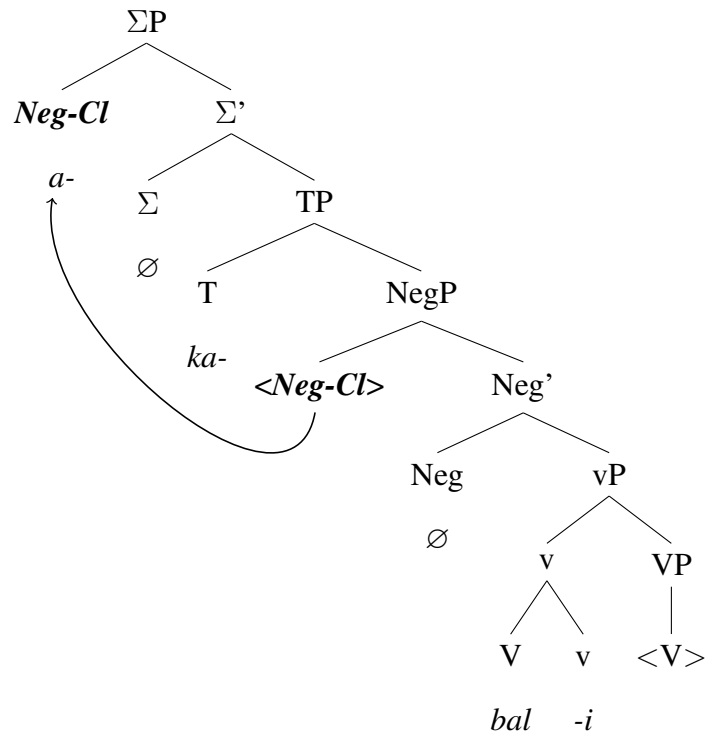

After movement, the negation clitic ends up in a position higher than the subject agreement prefix (by assumption, located in T). Reduced clauses, such as infinitives, lack a complete left periphery including  $\Sigma$ P. In the absence of a movement trigger, the negation clitic stays in situ and appears to the right of the subject agreement prefix. In addition to its low position, the negation clitic has a different form in infinitives: *nga-* instead of *a-*. I treat this formal variation as contextual allomorphy: the negation clitic has the form *a-* when it appears in the context of  $\Sigma$ , and *nga-* otherwise (37).

- (37) a. /a/ ↔ Neg-Cl / \_\_\_  $\Sigma$   
 b. /nga/ ↔ Neg-Cl

Interestingly, auxiliary verbs cannot be prefixed with either high or low negation marker. This is shown for a default auxiliary in (38). The only way to negate that sentence is to negate the lexical verb with the low negation prefix (38-c).

(38) Negation in compound tenses

- a. \***A**-ka-be e-bal-a. \*High NEG on auxiliary  
NEG-1s-AUX 1s-read-IMPF  
(‘He wasn’t reading’)
- b. \***U-nga**-be e-bal-a. \*Low NEG on auxiliary  
1s-NEG-AUX 1s-read-IMPF  
(‘He wasn’t reading’)
- c. U-be **e-nga**-bal-i. Low NEG on main verb ✓  
1s-AUX 1s-NEG-read-IMPF.NEG  
(‘He wasn’t reading’)

I propose that the impossibility of high negation in the auxiliary is due to an additional phasal boundary in a compound tense, one which is absent in simple tenses. In particular, I propose that elements with a verbal category feature introduce a phase boundary to the projection they are associated with.<sup>12</sup> Even though auxiliary verbs are different than lexical, projecting verbs, I argue that they do have a V-feature (for details, see section 3.5). Thus, an auxiliary verb merged in a projection intervening between NegP and  $\Sigma$ P, blocks movement of the Neg-clitic from Spec,NegP to Spec, $\Sigma$ P. In effect, negation is trapped in the low position, attaches to the lexical verb and is pronounced as *nga*. In the structure below, I assume that the auxiliary *be* is located in T (this will be made explicit in chapter 4).

---

12. This is an amendment of my earlier proposal (Pietraszko, 2017a), where I assumed, following (Alboiu & Avery, 2009), that the additional phase boundary is introduced by an aspectual head rather than by the verbal feature of the auxiliary.



(39) Negation in compound tenses: no movement of Neg-Cl across an auxiliary verb

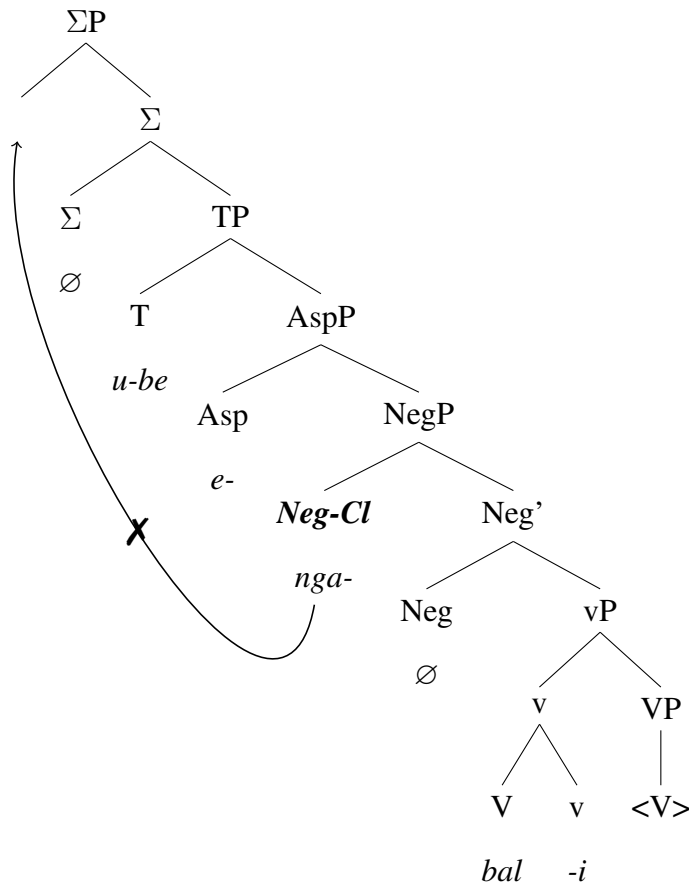

Note that the impossibility of *low* negation is predicted by this account as well since it assumes that the auxiliary is associated with a high inflectional head (here T). Since NegP is lower in the extended projection than T, an auxiliary is correctly predicted to never host low negation. Again, no such prediction follows from the VP approach, which would need to stipulate that some VPs cannot project a NegP.

As shown in (40)-(42), aspectual auxiliaries behave the same way as default auxiliaries: they cannot combine with either a high or a low negation prefix. Instead, negation must be expressed on the lexical verb, as in the case of *lokhe* (40-c) and *hlezi* (41-c), or is impossible altogether, as with the aspectual auxiliary *se* (42-c).<sup>13</sup>

13. It is not clear to me at this point why the auxiliary *se* cannot appear in a negative sentence. It is likely a semantic,

- (40) *lokhe* ‘still’
- a. \***A**-ka-lokhe e-bal-a. \*High NEG on auxiliary  
 NEG-1s-still 1s-read-IMPF  
 (‘He is still not reading’)
- b. \***U-nga**-lokhe e-bal-a. \*Low NEG on auxiliary  
 1s-NEG-still 1s-read-IMPF  
 (‘He is still not reading’)
- c. U-lokhe e-**nga**-bal-i. Low NEG on main verb ✓  
 1s-still 1s-NEG-read-IMPF.NEG  
 ‘He is still not reading’
- (41) *hlezi* ‘constantly’
- a. \***A**-ka-hlezi e-bal-a. \*High NEG on auxiliary  
 NEG-1s-constantly 1s-read-IMPF  
 (‘He doesn’t constantly read’)
- b. \***U-nga**-hlezi e-bal-a. \*Low NEG on auxiliary  
 1s-NEG-constantly 1s-read-IMPF  
 (‘He doesn’t constantly read’)
- c. U-hlezi e-**nga**-bal-i. Low NEG on main verb ✓  
 1s-constantly 1s-NEG-read-IMPF.NEG  
 ‘He constantly doesn’t read’
- (42) *se* ‘already/now’
- a. \***A**-ka-se e-bal-ile. \*High NEG on auxiliary  
 NEG-1s-already 1s-read-PST  
 (‘He hasn’t already/yet read’)
- b. \***U-nga**-se e-bal-ile. \*Low NEG on auxiliary  
 1s-NEG-already 1s-read-PST  
 (‘He hasn’t already/yet read’)
- c. \***U**-se e-**nga**-bal-anga. \*Low NEG on main verb  
 1s-always 1s-NEG-read-PST.NEG  
 (‘He hasn’t already/yet read’)

Assuming the current proposal, according to which aspectual auxiliaries are verbal elements hosted

---

not a syntactic, issue given that other aspectual auxiliaries are not constrained in this way.

in functional aspectual head (Perf<sup>0</sup> and Asp<sup>0</sup>), the distribution of negation is accounted for by the same mechanism as in compound tenses: movement to  $\Sigma$ P is blocked by aspectual auxiliaries because they have a V-feature which introduces a phasal boundary at the projection they are associated with. Since both Perf<sup>0</sup> and Asp<sup>0</sup> intervene between NegP and  $\Sigma$ P, Neg-clitic movement is impossible and the neg-clitic must surface low.

We've seen some evidence that the structure projected above auxiliary verbs in Ndebele is systematically deficient compared to lexical verbs: neither default nor aspectual auxiliaries have an extended projection that would support argument structure or negation marking. These facts are better captured by non-projection approaches. Unlike the VP approach, they *predict*, not stipulate, the limited projection effects with auxiliaries.

### 3.2.3 *Non-projecting verbs: a theoretical challenge*

Confronting auxiliaries' systematic inability to project their own extended projection with the Extended Projection Hypothesis posits a theoretical challenge. The Extended Projection Hypothesis yields two implications: i) the presence of clausal structure entails the presence of a verbal category inside that structure and ii) any verbal category can, in principle, project clausal structure. Both of these implications seem to hold. Possible counterexamples to the first implication would be e.g. clauses with non-verbal predicates. It is, however, not obvious that clausal syntax with non-verbal predicates lacks an element of a verbal category – many languages require a verbal copula in non-verbal predication. On the other hand, languages (or constructions) without a verbal copula (e.g. with zero or pronominal copulas) are inflectionally deficient in precisely the way in which a clause without the projections in (43) would be.

(43) [TP [PerfP [AspP [VoiceP [vP [VP ]]]]]]

An instance of such deficiency is the distribution of copulas in Arabic. Arabic has two types of copulas: pronominal and verbal (Eid, 1983). As we see from the paradigm in (44), a pronom-

inal copula can optionally be used, but *only* in the present tense (which has been argued to be syntactically inert in many varieties of Arabic (Benmamoun, 2000)). In order to encode temporal information such as past or future tense, a verbal copula must be used.

- (44) a. Il-mudarris (**huwwa**) il-latiif.  
 the-teacher PRON the-nice  
 ‘The teacher is nice/ the nice one.’
- b. Il-mudarris **kaan** latiif.  
 the-teacher was nice  
 ‘The teacher was nice.’
- c. Il-mudarris **haykuun** latiif.  
 the-teacher will.be nice  
 ‘The teacher will be nice.’

Importantly, the Extended Projection Hypothesis helps us understand paradigms such as (44) since it entails a tight connection between the presence of inflectional categories such as tense and aspect and the presence of a verb.

The second implication, that every verb can project an extended projection, could be countered by the existence of restructuring infinitives. It has been argued that some control constructions involve radical structure reduction: to bare VP. For instance, the complement of the German verb *versuchen* ‘try’ in (45) is a VP (Wurmbrand, 2001).

- (45) ... weil Hans [VP [VP den Traktor zu reparieren ] versuchte ] (Wurmbrand, 2001:17)  
 since John the tractor.ACC to repair tried  
 ‘since John tried to repair the tractor’

However, the fact that a verb can occur in restructuring contexts is not problematic for the extended projection hypothesis. What’s important here is that the reduced structure of the infinitive in (45) is not an inherent property of the verb *reparieren* – the verb can project a full extended projection when it appears in a different context. The fact that its extended projection must be reduced in (45) is a fact of the restructuring verb *try* and its selectional properties. This state of

affairs in not problematic for the extended projection hypothesis, where the functional heads in (43) are treated as a property of the verbal category. The verb *reparieren*, being of that category can, in principle, project them all.

What *would* be surprising, however, is if we found a verb, or a set of verbs, which are inherently unable to project full clausal structure, or are able to project only a small fragment of it. For all I can tell, no lexical verb has that property. And for this reason, it seems justified to question the verbal nature of any element that would show such behavior – the alternative would be to abandon, or at least weaken, the Extended Projection Hypothesis, and thereby losing existing insights about the nature of the verbal category. Given the *systematic* non-projection of auxiliary verbs, the VP approach must resort to this exactly: they are verbs (i.e. element of category V) which may project as far as VP but not further. Such a claim is not supported by any other aspect of the theory, nor by empirical generalizations (no other verbs are systematically non-projecting). It is a stipulation which complicates the theory of categories and extended projections with no obvious benefits.

The non-projection approaches offer a more principled account to auxiliary verbs. The lack of projection follows from the fact that they are not of the same category as lexical verbs and so we do not expect them to ever be able to project full clausal structure. Instead, we expect them to project only the functional structure that typically occurs above the functional category they are associated with. This means that non-projection approaches not only avoid the limited-projection problem, but also are able to generate predictions about the amount of structure around the auxiliary verb – an issue I take up in the next section.

Before that, however, let me briefly consider a different treatment of auxiliary verbs, which seems to avoid the limited-projection problem. As mentioned before, auxiliary verbs are sometimes treated as elements of a different category than lexical verbs, namely Aux (this goes back to Chomsky's (1957) Aux hypothesis for auxiliary and modal verbs, argued for later by Steele et al. (1981) and Akmajian et al. (1979)). It is quite common in current literature, especially literature not dealing directly with periphrasis, to assume that an Auxiliary Phrase, AuxP, can be generated

in various position in the structure. However, it is very difficult to identify what we could call the AuxP approach. This is because, unlike the VP, FP and the Insertion approaches, it is used rather inconsistently, sometimes resembling the FP approach with a different label (e.g. Wurmbrand (2011) consistently uses AuxP for the functional head with the *iPerf* feature), but more often resembling the VP approach with the AuxP label (it looks like a VP approach because it is an *extra* projection, added to the regular functional structure of the clause). This latter use of AuxP has been also assumed for Bantu languages, e.g. in Henderson (2006) and Baker & Willie (2010)), where the assumed structure of compound is as in (46).

- (46) a. [AuxP Aux (*auxiliary verb*) [AspP *participle* ]] (Henderson, 2006)  
 b. [AuxP Aux (*auxiliary verb*) [PtcpP *participle* ]] (Baker & Willie, 2010)

Since auxiliaries are not Vs under this approach, it is unclear what predictions it makes about the auxiliary's projection, and for this reason the arguments against the VP approach presented in this section do not apply to the AuxP approach.

It is important to note, however, that the AuxP analyses in (46) are a version of the VP approach. Together with the VP approach, they fall in the class of projection approaches to auxiliary verbs. The difference is only in the category it projects, but otherwise its syntax is the same: the auxiliary verb is a special kind of verb which projects a phrasal level but has no extended projection. The AuxP approach "captures" this special nature of auxiliary verbs by labeling them Aux, rather than V. As such, the AuxP implementation of the VP approach does not offer a solution to the limited-projection problem. The remaining two challenges for the VP approach discussed in the next sections apply equally to the VP and the AuxP approach, and therefore I will not discuss them separately.

### 3.3 The selection problem

A question an analysis of auxiliary verbs should address concerns the form of the auxiliary's complement – the main verb. In Ndebele, both default and aspectual auxiliaries combine with participial forms of the main verb. We do, however, observe inflectional variation within the paradigm of participial forms used in auxiliary-verb constructions. In Ndebele, they include *imperfective participles*, *past participles* and *future participles*. Focusing on aspectual-verb constructions, I argue in this section that the FP approach *predicts* which type of participle may be selected by a particular aspectual auxiliary (default auxiliaries are not relevant in this discussion because they do not show selectional restrictions; see next subsection). The VP approach, on the other hand, must resort to lexical stipulations and is therefore unexplanatory.

#### 3.3.1 Deriving selectional patterns from Infl-agreement

All three types of participles are found in compound tenses, i.e. as complements of default auxiliaries, and are illustrated in (47). Aspectual verbs, on the other hand, can take either imperfective or past participles, as shown in (48).<sup>14</sup>

(47) Compound tenses

- |    |                        |                   |                                |
|----|------------------------|-------------------|--------------------------------|
| a. | U-∅-be                 | e-bala            | <i>imperfective participle</i> |
|    | 1s-PST-AUX             | 1s-read.IMPF.PTCP |                                |
|    | 'He was reading'       |                   |                                |
| b. | U-∅-be                 | e-balile          | <i>past participle</i>         |
|    | 1s-PST-AUX             | 1s-read.PST.PTCP  |                                |
|    | 'He had read'          |                   |                                |
| c. | U-∅-be                 | e-zabala          | <i>future participle</i>       |
|    | 1s-PST-AUX             | 1s-read.FUT.PTCP  |                                |
|    | 'He was going to read' |                   |                                |

---

14. I believe that the absence of future participles with aspectual auxiliaries is an accidental gap – the small set of aspectual auxiliaries we find in Ndebele happens to not include an auxiliary which combines with a future participle.

(48) Aspectual-auxiliary constructions

- a. U-lokhe e-bala *imperfective participle*  
1s-still 1s-read.IMPF.PTCP  
'He is still reading'
- b. U-hlezi e-bala *imperfective participle*  
1s-constantly 1s-read.IMPF.PTCP  
'He is constantly reading'
- c. U-se e-balile *past participle*  
1s-already 1s-read.PST.PTCP  
'He has already read'

Analyses assuming the VP approach model this variation as selection: each auxiliary verb is lexically specified as selecting for particular type of participle. For instance, the auxiliary *lokhe* 'still' is a verb with a selectional feature specified for *imperfective participle* (49-a). The selectional requirements of the default auxiliary *be* are less strict – it can combine with any type of participial form (49-b).

- (49) a. *lokhe*  $\left[ \begin{array}{l} \text{CAT: V} \\ \text{SEL: **Impf Ptcp**} \end{array} \right]$                       b. *be*  $\left[ \begin{array}{l} \text{CAT: V} \\ \text{SEL: **Ptcp**} \end{array} \right]$

Similarly, the verb *hlezi* in (48-b) would select for an imperfective participle, while the verb *se* in (48-c) for a past participle. Thus, the VP approach offers a straightforward way of accounting for the form of the main verb in auxiliary-verb constructions.

Importantly, however, the observed patterns of selection in aspectual-verb constructions are not entirely unpredictable. Assuming the FP approach, I proposed in the previous section that each aspectual auxiliary is generated as a particular inflectional head, shown in (50) (repeated from (23)).

- (50)  $[ T^0 [ \text{Perf}^0 \textit{se} 'already' [  $\text{Asp}^0_{\text{IMPF}}$  *lokhe* 'still' / *hlezi* 'constantly' [  $\text{Voice}^0$  ... ] ] ] ]$



The fact that *lokhe* and *hlezi* select for imperfective participles correlates with the fact that they themselves occupy an imperfective Asp head. The verb *se*, on the other hand, is associated with a different type of inflectional head, Perf<sup>0</sup>, and selects for a past participle (also referred to as perfect participle). Given this, the selectional patterns do not strike us as lexical idiosyncrasies of each aspectual verb. Rather, they follow from the properties of the inflectional head that each auxiliary verb occupies. These correlations are lost under the VP approach, in which aspectual auxiliaries are simply verbs and their complement must be specified via selection.

To account for selected morphology in aspectual-verb constructions, I adopt the view that verbal inflectional features participate in agreement (Adger, 2003; Wurmbrand, 2011; Bjorkman, 2011). I assume that all lexical verbs have an unvalued Infl-feature: Infl:\_\_\_, while inflectional heads, such as T and Asp have a valued Infl-feature (inflectional heads might also be unmarked, in which case they lack an Infl-feature altogether). The inventory of Infl-features for different categories in Ndebele is presented in (51).

(51) Infl-inventory in Ndebele

- a. T<sup>0</sup>: Infl:{PST, FUT} (present tense is unmarked)
- b. Perf<sup>0</sup>: Infl:PST<sup>15</sup>
- c. Asp<sup>0</sup>: Infl:IMPF (perfective aspect is unmarked)

As indicated in (51), I assume that present tense and perfective aspect are unmarked inflections for their respective heads. I assume that a syntactically unmarked inflectional head is one which lack an inflectional feature (Cowper, 2005; Bjorkman, 2011). This is to say, present tense is encoded by a T without an Infl-feature, and perfective aspect is an Asp head without an Infl-feature. This aspect of the analysis will only become relevant in the discussion of default periphrasis in the next chapter. Additionally, I assume that the inflectional feature of Perf<sup>0</sup> is PST, following previous

---

15. The analysis of perfect aspect will be revised in chapter 4. I will treat it as a lower T head which may host not only Infl:PST (giving rise to what we call perfect aspect) but also Infl:FUT (the so called prospective aspect). This simpler formulation is sufficient for the purposes of this chapter

insights into the nature of the perfect which reveal its semantic and morphological affinity to past tense (for a more detailed discussion, see chapter 4 section 4).

Let us first see a simple case of Infl-agreement. In simple tenses, such as the Simple Future in (52), T has Infl:FUT, while the verb has an unvalued Infl. I assume that the unvalued Infl is not located on the lexical root (notated here as V), but on the category-introducing head, namely little v (53-a), which I treat as the head realized by the Final Suffix. I further assume that probing is directed upwards (Adger, 2003; Wurmbrand, 2011; Merchant, 2011; Bjorkman, 2011; Bjorkman & Zeijlstra, 2014).<sup>16</sup> The probe in (53-a), the unvalued Infl on v, is c-commanded by an agreement goal, the valued Infl on T.

- (52) Ngi-za-bal-a.  
 1sg.s-FUT-read-FS  
 ‘I will read’

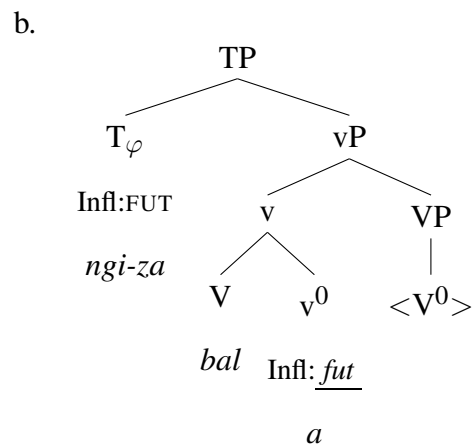
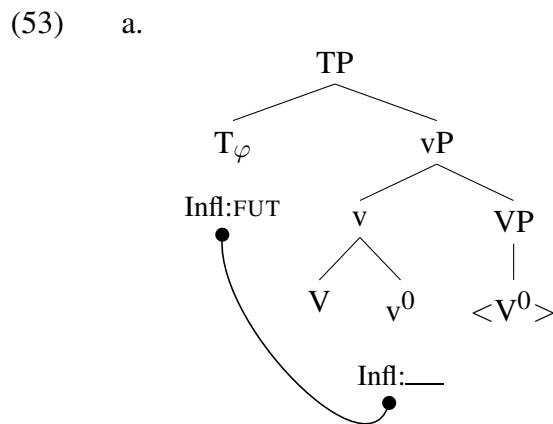

The Agree relation established between T and v results in valuation (53-b). Thus, the locus of

16. The directionality of Agree has been debated in recent literature. The original formulation of Agree Chomsky (2000, 2001) as a downward probing was challenged by in later literature, where Agree was proposed be directed upwards or apply in both directions (Adger, 2003; Baker, 2008; Wurmbrand, 2011; Merchant, 2011; Bjorkman, 2011; Bjorkman & Zeijlstra, 2014, a.o.), but also defended (Preminger & Polinsky, 2015). While in the domain of  $\varphi$ -agreement the issue remains controversial, agreement between inflectional features in the verbal domain systematically shows valuation of a lower head by a higher one.

Infl-covariation is  $v^0$  – the head expounded by the final suffix. To see a different case, consider the Recent Past tense (54). In Recent Past, there is no overt tense prefix, but the past tense feature is reflected on the final suffix. The derivation proceeds as with Simple Future: [Infl:\_\_\_] on  $v$  agrees with the valued Infl on T and is reflected in the form of the final suffix.

- (54) Ngi- $\emptyset$ -bal-ile.  
 1sg.s-PST-read-FS.PST  
 ‘I read (recently)’

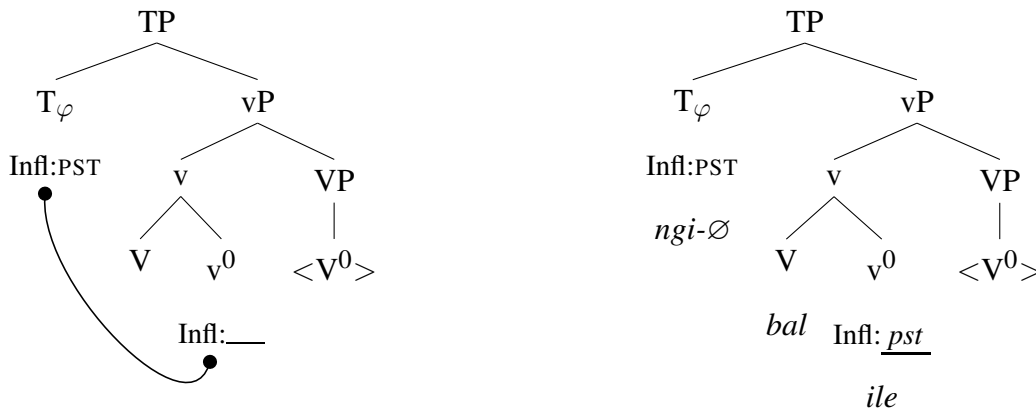

Let us return to aspectual auxiliaries. As proposed before, they each correspond to a specific inflectional head. Given our current assumptions about Infl-features, aspectual auxiliaries are also associated with specific Infl-features: those features which appear on the head they are located in. In particular, *se* ‘already’ has Infl:PST because it is located in  $\text{Perf}^0$ , while *hlezi* ‘constantly’ and *lokhe* ‘still’ have Infl:IMPF since they spell out an imperfective Asp head. The Infl-features of aspectual auxiliaries is summarized in (55).

- (55) Infl-features of aspectual auxiliaries
- se* ‘already’ (in  $\text{Perf}^0$ ): Infl:PST
  - lokhe* ‘still’ (in  $\text{Asp}^0$ ): Infl:IMPF
  - hlezi* ‘constantly’ (in  $\text{Asp}^0$ ): Infl:IMPF

Since the complement of aspectual auxiliaries is a lexical verb, it has an unvalued Infl-feature. Thus, the Infl-feature associated with an aspectual auxiliary can determine the Infl-value on its complement via Infl-agreement. This is illustrated for each aspectual auxiliary below.

- (56) U-lokhe e-bala.  
 1s-still 1s-read.IMPF.PTCP  
 'He is still reading'

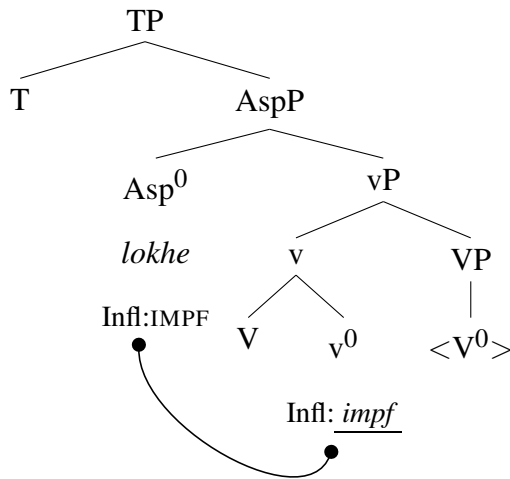

- (57) U-hlezi e-bala.  
 1s-constantly 1s-read.IMPF.PTCP  
 'He constantly reads'

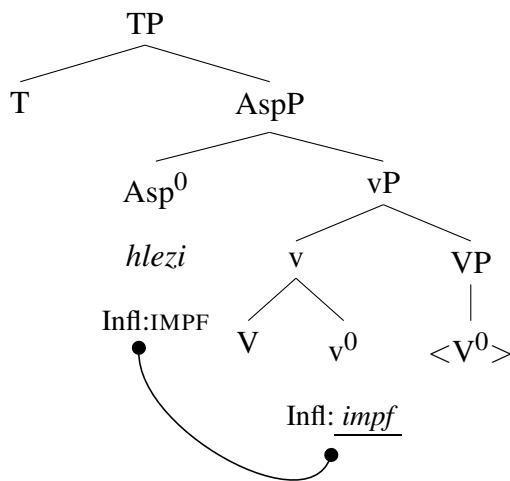

- (58) U-se e-bal-ile.  
 1s-already 1s-read.PST.PTCP  
 'He has already read'

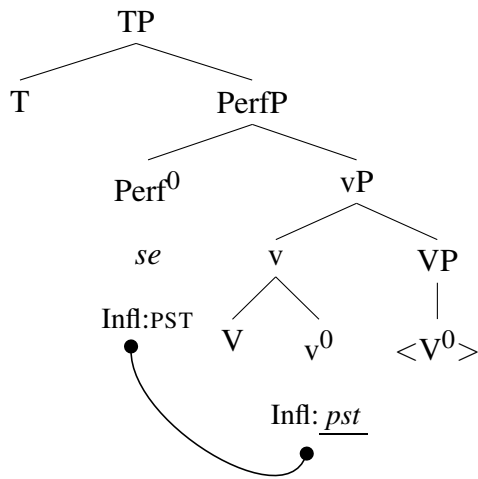

Thus, adopting the FP approach to aspectual auxiliaries allows us to derive the selected forms: *lokhe* and *hlezi* combine with imperfective forms because this is the Infl-value they assign to them by agreement. The verb *se* is in Perf<sup>0</sup>, and so it values the main as PST, triggering the appearance of a past participle. Note that I do not treat the participial form itself as a morphosyntactic feature and assume instead that it is the default form of the complement of an auxiliary. I address this issue again in chapter 6, where I make explicit distinction between inflectional categories, such as imperfective aspect, and metacategories, such as participial and subjunctive forms.

In addition to capturing the correlation between the type of aspectual auxiliary and the form of its complement, the FP approach has another advantage over the VP approach. Since, according to the present analysis, aspectual auxiliaries are located in fixed positions in the clausal spine, we can make predictions about i) possible variation in size of their complement and ii) about possible co-occurrences of aspectual auxiliaries. Below I discuss what the prediction are exactly and show that they are borne out, providing further support for the proposed implementation of the FP approach.

### 3.3.2 Prediction 1: the extent of selectional optionality

We have concluded in the previous subsection that the form of an aspectual auxiliary's complement follows from the position of the auxiliary in the clausal spine. For instance, the verb *lokhe* 'still' takes an imperfective participle as its complement because it is itself located in an imperfective Asp head and assigns the relevant inflection (Infl:IMPF) to the main verb by agreement. Modeling complement selection in aspectual-verb constructions as the result of agreement has an additional advantage: it predicts the pattern of selectional flexibility in aspectual auxiliaries.

I have shown before that the aspectual verb *se* takes a past participle as its complement. But, in fact, it is also compatible with an imperfective participle, as we see in (59).<sup>17</sup> The verbs *lokhe* 'still' and *hlezi* 'constantly', on the other hand, show no such flexibility – they can only combine with imperfective participles (60)-(61).

(59) Selectional flexibility with *se* 'already'

- |    |                               |            |                   |                                  |
|----|-------------------------------|------------|-------------------|----------------------------------|
| a. | U-∅-be                        | e-se       | e-bala            | ✓ <i>imperfective participle</i> |
|    | 1s-PST-AUX                    | 1s-already | 1s-read.IMPF.PTCP |                                  |
|    | 'He had already been reading' |            |                   |                                  |
| b. | U-∅-be                        | e-se       | e-balile          | ✓ <i>past participle</i>         |
|    | 1s-PST-AUX                    | 1s-already | 1s-read.PST.PTCP  |                                  |
|    | 'He had already read'         |            |                   |                                  |

(60) No selectional flexibility with *lokhe* 'still'

- |    |                        |          |                   |                                  |
|----|------------------------|----------|-------------------|----------------------------------|
| a. | U-∅-be                 | e-lokhe  | e-bala            | ✓ <i>imperfective participle</i> |
|    | 1s-PST-AUX             | 1s-still | 1s-read.IMPF.PTCP |                                  |
|    | 'He was still reading' |          |                   |                                  |

---

17. These examples additionally involve a past tense expressed on a default auxiliary preceding the aspectual verb. This choice is due to the fact that the meaning of *se* in the present tense fluctuates between what we would translate as 'already' or 'now' and there is some inconsistency in translation among speakers (an issue I have no explanation for currently). In the past tense, however, the judgments are consistent and *se* is translated as 'already'. I choose the past tense paradigm here to keep the two sentences in (59) a semantic minimal pair. Parallel example with *lokhe* and *hlezi* in (60) and (61) also past tense for consistency with (59).

- b. \*U-∅-be      e-lokhe e-balile      *\*past participle*  
 1s-PST-AUX 1s-still 1s-read.PST.PTCP

(61) No selectional flexibility with *hlezi* ‘constantly’

- a. U-∅-be      e-hlezi      e-bala      ✓ *imperfective participle*  
 1s-PST-AUX 1s-constantly 1s-read.IMPF.PTCP  
 ‘He was constantly reading’

- b. \*U-∅-be      e-hlezi      e-balile      *\*past participle*  
 1s-PST-AUX 1s-constantly 1s-read.PST.PTCP

Modeling the selection patterns in (59)-(61) under the VP approach would require positing some sort of optionality of selection for *se*, but not for *lokhe* and *hlezi*. Such stipulations are completely avoided under the FP approach proposed here, which *predicts* exactly this pattern complement selection.

The prediction follows from the Perfect-over-Asp generalization discussed above: perfect aspect is universally a higher category than viewpoint aspect (e.g. the imperfective viewpoint aspect). This means that an auxiliary verb which spells out Perf, such as *se* in Ndebele, does not have to be the most local inflectional head to the main verb – Asp can intervene. It is precisely in this case that *se* combines with an imperfective participle. The structure in (62) shows the derivation: *se* is projected in Perf, as usual, but it cannot control agreement on the main verb because of an intervening inflection, namely the imperfective Asp head. Instead, the main verb’s Infl-feature is valued as IMPF by Asp due to locality. In the absence of imperfective aspect, the Asp head is either not projected or is unmarked (has no Infl-feature). This is the case where the head spelled out by *se* is the closest goal and determines the Infl-value on the main verb, giving rise to a past participle (63).

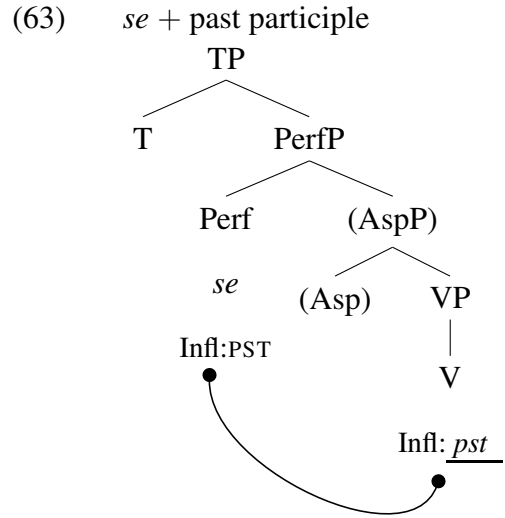
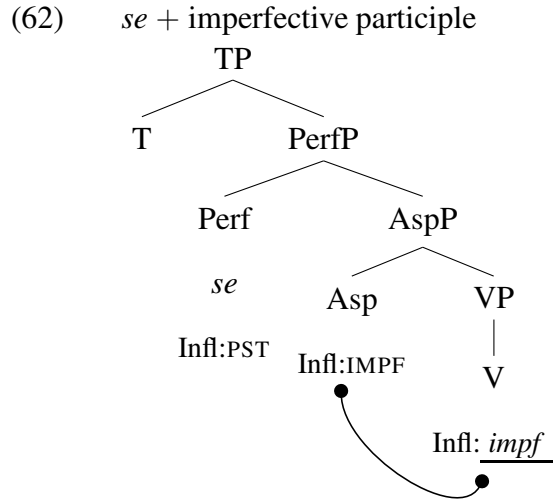

Given that *lokhe* and *hlezi* are associated with Asp, we predict that their complement may never be a past participle. Like before, the prediction follows from the Perfect-over-Asp generalization and locality of agreement. Thus, the FP approach derives the fact that both *lokhe* and *hlezi* can only take imperfective participles as complements (64).

(64) *lokhe* and *hlezi* require an imperfective participle

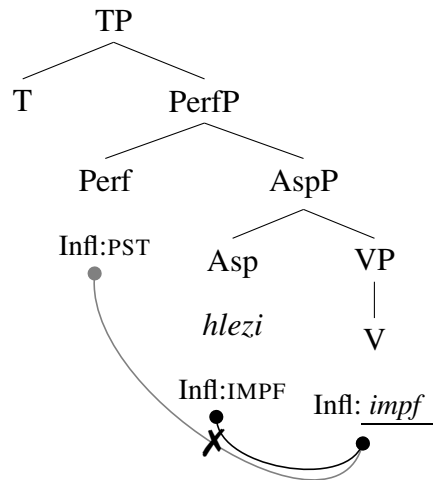
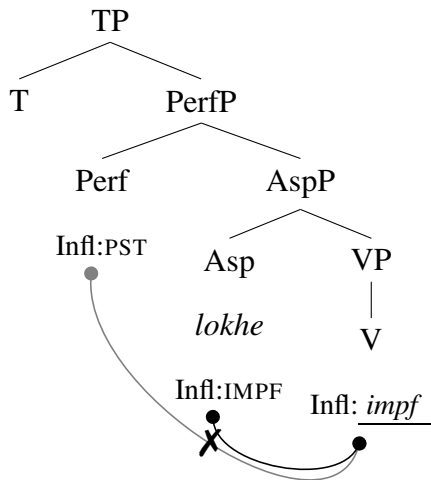



### 3.3.3 Prediction 2: possible cooccurrences of aspectual auxiliaries

A prediction related to selectional flexibility concerns possible cooccurrences between aspectual auxiliaries. Again, the Perfect-over-Asp generalization is important. It predicts that the auxiliary verbs *lokhe* and *hlezi*, located in Asp, cannot take *se* as a complement because *se* spells out Perf – a higher inflectional head (65).

(65) [ T<sup>0</sup> [ Perf<sup>0</sup> *se* ‘already’ [ Asp<sup>0</sup><sub>IMPF</sub> *lokhe* ‘still’ / *hlezi* ‘constantly’ [ Voice<sup>0</sup> ... ]]]]

As shown in (66), this prediction is borne out. Neither of the Asp-associated auxiliaries can take *se* as its complement. Note that this ordering is ungrammatical whether the complement of *se* is a past participle or an imperfective participle.

(66) \**lokhe/hlezi* + *se*

- a. \*Ngi-*lokhe* (ngi)-*se*      ngi-*pheka/ngi-phekile*.  
1sg.s-still 1sg.s-already 1sg.s-cook.IMPF.PTCP/1sg.s-cook.PST.PTCP
- b. \*Ngi-*hlezi*      (ngi)-*se*      ngi-*pheka/ngi-phekile*.  
1sg.s-constantly 1sg.s-already 1sg.s-cook.IMPF.PTCP/1sg.s-cook.PST.PTCP

The reverse order, i.e. *se* over *lokhe/hlezi*, is not predicted to be ungrammatical. As we see in (67), *se* can indeed combine with both of *lokhe* and *hlezi*.

(67) *se* + *lokhe/hlezi*

- a. Ø-*se*      ngi-*lokhe* ngi-*pheka*  
1sg.s-already 1sg.s-still 1sg.s-cook  
‘I am still cooking (now)’
- b. Ø-*se*      ngi-*hlezi*      ngi-*pheka*  
1sg.s-already 1sg.s-constantly 1sg.s-cook  
‘I constantly cook now’

The relative ordering of the two Asp-associated auxiliaries appears to be unrestricted: *lokhe* and

*hlezi* can cooccur in either order (68), though (68-a) is judged as more natural by some speakers.

(68) *lokhe* >< *hlezi*

- a. Ngi-*lokhe* ngi-*hlezi*      ngi-*pheka*  
 1sg.s-still 1sg.s-constantly 1sg.s-cook.IMPF.PTCP  
 'I still (have to) cook constantly'
- b. ?Ngi-*hlezi*      ngi-*lokhe* ngi-*pheka*  
 1sg.s-constantly 1sg.s-still 1sg.s-cook.IMPF.PTCP  
 'I still (have to) cook constantly'

As mentioned before, the two verbs in (68) may actually correspond to different Asp heads associated with imperfective-like meaning in Cinque's hierarchy. I do not commit to placing these verbs in specific positions in Cinque's hierarchy since I found no reliable diagnostic for making such a detailed choice. The fact that they can cooccur should perhaps be treated as evidence there are (at least) two aspectual heads in the clausal structure of Ndebele and that each of them can host an aspectual auxiliary with an imperfective-like meaning, as in (69).

(69) [ T [ Perf *se* [ Asp1<sub>IMPF</sub> {*lokhe/hlezi*} [ Asp2<sub>IMPF</sub> {*lokhe/hlezi*} [ Voice<sup>0</sup> ... ]]]]]

Whatever the ordering of *hlezi* and *lokhe*, they are still both associated with a type of Asp head and as such are predicted to never precede *se* – a correct prediction.

As with participle-selection, the VP approach does not make predictions about which orderings of aspectual auxiliaries should be possible and which not. It would again have to resort to stipulating them as selectional properties of individual auxiliary verbs. Moreover, the selectional statements needed to account for cooccurrence patterns must be made *in addition* to statements about participle-selection discussed in the previous subsection. This would fail to capture clear correlations between the two phenomena. For instance, the fact that *lokhe* and *hlezi* cannot select for a past participle would have nothing to do with the fact that they also cannot take *se* as a complement. Under the FP approach developed here, these two facts follow from the proposal

in (69), and in particular, the ordering of perfect aspect over viewpoint aspect in the functional hierarchy. In sum, cooccurrence restrictions and participle selection patterns are predictable and have the same source in the present account: the Perfect-over-Asp generalization and locality of agreement.

### 3.4 The overflow problem

In this section, I present a challenge for the VP approach discussed at length by Bjorkman (2011), namely the so called *overflow pattern* of auxiliary use. This pattern refers to a special distribution of default auxiliaries in compound tenses: one where no inflectional category (e.g. Prog or Perf) systematically requires an auxiliary verb. As Bjorkman argued, this pattern is problematic for any approach to periphrasis in which the relationship between the auxiliary verb and the participle is selection.

As discussed in previous subsections, the VP approach assumes that auxiliaries are verbs which select for participles. For instance, the English auxiliary *be* can select for a progressive participle (which I label PartP in (71)). This is true for all progressive tenses in English (70).

- (70) a. He *is* reading. *Present Progressive*  
 b. He *was* reading. *Past Progressive*  
 c. He will *be* reading. *Future Progressive*

(71) English progressive tenses: VP approach

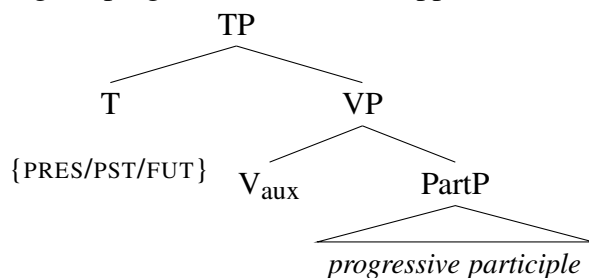

A selection-based analysis, such as (71), predicts systematic association of certain inflectional

categories with auxiliary verbs. In languages like English, this is indeed the case: as we saw in (70), all progressive tenses in English require an auxiliary verb; similarly, all perfect tenses are periphrastic, as well (72).

- |      |    |                           |                        |
|------|----|---------------------------|------------------------|
| (72) | a. | He <i>has</i> read.       | <i>Present Perfect</i> |
|      | b. | He <i>had</i> read.       | <i>Past Perfect</i>    |
|      | c. | He will <i>have</i> read. | <i>Future Perfect</i>  |

If the two categories cooccur (to form perfect progressive tenses), the whole expression must contain two auxiliary verbs – one for each inflection (73).

- |      |    |                                   |                                    |
|------|----|-----------------------------------|------------------------------------|
| (73) | a. | He <i>has been</i> reading.       | <i>Present Perfect Progressive</i> |
|      | b. | He <i>had been</i> reading.       | <i>Past Perfect Progressive</i>    |
|      | c. | He will <i>have been</i> reading. | <i>Future Perfect Progressive</i>  |

The distribution of auxiliaries we see in (70), (72) and (73) is referred to in Bjorkman (2011) as the *additive pattern* of auxiliary use. This type of pattern, where every inflectional category systematically requires an auxiliary, is consistent with the VP approach, in which the relation between inflection and auxiliary verbs is modeled as selection.

A crosslinguistic picture of periphrasis is different, however. Bjorkman discusses a number of languages in which no such systematic association is observed. In Kinande (Bantu), for instance, progressive aspect does not by itself require an auxiliary verb. As we see in (74-a), Present Progressive is a synthetic tense. Similarly, past tense inflection on its own also doesn't involve an auxiliary verb (74-b). Periphrasis is required, however, when the two inflections cooccur (74-c).

- |      |   |   |                            |
|------|---|---|----------------------------|
| (74) | The overflow pattern in Kinande (Bjorkman, 2011:87) |   |                            |
|      | a.  | tu-ne:mu-húma<br>1pl-PROG-hit<br>'We are hitting' | <i>Present Progressive</i> |

- b. tw-á-húma *Recent Past*  
 1pl-PST-hit  
 ‘We hit (recently, not today)’
- c. tw-á-**bya** i-tu-ne:mu-húma *Recent Past Progressive*  
 1pl-PST-AUX LNK-1pl-PROG-hit  
 ‘We were (recently, not today) hitting.’

Compound tenses in Ndebele show exactly the same pattern of auxiliary use: an auxiliary verb is only present if the progressive and past tense inflections cooccur (75).

(75) The overflow pattern in Ndebele

- a. U- bala ibhuku. *Present Progressive*  
 2sg- read 5book  
 ‘You are reading a book’
- b. U- a- bala. *Simple Future*  
 2sg- DPST- read  
 ‘You read (long ago)’
- c. U- a- **be** u-bala. *Future Progressive*  
 2sg- DPST- AUX 2sg-read  
 ‘You were reading (long ago)’

Note that, unlike Kinande, Ndebele doesn’t have specific morphological marking of the progressive aspect. For this reason, one could argue that the synthetic expression in (75-a) does not contain a progressive inflection, but rather is an underspecified present tense compatible with a progressive interpretation. However, non-present tenses, where the progressive interpretation requires periphrasis, are evidence that the progressive is indeed an inflectional category in this language. Under the VP or the FP approach, the puzzling case would be the fact that this category apparently cannot cooccur with present tense, since there is no periphrastic expression of progressive aspect in the present.

An important feature of the overflow pattern is that auxiliary syntax cannot be attributed to any specific inflection. In English, we could say that an auxiliary is required because progressive

aspect is selected by an auxiliary verb. In Kinande or Ndebele, no such statement can be made – progressive aspect does not require an auxiliary verb in the present tense. In other words, the presence of *bya* ‘be’ in the Kinande Recent Past Progressive (74-c) is neither due to the progressive inflection nor due to past tense inflection. Instead, we need an account of periphrasis in which the distribution of auxiliary verbs is a consequence of certain *combinations* of inflectional categories. A selection-based account, such as the VP approach, is not such an account. There, progressive aspect is either selected by an auxiliary or not, predicting either systematic cooccurrence or systematic non-occurrence of the two. The higher inflection, here tense, is merged after this selectional choice is made and therefore is should not be able to condition it. But this is exactly the case in Kinande: a progressive tense can in principle be periphrastic, but this is ultimately determined by the inflection on T. Adapting a selection-based account to the overflow pattern would require introducing a mechanism of optional selection in which merge of an auxiliary on top of the progressive participle is determined countercyclically, i.e. by a category merged above the auxiliary. This look-ahead problem is the main challenge posed by the overflow pattern for the VP approach.

As Bjorkman points out, the FP approach does not handle the overflow pattern either. Even though auxiliaries under the FP approach are not verbs selecting participles, they are still base-generated, this time as functional heads. The English progressive tenses, for instance, would have the structure in (76).

(76) English progressive tenses: FP approach

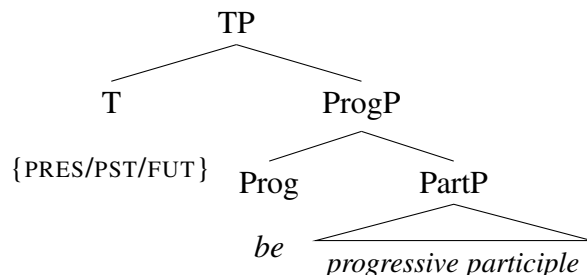

Under the analysis in (76), the auxiliary verb is a property of the Prog head – it is generated in

that functional heads. As such, the FP account also predicts that all progressive tenses, which contain ProgP, must be periphrastic. The problem posed by the overflow pattern lies in systematic cooccurrence, whether it stems from a selection relation between auxiliaries and inflections (the VP approach) or from base generation of an auxiliary and an inflection together (the FP approach). Thus, neither of the two approach is fit to account for the overflow distribution of auxiliaries.

Based on facts like the Kinande paradigm, Bjorkman argues that auxiliary verbs in compound tenses, *default auxiliaries*, are not generated in the syntax, either as Vs or as functional heads. Rather, periphrasis is a result of post-syntactic insertion of a default verb in an inflectional category that could not combine with the main verb in the syntax. Leaving details aside for the moment, this general approach of periphrasis has been proposed also e.g. by Bach (1967), Embick (2000), Cowper (2010) and Arregi & Klecha (2015), and I refer to it as the Insertion Approach. What previous proposals in this vein have in common is the treatment of periphrasis as a last-resort phenomenon, in which a default verb is inserted in the derivation just in case some well-formedness condition is not met. They differ in how this well-formedness condition is defined and in the precise implementation of auxiliary insertion. The next chapter is devoted to default periphrasis. Building on previous insights about its last resort profile, I develop an analysis of Ndebele compound tenses, which, like Kinande, show the overflow pattern.

### **3.5 A formal representation of non-projecting verbs**

The arguments presented in this chapter point to the conclusion that neither aspectual nor default auxiliaries behave like lexical verbs. I proposed that the defining property of auxiliaries, which sets them apart from lexical verbs, is their non-projecting nature, i.e. the fact they cannot have a full extended projection, like lexical verbs. Given this, there is no evidence or reason to think that they project even a VP. In fact, such a limited projection would be unexpected behavior from a projecting verb.

But what is it exactly that makes some verb inherently unable to project? More specifically,

how is this property auxiliaries related to the hypothesis that they are generated in a functional head, or inserted derivationally? This section is devoted to formally identifying non-projecting verbs. I propose in the next subsection that the projection/non-projection property is determined by the position they occupy in the extended projection, which in turn is in part specified by the auxiliary's category feature. In subsection 3.5.2, I consider the possibility that auxiliary verbs are, in fact, not verbs in any meaningful sense, and that the differences between them and lexical verbs discussed here are due to that fact. I argue that the traditional characterization of auxiliaries in Ndebele as verbal elements is motivated and that discarding the connection to the verbal category brings about new problems.

### *3.5.1 The category of non-projecting verbs*

I assume the view of the clausal spine as an instance of a Hierarchy of Projections, built according to a universal ordering of functional projections organized around a particular category (Abney, 1987; Grimshaw, 1991, 2000; Cinque, 1998, 1999). A specific implementation of this type of structure building was proposed by Adger (2010). According to him, functional heads that belong to a hierarchy of projections are inherently specified for the position they occupy in the hierarchy. This information is encoded in their category feature, which, according to Adger is an ordered pair of a category label and a natural number (77).

- (77) The value of CAT is an ordered pair  $\langle \text{Cat}, n \rangle$ , where
- a. Cat is category label from the set: {v, Voice, T, etc.}
  - b. n is a natural number  $\geq 0$  (adapted from Adger (2010))

Additionally, a Hierarchy of Projections is organized around a category (in the sense of Grimshaw's extended projection (Grimshaw, 1991, 2000)). In the verbal domain, the hierarchy is organized around the verbal category in the sense that the first element of the hierarchy is of category V, as



shown in (78).<sup>18</sup>

(78) Hierarchy of Projections in the verbal domain (adapted from Adger (2010)):

$\langle V,1 \rangle < \langle v,2 \rangle < \langle \text{Voice},3 \rangle < \langle \text{Asp},4 \rangle < \langle \text{Perf},5 \rangle < \langle \text{Mod},6 \rangle < \langle \text{Neg},7 \rangle < \langle T,8 \rangle < \langle \text{Fin},9 \rangle < \langle C,10 \rangle$

Under this view, the category feature is not the category label alone – the level is equally important in specifying the category as it determines in which position a given head may be merged. Thus, the category of a verb is  $\langle V,1 \rangle$ . This is the formal definition of a *projecting verb*: being of category  $\langle V,1 \rangle$ . Combined with the assumption that verbs also have an unvalued Infl-feature, the featural composition of a lexical, projecting verb looks as in (79).

(79) A projecting verb:

$$\left[ \begin{array}{l} \text{CAT: } \langle V,1 \rangle \\ \text{Infl: } \text{—} \end{array} \right]$$

Functional heads in the verb's extended projection, on the other hand, have valued Infl-features (or in some cases no Infl-feature, if they are unmarked; this will become relevant in the next chapter.) A proposed list of lexical entries for projections in the Ndebele verbal hierarchy is represented in the structure below (80) (functional heads above T will not play a role in the present discussion).

(80) Ndebele verbal functional hierarchy (revised in (84)):

$\langle V,1 \rangle < \langle \text{Voice},2 \rangle < \langle \text{Asp},3 \rangle < \langle \text{Perf},4 \rangle < \langle T,5 \rangle$

---

18. Note that in Grimshaw's terms, all subsequent categories (v, Voice, Asp, etc.) are also of category V, and the different properties of those higher heads are a function of their level, encoded by the number. This is not the formalization I adopt and I assume that the first element of the ordered pair comes from the set of labels such as Voice and Asp.

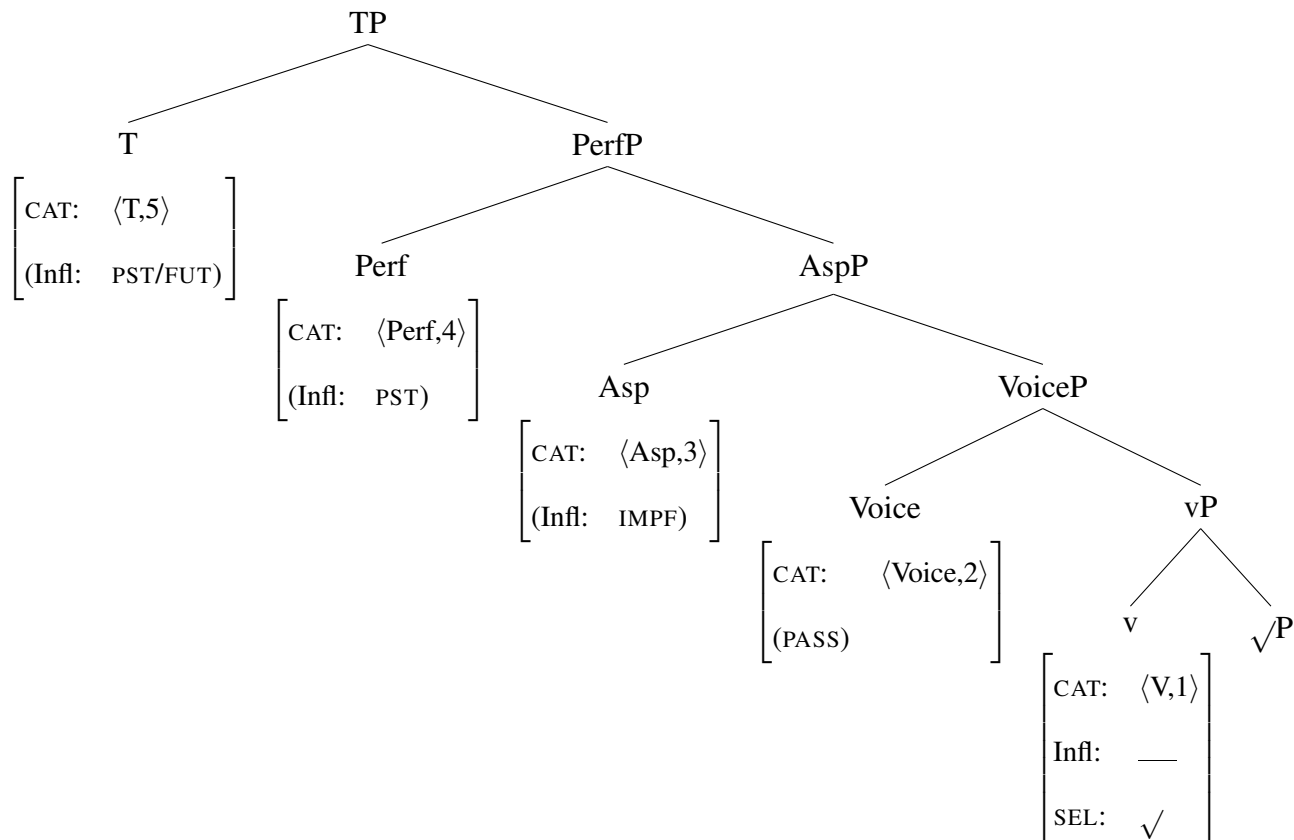

As we see in (80), I take little *v*, not the lexical *V*, to be the category introducing head, i.e. the first element of the verbal extended projection, and assume that the lexical verb is an acategorical root. Thus, the precise characterization of a projecting verb should be as a lexical root combined with the verbal category:  $\langle V,1 \rangle$ . In addition to the category label such as *Asp* or *T*, the category of higher heads in the hierarchy is specified by their level – the position in the hierarchy encoded by the second element of the ordered-pair value of the *CAT* feature. This part of their representation is important as it plays a role in functional structure building. Following Adger (2010), I assume that functional hierarchies are built by a special type of Merge which is sensitive to the category’s level value. Adger calls this operation *HoP-Merge* – a Merge operation responsible for building Hierarchies of Projection (HoPs).<sup>19</sup> *HoP-Merge* is defined in the following way (I assume that category features are shared by heads and their projections, ensuring that *HoP-Merge* can merge a

19. In chapter 4, I discuss *HoP-Merge* in relation to another structure-building operation, *Sel-Merge*, and argue that their interaction determines synthesis and periphrasis.

phrasal complement):

(81) **HoP-Merge** (adapted from Adger (2010))

If  $\alpha$  and  $\beta$  are syntactic objects such that  
the value of CAT in  $\alpha$  is  $\langle X, n \rangle$  and the value of CAT in  $\beta$  is  $\langle Y, m \rangle$ ,  
 $\langle X, n \rangle$  and  $\langle Y, m \rangle$  are in  $K_H$  (categorial feature values in hierarchy H), and  
 $n > m > 0$   
then  $\{\alpha, \{\alpha, \beta\}\}$  is a syntactic object.

According to the definition in (81), syntactic objects  $\alpha$  and  $\beta$  may form a constituent headed by  $\alpha$ , if their category features belong to the same hierarchy of projections and the numerical value of  $\alpha$ 's CAT-feature is larger than the value of  $\beta$ 's CAT-feature. Additionally, both values must be larger than 0, a provision that will become relevant in the discussion of default auxiliaries later in this section. The " $n > m > 0$ " condition on HoP-Merge is satisfied for all heads in the extended projection shown in (80). Note that the merge operation combining the  $v$  and the lexical root is not HoP-Merge; rather it is licensed by the selectional feature on  $v$  (*Sel-Merge*, see chapter 4).

Thus, the ability of main verbs to have a full extended projection stems from their level specification, namely  $\langle V, 1 \rangle$ : a projecting verb is the first member of the Hierarchy of Projections, and therefore all other elements of the hierarchy may be merged on top of it by HoP-Merge. In contrast, higher heads in the hierarchy can only project levels with larger numerical values of the CAT feature.

Turning to auxiliary verbs, the question arises as to their featural specification in the assumed system. Recall that they are non-projecting verbs in that they cannot have a full extended projection. I propose that verbs associated with functional heads (functional verbs), like Ndebele aspectual auxiliaries, have the category label V, but the level specification is that of the functional head they are associated with. For instance, the aspectual verb *lokhe* 'still', which is associated with an imperfective Asp head, has the entry in (83). Note that the only difference between a reg-

ular (non-verbal) imperfective Asp head and an Asp head hosting *lokhe* is the first element of the ordered-pair value of the CAT, feature. Their level is the same and the Infl-feature characteristic for that level is also found on both.

(82) Asp<sub>IMPF</sub> without auxiliary:

$$\left[ \begin{array}{l} \text{CAT: } \langle \text{Asp}, 3 \rangle \\ \text{Infl: } \text{IMPF} \end{array} \right]$$

(83) Asp<sub>IMPF</sub> hosting an auxiliary:

$$\left[ \begin{array}{l} \text{CAT: } \langle \text{V}, 3 \rangle \\ \text{Infl: } \text{IMPF} \end{array} \right]$$

Even though aspectual auxiliaries have a verbal feature, their projection is determined by the level value. Given that the value is higher than 1 (unlike on lexical verbs), aspectual verbs can only have a partial extended projection – they project exactly the same way as the verbless equivalent of that level (e.g. (82) for (83)). It is worth noting at this point, that the term *non-projecting* does not, strictly speaking, refer to a verb with no extended projection whatsoever. The auxiliary verb *lokhe* projects, but only functional categories higher than level 3. Instead, the term refers to a verb which can never have a full extended projection (the limited-projection problem of auxiliaries) and no extended projection independent of another verb's. Since *lokhe*'s category feature is specified for level 3, *lokhe* can never project e.g. Voice (which is of level 2), given the definition of HoP-Merge. This is what it means for aspectual auxiliaries to be non-projecting verbs.

This definition of functional verbs requires an amendment of the Hierarchy of Projections in the Ndebele clause. In addition to non-verbal functional levels, such as  $\langle \text{Asp}, 3 \rangle$ , the hierarchy must accommodate functional verbs, i.e. functional categories like  $\langle \text{V}, 3 \rangle$ . Below is the revised verbal hierarchy in Ndebele, which accommodates the aspectual verbs in this language: *lokhe* 'still' and *hlezi* 'constantly' (level 3), and *se* 'already' (level 4).

(84) Ndebele verbal functional hierarchy (revised):

$$\langle \text{V}, 1 \rangle < \langle \text{Voice}, 2 \rangle < \langle \text{Asp}, 3 \rangle, \langle \text{V}, 3 \rangle < \langle \text{Perf}, 4 \rangle, \langle \text{V}, 4 \rangle < \langle \text{T}, 5 \rangle$$

Notice that non-verbal Asp and verbal Asp can never cooccur in a functional hierarchy since they have the same level value, and HoP-Merge cannot apply to two objects with the same level value. Throughout the thesis, I often use the traditional labels for functional heads, such as Asp and Perf, even if the relevant functional level is verbal, i.e. hosts an aspectual auxiliary. So, if Asp hosts the verb *lokhe*, for instance, I still label it Asp, but indicate its verbal nature by including the verbal category feature on the terminal (85). If it a functional head does not host an aspectual auxiliary, I typically omit the category feature (86).

(85) Notation abbreviations: Verbal functional heads (aspectual auxiliaries)

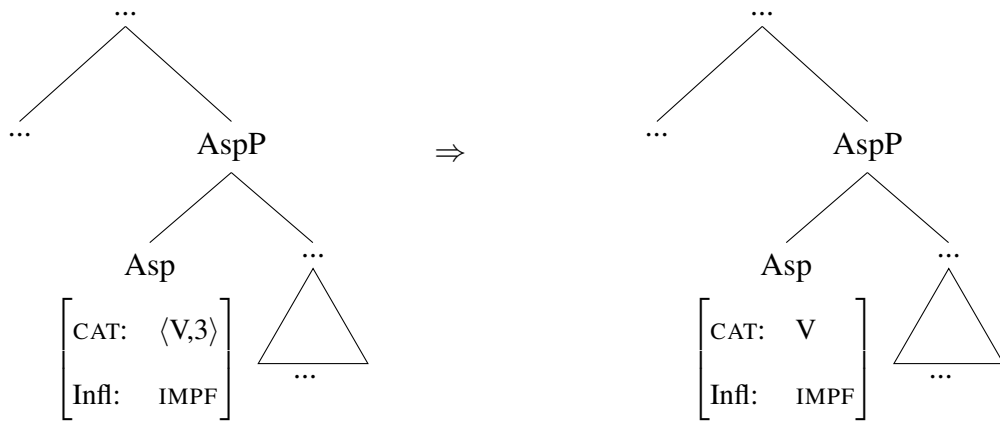

(86) Notation abbreviations: Non-verbal functional heads

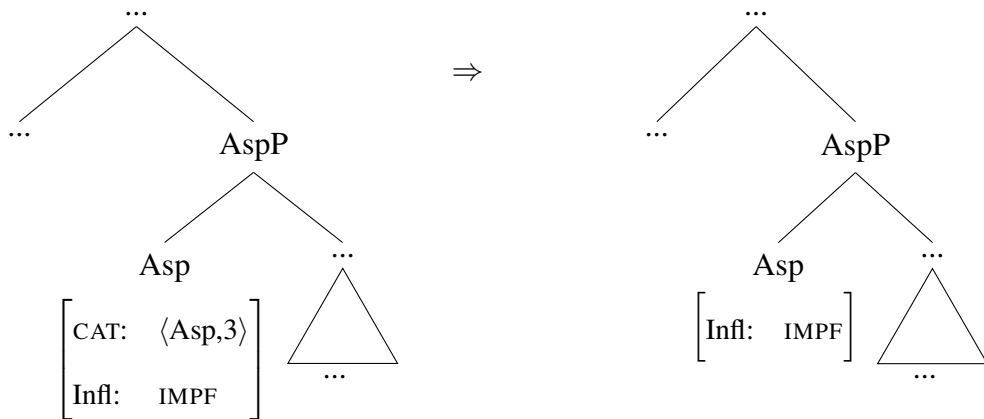

Another type of non-projecting verb is the default auxiliary used in compound tenses. We have seen that default auxiliaries cannot be analyzed under the FP approach, like aspectual auxiliaries. This is because default auxiliaries cannot be described as consistently associated with a specific functional head (the overflow pattern of auxiliary use). Instead, default auxiliaries will be analyzed according to the Insertion approach (chapter 4). I propose that auxiliary verbs are verbs of level 0, as shown in (87).

(87) Default auxiliary:

$$\left[ \begin{array}{l} \text{CAT: } \langle \text{V}, 0 \rangle \\ \text{Infl: } \text{—} \end{array} \right]$$

Given the provision that HoP-Merge applies to categories with numerical values  $>0$ , default auxiliaries do not participate in HoP-Merge (we will see in the next chapter that they can only be merged via c-selection; section 4.3.2). Additionally, default auxiliaries have an unvalued Infl-feature, like projecting verbs, but they do not select for lexical roots, or any other category.<sup>20</sup> The details of default auxiliary insertion will be presented in the next chapter, where I argue that they are expletive elements of the verbal category merged via last-resort selection.

Below is the proposed typology verbal elements. Lexical verbs are projecting due to their level feature 1 (88), while auxiliary verbs are non-projecting: either due to being of a higher, functional level, as in the case of aspectual auxiliaries like *lokhe* (89), or because of a zero level specification – default auxiliaries (90).

---

20. I leave open the possibility that *v* may not directly select for a lexical root, but rather for another functional head responsible for introducing argument structure, e.g. Appl. Default auxiliary verbs have no selectional features whatsoever.

(88) Lexical verb:

$$\begin{bmatrix} \text{CAT:} & \langle \text{V},1 \rangle \\ \text{SEL:} & \checkmark \\ \text{Infl:} & \text{—} \end{bmatrix}$$

(89) Aspectual auxiliary:

$$\begin{bmatrix} \text{CAT:} & \langle \text{V},3 \rangle \\ \text{Infl:} & \text{IMPF} \end{bmatrix}$$

(90) Default auxiliary:

$$\begin{bmatrix} \text{CAT:} & \langle \text{V},0 \rangle \\ \text{Infl:} & \text{—} \end{bmatrix}$$

### 3.5.2 *Auxiliaries are verbal in Ndebele*

Let me briefly consider an alternative view of auxiliaries, one which does not fall into any of the three approaches discussed here. Given the numerous differences between auxiliary and lexical verbs discussed here, one might hypothesize that they are, in fact, not verbs at all, i.e. have no features characteristic of verbs. As such, auxiliary verbs would essentially have the status of what we could call a *particle*, or perhaps just cluster of affixes without a verbal root. This view of auxiliaries has been proposed, for instance, for auxiliaries in Basque, where no clear verbal root can be identified in the auxiliary complex head (Arregi & Nevins, 2012). It is entirely possible that what we call an *auxiliary* refers to verbal elements in some languages and to non-verbal clusters of morphemes in others.<sup>21</sup> It has been, in fact, argued that the category of auxiliary verb, Aux, is not reserved for auxiliary verbs (Akmajian & Wasow, 1975; Akmajian et al., 1979; Steele et al., 1981), but may also host non-verbal elements expressing inflectional information such as tense and agreement (this was given as arguments for the Aux-hypothesis, whereby auxiliaries are not of the same category as verbs (Chomsky, 1957)). The very fact that in some languages the Aux category has been treated as verbal and in others as non-verbal suggests that verbal properties can be traced in auxiliary elements in some languages. I argue that Ndebele is such a language. Both default and aspectual auxiliaries have verbal properties.

---

21. In fact, this has been argued for Bantu languages: all verbal prefixes have been proposed to form a constituent and treated on a par with auxiliary verbs (Barrett-Keach, 1980, 1986; Myers, 1987, 1998). This hypothesis was, however, put forth for what I refer to simple tenses. In (Pietraszko, 2017a), I argue that the characterization of inflectional prefixes in Ndebele as an *auxiliary* is misleading and that they should not be treated a par with auxiliaries such as those used in compound tenses.

Let us consider first default auxiliaries. The main argument for their verbal category is the fact that they inflect for tense. In this, they behave like lexical verbs (91).

(91) Default auxiliaries are verbal: they host tense inflection

- |    |   |                     |
|----|---|---------------------|
| a. | Ngi-za-bala.<br>1sg-FUT-read<br>'I will read'                         | T+lexical verb      |
| b. | Ngi-za-be    ngi-bala.<br>1sg-FUT-AUX 1sg-read<br>'I will be reading' | T+default auxiliary |

In fact, under the last-resort view of default periphrasis discussed in the next chapter, the purpose, so to say, of their appearance is to support inflection (e.g. tense). Assuming that inflectional features must combine with verbs, it is their verbal category that causes default auxiliaries to be inserted.

The verbal nature of aspectual auxiliaries is perhaps more dubious than of default auxiliaries since they cannot bear tense inflection, as shown in (92).

(92) Aspectual auxiliaries cannot inflect for tense:

- |    |   |
|----|---|
| a. | *Ngi-za-lokhe ngi-bala.<br>1sg-FUT-still 1sg-read<br>(‘I will still be reading’)              |
| b. | *Ngi-za-hlezi        ngi-bala.<br>1sg-FUT-constantly 1sg-read<br>(‘I will constantly read’)   |
| c. | *Ngi-za-se        ngi-balile.<br>1sg-FUT-already 1sg-read.PST<br>(‘I will have already read’) |

Given this, the only way in which they resemble verbs is that they are preceded by a subject agreement prefix. Suppose that having a subject agreement prefix is not indicative of a verbal



category. If this is the case, we might hypothesize that *lokhe*, for instance is not a verb but a possible, non-verbal, realization of the head Asp with an imperfective feature, and bears no verbal category feature. In other words, it is essentially an agreeing affix. There are two reasons to think of *lokhe* as a verb rather than as an affix. I discuss them below.

In addition to *lokhe*, the adverbial meaning ‘still’ can be expressed by the prefix *sa-* (93).

- (93) a. Ngi-**lokhe** ngi-bala.  
 1sg-still 1sg-read  
 ‘I am still reading’
- b. Ngi-**sa**-bala.  
 1sg-still-read  
 ‘I am still reading’

I assume that the prefix *sa-* is an exponent of an Asp head with an imperfective feature, like *lokhe*. Thus, the basic syntax of the two sentences in (93) is the same (94)-(95). Nonetheless, when Asp is realized as *lokhe*, the main verb must have its own agreement prefix.

(94) *lokhe*: two AGR prefixes

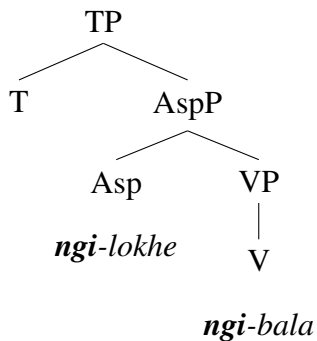

(95) *sa*: one AGR prefix

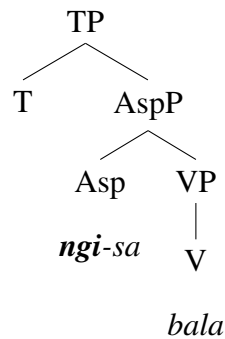

This argument is not based on whether the aspectual element has an agreement prefix – since both *sa* and *lokhe* are preceded by an agreement prefix, we may posit that an imperfective Asp heads has a phi-probe and that it will always surface with a subject prefix. The puzzling fact is the presence of an agreement on the main verb in (94). It is unclear why the main verb is inflected for subject agreement when Asp is realized as *lokhe*, but not when it’s realized as *sa*. Naturally,

the same question arises if we assume that *lokhe* is a verb. But at the very least, we can generalize that the number of agreement prefixes corresponds to the number of verbal elements in the entire expression. In chapter 6, I propose a formal implementation of this generalization. Crucially, not distinguishing between *sa* and *lokhe*, i.e. assuming that they are allomorphs, leaves us with no syntactic correlate of the distribution of agreement prefixes.

Another difference between *lokhe* and *sa* is negation marking. As discussed in section (30), *lokhe* cannot be morphologically negated. Instead, negation surfaces low, on the main verb (96). In contrast, the expression with *sa* can (97).

(96) a. \***A**-ngi-lokhe ngi-bala.  
 NEG-1sg-still 1sg-read  
 (I am still not reading/not reading anymore)

b. Ngi-lokhe ngi-**nga**-bali.  
 1sg-still 1sg-NEG-read  
 I am still not reading

(97) **A**-ngi-sa-bali.  
 NEG-1sg-still-read  
 I am not reading anymore

I proposed that the impossibility of the high negation marker *a-* is due to constraints on movement of the negation clitic from NegP to  $\Sigma$ P. Assuming that each element of a verbal category introduces a phase boundary, this movement is impossible in aspectual-verb constructions since they involve a verbal element intervening between NegP and  $\Sigma$ P, as shown again in (98).

(98) No Neg-clitic movement across an aspectual auxiliary:

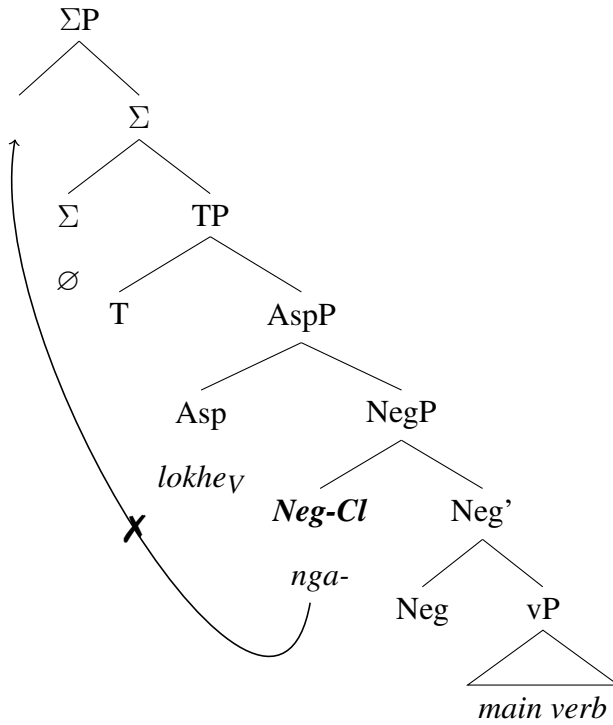

If the difference between *sa* and *lokhe* is that only the latter is of a verbal category, we can account for the lack of blocking of Neg-clitic movement with *sa*, correctly deriving high negation on forms with *sa*, in an otherwise identical structure (99).

(99) Neg-clitic movement across the prefix *sa*:

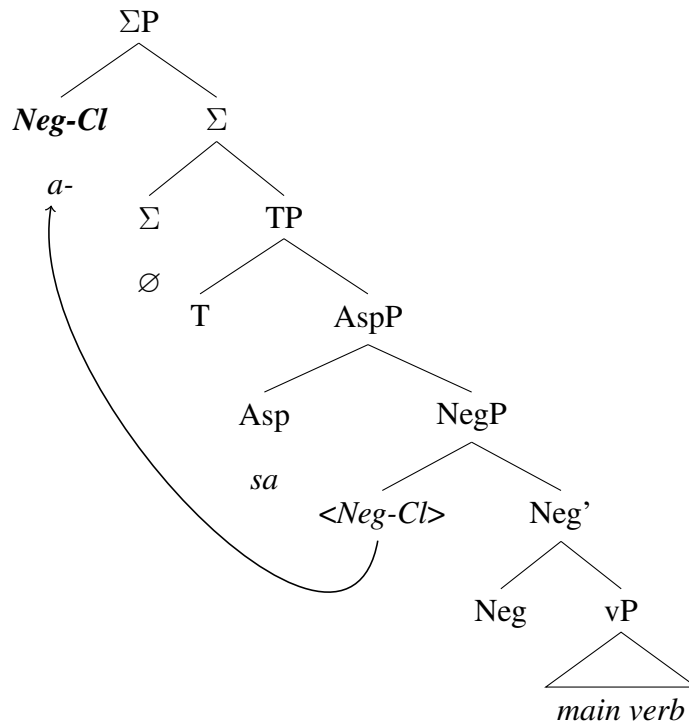

In sum, treating aspectual auxiliaries as non-verbal, i.e. on a par with affixes, poses additional problems. On the other hand, the asymmetries between aspectual affixes and aspectual verbs can be captured by a category difference between them. I conclude, therefore, that both default and aspectual auxiliaries do have a verbal category feature, even though they are verbs of a different kind than main, projecting verbs.

### 3.6 Conclusion

In this chapter, I contrasted two types of approaches to auxiliary verbs: the VP approach, in which auxiliaries are verbs projecting a VP, and non-projection approaches (the FP approach and the Insertion approach). I argued that the VP approach faces multiple problems which do not arise under the non-projection approaches: the limited projection problem, the selection problem and the overflow problem. We have also seen that both the FP approach and the Insertion approach are necessary, though for different types of auxiliaries. Aspectual auxiliaries in Ndebele are best un-

derstood as *functional verbs*, verbal elements base generated in specific functional heads. Unlike the VP approach, the proposed FP approach to aspectual auxiliaries makes a range of correct predictions about selectional patterns and cooccurrence restrictions in aspectual-verb constructions. On the other hand, the distribution of default auxiliaries in Ndebele has a last resort profile, supporting the Insertion approach to default periphrasis (developed in detail in chapter 4). I conclude, therefore, that the VP approach finds no empirical support in Ndebele, a language with a variety of multi-verb constructions. In chapter 5, I will discuss a third type of multi-verb construction, where the light verb is indeed a lexical verb projecting a VP. I argue, however, that it behaves exactly as predicted from lexical verbs (e.g. the limited-projection problem does not arise), and should therefore be treated on a par with lexical, not auxiliary verbs.

## CHAPTER 4

### DEFAULT PERIPHRAISIS AND THE INSERTION APPROACH

#### 4.1 Introduction

I argued in the previous chapter that auxiliaries in Ndebele are non-projecting verbs – a property that sets them apart from regular lexical verbs which can project full clausal structure. I also pointed out a division within the class non-projection approaches and argued that aspectual auxiliaries are better characterized as functional verbs (the FP approach), while default auxiliaries as last resort verbs (the Insertion approach). In this chapter, I develop an insertion account of default periphrasis in Ndebele. In section 4.2 I lay out the main issues of default periphrasis seen as a repair strategy and identify the types of questions an analysis in this vein must address: the Failure Question, which concerns the triggers of auxiliary insertion, and the Repair Question – a question about the nature of auxiliary insertion itself. The proposed mechanism of auxiliary insertion is designed to achieve the following objective: to understand auxiliary insertion in terms of a general grammatical mechanism combining verbs with inflections. Following Cowper (2010), I propose that his mechanism is c-selection, which I model here as Cyclic Selection – an implementation of selection allowing for a last-resort checking of selectional features (section 4.3.1). I propose that the non-projecting property of default auxiliary verbs is due to their expletive nature: they are minimal verbs, with a category level 0, and able to enter the derivation only when selected for via a last-resort V-selection by an inflectional head (section 4.3.2). In section 4.3.3 I discuss the advantages of the proposed approach to auxiliary insertion (the Repair Question) over existing alternatives. Further, I address the Failure Question in section 4.4. I demonstrate how the proposed system of c-selection interacts with Infl-agreement to trigger auxiliary insertion and derive the overflow pattern of auxiliary use in Ndebele, focusing first on imperfective tenses 4.4.1, and then extending the analysis to other compound tenses in Ndebele, perfect and prospective tenses, which, as I argue, involve a lower tense projection 4.4.2. Finally, in section 4.5, I discuss the rela-

tionship between auxiliary insertion and head movement of the verb. Contra existing approaches, I argue that head movement does not regulate periphrasis and that the only relationship between the head movement and aux-insertion is a complementarity, which falls out from the proposed system.

## 4.2 Default periphrasis as a repair strategy

In chapter 3, I presented one piece of evidence for the Insertion approach to default periphrasis, namely the overflow pattern of auxiliary use. As argued extensively by Bjorkman (2011), this pattern is incompatible with any approach to periphrasis in which auxiliary verbs are base generated (the VP approach and the FP approach). In this section, I discuss the motivation for an insertion approach in some more detail. In subsection 4.2.1, I present several aspects of default periphrasis which provide a rationale for the Insertion approach to auxiliary verbs. I then go on to discuss the nature of default periphrasis as a last resort phenomenon, treated under the Insertion approach as a repair strategy (subsection 4.2.2). I briefly review existing accounts in this spirit and identify the two main questions that any analysis of default periphrasis as a repair strategy should address: the Failure Question (concerning the triggers of auxiliary insertion) and the Repair Question (concerning the nature of the insertion itself).

### 4.2.1 *Main arguments for the insertion approach*

The four features of default periphrasis that support the insertion approach are listed in (1).

- (1) Characteristic features of default periphrasis
  - (i) sensitivity to inflectional complexity
  - (ii) the last resort nature
  - (iii) semantic vacuity of default auxiliaries
  - (iv) the overflow pattern of auxiliary use

The distribution of compound tenses is not arbitrary cross-linguistically: present tenses are typically synthetic, but Past Perfect, for instance, tends to require an auxiliary. This **sensitivity to inflectional complexity** is illustrated below for English (2) and Ndebele (3).

- |     |  |                                   |
|-----|--|-----------------------------------|
| (2) | a. John cooked.  | <i>Simple Past; synthetic</i>     |
|     | b. John had cooked.  | <i>Past Perfect; periphrastic</i> |
| (3) | a. UZodwa u-∅-phek-ile.<br>1Zodwa 1s-PST-cook-FS.PST<br>'Zodwa cooked.'                | <i>Simple Past; synthetic</i>     |
|     | b. UZodwa u-∅-ye e-phek-ile.<br>1Zodwa 1s-PST-AUX 1s-cook-FS.PST<br>'Zodwa had cooked' | <i>Past Perfect; periphrastic</i> |

The various accounts of such tendencies offered in the literature share the general insight that periphrasis occurs with an increased amount of functional information, e.g. when both past tense and perfect aspect are to be expressed. If we think of functional information as morphosyntactic features on functional heads, we can generalize that *periphrasis is triggered by increased complexity of the functional syntactic structure*. This generalization is robust. While languages differ in the amount of periphrasis and synthesis, there appear to be no languages in which the opposite generalization holds, i.e. languages in which simple past, for instance, is periphrastic but the expression of past tense and perfect aspect together is synthetic (Dahl, 1985; Bybee & Dahl, 1989; Bybee et al., 1994; Haspelmath, 2000).

There is convincing evidence that, unlike lexical verbs, default auxiliaries, such as the English *be*, do not contribute to the semantics of the predicate (Chomsky (1993); Rothstein (1999, 2004); Iatridou et al. (2003); Pancheva (2003); Embick (2004), among others). For instance, auxiliary verbs do not seem to have their own thematic structure. Rather, all arguments that occur in a clause with an auxiliary verb are arguments of the main, lexical verb. Given the apparent **semantic vacuity of default auxiliaries**, it is a common claim that their occurrence is triggered by formal



constraints of the grammar, it is a way of satisfying some grammatical requirement. In this sense, auxiliaries can be thought of as playing a similar role to the English preposition *of* in nominalizations. A nominalized transitive verb cannot select a direct object (for case-licensing reasons, in the standard view (Chomsky, 1980)), and the preposition *of* must be used to satisfy that condition. Importantly, the preposition does not seem to have any other contribution beside introducing an argument DP. Another, and perhaps a better analogy is with expletive subjects. They do not introduce thematic subjects (they can appear in addition to them) and their only trigger is a requirement that an element of the nominal category is merged the Spec,TP position. Similarly, the default auxiliary has no semantic contribution, and can be thought of satisfying a grammatical constraint. This is the basic idea behind the insertion approach: periphrasis is viewed as a repair strategy, whereby an auxiliary verb is inserted in the derivation only when it serves to satisfy some grammatical constraint. But what is this grammatical constraint? This question is not always addressed explicitly in the literature, but the general assumption seems to be that auxiliary insertion is driven by the requirement that a verbal inflection be realized on (or otherwise combine with) a verb. Periphrasis arises only in case some inflectional category fails to do so.

Additionally, the distribution of auxiliaries in compound tenses has a **last-resort nature**: auxiliary verbs do not appear unless necessary. That is, an auxiliary verb is used *always* and *only* when an inflectional feature cannot combine with the main verb. As an illustration, consider the contrast between the English simple present (4) and present progressive (5).

- |  |                                    |
|--|------------------------------------|
| (4) <i>Auxiliary 'be' not required</i> | (5) <i>Auxiliary 'be' required</i> |
| a. John work-s. ✓                      | a. *John working-s.                |
| b. *John is work.                      | b. John is working. ✓              |

Both sentences in (4) are intended to encode the same meaning. From the grammatical (4-a) we see that the 3rd person present tense suffix *-s* can combine with the verb '*work*' to form a synthetic expression. The last-resort profile of periphrasis in (4) is evident from the ungrammaticality of

(4-b): since the auxiliary is not necessary, it is not allowed. In the progressive tense (5), on the other hand, the verb takes a special form – the *ing*-participle. As (5-a) shows, the participial form resists combining with the suffix *-s*. As a last resort way of expressing that feature, the auxiliary *be* must be inserted and support the realization of *-s*.

It is worth noting that the three properties of default periphrasis discussed above (sensitivity to inflectional complexity, the last-resort nature, and the semantic vacuity of default auxiliaries) are not incompatible with non-insertion approaches. First, neither the VP and FP approach make any predictions about the auxiliary's semantic content and, in fact, must posit semantic vacuity or deficiency of default auxiliary verbs. And second, neither the last-resort nature nor sensitivity to complexity are properties which require an analysis of default periphrasis as arising via a last-resort derivational *mechanism*. Indeed, none of the two non-insertion approaches involves such a mechanism. They both assume that auxiliary verbs are base-generated (as verbs or functional heads) and systematically occur in particular inflectional contexts. Unlike in the insertion approach, the appearance of an auxiliary verb is not derivationally determined. Crucially, however, the last-resort nature of default periphrasis and its sensitivity to inflectional complexity come out as accidental under the base-generation approaches. Take the FP approach as an illustration. The reason why simple past is synthetic while past progressive is periphrastic is not due to increased inflectional complexity (past tense and progressive aspect cooccurring), but due to the property of the progressive Asp head in English as being realized as the auxiliary *be*. Similarly under the VP approach, the reason past progressive is periphrastic is because progressive participles must be selected by a semantically empty V (the auxiliary), not because of increased inflectional complexity. The insertion-approach, on the other hand, attempts to derive these properties. Treating auxiliary insertion as a repair strategy accounts for its last resort nature. And treating the disproportion between inflections and verbs as a trigger of such a repair captures the sensitivity of periphrasis to inflectional complexity.

Finally, the existence of **the overflow pattern** of auxiliary use in compound tenses is an impor-

tant empirical argument for the treatment of default periphrasis as a repair strategy. As discussed in the previous chapter, in languages with the overflow pattern, auxiliaries cannot be characterized as being a property of a particular inflectional category, which poses a serious problem for both base-generation approaches, as argued by Bjorkman (2011). Recall the overflow pattern of the future and progressive inflections in Ndebele in (6).

(6) The overflow pattern in Ndebele

- |    |   |                            |
|----|---|----------------------------|
| a. | U- bala ibhuku.<br>2sg.s- read 5book<br>'You are reading a book'                | <i>Present Progressive</i> |
| b. | U- za- bala.<br>2sg.s- FUT- read<br>'You will read'                             | <i>Simple Future</i>       |
| c. | U- za- <b>be</b> u-bala.<br>2sg.s- FUT- AUX 2sg.s-read<br>'You will be reading' | <i>Future Progressive</i>  |

As we see in (6-a) and (6-b), neither future tense nor progressive aspect require an auxiliary verb. If we treat auxiliary verbs as properties of certain inflectional heads, we would predict that the Future Progressive tense should be synthetic since neither of the inflectional categories it contains is associated with an auxiliary. If, on the other hand, auxiliaries are the result of derivational insertion, their appearance may be determined dynamically, during the derivation, by a mechanism sensitive inflectional complexity.

#### 4.2.2 *The failure and the repair*

An analysis of default periphrasis as a repair strategy must address two issues. First, it has to identify the failure or violation that triggers a repair. And second, it should offer an understanding of the repair strategy itself. Following the widely shared intuition about the trigger of periphrasis, I assume that, in general terms, the failure has to do with an inflection not being able to combine

with a verb. The specific questions we must ask, then, is exactly what aspects of the grammar determine when an inflection can and cannot combine with a verb. I will refer to this as the *Failure Question*. Whatever the nature of the failure, we additionally need to understand why this failure is repaired the way it is, namely by an insertion of a verb. I call this the *Repair Question*.

**The Failure Question:** What specific aspects of the grammar determine when an inflection fails to combine with the main verb (to form a synthetic expression)?

**The Repair Question:** Why is this failure repaired by inserting an auxiliary verb?

Recent accounts of periphrasis offer different answers to these questions. Existing approaches to the Failure Question come in two types: one in which the failure is defined in configurational terms (the verb and the inflection must be in a particular syntactic configuration) and the other in which the failure is understood as a type of feature conflict. As far as the configurational approach to the Failure Question, it has been proposed that it has to do with the lack of head movement of a verb to an inflectional head (Arregi (2000) for Basque, Embick (2000) for Latin). Under this view, synthesis of the verb with an inflection hosted in F is the result of V-to-F movement. In the absence of such movement, F is supported by an auxiliary verb. In Bjorkman (2011), the violation is also defined configurationally: an uninterpretable Infl feature (uInfl) must appear in a complex head that also contains a verb. A uInfl which is not in a complex head with a verbal element is morphologically ill-formed and triggers postsyntactic insertion of a V in that head. Since the constraint is to have a V in the same complex head, head movement is an important factor regulating periphrasis in Bjorkman's analysis as well. Another view, put forth in Cowper (2010), Arregi & Klecha (2015) and my earlier work (Pietraszko, 2016), treats the failure of synthesis as a result of feature conflict. Generally speaking, an inflectional category, e.g. past tense, cannot combine with the main verb if the verb already has an inflectional feature (e.g. imperfective aspect). The answer I give to the Failure Question is of the latter type: an inflection can combine with the verb as long as the verb has not already combined with another inflectional feature by Infl-

agreement. In section 4.4 I present the exact mechanism that derives this effect, and in section 4.5 I provide theoretical and empirical arguments supporting the view that the triggers of periphrasis are better understood in terms of feature conflict than in terms of specific syntactic configurations.

The Repair Question concerns the particular repair strategy involved in periphrasis, i.e. auxiliary insertion. Assuming that the failure has to do with an inflection not being able to combine with a verb, the nature of this repair seems very natural: the repair is verb-insertion because the violation was related to a lack of a verb (7).

(7) The relation between the failure and the repair

Failure:		Repair:
inability of INFL to combine with a verb	⇒	verb insertion in INFL

While the relation between failure and repair represented in (7) seems natural, it is important that the arrow in (7) does not only represent our intuitions. In an explanatory theory of verbal periphrasis, the relation between failure and repair falls out from the system. With this in mind, we must identify the triggers of synthesis (i.e. the mechanism(s) combining verbs and inflections in simple, non-periphrastic expressions), and try to understand auxiliary insertion as caused by the same triggers. Following Cowper, I argue that the trigger is c-selection. That is, c-selection is the relation between verbs and inflections that underlies both synthesis and periphrasis. In synthesis, c-selection is satisfied by the main verb. In periphrasis, the c-selectional feature is checked by an auxiliary verb. I discuss the details of this analysis in section 4.3, pointing out the modifications of Cowper's original account. I also discuss alternative answers to the Repair Question, and demonstrate why they do not offer an explanatory account of the relation in between failure and repair.

### 4.3 The Repair Question: Auxiliary insertion as selection-triggered Merge

This section is devoted to answering the Repair Question, concerning the nature of auxiliary insertion. The goal is not only to provide a formal analysis of the process of auxiliary insertion but, more importantly, to identify a connection between auxiliary insertion and the mechanism(s) combining inflections and verbs in general. The objective is to arrive at an analysis of auxiliary insertion in which the relation between a verb and inflection is of the same nature in synthesis and periphrasis. Building on previous work (Cowper, 2010; Pietraszko, 2016), I propose that the relation in question is c-selection. I define the notion of Cyclic Selection, whereby the selectional V-feature on an inflectional head can be satisfied in two ways: by establishing a relation with the main verb (synthesis) or by triggering merge of the selected category, namely V (periphrasis). I develop the details of the Cyclic Selection system in subsection 4.3.1 and apply it to V-selection in subsection 4.3.2, pointing out a parallelism between auxiliary verbs and nominal expletives. Finally, in subsection 4.3.3 I return to the objective set up here, and discuss the advantages of the proposed analysis over existing alternatives in this respect.

#### 4.3.1 *Cyclic Selection in a functional hierarchy*

I adopt an implementation of c-selection as feature checking (Svenonius, 1994; Adger, 2003; Holmberg, 2000; Julien, 2002; Adger, 2010; Adger & Svenonius, 2011; Cowper, 2010, a.o.). A selectional feature has the form [SEL:X], while the matching category feature has the form [CAT:⟨X,n⟩], as shown in (8). The [SEL:X] feature is checked at Merge by a matching [CAT:⟨X,n⟩] feature. The strikethrough in (8) indicates that the selectional feature has been matched by a category feature and is now inactive.

(8) C-selection as feature checking

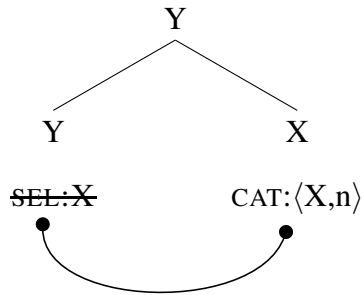

Further, I assume that c-selection triggers merge (in principle, both external and internal (Svenonius, 1994; Holmberg, 2000; Julien, 2002; Matushansky, 2006)<sup>1</sup>). Thus, the merge of Y and X in (8) is triggered by the SEL feature on Y, matched and checked by the CAT feature on X.<sup>2</sup> Given the tight connection between c-selection and merge, category checking typically obtains under strict locality – under sisterhood, as in (8). Note, however, that this formalization of c-selection as feature checking does not pose this strict sisterhood requirement. Rather, it allows c-selection to take place at a distance. This view of c-selection is adopted by Cowper (2010) in her analysis of English auxiliaries, but it should be noted that it is not only motivated by periphrasis. It has been argued by Svenonius (1994), Shlonsky (2006) and Merchant (2016) that c-selection has non-local instances, where the head imposing selectional restrictions is separated from the selectee by other material. Implementing c-selection as feature checking allows for an account for such cases of long-distance selection.

A less obvious property of c-selection is that it is the only operation that triggers Merge. This claim has been challenged by Abney (1987), who argues that c-selection is only responsible for those instances of structure building that show some level of idiosyncrasy. For instance, certain verbs select for particular prepositions or particular clause types. It is well known, that such idiosyncrasy is not a property of every level of the syntactic structure. Functional categories, such

---

1. See section 4.5.2 for a discussion of selectional features triggering internal merge.

2. Explicit definitions of selection as an operation underlying structure building can be found e.g. in Adger (2010) or Merchant (2016).

as Tense, Aspect, Mood, Negation, tend to come in a fixed order cross-linguistically. Based on the insights about categories and extended projections (Abney, 1987; Grimshaw, 1991, 2000), it has been proposed that functional categories are organized around lexical categories such as V or N, and come in a universally fixed order, forming what we call Functional Hierarchies (Cinque, 1999) or Hierarchies of Projections (Adger & Svenonius, 2011). Adger (2010) proposes that such universal hierarchies are not built by c-selection-triggered Merge. As discussed in the previous chapter, Hierarchies of Projections (HoPs) are the result of a different type of structure building: they are pre-defined and immune to c-selection. Adger defines two types of Merge operation (or one but which is sensitive to the syntactic objects that are merged, in particular whether they belong to a Hierarchy of Projections or not): one triggered by c-selection (9-a), and the other determined by a Hierarchy of Projections (9-b).

(9) Two types of structure building (Adger, 2010)

- a. *Sel-Merge*: c-selection-triggered Merge (subcategorization)
- b. *HoP-Merge*: structure building is determined by a fixed order of functional projections

Since *Sel-Merge* builds structures on the basis of c-selectional properties of merged objects, the structure we saw in (8) is built by *Sel-Merge*. This is the type of structure building that is sometimes referred to as subcategorization, and one that has the potential to encode idiosyncratic relations between the selector and the selectee. The other type of structure building, *HoP-Merge*, is responsible for creating functional hierarchies, which are universal and are not subject to c-selectional properties of heads, but to a universal ordering of functional categories. Recall from chapter 3 that the value of a category feature is an ordered paired of a category label and a natural number. *HoP-Merge* takes a category list, such as the one in (10), and returns a structure with the categories organized hierarchically according to the pre-defined ordering (11). Crucially, c-selection is not involved in building the structure in (11).



(10)  $\langle W, 1 \rangle, \langle X, 2 \rangle, \langle Y, 3 \rangle, \langle Z, 4 \rangle$

(11) *HoP-Merge*

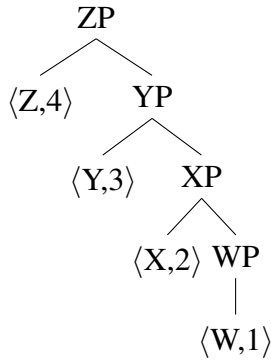

Turning to c-selection, the standard assumption is that it must be satisfied at merge, i.e. under sisterhood. However, this does not take into consideration the possibility of other types of structure building, such as HoP-Merge which forms functional hierarchies and does not rely on c-selection. Rather, the "c-selection under sisterhood" requirement falls out from a theory in which *all* structure building is triggered by c-selection. Adopting the opposite view, as I do here, the question arises of what happens when a sisterhood relation is formed by HoP Merge, not by Sel-Merge, while at the same time one of the sister nodes has a c-selecting feature. This is a situation where a c-selecting head is also a head belonging to a functional hierarchy. This is illustrated in (12), where the head Y, the second head in the hierarchy, has a c-selecting feature.

(12) A functional hierarchy with a c-selecting head

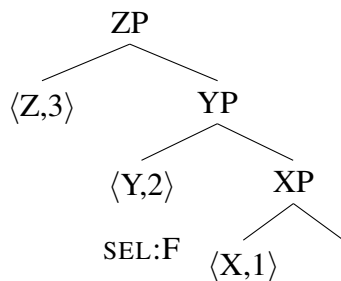

I follow Adger (2010) and Adger & Svenonius (2011) in that functional hierarchies are pre-

determined – there can be nothing in the head-complement sequence that does not belong to the hierarchy. For instance, if the hierarchy is defined as in (13-a), the structure in (13-b) can never be built. Even though Y, belonging to the hierarchy, c-selects for F,  $\langle Y,2 \rangle$  must be projected directly from  $\langle X,1 \rangle$  according to the Hierarchy of Projections.

- (13) a.  $\langle X,1 \rangle < \langle Y,2 \rangle < \langle Z,3 \rangle$   
 b. Impossible structure: Sel-Merge interfering with a Hierarchy of Projections

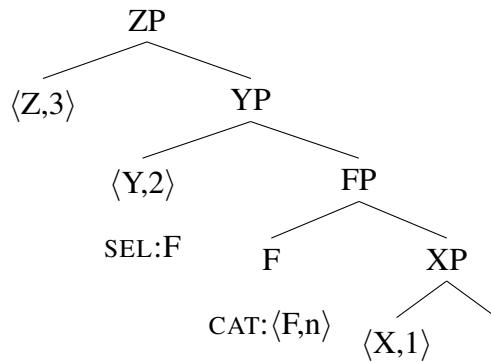

In other words, all head-complement relations in a functional hierarchy must reflect the ordering specified in the hierarchy.

What happens with the c-selectional feature then? I propose that two ways of checking it are available: the category feature may be checked at a distance, i.e. with a lower element of a matching category<sup>3</sup> (as argued by Cowper (2010)) or the c-selectional feature may trigger Sel-Merge of a specifier (following Adger (2010); Adger & Svenonius (2011) who note that the only instance of Sel-Merge in an HoP may maybe a merge of a specifier).

- (14) Two ways of checking c-selectional features in a Hierarchy of Projections.  
 a. Checking at a distance (with a lower matching goal)  
 b. Triggering Sel-Merge (of a specifier)

---

3. Local checking with a c-commanded category, i.e. with a complement, is also possible, as long as the complement does not disrupt the functional hierarchy.

The first scenario is illustrated in (15), which is a well-formed counterpart of (13-b). The hierarchy is the same ( $X < Y < Z$ ), the second head, Y, has a selectional feature requiring a matching category F, and F is not part of the HoP. Unlike in (13-b), F in (15) does not interfere with the head-complement sequence determined by the hierarchy and so the structure like (15) is well-formed. In this configuration, SEL:F on Y is checked by F at a distance.

(15) Checking of a c-selectional feature at a distance

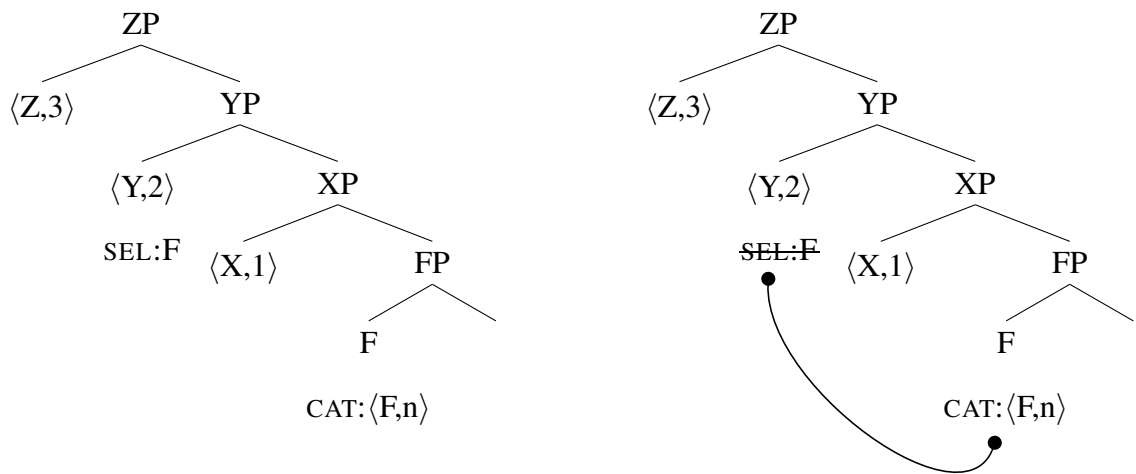

I assume that feature checking takes place as soon as the checking probe enters the derivation. In (15), it can apply the moment Y becomes part of the structure because, at that point, a matching category is available. It is only when no matching goal is available that a selectional feature triggers Sel-Merge. In this sense, Sel-Merge in a Hierarchy of Projections has a last resort profile. This scenario is schematized in (16). When Y is merged, there is no matching goal in the structure to check SEL:F on Y. As a result, the selectional feature is still active and triggers Sel-Merge of a specifier. The newly merged category then checks the SEL:F on Y, and the selectional feature becomes inactive.

(16) a. No matching goal: [SEL:F] unchecked

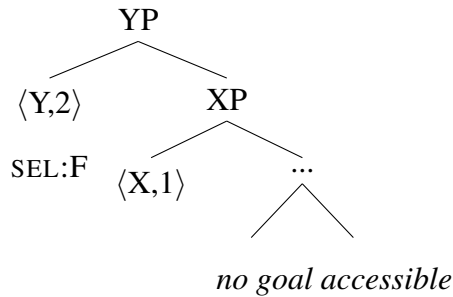

b. Unchecked [SEL:F] triggers Sel-Merge

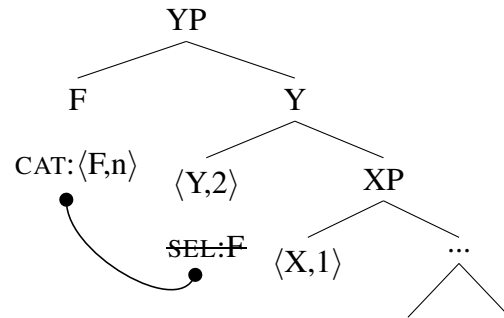

Finally, let us address the question of directionality of the checking operation. The mechanism of c-selection proposed above requires that feature checking be able to obtain under two different configurations: downward checking (by searching its c-command domain) and upward checking (with the newly merged specifier). There has been some recent discussion concerning directionality of a different operation, namely Agree. Initial formulations of Agree (Chomsky, 2000, 2001) allow only downward agreement, where the probe can only agree with a goal that it c-commands. The opposite was proposed for instance by Zeijlstra (2012), Merchant (2011), Wurmbrand (2011) and Bjorkman & Zeijlstra (2014). These authors argue that *Upward Agree/Reverse Agree* (agreement with a c-commanding goal) is either equally allowed as *Downward Agree* or even preferred. However, it was argued by Preminger & Polinsky (2015) that, at least in the domain  $\varphi$ -agreement, the upward directionality can be dispensed with, while *Downward Agree* is indispensable. Finally, directionality of the Agree operation has been argued to be in principle unrestricted but be subject to cyclicity. This view of Agree was proposed by Béjar & Rezac (2009) and is known as *Cyclic Agree*. The idea behind *Cyclic Agree* is that the probe must search for a matching goal as soon as possible, that is, as soon as it becomes part of the derivation. Given that at the point when the probe is merged it is the highest element in the structure, it can only search downwards. Consequently, the only way for the probe to be valued by a goal yet to be merged is when the probe does not find a goal in its c-command domain. This is exactly the way selectional checking behaves in the

system proposed here. Its directionality is not restricted to upward or downward, but downward checking is the default scenario – given cyclic application of operations, it will always be the first attempt. I refer to this mechanism of c-selection as **Cyclic Selection** (89-c).

- (17) *Cyclic Selection*: SEL searches its c-command domain for a matching CAT
- a. Successful search: SEL is checked and becomes inactive
  - b. Unsuccessful search: SEL triggers Sel-Merge of a matching CAT, which in turn checks SEL in a Spec–head configuration.

Crucially, Cyclic Selection renders Sel-Merge the last-resort way of satisfying a selectional feature. This aspect of Cyclic Selection is important in the next section, where I apply this mechanism to verb selection and argue that auxiliary insertion is an instance of Sel-Merge in a Hierarchy of Projections, capturing the last-resort profile of default periphrasis.

#### 4.3.2 *Auxiliary insertion as the result of Cyclic Selection*

I propose that functional heads in the verb’s extended projection have a selectional SEL:V, i.e. a selectional feature which must be checked by a verbal category (following Julien (2002) and Cowper (2010)).<sup>4</sup> This is true of all heads with the exception of little *v*, which I treat as the category-introducing head. As such, *v* has a CAT:⟨V,1⟩ feature<sup>5</sup>. In the tree representations, I often omit the level value of the verb’s category feature, and simplify it to CAT:V, unless the values are relevant in the discussion. I refer to functional heads with a SEL:V feature as *inflectional heads*, and to c-selection for the verbal category as **V-checking**. V-checking in the verbal extended projection is illustrated in (18).

---

4. To be precise, Cowper’s systems is a bit more complicated: some functional heads have Sel:V (in Cowper’s formalism: *uV*) – a feature that must be checked by the main verb, and some have a *uv*, which in turn can only be checked by little *v*. This complication is not necessary in the account I develop.

5. Recall that the complement of *v* is taken to be an acategorial lexical root, though it is notated it as *V*, and therefore has neither a SEL:V nor CAT:V.

(18) **V-checking** (c-selection for CAT:V):

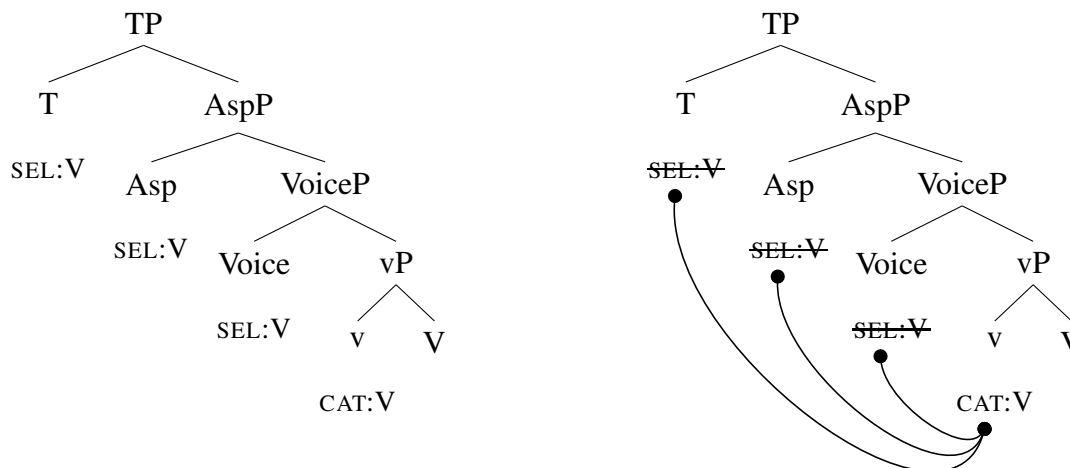

Recall that a verb's extended projection is a Hierarchy of Projections and so it is built by HoP-Merge. This means that the merge of T and Asp, for instance, is not driven by c-selection, and therefore any selectional features on these heads must be checked after the heads are merged in the structure. Assuming the Cyclic Selection account proposed in the previous section, all inflectional heads (Voice, Asp and T in (18)) attempt to check their [SEL:V] feature as soon as they enter the derivation. Given that the derivation contains a matching goal, Voice, Asp and T can all check their SEL:V feature against v, as shown in (18).

A derivation in which all inflectional heads check their [SEL:V] feature against the main verb (i.e. the little v in the main verb's projection) gives rise to a synthetic expression, one without an auxiliary verb. Periphrasis is observed when that is not the case. Suppose that the main verb is not accessible to the highest inflectional head, T (the nature of the inaccessibility will be discussed shortly). If T cannot reach the main verb, its [SEL:V] feature remains active and will trigger Sel-Merge of a verbal category (19). The newly merged verbal category is the auxiliary verb.

(19) Main verb inaccessible to T  $\Rightarrow$  Sel-Merge

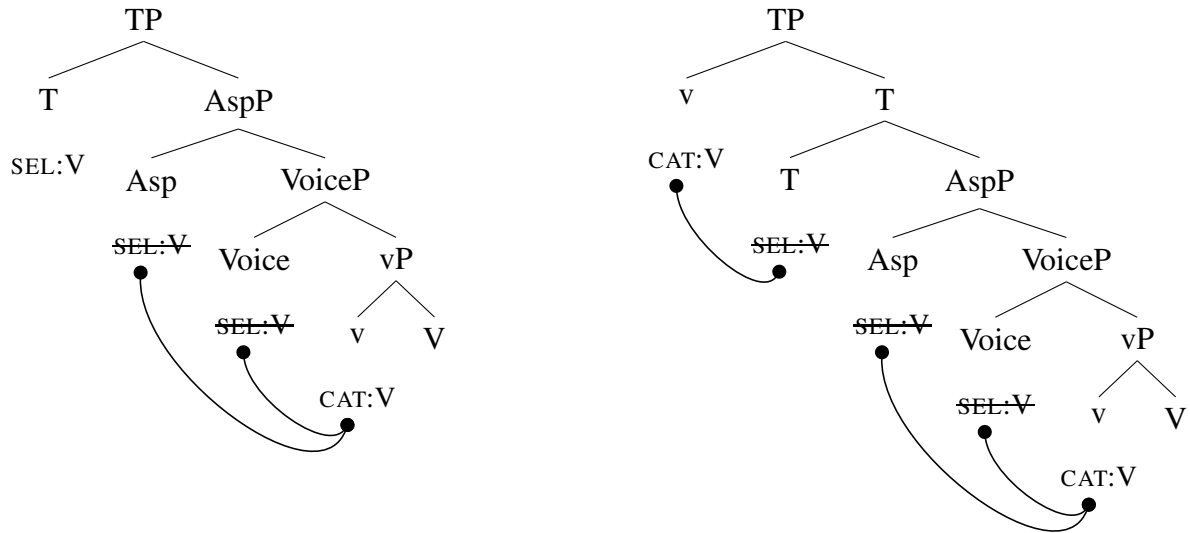

Under this approach, periphrasis is the result of the last-resort way of satisfying c-selectional features in the verbal functional hierarchy – Sel-Merge. Therefore, treating auxiliary insertion as the result of Cyclic Selection equips us with a mechanism that can account for the last-resort nature of default periphrasis. The proposal is summarized in (20). Synthesis is the outcome of successful V-checking within the existing structure (21). Periphrasis arises when the main verb’s category is inaccessible for checking and the selectional feature triggers Sel-Merge of a default verb (22).

(20) **Proposal:** Synthesis and periphrasis arise due to Cyclic Selection

- a. Synthesis: SEL:V checked by the main verb (default option)
- b. Periphrasis: SEL:V triggering Sel-Merge (last-resort option)

(21) V-checking by main verb

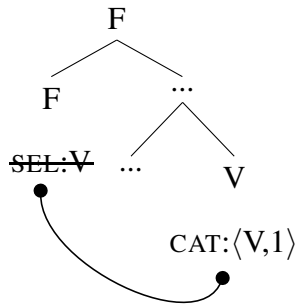

*synthesis*

(22) Sel-Merge of an auxiliary

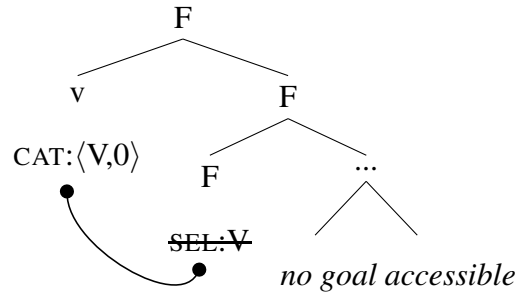

*periphrasis*

Assuming cyclicity of syntactic operations, c-selection satisfied by downward probing will always apply first, and if successful, will bleed merge of the selected category. For this reason, as long as a  $CAT:V$  goal is available when the selector is merged, c-selection will not trigger Sel-Merge, deriving the last-resort profile of auxiliary distribution.

The newly merged verb is the most unmarked element of the verbal category: it has no selectional feature and the level value 0. It has all and only the features needed to satisfy the selector's needs: a category V-feature and an unvalued Infl-feature (23-a) (the role of the unvalued Infl-feature on the auxiliary will be discussed in the next section). In this respect, it can be characterized an *expletive verb*, similar to expletives in the nominal domain. As proposed in the previous chapter, default auxiliaries have an unvalued Infl-feature and their category is verbal with no level value (23-a). I suggest that the lexical entry for its nominal counterpart may look like that in (23-b), though I do not take up the issue of nominal expletives further.



(23) *Expletive*: the most minimal lexical item of its category

a. Verbal expletive (default auxiliary):

$$\left[ \begin{array}{l} \text{CAT: } \langle V,0 \rangle \\ \text{Infl: } \text{—} \end{array} \right]$$

b. Nominal expletive:

$$\left[ \begin{array}{l} \text{CAT: } \langle D,0 \rangle \\ \text{Case: } \text{—} \end{array} \right]$$

I propose that last-resort selection can only access expletives – the most minimal elements of their category (24).

(24) *Condition on last-resort selection*

A selectional feature not discharged immediately at merge may only access expletives (minimal members of their category).

Given this parallel between the nominal and verbal domain, auxiliary insertion is essentially the same grammatical phenomenon as the insertion of expletive subjects (an analogy also made by Benmamoun (2000)). Nominal expletives are merged in Spec,TP to satisfy T's EPP (or  $uD/[SEL:D]$ ) feature. Assuming that c-selectional features trigger both external and internal merge, the EPP feature on T is really a selectional D-feature which may be satisfied either by movement or by merge of an expletive, as schematized in (25) and (26) respectively. Note that the relevant case of D-checking must culminate in merging an element of category D in Spec,TP, whether checking is done by the full DP subject (25) or by an expletive (26). In other words, what we call an EPP feature is a strong selectional D-feature (marked with an asterisk in (25) and (26)), which requires merge, internal (25) or external (26).

(25) D-checking by a full DP subject

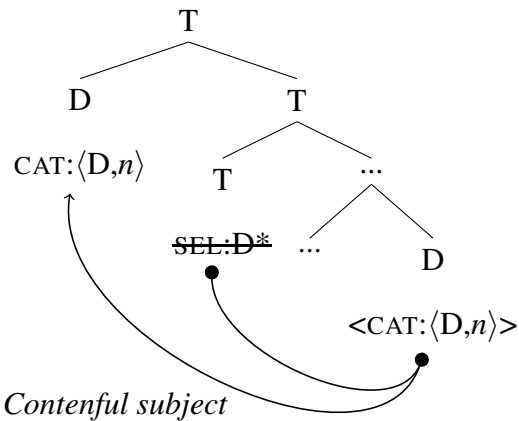

(26) Sel-Merge of an expletive subject

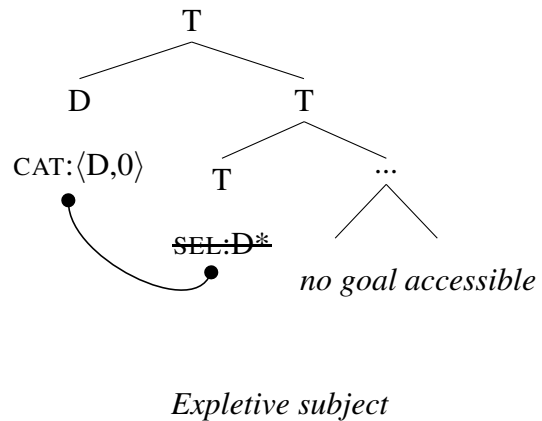

The selectional V-feature may also be strong, in which case it would trigger head movement of the verb to the relevant functional head. I discuss the relationship between auxiliary insertion and head-movement in section 4.5.2.

Finally, I propose that after Sel-Merge, the auxiliary undergoes m-merger with T (Matushansky, 2006). As shown in (27), the auxiliary verb in Ndebele is linearized to the right of the tense marker. I assume that this stems from the morphological property of T as being a prefix, and represent it as right adjunction of the auxiliary V to T after m-merger.

(27) a. U-za-be e-bala  
 1s-FUT-AUX 1-read.PTCP  
 'He will be reading'

b. M-merger of aux V and T:

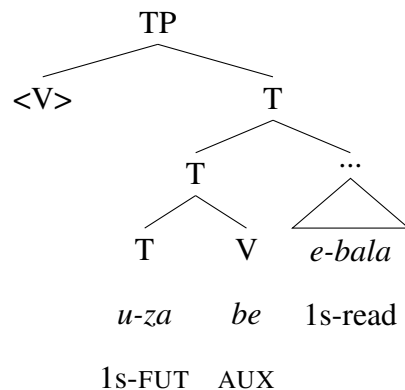
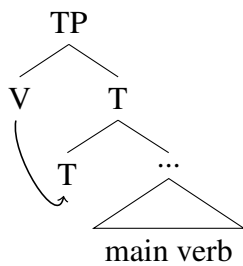

To sum up, I proposed that the emergence of synthesis and periphrasis is a consequence of Cyclic Selection, whereby a selectional feature not checked at merge triggers external merge of a specifier. Synthesis arises when a V-feature on an inflectional head can be checked at merge (by the lexical verb). Assuming cyclic application of syntactic operations, this mode of V-checking is always the first attempt. Periphrasis arises as a last resort way of checking the selectional V-feature, namely by triggering Sel-Merge of a new category goal. In this sense, default auxiliaries are expletive verbs – minimal elements of category V, inserted to satisfy a selectional requirement. This view of default periphrasis provides a straightforward answer to the Repair Question. Under the view of periphrasis as a repair strategy, periphrasis is a way of satisfying a grammatical requirement (c-selection) that would otherwise be violated. This Repair Question concerns the nature of the repair: why is the repair strategy auxiliary insertion and not anything else? The Cyclic Selection view proposed here gives the following answer: Sel-Merge of a new verb is a consequence of the main verb being inaccessible for V-checking. Thus, the failure of inflection to combine with the main verb is systematically related to the appearance of an auxiliary. This was the objective the objective for answering the Repair Question – deriving, rather than stipulating, auxiliary insertion as the repair strategy.

The remaining question concerns the actual failure. Under what circumstances is the main verb inaccessible for checking of a selectional feature of an inflectional head? The Failure Question is addressed in section 4.4, where I also combine the account of failure and repair to give an analysis of Ndebele compound tenses. Before that, however, the next subsection discusses some alternative answers to the Repair Question, showing how they fail to systematically relate the repair to the failure.

### 4.3.3 *Advantages over alternative approaches to the Repair Question*

We started this section by identifying the basic characteristic features of verbal periphrasis understood as a repair strategy (28).

- (28) Verbal periphrasis as a repair strategy:
- a. The failure: an inflection cannot combine with a verb
  - b. The repair: a new verb is inserted

A goal I set up at the beginning of the section was to derive the nature of verbal periphrasis and argued that this can be done only if we understand how the failure and the repair are related in the grammar (not just intuitively). The proposed analysis of Cyclic Selection achieves that goal by viewing both synthesis and periphrasis as different outcomes of the same syntactic operation – c-selection. Periphrastic syntax is derived by verb-selection in a configuration where the main verb is inaccessible for the selectional features on a functional head. The analysis proposed here builds on an idea put forth by Cowper (2010), who also argued that the relevant relation combining verbs with inflectional heads is c-selection. As such, Cowper’s analysis has the potential of providing the same answer to the Repair Question. The innovation I introduced to Cowper’s original idea is the notion of Cyclic Selection, where an unchecked selectional feature triggers Sel-Merge. To achieve the same effect of verb insertion, Cowper formulates the rule of *BE-support* (29-a), which applies when a selectional feature is not checked. In addition, Cowper defines a Merge-stranded head, which constitutes the structural description for the *BE-Support* rule (29-b).

- (29) Auxiliary insertion (Cowper, 2010:7)
- a. **BE-support:** The verb *be* is inserted immediately in a Merge-stranded Infl head.
  - b. **Stranded on Merge:** A head is stranded on Merge, or Merge-stranded, if it has an uninterpretable category feature that cannot immediately be checked.

What Cowper's account and the analysis proposed share is the stipulation that the inserted verb must be the verb *be*, not any other verb. Cowper implements this directly as a BE-insertion rule (29-a). In the proposed analysis, the *be*-requirement is stated as a condition on last-resort selection (24). Even though I do not have an answer to the question why last-resort selection should be subject to this condition, treating the *be*-requirement as a general property of last-resort selection allows us to draw an interesting parallel between the auxiliary *be* and nominal expletives, which have a similarly impoverished lexical content and apparently the same kind of trigger, namely c-selection. Moreover, the actual mechanism of auxiliary insertion proposed by Cowper is not c-selection. Despite the fact that the relation between verbs and inflections whose failure causes auxiliary insertion, the BE-support rule is not linked to c-selection in any formal way. The fact that the feature which failed to be checked is a selectional V-feature should be related to the fact that the inserted element is a verb. It seems redundant to additionally state a rule of verb insertion, such as the *BE-support* rule. The Cyclic Selection account draws the relevant connection between the failure and the repair. Accordingly, the Cyclic Selection implementation of this idea does not require defining a Merge-stranded head since we don't need it to serve as structural description for an insertion rule. The stranded inflection here is a selectional feature and since selectional features trigger Merge, we do not need any further stipulations to derive auxiliary insertion.

An explicit alternative analysis of default periphrasis was proposed by Bjorkman (2011). In Bjorkman's system, the failure and the repair are not related in the grammar: the mechanism combining inflections and verbs in synthesis is different than the one combining them in periphrasis. What combines verbs and inflections in a synthetic scenario is Infl-agreement. Verbs have an unvalued Infl-feature, while inflectional heads have both a valued and an unvalued Infl-feature (except for the highest inflectional head, which only has a valued Infl). As an example, consider the structure of a Future Perfect tense in (30). Given that the verb only has one unvalued Infl-feature and that Perf is more local to the verb than T, the Infl-feature on the verb must agree with Perf. This agreement relation ensures that perfect aspect can be expressed synthetically on the verb and

therefore will not trigger auxiliary insertion. This is the mode of combining verbs and inflection in the normal, synthetic case. When T is merged it controls agreement on Perf, valuing its uInfl-feature as FUT. Given that combining inflection with verbs is done by agreement, T in (30) fails to combine with the verb.

(30) a. Syntax

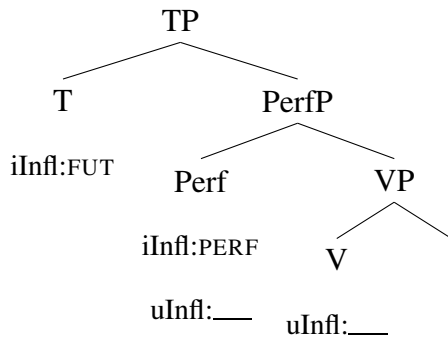

b. Morphology

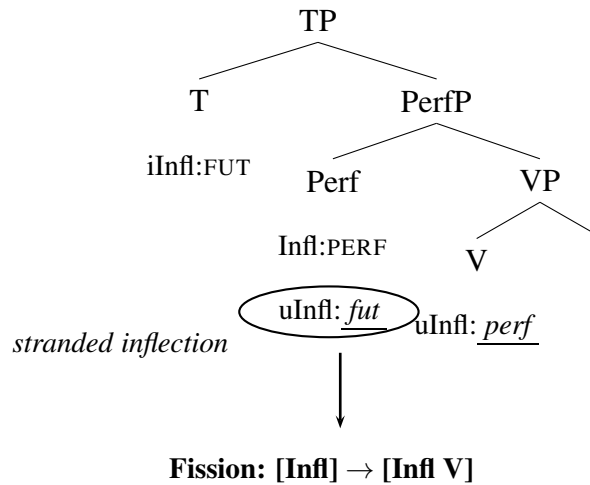

Periphrasis is the result of a different mechanism. First of all, it is a morphological phenomenon. The structure in (30)-b is syntactically well-formed in Bjorkman's account. What goes wrong in this case is that one of the uInfl-features is not in the same complex head as the verb, violating the requirement that every uInfl must be in a complex head with a verb. In (30), the offending feature is uInfl:FUT on Perf, defined in Bjorkman as *stranded inflection* (interpretable Infl-features are not subject to this requirement). Similarly to Cowper's analysis, a stranded inflection constitutes the context for a rule inserting an auxiliary verb. For Bjorkman, this rule is the morphological rule of fission, splitting the stranded inflection into itself and a V, as shown in (30)-b.

The approach to default periphrasis proposed here has the following two advantages over Bjorkman's proposal. The first one has to do with the concept of stranded inflection. As intuitive as it seems in the discussion of default periphrasis, a "stranded inflection" has had no appearance in

the syntactic theory in any principled way and outside of the literature on periphrasis. In fact, syntactic derivations frequently give rise to structures that could be characterized as involving stranded inflections. It is unclear, for instance, why interpretable Infl features do not count as stranded, e.g. the [iInfl:Fut] in (30). The analysis proposed here derives auxiliary insertion without the need to define "stranded inflection" as a theoretical object that the grammar makes reference to. The second advantage concerns the potential to answer the Repair Question in a way that will provide an understanding of why a stranded inflection triggers insertion of a verb. In Bjorkman's account, this property is stipulated as a fission rule. In the Cyclic Selection proposal, the requirement for a verb falls out from the nature of the stranded feature: it is a selectional feature, which by definition triggers merge of the relevant category. Thus the view advocated here provides a more explanatory account of periphrasis.

#### **4.4 Deriving the overflow pattern in Ndebele**

In the previous section, I concentrated on answering the Repair Question and proposed that the reason the failure of an inflection to combine with a verb is repaired by auxiliary insertion is because the mechanism combining verbs and inflections is c-selection for a verbal category – a feature that, when not satisfied, triggers merge of the required category. In this section, I address the Failure Question, i.e. under what circumstances is the main verb inaccessible to check a selectional feature on a functional head. I propose that the failure arises due to the way V-checking and Infl-agreement interact. In particular, I adapt Cowper's account, in which V-checking requires the target category feature to be active (have an unvalued Infl-feature). I modify the activity condition on V-checking in such a way that it can also apply to languages with the overflow pattern of auxiliary use, like Ndebele. I then provide a full account of all compound tenses in Ndebele: Imperfective, Perfect and Prospective tenses.

#### 4.4.1 *The interaction between V-selection and Infl-agreement: deriving imperfective tenses*

In chapter 3, I introduced the mechanism of Infl-agreement, whereby Infl-values are transferred downward to the most local unvalued Infl-feature. Lexical verbs and default auxiliaries have an unvalued Infl-feature, as shown in (31).

- (31) a. Default auxiliary:
- $$\left[ \begin{array}{l} \text{CAT: } \langle \text{V}, 0 \rangle \\ \text{Infl: } \text{---} \end{array} \right]$$
- b. Lexical verb:
- $$\left[ \begin{array}{l} \text{CAT: } \langle \text{V}, 1 \rangle \\ \text{Infl: } \text{---} \\ \text{SEL: } \text{X} \end{array} \right]$$

Inflectional heads, on the other hand, have a valued inflectional feature which corresponds to the inflectional meaning of the particular head. Let us focus first on the inflectional heads involved in the formation of imperfective tenses, namely T and Asp. Ndebele makes the following distinctions in the domain of inflectional categories. In the domain of viewpoint aspect (AspP), we distinguish imperfective and perfective aspect (different types of imperfective aspect, such as progressive and habitual, are not formally distinguishable and I treat them as possible interpretations of the imperfective feature). I propose that the perfective–imperfective opposition is encoded privatively, by the presence or the absence of Infl:IMPF on the Asp head, as shown in (32). Additionally, all the lexical entries below represent the selectional V-features proposed in the previous section to appear on every non-verbal head in the functional spine.

- (32) a. Imperfective Asp head:
- $$\left[ \begin{array}{l} \text{CAT: } \langle \text{Asp}, 3 \rangle \\ \text{Infl: } \text{IMPF} \\ \text{SEL: } \text{V} \end{array} \right]$$
- b. Perfective Asp head:
- $$\left[ \begin{array}{l} \text{CAT: } \langle \text{Asp}, 3 \rangle \\ \text{SEL: } \text{V} \end{array} \right]$$



The privative inflectional contrast will be used as a marker of syntactic (un)markedness involved in default periphrasis: syntactically marked inflection is one which is present, while syntactic unmarkedness is absence of a feature (Harley & Ritter, 2002; Cowper, 2005).

In the tense domain, Ndebele makes a three-way distinction: present (33), past (34) and future (35). Within past tenses, the language additionally makes remoteness distinctions: Distant Past (34-a) and Recent Past (34-b).

- |      |  |                     |
|------|--|---------------------|
| (33) | Ngi- ∅- bal -a ibhuku.<br>1sg.s- PRES- read -FS.PRES 5book<br>'I read books'                       | <i>Present</i>      |
| (34) | a. Ngi- a- bal -a ibhuku.<br>1sg.s- DPST- read -FS.DPST 5book<br>'I read a book (a long time ago)' | <i>Distant Past</i> |
|      | b. Ngi- ∅- bal -e: ibhuku.<br>1sg.s- RPST- read -FS.RPST 5book<br>'I read a book (recently)'       | <i>Recent Past</i>  |
| (35) | Ngi- za- bal -a ibhuku.<br>1sg.s- FUT- read -FS.FUT 5book<br>'I will read a book'                  | <i>Future</i>       |

As shown in (36), present tense is assumed to be unmarked – it is encoded by the absence of an Infl-feature on T. Note also that the remoteness distinction is encoded by a Infl:DPST feature on the distance past T, while the recent past T has Infl:PST.

- |      |   |   |
|------|---|---|
| (36) | a. Present T:   | b. Future T:  |
|      | $\left[ \begin{array}{l} \text{CAT: } \langle T, 5 \rangle \\ \text{SEL: } V \end{array} \right]$ | $\left[ \begin{array}{l} \text{CAT: } \langle T, 5 \rangle \\ \text{Infl: } \text{FUT} \\ \text{SEL: } V \end{array} \right]$ |

c. Distant Past T:

$$\begin{bmatrix} \text{CAT:} & \langle T,5 \rangle \\ \text{Infl:} & \text{DPST} \\ \text{SEL:} & \text{V} \end{bmatrix}$$

d. Recent Past T:

$$\begin{bmatrix} \text{CAT:} & \langle T,5 \rangle \\ \text{Infl:} & \text{PST} \\ \text{SEL:} & \text{V} \end{bmatrix}$$

A crucial addition to the analysis of periphrasis is a constraint on V-checking, proposed by Cowper (2010), namely the requirement that the category target, the verb, have an unvalued Infl-feature. As long as the verb's Infl-feature is remains unvalued, its category feature may continue to check selectional features on inflectional heads. The moment it receives a value, it becomes inaccessible for further checking (in this sense, the Infl-feature is an activity feature, and plays a similar role to Case-features in Chomsky's (2000) theory of agreement as being strictly connected to Case-checking). I amend this condition slightly, making it applicable only for inflectional heads which have an Infl-value to share (37). As we will see shortly, this amendment is necessary to also account for languages with the overflow pattern of auxiliary use.

(37) **Activity condition on V-checking**

A selecting head with an Infl-feature may only check its selectional feature against a matching head with an unvalued Infl-feature. That is:

- a.  $F_{[\text{SEL:V, Infl}]}$  is subject to the activity condition
- b.  $F_{[\text{SEL:V}]}$  is not subject to the activity condition

With the lexical entries and the Activity Condition at hand, we can see how Infl-agreement and Cyclic Selection apply to derive synthesis and periphrasis in perfective and imperfective tenses.

As discussed above, perfective aspect has no morphological or syntactic manifestations: it is morphologically unmarked and does not trigger periphrasis. In other words, perfective forms are synthetic. This unmarkedness of the perfective aspect is reflected in the absence of an Infl feature on Asp. Thus, the structure of a Simple (Perfective) Future is that in (38) (In the trees,

I use simplified feature matrices, omitting category features of functional heads and level values of category features, since neither are of immediate relevance.) When Asp is merged with vP, its selectional V-feature finds a matching goal, namely v. Since Asp is unmarked, i.e. has no Infl-feature, the activity condition on checking does not apply. T, on the other hand, has an Infl-feature and therefore requires a goal with an unvalued Infl. The main verb hasn't been valued by Asp and so is still accessible to T for checking. At the same time, Infl-agreement takes place, valuing the main verb's Infl as FUT.

- (38) U- za- dl -a.  
 2sg.s- FUT- eat -FS.FUT  
 'You will eat'.

Asp: V-checking

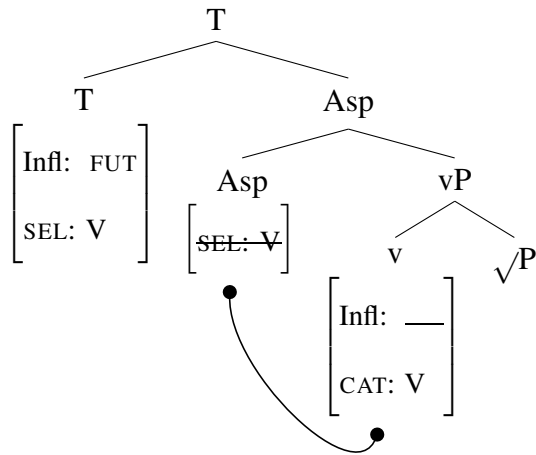

T: V-checking and Infl-agreement

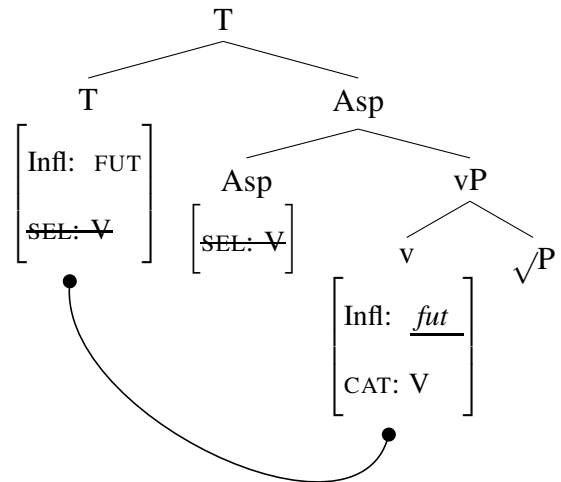

Since selectional features of all inflectional heads are checked by the main verb in (38), last-resort selection (i.e. Sel-Merge of a new verb) cannot be triggered and the expression of perfective future is necessarily synthetic. The same is true of past and present tenses occurring with unmarked aspect, as shown in (39) and (40), respectively.

(39) U- ∅- dl -ile.  
 2sg.s- RPST- eat -FS.RPST  
 'You ate'.

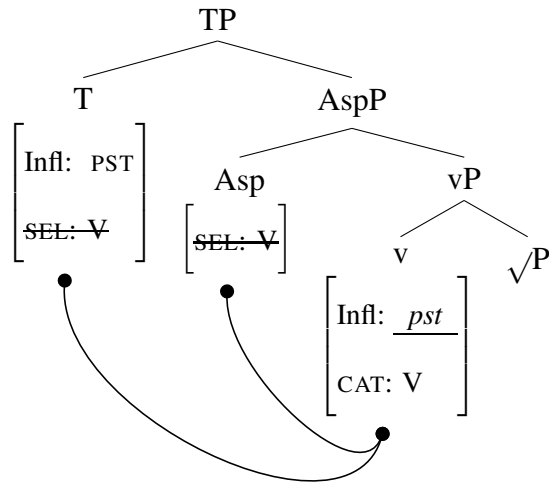

(40) U- ya- dl -a.  
 2sg.s- PRES.DSJ- eat -FS.PRES  
 'You eat'.

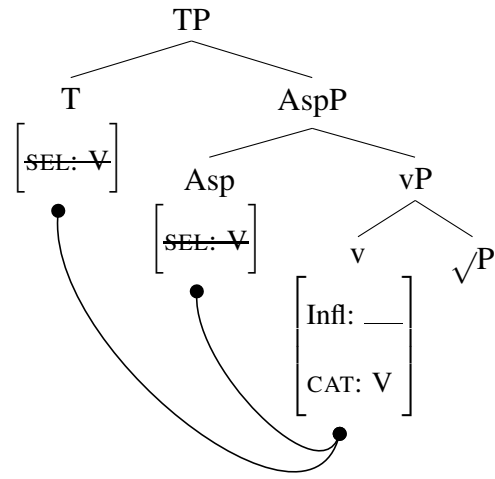

Note that, like perfective aspect, present tense is syntactically unmarked – it has no Infl-feature. This means that in a simple present tense, such as (40), there is no head that can value the verb's Infl. I assume that a probe which does not enter in an agree relation does not disrupt the derivation in any way (Preminger, 2011, 2014). The verb then surfaces with default, present tense morphology.

Imperfective aspect, being syntactically marked, interacts with V-checking in a different way. In a Future Imperfective tense, for instance, both Asp and T have Infl-features and therefore are both subject to the Activity Condition on V-checking. As we see in (41), Asp, being more local to the verb than T, checks its selectional feature against the still active v. Asp also has a valued Infl-feature and Infl-agreement between Asp and v takes place resulting in valuation of the verb's Infl-feature. Once T becomes part of the derivation, it seeks a matching category goal. Since T has an Infl-feature, it is subject to the Activity Condition on V-checking, requiring the matching

goal to be an active head, i.e. one with an unvalued Infl-feature. This requirement is not met by the main verb at this point in the derivation.

(41) Derivation of Future Imperfective: Failure

Asp: V-checking and Infl-agreement

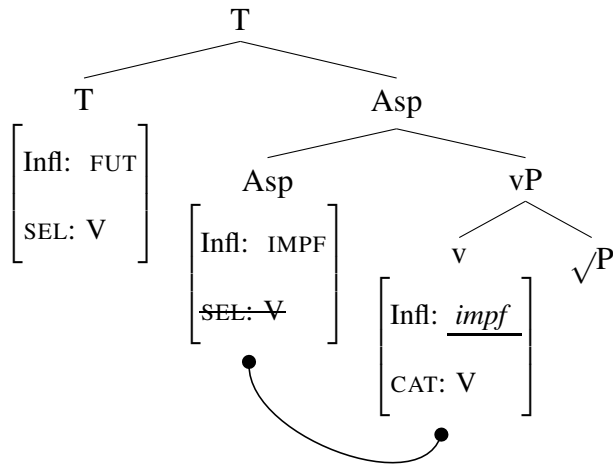

T: no active goal for V-checking

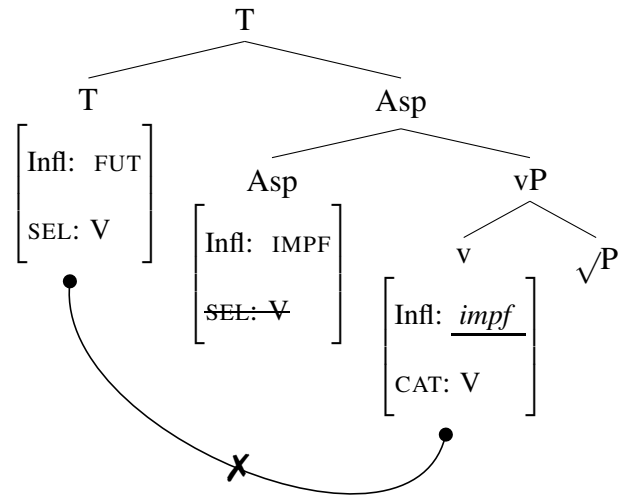

In effect, the selectional feature on T remains unchecked and triggers merge of a matching category as its specifier (42), giving rise to auxiliary insertion.

(42) Derivation of Future Imperfective: Repair

Sel-Merge of an expletive V

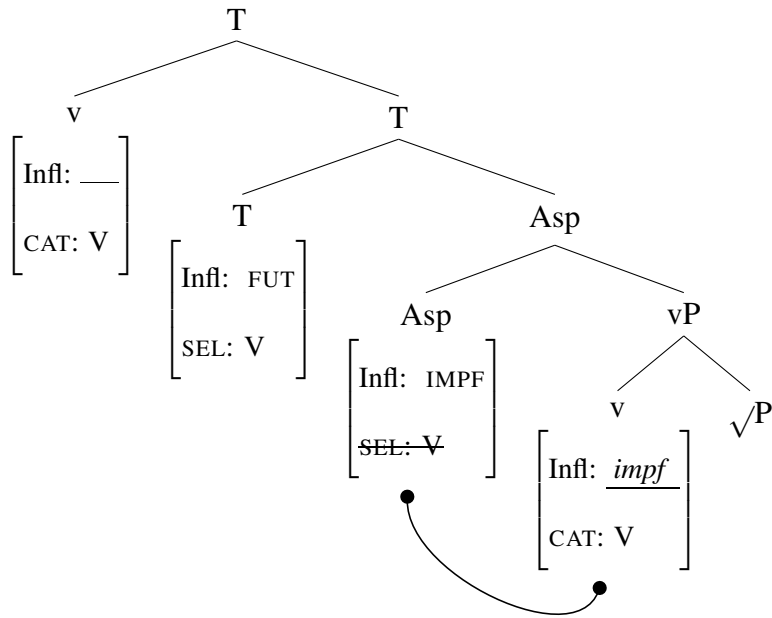

T: V-checking, Infl-agreement and m-merger

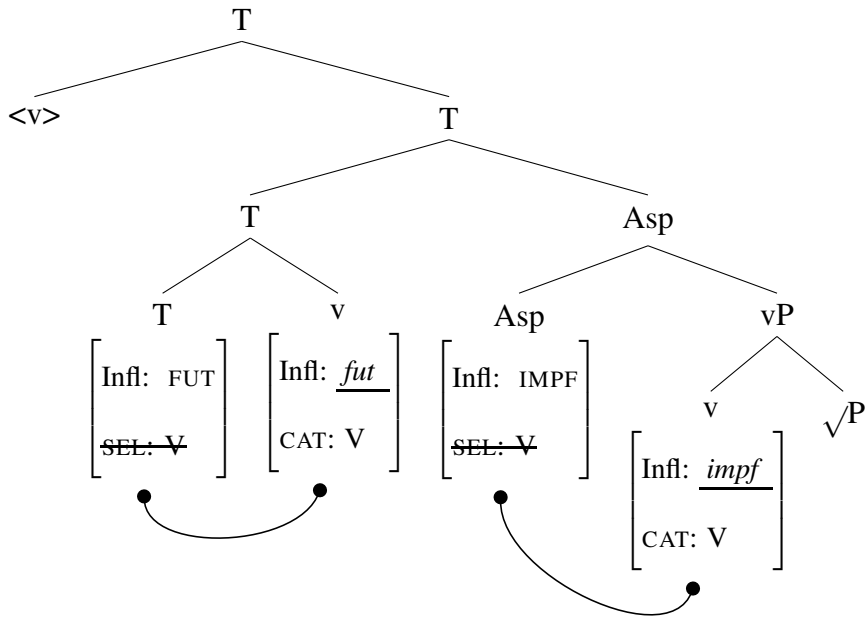

Consequently, imperfective aspect requires a periphrastic expression whenever T is also marked, namely in the past or future tense (43). Recall, however, that Ndebele does not have present imperfective tense that's also periphrastic (section 4.2.1). Rather, imperfective aspect is expressed synthetically in the present, as shown in (43-d). This is the overflow pattern we find in Ndebele: imperfective aspect cannot be thought of as requiring an auxiliary verb; it does not require one in the present tense.

(43) The overflow pattern with imperfective aspect

- |    |  |                                |
|----|--|--------------------------------|
| a. | U-za-be          u-bal-a.<br>2sg.s-FUT-AUX 2sg.s-read-FS<br>'You will be reading/You will read habitually' | <i>Future Imperfective</i>     |
| b. | U-a-be          u-bal-a.<br>2sg.s-DPST-AUX 2sg.s-read-FS<br>'You were reading/You used to read'.           | <i>Dist. Past Imperfective</i> |
| c. | U-∅-be          u-bal-a.<br>2sg.s-RPST-AUX 2sg.s-read-FS<br>'You were reading/You used to read'.           | <i>Rec. Past Imperfective</i>  |
| d. | U-ya-bal-a.<br>2sg.s-PRES-read-FS<br>'You are reading/You read habitually'                                 | <i>Present Imperfective</i>    |

The overflow effect is a consequence of the unmarked status of present tense: having no Infl-feature, present tense T is not subject to the Activity Condition. Unlike past or future tenses, its selectional V-feature can be checked against the main verb despite the fact that the verb's Infl-feature has been valued by Asp. The derivation of Present Imperfective is given shown in (44).

(44) Derivation of Present Imperfective (synthesis)

Asp: V-checking and Infl-agreement

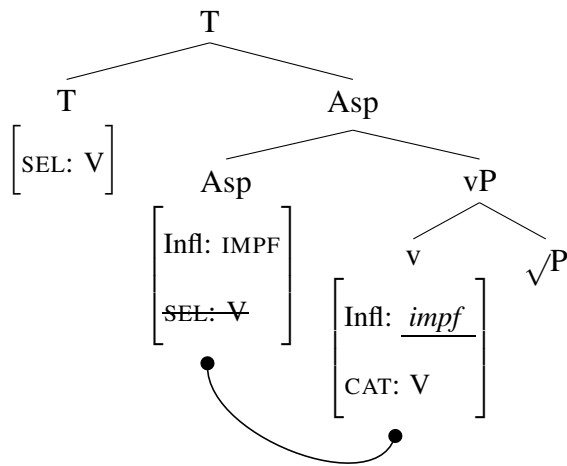

T: V-checking

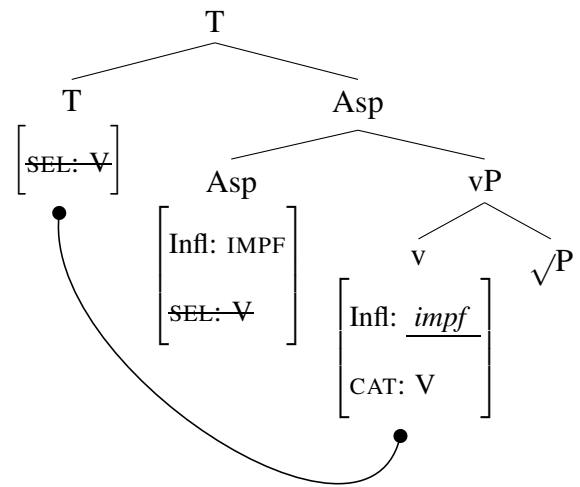

Auxiliary insertion in the proposed analysis is not tied to a particular inflectional feature, but rather to cooccurrences of inflectional features. In particular, there can be only one marked inflectional head in a synthetic expression, but it doesn't matter what inflection it is. This aspect of the proposed analysis derives the overflow pattern of auxiliary use, in which periphrasis is triggered by the overall inflectional complexity, not by a specific inflection. The hypothesis that present tense is encoded as the absence of an Infl-feature predicts that there are no periphrastic present tenses. We've seen in this section that there are no periphrastic present tenses with imperfective aspect. In the next section, I discuss two other types of tenses, perfect and prospective, and show that the prediction is borne out with those inflections as well: there is no periphrastic present perfect and no periphrastic present prospective tense.



#### 4.4.2 *An extension to perfect and prospective tenses: a lower T*

In the assumed functional hierarchy, perfect aspect is introduced by the Perf head, located right below T. In Ndebele, perfect participles are morphologically identical to recent past forms, as shown in (45) for the disjoint form and in (46) for the conjoint form. In both the simple past tense and the perfect participle, the final suffix is *-ile* (disjoint form) or *-e:* (conjoint). Similarly, both forms lack an overt prefix other than the subject agreement marker.

- (45) a. U-∅-phek-ile.  
 2sg.s-PST-cook-PST.DSJ  
 ‘I cooked (recently).’
- b. U-∅-be            u-phek-ile.  
 2sg.s-PST-AUX 2sg.s-cook-PST.DSJ  
 ‘I had cooked.’
- (46) a. U-∅-phek-e:            isuphu.  
 2sg.s-PST-cook-PST.CNJ 7soup  
 ‘I cooked soup (recently).’
- b. U-∅-be            u-phek-e:            isuphu.  
 2sg.s-PST-AUX 2sg.s-cook-PST.CNJ 7soup  
 ‘I had cooked soup.’

The morphological similarity between past tense and perfect aspect is not uncommon crosslinguistically and can also be observed in English, where regular past participles are syncretic with regular past tense forms (see the translations in (45)). In addition to the morphological affinity, perfect aspect has been argued to be semantically related to past tense and analyzed as a lower occurrence of past tense (Hoffman, 1966; Bach, 1967; von Stechow, 1995; McCawley, 1971, 1988; Klein, 1992, 1994; Cinque, 1999; Julien, 2001; Stowell, 2007; Arregi & Klecha, 2015; Sigurðsson, 2015). According to some of those analyses, perfect tenses are structured with two tense projections, where the lower (non-finite) one has the value [PAST]. Although I have been using the category label Perf for the head responsible for perfect aspect, the distribution of tense morphology in Ndebele provides evidence supporting the hypothesis of two tense projections. In addition to

past tense morphology, participles in Ndebele may host future tense morphology. Consider the pair in (47) which shows that the two tense inflections, past and future, can cooccur and can appear in either order: the expression of Future Perfect involves a future tense marker on the auxiliary and a past tense marker on the main verb, while a the reverse order gives rise to what is called a Past Prospective tense (also referred to as future of the past).<sup>6</sup>

- (47) a. U- **za-** be u- phek- **ile.** Fut + Past = *Future Perfect*  
 2sg.s- FUT AUX 2sg.s- cook -PST  
 ‘You will have cooked’
- b. U- ∅- be u- **za-** pheka. Past + Fut = *Past Prospective*  
 2sg.s- PST AUX 2sg.s- FUT- cook  
 ‘You were going to cook’

For this reason, what I have been calling the Perf head is really a lower past tense, and as such it may host the Infl-features that can appear on T, namely Infl:PST, Infl:FUT or no Infl-feature (unmarked tense). A lower past tense is what we call perfect aspect, while a lower future tense is the so called prospective aspect (48).

- (48) [<sub>T</sub> PST/FUT [<sub>T</sub> PST/FUT ]]  
 past/future perfect/prospective

In what follows, I use the label T<sub>Perf</sub> for a lower T with a Infl:PST feature, and the label T<sub>Prosp</sub> for a lower T with Infl:FUT. Since the lower T makes no remoteness contrasts, I assume that the distant past Infl-feature is not available for this head.<sup>7</sup> The syntax of a perfect tense is shown in (49), and that of a prospective tense is in (50).

---

6. Though Perfect and Prospective tenses in Ndebele have received very little attention (some discussion can be found in Sibanda (2004); Burkholder (2014)), they are thoroughly described for Zulu, a closely related language (Doke, 1950; Posthumus, 2008; Hall, 2005).

7. A related Bantu language, Shona, has remoteness contrasts in both past and future tenses, and they can be expressed on both the higher and the lower T (Toews, 2009).

(49) A perfect tense

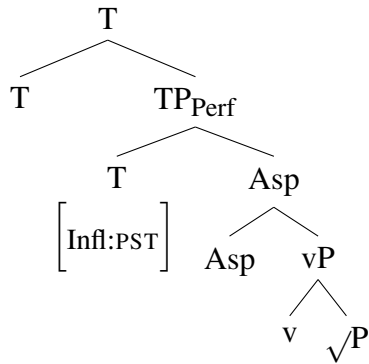

(50) A prospective tense

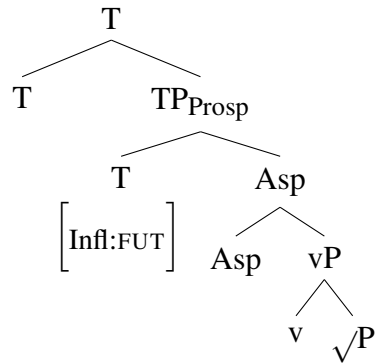

Periphrasis triggered by the interaction of the two T heads shows the same overflow pattern that we saw with T and Asp in the previous section. In particular, any combination of two Ts that contains only one head with an Infl-feature is synthetic. Any combination in which both Ts have an Infl feature must be periphrastic. That is, all the tenses in (51)-a are synthetic, while the tenses in (51)-b are periphrastic. Note that the combination of two future Ts is impossible in Ndebele, though allowed in other Bantu languages, e.g. in Shona (Toews, 2009).

(51) Combination of Tense features and their expression:

	T	>	T <sub>Perf/Prosp</sub>	tense	example translation
a.	∅		∅	<i>Simple Present</i>	'I cook'
	PST		∅	<i>Simple Past</i>	'I cooked'
	FUT		∅	<i>Simple Future</i>	'I will cook'
	∅		PST	<i>Present Perfect</i>	'I have cooked'
	∅		FUT	<i>Present Prospective</i>	'I am going to cook'
b.	PST		PST	<i>Past Perfect</i>	'I had cooked'
	PST		FUT	<i>Past Prospective</i>	'I was going to cook'
	FUT		PST	<i>Future Perfect</i>	'I will have cooked'
	*FUT		FUT	<i>(Future Prospective)</i>	Intended: 'I will have a plan to cook'

Since present tense in Ndebele is unmarked (no Infl-feature), it does not contribute to the complexity triggering periphrasis. Crucially, which T head will be unmarked is irrelevant. E.g. Simple Past and Present Perfect have the same set of features ( $\emptyset$  and Infl:PST) occurring in a different order, and both are synthetic. This is the hallmark of the overflow pattern. Periphrasis is not tied to a particular inflection but to their overall amount. In Ndebele, we cannot say that perfect aspect requires an auxiliary (like in English). All we can say is that perfect aspect is more likely to be expressed periphrastically than its absence because it is a marked inflection. Only when the lower T is unspecified can the higher T have an Infl-value and be expressed synthetically, and vice versa.

Let us first focus on synthetic tenses (51)-a. All synthetic tenses, i.e. tenses corresponding to combinations of Ts with at least one unmarked T, are given in (52). I use Recent Past as an example of a past tense (Distant Past behaves the same way with respect to periphrasis).

(52) Only one marked tense  $\Rightarrow$  *synthesis*

- |    |   |                            |
|----|---|----------------------------|
| a. | U- $\emptyset$ - phek -a inyama.<br>2sg.s- PRES- cook -FS.PRES 9meat<br>'You cook meat'.          | <i>Simple Present</i>      |
| b. | U- $\emptyset$ - phek -e: izolo.<br>2sg.s- PST- cook -FS.PST yesterday<br>'You cooked yesterday'. | <i>Simple Past</i>         |
| c. | U- za- phek -a kusasa.<br>2sg.s- FUT- cook -FS.FUT tomorrow<br>'You will cook tomorrow'.          | <i>Simple Future</i>       |
| d. | U- $\emptyset$ - phek -e: khathesi.<br>2sg.s- PST- cook -FS.PST now<br>'You have now cooked'.     | <i>Present Perfect</i>     |
| e. | U- za- phek -a khathesi.<br>2sg.s- FUT- cook -FS.FUT now<br>'You are now going to cook'.          | <i>Present Prospective</i> |

Looking at the paradigm in (52), an interesting observation can be made: we see formal identity

between tenses with a past tense feature (Simple Past and Present Perfect), and with a future tense feature (Simple Future and Present Prospective). Since the forms in each pair are morphologically indistinguishable, it is possible that (52-b), for instance, is not structurally/featurally ambiguous, as suggested here, but rather it is a simple past with an optional perfect-like interpretation. The same can be said about Simple Future and Present Prospective. There is reason to think, however, that the featural ambiguity view is on the right track. First, we do see manifestations of a lower T with future and past inflections in compound tenses, i.e. when the higher T is non-present. As we see in (53), Ndebele has both past and future participles.

- (53) a. U- za- be u- phék- ile. Fut + Past = *Future Perfect*  
 2sg.s- FUT- AUX 2sg.s- cook -PST  
 ‘You will have cooked’
- b. U- ∅- be u- phék- ile. Past + Past = *Past Perfect*  
 2sg.s- PST- AUX 2sg.s- cook -PST  
 ‘You will have cooked’
- c. U- ∅- be u- za- phéka. Past + Fut = *Past Prospective*  
 2sg.s- PST- AUX 2sg.s- FUT- cook  
 ‘You were going to cook’

(53) shows that both the higher and lower T can have an Infl-value. It would, then, be puzzling if the lower one could not have an Infl-value only in case the higher T is present tense (unmarked). The featural decomposition of tenses proposed in (51) provides a more uniform account, even if some of the featural distinctions are morphologically opaque. In fact, I will demonstrate shortly, the the formal identity of Present Perfect and Simple Past, as well as Simple Future and Present Prospective, is naturally accounted for by the Infl-agreement analysis proposed here. Moreover, the compatibility of the apparent past tense and future tense with the temporal adverbial *khathesi* ‘now’, might be treated as evidence that the higher T in these forms is a present tense T, i.e. one that’s compatible with the meaning of ‘now’ (52-d)-(52-e).

A final argument for distinguishing the formally identical pairs in (52) comes from a morphophonological alternation, called imbrication, which applies to the past tense suffix *-ile* in certain

morphophonological contexts. It has been observed for Zulu, a language with remarkably similar morphology, that imbrication is obligatory in perfect forms, but optional in past tense (Botne & Kershner, 2000). As an example of imbrication of the suffix *-ile*, consider the verb *lala* ‘sleep’. As we see in the Ndebele example in (54), after imbrication, the suffix *-ile* is shortened to *-e*, and the vowel of the root raises to *e*.

- (54) Ngi- lal -ile ⇒ ngi- lel -e  
 1sg- sleep -PST 1sg- sleep -PST

In the examples below, I use temporal adverbials ‘yesterday’ and ‘now’ to diagnose the hypothesized difference between the formally identical forms, where ‘yesterday’ indicates the Simple Past tense, while ‘now’ is meant to diagnose Present Perfect. As we see in (55), imbrication is optional if the temporal adverbial indicates Simple Past (i.e. the higher T with Infl:PST). But in the context of ‘now’, suggesting that the past tense morphology comes from the lower T, not the higher one, imbrication is obligatory (56).

- (55) Simple Past → imbrication optional

- a. U- lal -ile izolo  
 1- sleep -PST yesterday  
 ‘He slept/fell asleep yesterday’
- b. U- lel -e izolo  
 1- sleep -PST yesterday  
 ‘He slept yesterday’

- (56) Present Perfect → imbrication obligatory

- a. \*U- lal -ile khathesi  
 1- sleep -PST now  
 (‘He’s (fallen) asleep now’)
- b. U- lel -e khathesi  
 1- sleep -PST now  
 ‘He’s (fallen) asleep now’

As expected, past participles in compound tenses require imbrication. There, semantic disambiguation by adverbs is not necessary – perfect aspect is visible through periphrasis (57)-(58).

(57) Future Perfect → imbrication obligatory

- a. \*U-za-be e- lal -ile  
1-FUT-AUX 1- sleep -PST  
(‘He will have fallen asleep ’)
- b. U-za-be e- lel -e  
1-FUT-AUX 1- sleep -PST  
(‘He will have fallen asleep/He will be asleep ’)

(58) Past Perfect → imbrication obligatory

- a. \*U-∅-be e- lal -ile  
1-PST-AUX 1- sleep -PST  
(‘He had fallen asleep ’)
- b. U-∅-be e- lel -e  
1-PST-AUX 1- sleep -PST  
(‘He had fallen asleep/He was asleep ’)

The sensitivity of imbrication to past vs perfect inflection suggests that the homophonous past tense morphology in Simple Past and Present Perfect originates on morphosyntactically different categories, supporting the featural ambiguity view. Unfortunately, I am not aware of a similar process that would distinguish Simple Future and Present Prospective, but I will assume a uniform treatment of this pair and the past–perfect pair, namely that both are featurally ambiguous expressions.

Let us now see how the analysis proposed here derives simple tenses and the ambiguities described above. We have already seen the derivation of simple tenses, i.e. those without marked Asp or Perf. If the higher T is also unmarked, the main verb’s Infl-feature remains unvalued and is spelled out as the default, present tense form (59). Notice that, unlike in the discussion of simple tenses in the previous section, I represent the lower T here as well, even though it is unmarked and does not contribute to the meaning (in any obvious way) or to periphrasis. For this reason, an

unmarked lower T is typically omitted in trees later in the thesis, but in this particular case it is best to represent it explicitly.

(59) Simple Present (synthesis)

- a. U- ya phek -a.  
 2s- PRES.DSJ- cook -FS.PRES  
 ‘You cook’.

b.

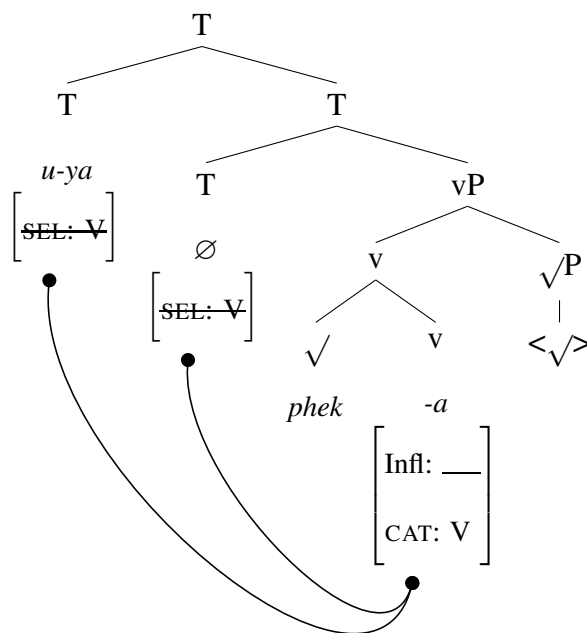

Infl-valuation takes place when one of the T heads has an Infl-feature. The two structures below show derivations of Simple Past and Present Perfect, which differ only in the position in which the past tense inflection originates (60).



(60) Simple Past/Present Perfect (synthesis)

U-  $\emptyset$ - *phek -ile*.  
 2s- PST- cook -FS.PST  
 'You cooked/You have cooked'.

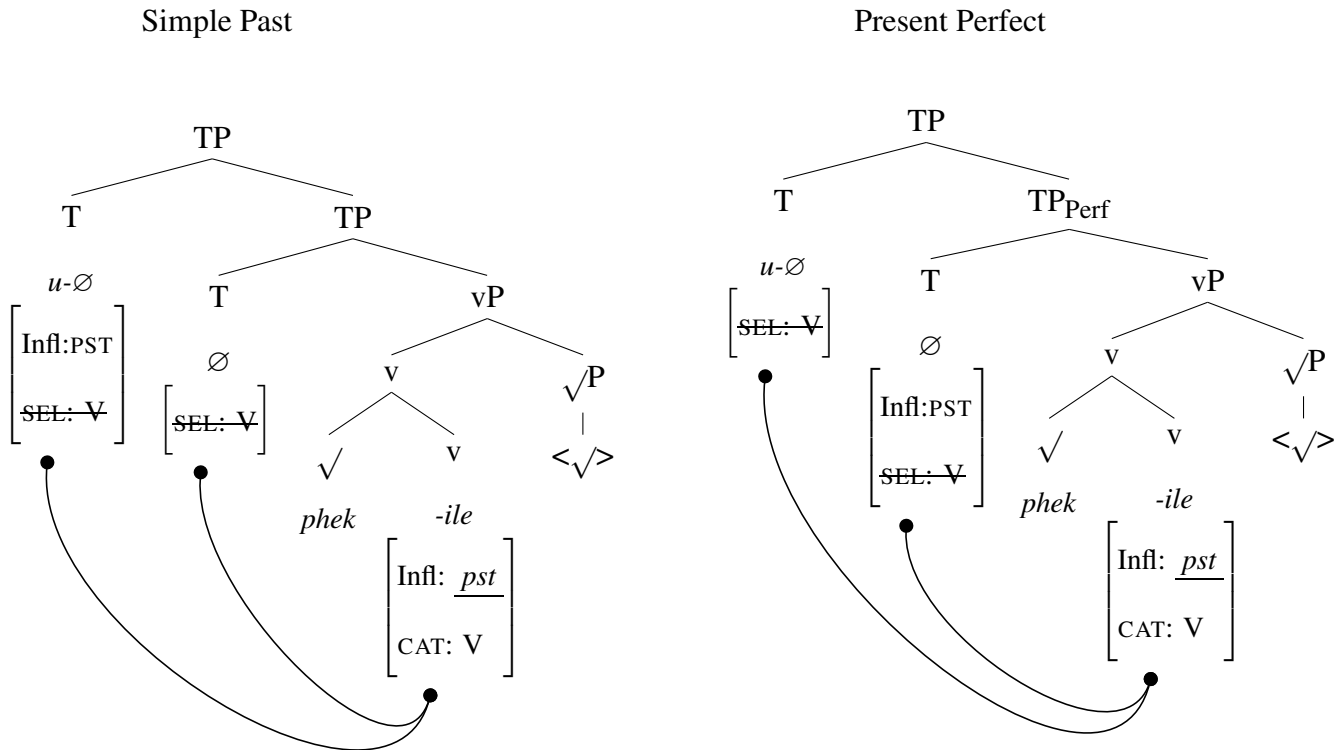

Whether the past tense feature originates on the higher T (Simple Past) or on the lower T (Present Perfect), the expression is synthetic – the overflow effect. In Simple Past, the lower T is unmarked, i.e. it only has a selectional feature. Checking of that feature does not result in Infl-valuation, and so the main verb stays active for V-checking on the higher T. Since both V-features can be checked against the main verb, no last-resort selection of a verbal expletive (the default auxiliary) can take place. In Present Perfect, the lower T does value the main verb's Infl. However, since the higher T is unmarked, it is not subject to the activity condition and can also check its selectional V-feature against the main verb, resulting in a synthetic expression, as well. The morphology of Simple Past and Present Perfect is the same for the following reasons. The

exponents of a present T and a past tense T are both null, and so the prefixal material consists only of the subject agreement prefix in both cases (by assumption, located in the higher T; see chapter 6 for a detailed discussion of agreement prefixes). The past tense feature is additionally realized on the Final Suffix, the exponent of little *v*. Since in both cases, the Infl-feature on *v* is valued as past (though by different heads), the featural composition of *v* is the same in both tenses and so has the same exponent, namely the suffix *-ile* (or *e:* in the conjoint form).

The relation between Simple Future and Present Prospective is similar. Both tenses are synthetic and have morphologically identical expression (61).

(61) Simple Future/Present Prospective (synthesis)

U- za phek -a.  
 2s- FUT- cook -FS.FUT  
 ‘You will cook/You are going to cook.’

Simple Future

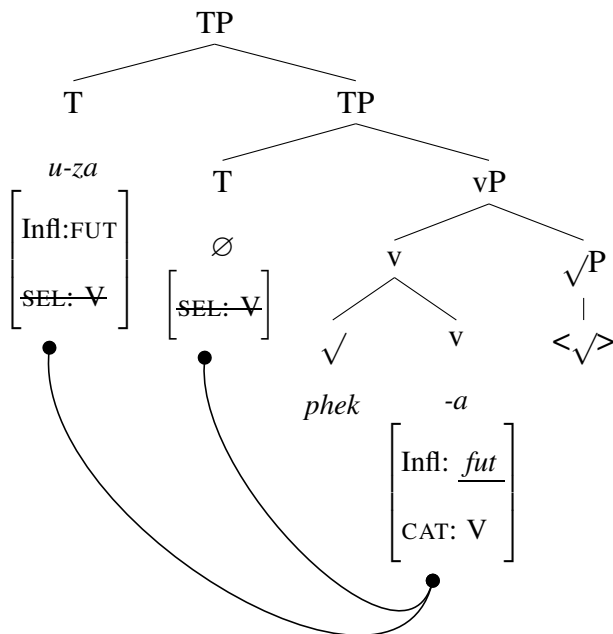

Present Prospective

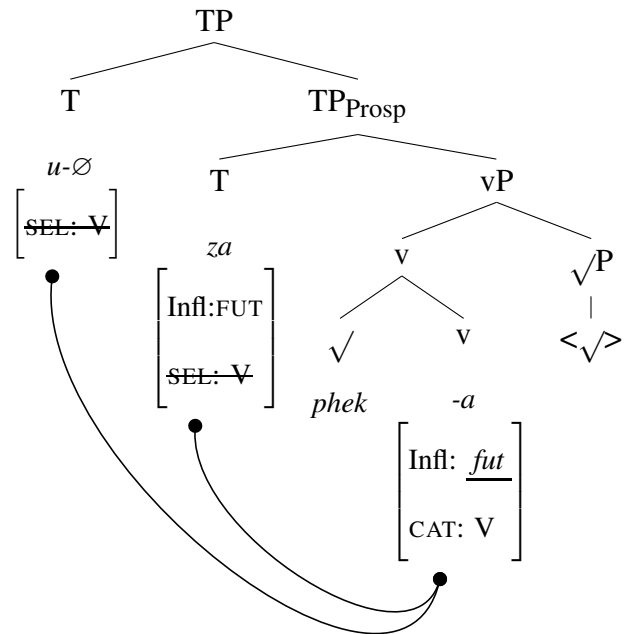

Again, synthesis arises in both tenses because both T heads can check their selectional V-feature against the main verb. Little *v*'s Infl-feature is valued as FUT in both cases and therefore has the same exponent (here *-a*). Finally, a T with a Infl:FUT is realized as *za-*. As we see in the trees in (61), the prefix *za-* is located in different positions, depending on which head has the future tense feature: the higher T in Simple Future, and the lower T in Present Prospective. Since an unmarked T is null, this difference is string vacuous and both tenses end up with the same affix order.

Finally, periphrasis arises when neither of the two T heads is unmarked. Recall that Ndebele has three periphrastic tenses resulting from the interaction of tense features: Future Perfect, Past Perfect and Past Prospective. The first step in the derivation of Future Perfect is shown in (62). As we see, this tense is composed of a higher future and a lower past. Since the lower T has an Infl-feature, it values the Infl-feature on *v*, rendering it inactive for V-checking. The higher T, being a marked head, requires an active goal, and consequently cannot check its V-feature against the main verb.

(62) Future Perfect (periphrasis)

U- za-be u-phek -ile.  
 2sg.s- FUT-AUX 2sg.s-cook -FS.PST  
 'You will have cooked.'

T<sub>Perf</sub>: V-checking and Infl-valuation

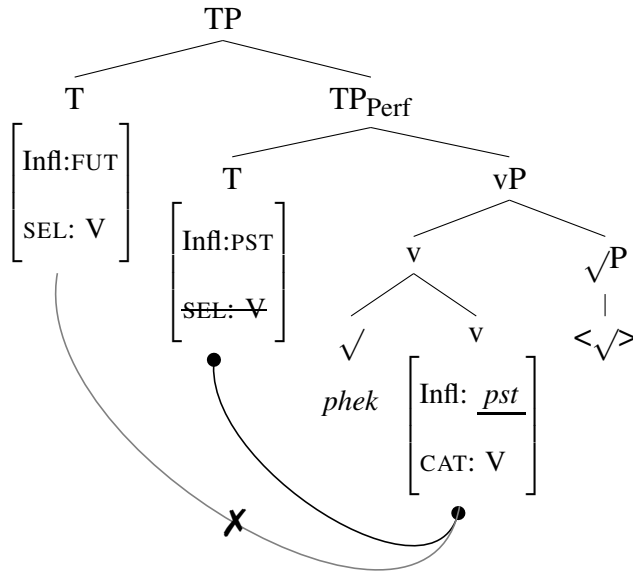

The selectional V-feature on the higher T remains active and triggers selection-driven merge (Sel-Merge) of a verbal expletive, the default auxiliary (63).

(63) Future Perfect: Sel-merge of an auxiliary, V-checking and Infl-valuation

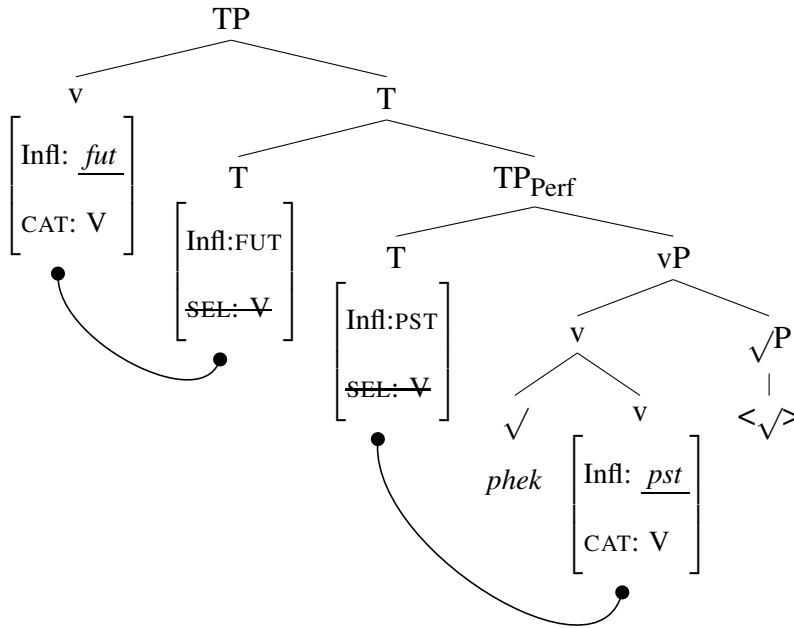

The final step in the derivation is m-merger of the newly merged auxiliary verb with T. The structure below is the final output of the derivation of a Future Perfect expression, and specifies the exponents of each head (64).



(65) Past Perfect (periphrasis)

U- ∅-be u-phek -ile.  
 2sg.s- PST-AUX 2sg.s-cook -FS.PST  
 'You had cooked.'

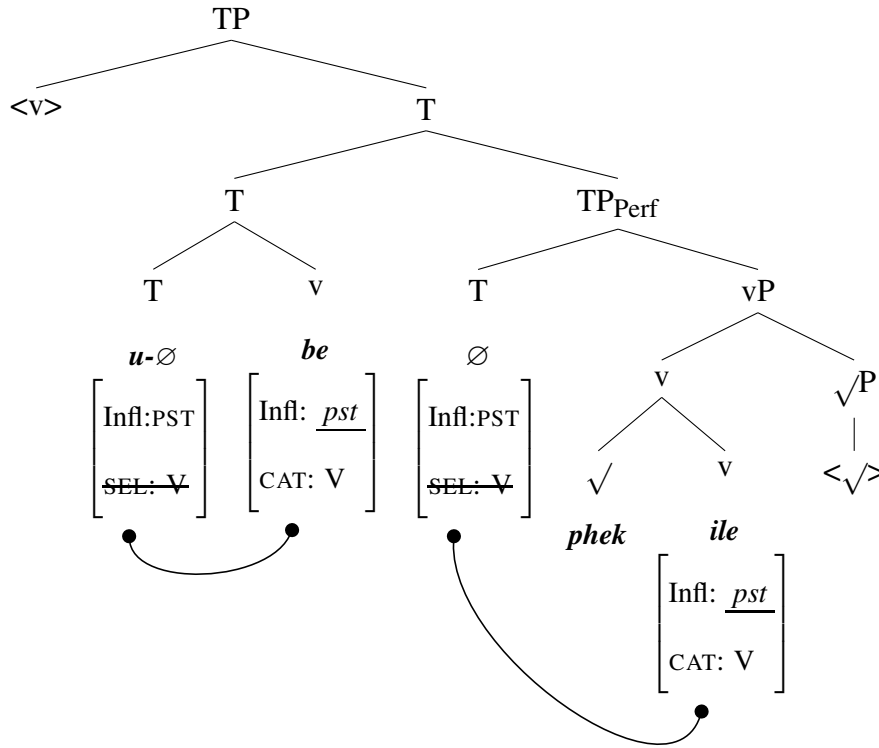

(66) Past Prospective (periphrasis)

U- ∅-be u- za- phek -a.  
 2sg.s- PST-AUX 2sg.s- FUT- cook -FS.FUT  
 'You were going to cook.'

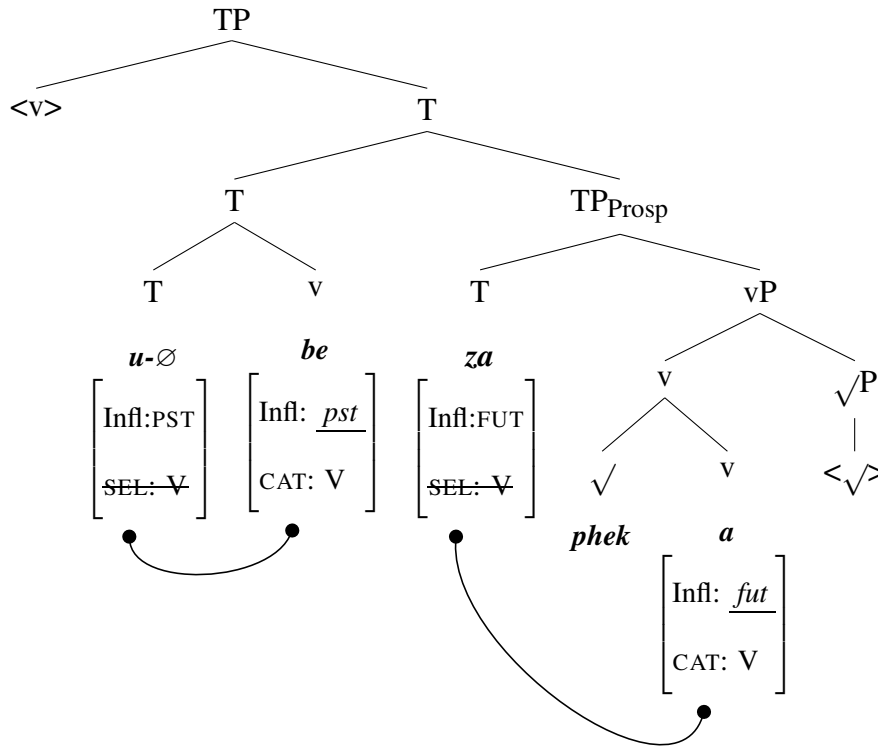

To conclude, the interaction of tense features in Ndebele provides additional evidence for the overflow distribution of default auxiliaries in this language. The appearance of an auxiliary is not tied to a specific inflectional category, such as perfect aspect. We have seen that both perfect and prospective aspect may be expressed synthetically if they do not cause an inflectional overflow. An inflectional overflow can only be calculated more globally than just by looking at one head – it is determined by an interaction of inflectional heads, for example of two Ts. As such, it lends support to the Insertion approach, according to which auxiliary verbs are inserted derivationally, and not base generated (either as lexical or functional verbs).



## 4.5 Against configurational approaches to the Failure Question

The analysis proposed in the previous section relates the failure of synthesis to inflectional overflow. In particular, the answer I give to the Failure Question is the following: an inflectional head cannot combine with a verb when the head has an Infl-value to share but the verb does not have an unvalued Infl-feature. In other words, a head with an Infl-value cannot combine with a verb that also has an Infl-value. I call this type of approach *a feature conflict approach* to the failure question. This particular implementation of feature conflict was inspired by Cowper's (2010) analysis of English auxiliaries and amended in such a way that it can also apply to the overflow pattern (by weakening the activity condition). Another implementation of the feature conflict view of synthesis failure can be found in Arregi & Klecha (2015), who propose a constraint against more than one inflectional feature on a single head.

A different type of answer to the Failure question was given in Arregi (2000), Embick (2000) and Bjorkman (2011). These authors define the failure of synthesis in configurational terms. Arregi (2000) and Embick (2000) proposed that synthesis requires head movement of the verb to the inflectional head it synthesizes with. In Bjorkman's view, the extent of verb movement necessary for synthesis is to the head immediately below the one it is to synthesize with. In this section, I discuss configurational approaches and argue the feature conflict approach fares better, both theoretically and empirically. In section 4.5.1, I discuss the answer to the Failure Question proposed by Bjorkman (2011), which relies on two mechanisms: Infl-agreement and head movement. In section 4.5.2, I consider the proposal according to which synthesis failure is directly related to head movement (Arregi, 2000; Embick, 2000).

### 4.5.1 *Head-movement and Infl-agreement (Bjorkman, 2011)*

Bjorkman proposes a system in which synthesis and periphrasis are regulated by two aspects of derivation: Infl-agreement and head-movement. First, Bjorkman assumes that inflectional heads (except for the highest one) have both a valued and an unvalued Infl-feature. Thus, Infl-agreement

holds not only between verbs and inflections, as in the analysis proposed here, but also between inflectional heads. In effect, Infl-values are transmitted one head down, as illustrated in (67).

(67) Infl-agreement (Bjorkman, 2011)

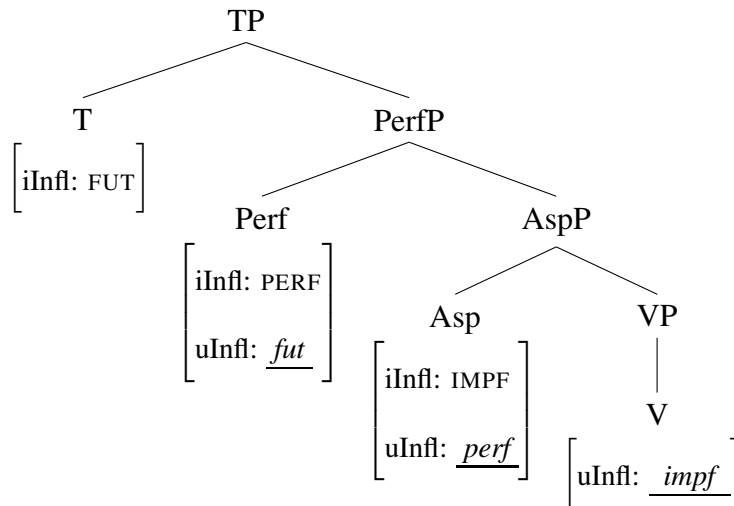

The condition on synthesis in Bjorkman’s account is that every uInfl (but not iInfl) be in a complex head with a verb. A uInfl that’s not in a complex head with a verb triggers auxiliary insertion. Thus, periphrasis in Bjorkman’s system is regulated by head-movement, since head-movement brings the verb to be part of a higher complex head. In the structure in (67), the minimal amount of head movement necessary for a synthetic expression is to Perf – this is where the highest uInfl is located. Head-movement all the way to T would also result in synthesis. Head movement only to Asp will result in auxiliary insertion in Perf, while no head movement at all additionally causes auxiliary insertion in Asp.

I discuss two issues with Bjorkman’s approach to the Failure Question outlined above. The first problem is empirical: it incorrectly predicts that functional verbs such as aspectual auxiliaries in Ndebele should sometimes bleed auxiliary insertion. The second issue concerns the role of head movement: the claim that periphrasis is a function of head movement is empirically unmotivated.

Recall the analysis of aspectual auxiliaries proposed in the previous chapter. I argued that they are verbal elements associated with particular inflectional heads and host valued Infl-features

specific to the inflectional head they appear in. Take for instance the aspectual auxiliary verb *se* ‘already’, associated with the perfect aspect. According to the present proposal, the category of *se* is a V of level 4 – the level of perfect aspect in the extended projection (68).

- (68) Asp-auxiliary *se* ‘already’
- |       |           |
|-------|-----------|
| SEM:  | ‘already’ |
| CAT:  | ⟨V,4⟩     |
| Infl: | PST       |

As shown again in (69), *se* takes a past participle as its complement (in the absence of an imperfective Asp head; see section chapter 3, section 3.2).

- (69) U-*se*            u-phek-ile.  
 2sg.s-already 2sg.s-cook-FS.PST  
 ‘You have already cooked’

Given the high position of *se*, Bjorkman’s analysis predicts that this aspectual auxiliary should support tense inflection. This is because the uInfl-feature on Perf is now in the same complex head as the auxiliary verb (70).

- (70) Infl-agreement (Bjorkman, 2011)

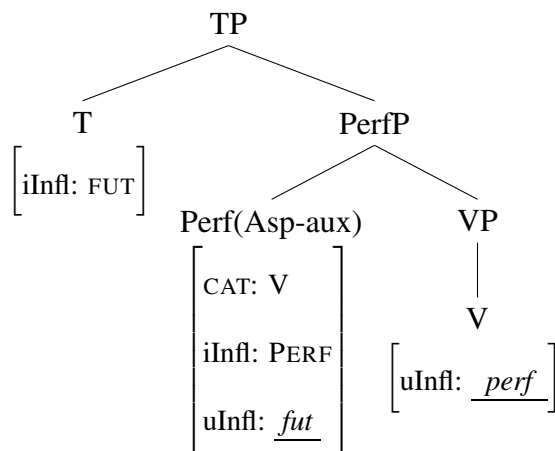

Given that both uInfl-features in (70), the one on Perf and the one on V, are in a complex head with a verbal element (either the main verb or an auxiliary verb), Bjorkman predicts that the aspectual auxiliary in Perf should bleed default auxiliary in Perf. This prediction is, however, incorrect. Future tense inflection cannot combine with *se* synthetically, as evident from the ungrammaticality of (71-a). Instead, future tense must be supported by a default auxiliary, just like it does when Perf is verbless (71-b).

- (71) a. \*U-za-se            u-phek-ile.  
           2sg.s-FUT-already 2sg.s-cook-FS.PST  
           ('You will have already cooked')
- b. U-za-be            u-se            u-phek-ile.  
           2sg.s-FUT-AUX 2sg.s-already 2sg.s-cook-FS.PST  
           'You will have already cooked'

Similarly, past tense with *se* can only be expressed periphrastically, as the pair in (72) shows.

- (72) a. \*U-a-se            u-phek-ile.  
           2sg.s-DPST-already 2sg.s-cook-FS.PST  
           ('You had already cooked')
- b. U-a-be            u-se            u-phek-ile.  
           2sg.s-DPST-AUX 2sg.s-already 2sg.s-cook-FS.PST  
           'You had already cooked'

The fact that the aspectual auxiliary *se* does not act like a support verb suggests that periphrasis is not triggered the absence of a local verbal element – *se* in (70) is in the right position to support tense inflection – but rather by the fact that *se* has a valued Infl-feature. This is what differentiates the aspectual auxiliary from a lexical verb in the same position. Thus, the inability of tense to synthesize with *se* points to the conclusion that the answer to the failure question must be related to the notion of feature conflict, rather than to locality.

Indeed, the analysis proposed here derives the attested pattern of periphrasis in aspectual verb constructions. I illustrate with Future Perfect, for comparison with (70). T<sub>Perf</sub> is verbal – it hosts

the aspectual auxiliary *se*. Therefore, it has a [CAT:V] and no [SEL:V] feature. But as a perfect aspect head, it has [Infl:PST], which is transmitted onto the main verb by agreement.

(73) Future Perfect with the auxiliary *se* ‘already’

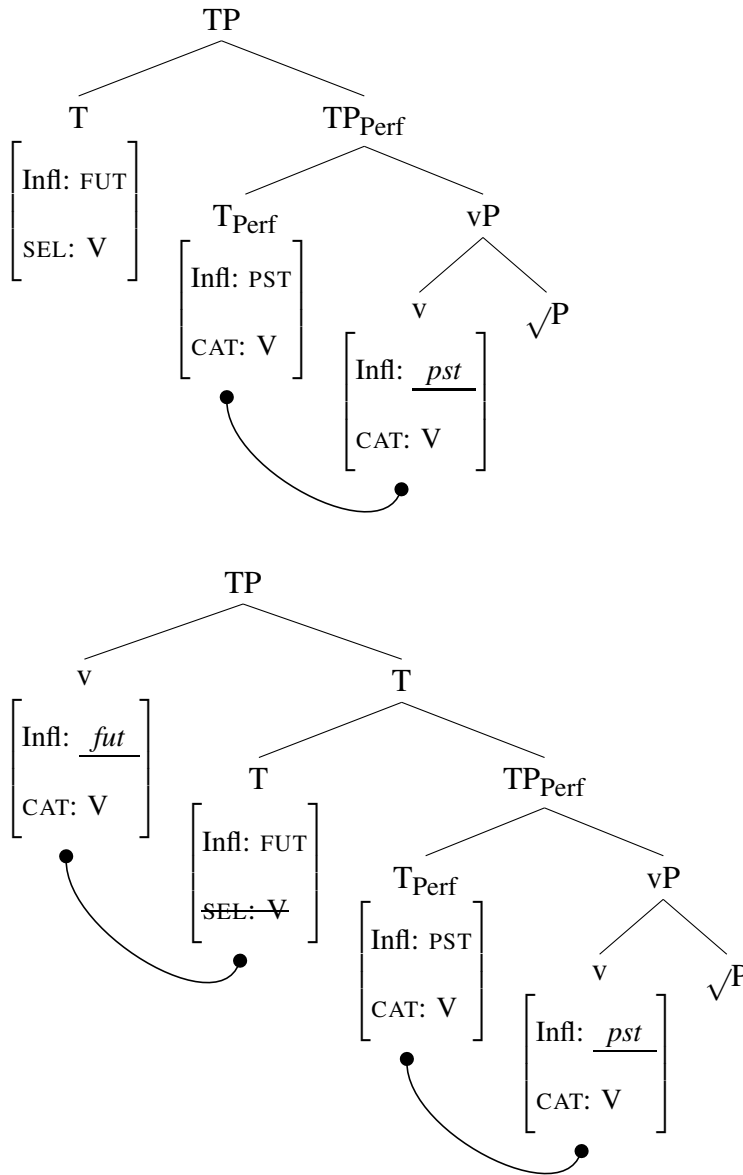

When T is merged, it must find an active category goal to check its selectional V-feature. However, the aspectual verb is not active (its Infl-feature is valued), and at this point the main verb’s Infl-feature is also valued (by the more local T<sub>Perf</sub>). Consequently, the selectional feature of

T remains unchecked and triggers merge of an expletive verb – the default auxiliary. The derivation of past tense with *se* proceeds in the same way.

This analysis correctly predicts that an aspectual verb such as *se* may only appear without a default auxiliary in the present tense since the present tense in Ndebele is unmarked and therefore no feature conflict arises between T and T<sub>Perf</sub>. We have already seen an example of Present Perfect with *se* in (69), and I repeat it in (74) below.

(74) U-se            u-phek-ile.  
 2sg.s-already 2sg.s-cook-FS.PST  
 ‘You have already cooked’

(75) Present Perfect with the auxiliary *se* ‘already’

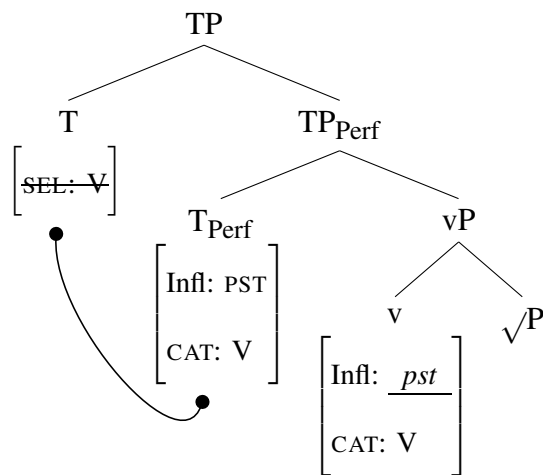

Since present tense in Ndebele is unmarked, T in (69) only has a selectional V-feature. Perfect aspect has a category V feature and a valued Infl-feature (Infl:PST). Thus, the syntax of (69) is the same as the syntax of a regular present perfect tense, the difference being that T<sub>Perf</sub> is occupied by an aspectual auxiliary verb. The proposed analysis of periphrasis, based on feature conflict (implemented as an activity condition an V-checking), correctly derives the fact that a present tense T can combine with aspectual auxiliaries synthetically.

Aspectual auxiliaries associated with imperfective aspect show the same behavior: they cannot combine with marked tense synthetically, and can appear without an auxiliary only in the present

tense.

(76) *lokhe* ‘still’ + past tense ⇒ periphrasis

- a. \*U-a-lokhe        u-phek-a.  
2sg.s-DPST-still 2sg.s-cook-FS.IMPF  
(‘You were still cooking’)
- b. U-a-be            u-lokhe u-phek-a.  
2sg.s-DPST-AUX 2sg.s-still 2sg.s-cook-FS.IMPF  
‘You were still cooking’

(77) *lokhe* ‘still’ + future tense ⇒ periphrasis

- a. \*U-za-lokhe     u-phek-a.  
2sg.s-FUT-still 2sg.s-cook-FS.IMPF  
(‘You will still be cooking’)
- b. U-za-be         u-lokhe u-phek-a.  
2sg.s-FUT-AUX 2sg.s-still 2sg.s-cook-FS.IMPF  
‘You will still be cooking’

(78) *lokhe* ‘still’ + present tense ⇒ synthesis

U-∅-lokhe        u-phek-a.  
2sg.s-PRES-still 2sg.s-cook-FS.IMPF  
‘You are still cooking’

(79) *hlezi* ‘constantly’ + past tense ⇒ periphrasis

- a. \*U-a-hlezi                u-phek-a.  
2sg.s-DPST-constantly 2sg.s-cook-FS.IMPF  
(‘You constantly cooked’)
- b. U-a-be            u-hlezi            u-phek-a.  
2sg.s-DPST-AUX 2sg.s-constantly 2sg.s-cook-FS.IMPF  
‘You constantly cooked’

(80) *hlezi* ‘constantly’ + future tense ⇒ periphrasis

- a. \*U-za-hlezi                u-phek-a.  
2sg.s-FUT-constantly 2sg.s-cook-FS.IMPF  
(‘You will constantly cook’)

- b. U-za-be            u-hlezi            u-phek-a.  
 2sg.s-FUT-AUX 2sg.s-constantly 2sg.s-cook-FS.IMPF  
 ‘You will constantly cook’

(81) *hlezi* ‘constantly’ + present tense ⇒ synthesis

- U-∅-hlezi            u-phek-a.  
 2sg.s-PRES-constantly 2sg.s-cook-FS.IMPF  
 ‘You constantly cook’

The pattern of periphrasis with *lokhe* and *hlezi* is derived the same way periphrasis with *se* is derived. They are verbal elements with a valued Infl-feature (this time Infl:IMPF) and they cannot check the selectional V-feature on T if T is marked (i.e. non-present).

The second issue with the configurational approach to the Failure Question is its reliance on head-movement. As discussed at the beginning of this section, head movement plays a crucial role in deriving the distribution of periphrasis in Bjorkman’s system. Under this view, we expect to observe crosslinguistic tendencies for periphrasis in languages with no or little head movement of the verb, and less or no periphrasis in languages in which the verb moves to a high position. For instance, this view would gain credibility if English and French had different patterns of auxiliary use. Since in English there is no V-to-T movement, we would expect more analytic tenses than in French, where the verb moves to T. In fact, we would expect no compound tenses in French given that the verb moves all the way to T. This is not true. French does have verbal periphrasis, and in a very similar distribution as in English.<sup>8</sup> Consider, for instance, periphrastic tenses arising from the

---

8. There is a way in which English has more periphrastic forms than French: English has do-support. Indeed, the presence of do-support in English and its absence in French are traditionally viewed as a consequence of V-to-T movement in French but not in English. However, do-support is a different type of periphrasis than the type discussed here, the type involved in what we call compound tenses. Most importantly, do-support is not triggered by inflectional complexity. For instance, there is no obvious sense in which an object wh-question, which requires do-support (i), is inflectionally more complex than a subject wh-question, which does not (ii).

- (i) Who **do** you know?  
 (ii) Who knows you?/\*Who **does** know you?

Moreover, even do-support cannot be seen as being a direct consequence of the lack of head movement. In English,



interaction of tense and passive voice (which in English and French is an Infl-feature interacting with periphrasis, unlike in Ndebele).

(82) Past passive in French and English

- a. Le livre **était** lu. (Bjorkman, 2011:98)  
The book be.PST read.PTCP
- b. The book **was** read.

The fact that both languages require an auxiliary to support tense in passive voice would suggest, under the configurational approach, that neither French nor English has verb movement to T. Given independent evidence for V-to-T movement in French, we must stipulate that such movement takes place only in active voice. This is indeed Bjorkman's analysis. To account for periphrasis in passive clauses in French, and in fact for all other compound tenses, Bjorkman posits head movement rules which apply in different inflectional contexts. The rules necessary to derive passive and perfective compound tenses in French are listed in (83).

(83) Head movement in French (Bjorkman, 2011)

- a. V to T  
b. Asp-to-T  
c. Voice-to-T  
d. no V-to-Voice  
e. no V-to-Asp

---

the main verb never moves to T, but simple tenses are typically synthetic – "do" appears only in certain contexts, e.g. with negation. Thus, its appearance has to do with constraints on synthesis of V and T in languages without V-to-T movement (e.g. Affix Hopping (Chomsky, 1957) or morphological merger under adjacency (Bobaljik, 1994)). The picture is further complicated by languages like Swedish or Danish, in which neither V-to-T movement nor do-support occurs. (Mainland Scandinavian languages have do-support only if the main verb is absent, i.e. in VP ellipsis, fronting and prominalization.) Leaving the question of do-support and its relation to head movement aside, its presence in English does not constitute a correct prediction of the head-movement approach to the Failure Question in inflectional periphrasis. This is because do-support is not an instance of inflectional periphrasis triggered by inflectional complexity.

- f. Voice and Asp are skipped by V if unmarked (active and imperfective, respectively)

Given the rules in (83), the derivation of the passive sentence in (82-a) proceeds as shown in (84).

V does not move to Voice and Voice moves T.

- (84) French: past imperfective passive (Bjorkman, 2011)

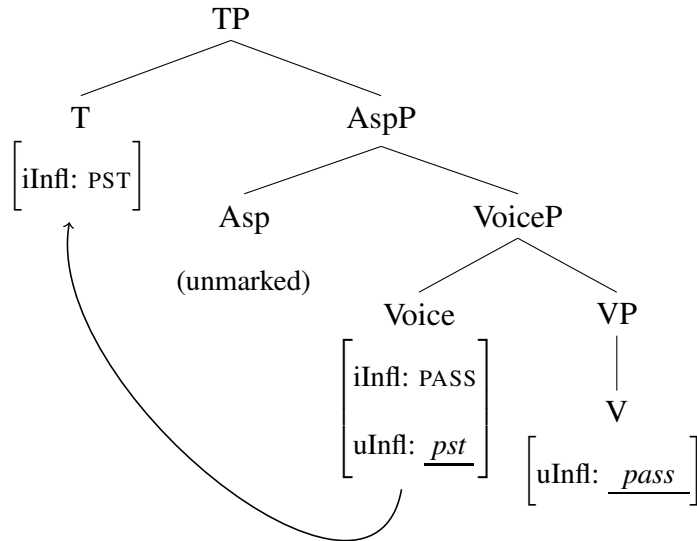

The uInfl on the verb is in a complex head with verb, but uInfl on Voice is not in a complex head with a verb and therefore an auxiliary must be inserted (the auxiliary surfaces in T due to Voice-to-T movement but that's irrelevant for periphrasis). Note that Voice does not move through Asp, as we would expect it to given the Head Movement Constraint (Travis, 1984). This is because Asp has no Infl feature and, according to Bjorkman, Infl-agreement is necessary to license head movement. This means that in an imperfective active sentence, i.e. when both Voice and Asp are unmarked, V moves directly to T.

To be clear, Bjorkman's account is not empirically wrong. There is no evidence, as far as I can tell, that the rules in (83) are incorrect. The objection is a theoretical one. There is no independent evidence for these particular rules – the only motivation for claiming head movement in French

works according to those rules in the distribution of periphrasis. As such, this analysis does not *derive* the distribution of auxiliaries in French. Rather, their distribution is stipulated in the form of head movement rules.

Note that a feature conflict account, like the one proposed here, does not rely on head movement in any way. If two languages differ in the distribution of head movement, but have the same inflectional features, it predicts the same pattern of periphrasis. That is, we correctly predict that English and French passive sentences will behave the same.

(85) Past passive in French and English (Asp unmarked)

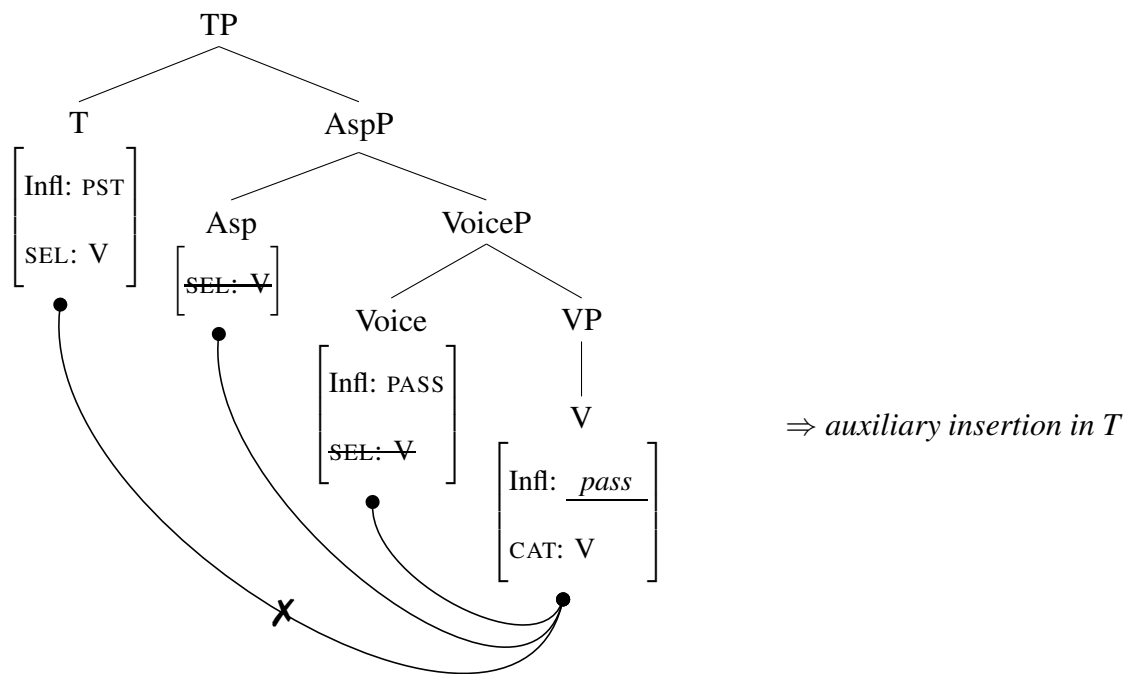

The selectional features which can be checked by the main verb in (85) are Voice and Asp. Voice is subject to the activity condition (it has an Infl-feature) and the verb is active when Voice is merged. Asp, on the other hand, is unmarked and therefore not subject to the activity condition on V-checking. T, on the other hand, is marked and there is no active category goal to check its selectional feature. As a result, a default auxiliary must be merged with T. The derivation proceeds

exactly the same way in English and in French. The fact that the two languages differ with respect to head movement is irrelevant under this account since periphrasis arises due to a feature conflict, not due to the lack head movement.

A possible objection to the view of periphrasis as insensitive to head movement would be the fact that it seems to make no predictions at all about how head movement and periphrasis interact. For instance, does the present analysis allow movement of the main verb in (85) (i.e. the passive participle) to T? This would cause the main verb and the auxiliary to be in the same complex head. The answer is no – the main verb cannot move to the a head that is supported by an auxiliary. I address this question at the end of this section, where I discuss the relation between c-selection and head-movement. Before that, let me discuss a different configurational approach to the Failure Question.

#### *4.5.2 Lack of head movement triggering auxiliary insertion*

A different configurational requirement for synthesis was proposed by Arregi (2000) for Basque and by Embick (2000) for Latin. These authors argue that auxiliary insertion in these languages is triggered in an inflectional head which is not reached by head movement of the verb. That is, verb movement to F is necessary for F and the verb to be expressed synthetically.

This type of account has advantages over Bjorkman's analysis. First, it derives periphrasis from head movement exclusively. There is only one relation combining verbs with inflections, head movement, and not two, like in Bjorkman's account (head movement and Infl-agreement). And second, it does not make the incorrect prediction that aspectual verbs in Ndebele should support tense inflection. This is because they are located in Perf and Asp, and synthesis with tense requires a verb in T. However, the general objection to positing a causal relation between the extent of head movement and synthesis/periphrasis holds for these accounts as well. If the head-movement requirement these authors posit for the respective languages were to be treated as a universal condition on synthesis, the same question arises about the lack of difference between



(87) Latin synthetic tenses with passive voice (no perfect aspect): **passive + tense**

- a. amor  
love.1sg.PASS.PRES  
'I am loved'
- b. amabar  
love.1sg.PASS.PST  
'I was loved'

(88) Latin synthetic tenses with perfect aspect (active): **perfect + tense**

- a. amavi  
love.1sg.PERF.PRES  
'I have loved'
- b. amaveram  
love.1sg.PERF.PST  
'I had loved'

Recall that, in Embick's view, synthesis is only possible if the verb moves to the relevant inflectional head. To account for the distribution of auxiliaries in Latin, Embick proposes that head movement in this language works according the following rules (89).

(89) Head movement in Latin (Embick, 2000)<sup>10</sup>

- a. v always moves to Asp
- b. Asp normally moves to T, but
- c. Asp doesn't move to T if it is perfective and contains the feature [pass] (from the v that moved to it)

The last rule captures the fact that perfective aspect cooccurring with passive voice must be periphrastic. Let us first see the derivation of synthetic tenses, that is where either Asp is perfective or Voice is passive, but not both. Notice that the value of tense does not play a role in regulating

---

10. Bjorkman's analysis of Latin is in the same spirit, though, given the different condition on synthesis, the head movement rules proposed for Latin by Bjorkman are different: there is not movement to T, V always moves to Voice and Asp (directly), but there is no head movement of Voice to Asp.

periphrasis. (The passive is a feature of v, not Voice, in Embick's analysis; and the lexical root always moves to v.)

(90) **passive + tense**  $\Rightarrow$  synthesis (87)

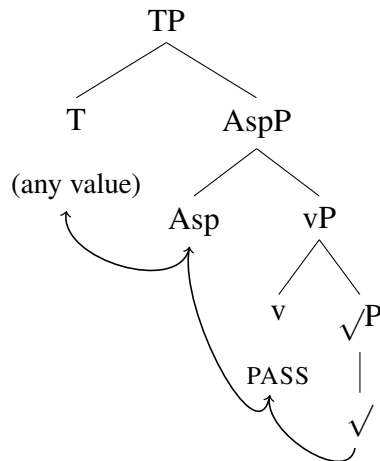

(91) **perfect + tense**  $\Rightarrow$  synthesis (88)

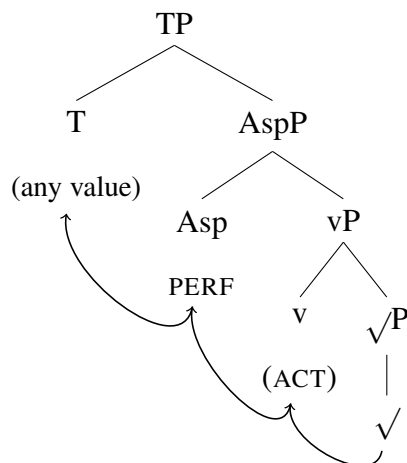

If v is passive it may move to perfective Asp, but according to the constraint in (89-c), this head cannot move further to T and auxiliary insertion is triggered in T. (92) is the derivation of periphrastic tenses in Latin.

(92) **passive + perfect + tense**  $\Rightarrow$  periphrasis (86)

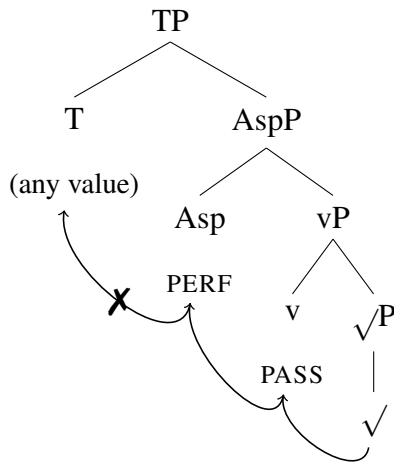

This analysis is subject to the same objection as Bjorkman’s analysis of French: the distribution of auxiliary verbs is restated as head movement rules. As such, this analysis does not offer an understanding of why periphrasis occurs with increased inflectional complexity crosslinguistically. Note that this generalization is true for the Latin paradigm as well. Since passive is typically the marked value of Voice/v, it is not surprising that passive structures are more often periphrastic than active sentences. This generalization is, however, not captured by Embick’s analysis, which relies solely on the statements in (89). In principle, there is no reason why the rule in (89-c) does not refer to active voice instead, which would then make active structures more prone to periphrasis than passive ones. It remains to be seen if there are languages with synthetic passives but periphrastic active voice.

The feature conflict account I develop has the potential of deriving the fact that the inflectionally more complex passive structures fail to be expressed synthetically more often than active ones. Suppose that passive is a marked value of Voice (like in English and French), and that perfective is the syntactically marked Aspect (imperfective being unmarked). Tense, on the other hand, is always fully specified. The featural composition of the three inflectional heads in Latin is shown in (93).<sup>11</sup>

---

11. The same featural composition of inflectional heads in Latin was proposed by Bjorkman 2011.



- (93) a. T [Infl:PST/FUT/PRES]  
 b. Asp ([Infl: PERF]) (imperfective unmarked)  
 c. Voice: ([Infl:PASS]) (active unmarked)

If we think about the Latin paradigm of compound tenses in terms of feature conflict and inflectional complexity, a simple generalization emerges: the Latin verb can host two inflectional features, whatever they are. The analysis I proposed for Ndebele can derive the Latin data if we allow verbs in some languages to have two unvalued Infl-features. That is what I propose: the Latin verb has two unvalued Infl-features and therefore stays active for V-checking until it is valued twice. Thus, periphrasis only arises when all three inflectional categories, T, Asp and Voice, are marked. The derivations in this account are given below. (94) shows the derivation of a synthetic expression whenever voice is active (unmarked). (95) is the derivation with unmarked aspect (imperfective), and (96) is a case where all three heads have an Infl-feature, giving rise to auxiliary insertion in T caused by T's unchecked selectional feature. (In all examples the value of T is PST, but this choice has no consequence for the derivation since all tenses in Latin are fully specified and so they equally contribute to periphrasis.)

(94) Voice unmarked (active): synthesis

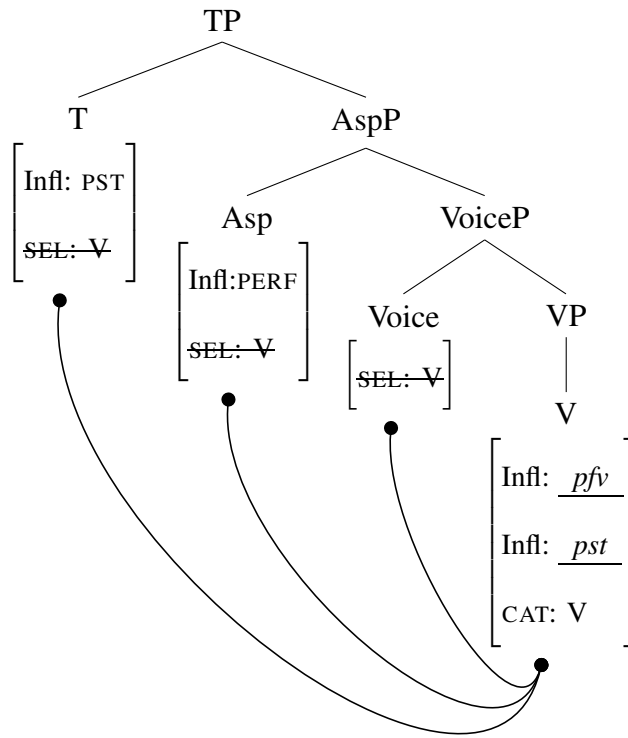

(95) Asp unmarked (imperfective): synthesis

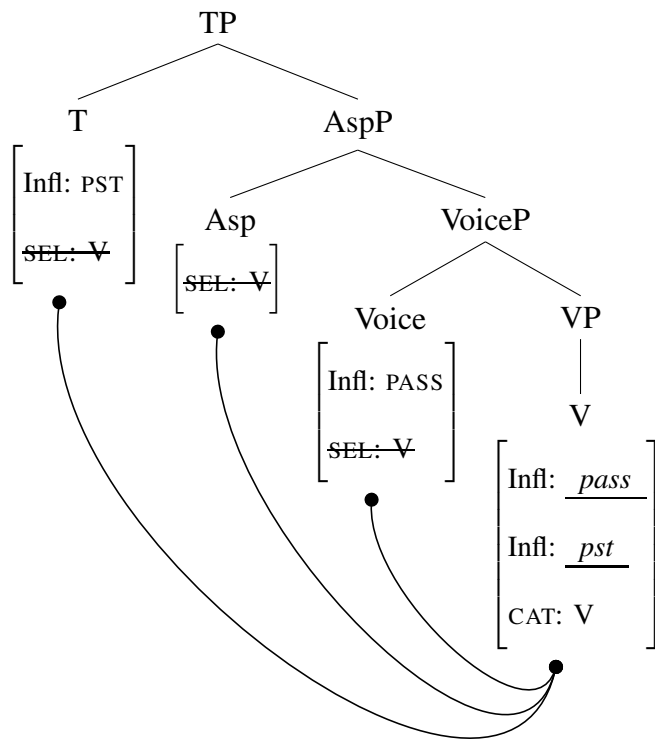

(96) All three categories marked: periphrasis

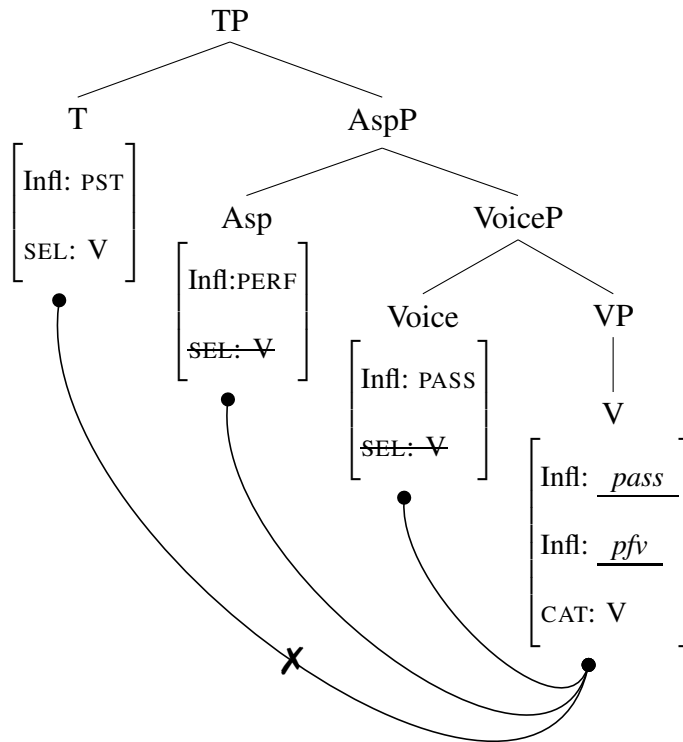

Like with French and English, this account of the Latin facts does not make reference to head movement. It focuses instead on the featural complexity of the inflectional domain, which it turn allows it to account for the crosslinguistic generalization that periphrasis is triggered by increased inflectional complexity. This generalization is not captured by an account of periphrasis in terms of language specific head movement rules.

Finally, it should be noted that the hypothesis that periphrasis arises due to the lack of head movement cannot be thought of as a universal property of the grammar. This is due to the existence of languages like English, in which the absence of V-T movement does not prevent e.g. simple past from being a synthetic tense. Thus, the connection of periphrasis to head movement is not nearly as robust as its sensitivity to inflectional complexity.

Is there no relation between head movement and periphrasis, then? I believe there is no causal relation, one way or the other. Featural complexity can trigger periphrasis in a language with any amount of head movement in the inflectional domain. However, there appears to be one generalization about how the two interact. Auxiliary insertion in head H and head movement to the same head H are in complementary distribution. Abstracting away from auxiliary clitics (such as those found in some Slavic languages (Borsley & Rivero, 1994; Migdalski, 2006)) this generalization seems to hold robustly. However, there is no reason to think of this complementary distribution as being an effect of a *causal* relation between head movement and periphrasis. Instead, I argue that it is a side effect of how head movement and periphrasis are triggered, independently of each other.

I suggested earlier in this chapter that the selectional V-feature on inflectional heads is a feature which triggers merge, internal or external (following earlier proposals in this vein (Svenonius, 1994; Holmberg, 2000; Julien, 2002; Matushansky, 2006)). As such, the V-feature is responsible for both head movement (internal merge) and auxiliary insertion (external merge). Which one it will be depends on the inflectional context; in particular on whether it can access the main verb (as explained in the mechanism of periphrasis) and whether it is a strong feature (triggering movement) or not. Thus, there are three ways in which a selectional V-feature can be checked. First, the head H checks its V-feature against the main verb, as we've seen it in synthetic tenses in Ndebele (97). The second scenario is the same except the selectional feature is strong, triggering internal merge of the verb (98). And the third is periphrasis, i.e. when H cannot assess the main verb and its selectional V-feature triggers external merge of an auxiliary (99).

(97) Synthesis; no head movement

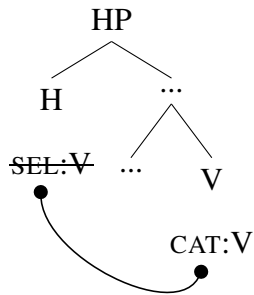

(98) Synthesis; head movement

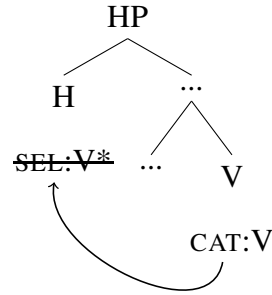

(99) Periphrasis

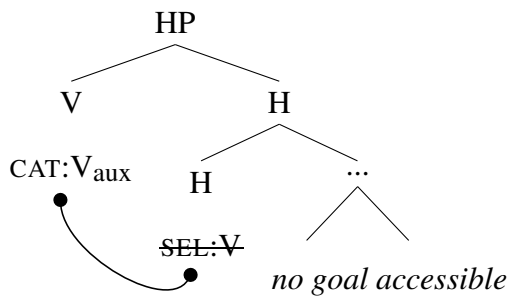

The hypothesis about how head movement and periphrasis interact captures all the observations we have made about it. A lack of head movement does not entail periphrasis because the V-feature may be checked without triggering head movement (English simple tenses, (97)). For the same reason, we do not expect English and French to have different patterns of periphrasis: the difference between them is the difference between (97) and (98), which are both synthetic scenarios. Finally, auxiliary insertion in H and head movement of the verb to H are in complementary distribution because (98) and (99) are two alternative ways of checking a selectional V-feature (by internal or external merge). Their complementary distribution is not the effect of a clausal relationship between them, but a natural consequence of Cyclic Selection.

## 4.6 Conclusion

In this chapter, I proposed an analysis of default periphrasis in Ndebele, adopting the Insertion approach. The main empirical argument for the Insertion approach to periphrasis in Ndebele is the existence of the overflow pattern of auxiliary use (Bjorkman, 2011), where default auxiliaries are not associated with specific inflectional heads (unlike aspectual auxiliaries), but their appearance is triggered by inflectional complexity. In this approach to periphrasis, auxiliary insertion is viewed as a repair strategy which, informally speaking, applies when an inflectional category cannot combine with the main verb. One of the goals in this chapter was to understand exactly why inflections cannot combine with verbs (the Failure Question) and why the repair of such failure is auxiliary insertion (the Repair Question). I argued that the answer to the Repair Question does not need to be stipulated (as a morphological or a syntactic insertion rule applying to what is defined as stranded inflection). The appearance of an extra verb in the structure falls out as a natural property of such stranded inflections if we assume that the mechanism combining inflections with verbs is c-selection, modeled as Cyclic Selection. I additionally argued that default periphrasis should be treated as a derivational phenomenon, directly sensitive to inflectional complexity and not mediated by head movement. There is no independent evidence that head movement regulates periphrasis, and accounts in this vein essentially rephrase the distribution of periphrasis in different languages in the form of language-specific head-movement rules. Since the head-movement rules are not related to inflectional complexity in a principled way, the robust sensitivity to inflectional periphrasis is accidental under these approaches to the Failure Question.

The proposed Insertion approach to default periphrasis provides a specific understanding of default auxiliaries as non-projecting verbs. As with aspectual auxiliaries, the non-projecting property of a default auxiliary is due to its category level specification. While aspectual auxiliaries' limited projection is a consequence of a high, functional category level, default auxiliaries have the category level 0, and for this reason they cannot have an extended projection (they cannot be targeted by HoP merge). The only way for a default auxiliary verb to enter the derivation is to be c-selected,

i.e. by Sel-Merge. In sum, I have argued that both types of auxiliary verbs in Ndebele are non-projecting verbs, though they fall under different types of non-projection approaches (the FP approach to aspectual auxiliaries and the Insertion approach to default auxiliaries). The VP-approach has proved inadequate for both auxiliary types. The next chapter is concerned with another multi-verb construction, which superficially might look like a candidate for the VP approach. I show, however, that this third type of light verb is, morphosyntactically, a regular projecting lexical verb.



## CHAPTER 5

### LEXICAL LIGHT VERBS AND SELECTION

#### 5.1 Introduction

We concluded in the previous chapter that default auxiliaries are merged via last-resort selection, while aspectual auxiliaries are merged as functional heads. As such the two auxiliary-verb types instantiate different approaches to auxiliary verbs in general: the Insertion approach and the FP approach, respectively. In this chapter, I further argue that none of those two types of auxiliaries is an instance of a third existing approach: the VP approach. The argument is based on the existence of a third type of monoclausal multi-verb construction in Ndebele involving auxiliary-like verbs which *do* project a VP. Crucially, such *lexical light verbs* show different properties than default or aspectual auxiliaries, suggesting that the latter two types of light verbs are not verbs licensing extended projections. I focus on comparing lexical light verbs with aspectual auxiliaries (or *functional light verbs*) – and provide evidence that they do not form a uniform class. Importantly, lexical light verbs are *not* an instance of a construction which could be analyzed under the VP approach, either. They do project a VP, but they are not auxiliary verbs by any reliable syntactic measure. Even though their semantics resembles the meanings of aspectual auxiliaries, lexical light verbs are regular lexical verbs which can project full clausal structure. As such, they do not fit in the profile of a minimally projecting verb assumed for auxiliaries under the VP approach. The emerging conclusion is that none of the three multi-verb constructions in Ndebele provides evidence for the existence of verbal elements of the kind hypothesized in the VP approach.

The new class of LVs differs from aspectual auxiliaries in the morphology of the selected verb: they combine with subjunctive forms, rather than with participles. Subjunctive-selecting light verbs are listed in (1) and illustrated in (2).

- (1) Subjunctives-selecting light verbs
- a. *mane* – just/simply do
  - b. *ke* – do at some point/sometimes
  - c. *phinda* – do again
  - d. *qala* – do first
  - e. *hle* – do immediately/right away
  - f. *ze* – finally/eventually do
  - g. *phose* – almost do
- (2)
- a. Ngi-**mane** ngi-pheke.  
1sg.s-just 1sg.s-cook.SBJV  
I just cook.
  - b. Ng-ya-**ke** ngi-pheka.  
1sg.s-PRES-someT 1sg.s-cook.SBJV  
'I sometimes cook'
  - c. Ngi-za-**phinda** ngi-pheke.  
1sg.s-FUT-again 1sg.s-cook.SBJV  
'I will cook again'
  - d. Ngi-**qala** ngi-pheke.  
1sg.s-first 1sg.s-cook.SBJV  
'I first cook (before doing anything else)'
  - e. Ngi-za-**hle** ngi-pheke.  
1sg.s-FUT-right.away 1sg.s-cook.SBJV  
'I will cook right away'
  - f. Ngi-za-**ze** ngi-pheke.  
1sg.s-PST-right.away 1sg.s-cook.SBJV  
'I will finally cook'
  - g. Ngi-**phose:** nga-pheka.  
1sg.s-almost.PST 1sg.s-cook.PST.SBJV  
I almost cooked.

Participle- and subjunctive-selecting light verbs are often thought of a single class, called *adverbial auxiliaries* or *deficient verbs* (Khumalo, 1981; Slattery, 1981). The common denominator underly-

ing this classification has been largely semantic – the meanings they express are of a similar kind. Roughly speaking they express meanings encoded by adverbs in Indo-European languages. Under a unified treatment of the two classes of light verbs, the form of the main verb (participial or subjunctive) is viewed as a selectional property of a particular light verb: some adverbial auxiliaries select for a participle and others for a subjunctive complement (Slattery, 1981). I argue in this chapter that the selected forms need not be stipulated lexically and that they correlate with independent syntactic asymmetries between the two types of light verbs. In particular, I propose that subjunctive selecting light verbs are lexical verbs. Thus, they contrast with participle-selecting light verbs, which I argued to be functional verbs. We will see morphosyntactic evidence that participle- and subjunctive-selecting light verbs should not be treated as a uniform class, despite their semantic affinity. The morphology of their complement falls out from the light verb's status as functional or lexical. The proposed structure of lexical light verbs is shown in (3). Unlike functional light verbs, which spell out functional heads in the main verb's extended projection (4) (i.e. are verbs of higher, functional levels), lexical LVs are of category  $\langle V, 1 \rangle$ , like any lexical verb, and project a full extended projection of their own.

(3) Lexical LVs:

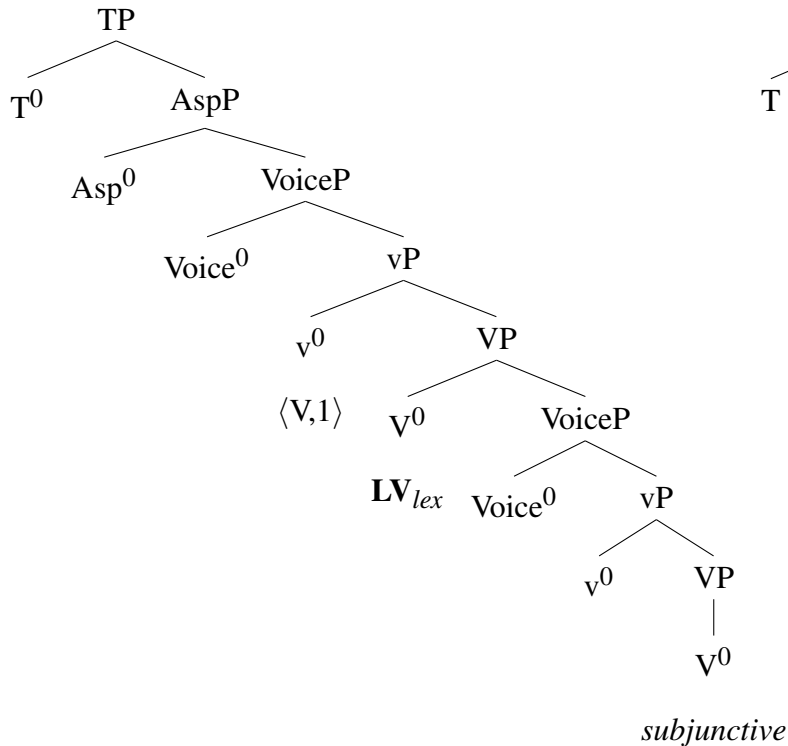

(4) Functional LVs (aspectual auxiliaries):

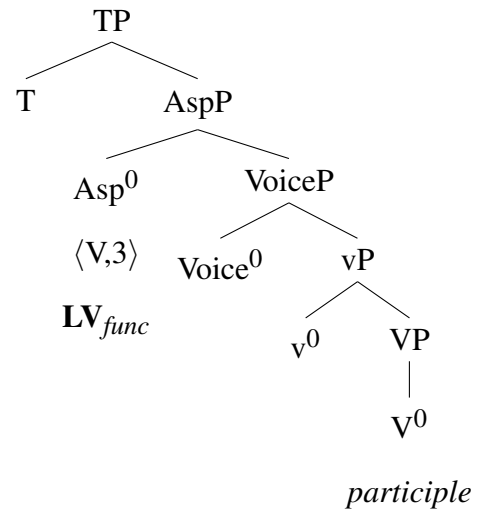

The next section provides evidence for the syntax of lexical-LV constructions proposed in (3). First, I review a range of morphosyntactic asymmetries between participle- and subjunctive-selecting light verbs, and argue that they support the functional–lexical classification (section 5.2.1). And second, I show that the complement of lexical LVs is a reduced clausal structure, namely a VoiceP (section 5.2.2). After establishing that light verbs in Ndebele come in two types, functional and lexical, I develop an account of lexical-LV constructions which derives the selected morphology (the subjunctive form) from the lexical status of those light verbs. In particular, the main difference between functional and lexical verbs is the type of Infl-feature they host: functional LVs have a valued Infl (as discussed in chapter 3), while lexical LVs, like all lexical verbs, have an unvalued Infl-feature. This asymmetry gives rise to different configurations for Infl-agreement in the two types of LV-constructions, as shown below.

(5) Functional Light Verbs:

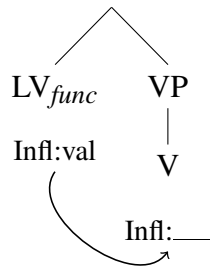

*direct valuation*  $\Rightarrow$  participle

(6) Lexical Light Verbs:

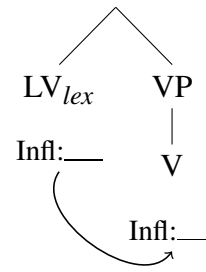

*lack of direct valuation*  $\Rightarrow$  subjunctive

The main verb morphology, participial or subjunctive, correlates directly with the minimal configurational difference sketched above. I argue that, for this reason, it should not be viewed as encoded lexically on the particular light verb.

Finally, I show a case of true idiosyncrasy within the class of lexical light verbs. Some light verbs alternate between selecting a subjunctive or an infinitive. This, I argue, is an instance of true category selection: subjunctive complements are VoicePs, while infinitives are DPs. Crucially, functional verbs never have the option to select an infinitive.

## 5.2 The syntax of lexical-LV constructions

This section is devoted to identifying a difference between participle- and subjunctive- selecting LVs, which I claim is the lexical–functional distinction. In subsection 5.2.1, I run a number of diagnostics for the lexical vs functional status of verbs and conclude that unlike participle-selecting verbs, subjunctive-selecting verbs are lexical verbs. This distinction constitutes the basic difference in the syntax the two types of LV-constructions. While participle-selecting verbs occupy a position in the extended projection of the main verb, lexical LVs (i.e. subjunctive-selecting LVs) have an extended projection of their own. For this reason, the size of a lexical LV’s complement cannot be inferred from clause structure but must be encoded as a selectional property of the light verb. I argue in subsection 5.2.2 that lexical LVs in Ndebele select for a VoiceP (or for a NegP).

### 5.2.1 *The functional–lexical dichotomy*

The functional–lexical distinction in the verbal domain has been prominent in the literature since Cinque (1998, 2001), which accounted for the evident monoclausality of restructuring contexts by treating restructuring verbs as functional heads in the extended projection of a lexical verb (Cinque, 1998, 2001; Wurmbrand, 2004; Grano, 2012). While in Cinque’s view, all restructuring verbs spell out functional heads, Wurmbrand (2004) has convincingly argued for a functional–lexical distinction among restructuring verbs in German. While some diagnostics for the lexical–functional distinction may be language specific, the three criteria in (7) are expected to apply universally in distinguishing the two types of verbs.

(7) Basic differences between functional and lexical verbs

	functional verbs	lexical verbs
thematic structure	no thematic subjects (raising)	thematic subjects possible
ordering and co-occurrence	strict and predictable	flexible
complement size and category	follows from clause structure	idiosyncratic

Assuming that the thematic domain is vP (or VoiceP), functional verbs which spell out functional heads in the higher inflectional field are predicted to be unable to have thematic arguments and therefore be necessarily raising verbs. This is naturally not true of lexical verbs, whose argument structure is projected in the VoiceP domain. Based on this difference between functional and lexical verbs, the presence of thematic arguments can be used as a diagnostic for the functional–lexical distinction. In particular, if a verb can be shown to have a thematic subject, we conclude that it is a lexical verb. I discuss this diagnostic in subsection (7) and conclude that it fails to differentiate subjunctive and participle-selecting LVs. I argue however, that the reason why lexical LVs behave the same way as functional LVs with respect to the thematic structure diagnostics is because they are lexical unaccusative verbs and not because they are also functional verbs. Their

lexical nature will become evident is other tests for the functional–lexical contrast, such as co-occurrence and ordering restrictions (subsection (23)). Functional verbs, unlike lexical verbs, are subject to strict ordering and co-occurrence restrictions, which, according to Cinque, follow from a universally fixed hierarchy of functional projections. Additionally, the lexical–functional distinction makes predictions about the size and category of the verb’s complement. Since functional verbs simply occupy a position in another verb’s extended projection, the size of its complement follows from clausal syntax: it contains whatever structure remains below the functional head it appears in (as discussed in chapter 3 for aspectual auxiliaries). The complement of a lexical verb, on the other hand, cannot be predicted in this way. Rather, it is a lexically encoded selectional property of individual verbs. Finally, I apply two other tests, specific for Ndebele, for the lexical–functional distinction: the position of negation (30) and ability to inflect for tense (38). Both will confirm the hypothesis that, unlike participle-selecting LVs, subjunctive-selecting LVs are lexical verbs.

### Thematic structure: both types of LVs are raising verbs

Recall that both types of light verbs are treated uniformly in the descriptive literature, and are referred to as *adverbial auxiliaries* or *deficient verbs* (Khumalo, 1981; Slattery, 1981). This uniform treatment is motivated by their semantic affinity (both types of LVs express adverbial meanings) and by the fact that they both take verbal complements. In fact, there appears to be another, syntactic similarity which could suggest a uniform account: both types of light verbs behave like raising verbs. In what follows I discuss three arguments that both lexical and functional light verbs are raising verbs: (i) the position of in-situ subjects, (ii) active–passive synonymy and (iii) idiom chunks.

(i) *In-situ subjects*. Recall from chapters 2 and 3 that postverbal subjects appear immediately to the right of their verb whose thematic subject they are. This is the in-situ position created by

short verb movement to Voice (8), from which they do not control agreement for the verb (9)

(8) The derivation of VS order in Ndebele

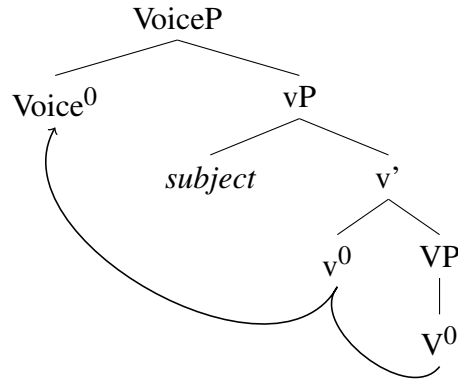

- (9) a. UZodwa u-suk-ile.  
 1Zodwa 1s-leave-FS.PST  
 'Zodwa left.'
- b. Ku-suke-e: uZodwa.  
 17s-read-FS.PST 1Zodwa  
 'It's Zodwa who left.'

The diagnostic based on in-situ subjects was used in chapter 3 to show a difference between lexical verbs and auxiliary verbs: neither default nor aspectual auxiliaries can be immediately followed by an in-situ subject, suggesting that the surface subject not their thematic subject. Lexical-LV constructions in Ndebele behave like compound tenses and aspectual-auxiliary constructions in this respect: the subject must either precede both verbs, or follow both verbs, but crucially, it cannot intervene between the light verb and the main verb. As we see in (10) and (11), this is true for participle- and subjunctive-selecting LVs alike. Here, I illustrate with subject wh-questions. Wh-phrases are especially effective in identifying the subject's in-situ position since wh-subjects are *required* to remain in-situ (otherwise they must be clefted).



(10) PART-selecting LVs

- a. Ku- lokhe ku- bala **bani**. *lokhe* ‘still’  
17s- keep 17s- read 1who  
‘Who is still reading?’
- b. \*Ku- lokhe **bani** ku/e- bala.  
17s- keep 1who 17s/1s- read  
(‘Who is still reading?’)
- c. Ku- hlezi ku- bala **bani**? *hlezi* ‘always/constantly’  
17s- constantly 17s- read 1who  
‘Who constantly reads?’
- d. \*Ku- hlezi **bani** ku/e- bala?  
17s- constantly 1who 17s/1s- read  
(‘Who constantly reads?’)
- e. Ø- se ku- bal-e: **bani**? *se* ‘already/now’  
17s- already 17s- read-FS.PST 1who  
‘Who has already read?’
- f. \*Ø- se **bani** ku/e- bal-ile?  
17s- already 1who 17s/1s- read-FS.PST  
(‘Who has already read?’)

(11) SBJV-selecting LVs

- a. Ku-ya-ke ku-bale **bani**? *ke* ‘some time’  
17s-PRES-someT 17s-read.SBJV 1who  
‘Who sometimes reads?’
- b. \*Ku-ya-ke **bani** ku/e-bale?  
17s-PRES-someT 1who 17s/1s-read.SBJV  
(‘Who sometimes reads?’)
- c. Ku-mane ku-bale **bani**? *mane* ‘just’  
17s-just 17s-read.SBJV 1who  
‘Who just reads?’
- d. \*Ku-mane **bani** ku/e-bale??  
17s-just 1who 17s/1s-read.SBJV  
‘Who just reads?’

- e. Ku-za-phinda ku-bale **bani**? *phinda* ‘again’  
 17s-FUT-again 17s-read.SBJV 1who  
 ‘Who will also read?’
- f. \*Ku-za-phinda **bani** ku/a-bale.  
 17s-PST-again 1who 17s/1s-read.SBJV  
 (‘Who will also read?’)
- g. Ku- za- qala ku-bale **bani**? *qala* ‘first’  
 17s- FUT- first 17s-read.SBJV 1who  
 ‘who will first cook?’
- h. \*Ku- za- qala **bani** ku/a- pheke?  
 17s- FUT- first 1who 17s/1s- read.SBJV  
 (‘who will first cook?’)

Given that light verbs, of either type, cannot be immediately followed by a wh-subject, we conclude that they do not have thematic subjects, and the wh-phrase in (10) and (11) is base-generated as the subject of the main, lexical verb. This similarity between participle- and subjunctive-selecting LVs should not, however, lead us to the conclusion that all the light verbs above are functional verbs. It is perfectly possible that (at least) some of them are lexical unaccusative verbs. I argue that this is indeed the case. Unlike participle-selecting LVs, subjunctive-selecting LVs are lexical unaccusative verbs. Thus, the ban on medial-position subjects has a different source in the two LV-constructions. PART-selecting LVs do not have thematic subjects because they spell out functional heads outside of the argument-structure domain (i.e. for the same reason why default auxiliaries don’t have thematic subjects). SBJV-selecting LVs do not allow a postverbal subject because they are unaccusative, i.e. raising, verbs. Their surface subject is the thematic subject of their complement verb. The structures below show the two possible subject positions in both types of LV-constructions, demonstrating two different sources of the same surface pattern, namely the unavailability of a medial subject position.<sup>1</sup>

---

1. For simplicity, I’m assuming that unaccusative verbs do not project a VoiceP but nothing hinges on this assumption.

(12) Lexical Light Verbs: no medial subject position

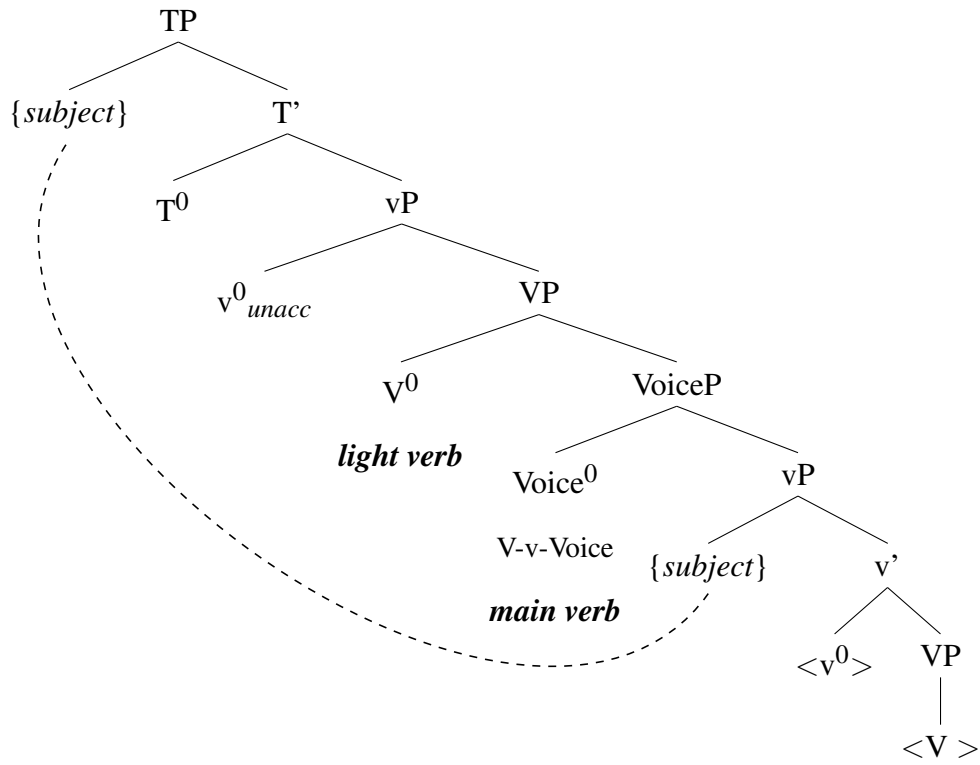

(13) Functional Light Verbs: no medial subject position

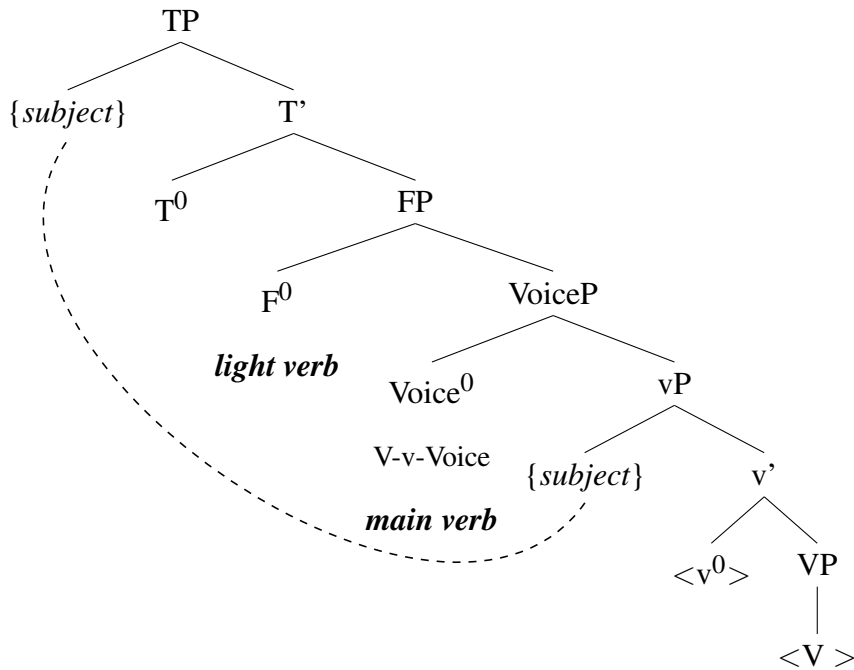

Evidence that the unavailability of medial subject position has a different source in the two LV-constructions (as shown above) will be discussed in the next section, where I present asymmetries between PART-selecting and SBJV-selecting LVs which point to the lexical–functional classification. Before that, let us consider the remaining two diagnostics for the raising status of both types of light verbs.

(ii) *Active–passive synonymy*. Under the hypothesis that light verbs in Ndebele are raising verbs, we predict that they will show the standard behavior of raising verbs with respect to active–passive synonymy. In particular, the active–passive synonymy is preserved after raising. We saw in chapter 3 that this is true of compound tenses (14) and aspectual-auxiliary constructions (15)–(17), suggesting that both are raising constructions.

- (14) a. UZodwa u-za-be e-pheka inyama.  
 1Zodwa 1s-FUT-AUX 1s-cook 5meat  
 Zodwa will be cooking meat.

- b.≈ Inyama i-za-be i-phek-w-a ng-uZodwa.  
 9meat 9s-FUT-AUX 9s-cook-PASS-FS by-1Zodwa  
 The meat will be cooked by Zodwa.
- (15) a. UZodwa u-lokhe e-pheka inyama.  
 1Zodwa 1s-still 1s-cook.IMPF 5meat  
 Zodwa first cooking meat.
- b.≈ Inyama i-lokhe i-phek-w-a ng-uZodwa.  
 9meat 9s-still 9s-cook-PASS-FS by-1Zodwa  
 The meat is still being cooked by Zodwa.
- (16) a. UZodwa u-hlezi e-pheka inyama.  
 1Zodwa 1s-constantly 1s-cook.IMPF 5meat  
 Zodwa constantly cooks meat.
- b.≈ Inyama i-hlezi i-phek-w-a ng-uZodwa.  
 9meat 9s-constantly 9s-cook-PASS-FS by-1Zodwa  
 The meat is constantly cooked by Zodwa.
- (17) a. UZodwa u-se e-pheke: inyama.  
 1Zodwa 1s-already 1s-cook.PST 9meat  
 Zodwa has already cooked the meat.
- b.≈ Inyama i-se i-phek-w-e: ng-uZodwa.  
 9meat 9s-already 9s-cook-PASS-PST by-1Zodwa  
 The meat has already been cooked by Zodwa.

Once again, SBJV-selecting LVs behave like default auxiliaries in showing raising properties. The pairs of sentences (18)-(20) illustrate meaning preservation after raising in SBJV-selecting LVs.

- (18) a. UZodwa u-phinda a-pheke inyama.  
 1Zodwa 1s-again 1s-cook.SBJV 5meat  
 Zodwa is cooking meat again.
- b.≈ Inyama i-phinda i-phek-w-e ng-uZodwa.  
 9meat 9s-again 9s-cook-PASS-SBJV by-1Zodwa  
 The meat is being cooked again by Zodwa.
- (19) a. UZodwa u-qala a-pheke inyama.  
 1Zodwa 1s-first 1s-cook.SBJV 5meat  
 Zodwa first cooks meat.

b.≈ Inyama i-qala i-phek-w-e ng-uZodwa.  
 9meat 9s-first 9s-cook-PASS-SBJV by-1Zodwa  
 The meat is cooked first by Zodwa.

(20) a. UZodwa u-za-ze a-pheke inyama.  
 1Zodwa 1s-FUT-eventually 1s-cook.SBJV 5meat  
 Zodwa will eventually cook the meat.

b.≈ Inyama i-za-ze i-phek-w-e ng-uZodwa.  
 9meat 9s-FUT-eventually 9s-cook-PASS-SBJV by-1Zodwa  
 The meat will eventually be cooked by Zodwa.

(iii) *Idiom chunks*. Finally, both types of light verbs show raising properties with respect to a diagnostic based on idiom chunks. This is demonstrated with the idiomatic expression in (21), whose subject, *iqaqqa* ‘skunk’, is part of the idiom.

(21) Iqaqa a-li-zizwa ukunuka  
 5skunk NEG-5s-smell 15stink  
 Idiomatic: ‘People don’t see their own faults’  
 Literal: ‘A skunk doesn’t smell its own stink’

As we see below, preservation the idiomatic meaning is found both with subjunctive-selecting LVs (22) and with participle-selecting LVs (23), revealing their raising status.

(22) Subjunctive-selecting LVs

a. Iqaqa li-mane li-nga-zizwa ukunuka. ✓ Idiom  
 5skunk 5s-just 5s-NEG-smell 15stink  
 ‘People just don’t see their faults’

b. Iqaqa li-yake li-nga-zizwa ukunuka. ✓ Idiom  
 5skunk 5s-sometimes 5s-NEG-smell 15stink  
 ‘People sometimes don’t see their faults’

c. Iqaqa li-za-ze li-nga-zizwa ukunuka. ✓ Idiom  
 5skunk 5s-in.the.end 5s-NEG-smell 15stink  
 ‘In the end, people won’t see their faults’

(23) Participle-selecting LVs

- a. Iqaqa li-lokhe li-nga-zizwa ukunuga. ✓ Idiom  
5skunk 5s-still 5s-NEG-smell 15stink  
'People still don't see their faults'
- b. Iqaqa Ø-se li-zizwa ukunuka. ✓ Idiom  
5skunk 5s-now 5s-smell 15stink  
'People are now starting to see their faults'
- c. Iqaqa li-hlezi li-nga-zizwa ukunuka. ✓ Idiom  
5skunk 5s-constantly 5s-NEG-smell 15stink  
'People constantly don't see their faults'

We thus conclude that neither participle- nor subjunctive-selecting LVs projects external arguments, and therefore diagnostics based on thematic structure render the same effect: both types of light verbs show raising properties. I argue, however, that this uniform behavior is not indicative of a uniform nature of the two LV types and that only PART-selecting LVs are functional verbs. The relevant asymmetries are discussed in following subsections and they point to the functional–lexical classification. The first argument is based on co-occurrence and ordering restrictions. When the two types of light verbs co-occur, the participle-selecting verb must precede the subjunctive-selecting verbs. The second piece of evidence comes from the position of negation: participle-selecting LVs, just like default auxiliaries, cannot host negation. Subjunctive-selecting LVs can be negated, just like lexical verbs. The third criterion is the possibility to host tense inflection. As discussed in chapter 4 (section 4.5.1), participle-selecting light verbs are inflectionally deficient – they cannot be inflected for tense. Subjunctive-selecting LVs can host tense marking just like any other lexical verb. I illustrate and discuss the three differences and argue that they can be naturally captured by the functional–lexical classification.

### Ordering and co-occurrence restrictions

According to Cinque's universal hierarchy hypothesis, functional projections are subject to a universally fixed ordering. This ordering has been taken as fundamental in accounting for the order

of adverbs, which are analyzed by Cinque as specifiers of functional projections associated with particular aspectual/temporal meanings: the order in which they appear is fixed and determined by the universal hierarchy of functional projections. Similar claims have been made for functional verbs. Assuming that functional verbs realize functional heads in this hierarchy, they are subject to the same ordering restrictions. The inventory of functional LVs in Ndebele is way too small to test the full range of predictions that follow from Cinque’s hierarchy. Neither is it my goal here. We have, however, seen evidence for one general hypothesis about the functional structure, namely the Perfect-over-Asp generalization (chapter 3, section 3.3.3). The evidence came from the relative ordering aspectual auxiliaries: the auxiliary *se* ‘already’, being a realization of the Perf<sup>0</sup> head, must precede the auxiliaries *lokhe* ‘still’ and *hlezi* ‘constantly’, both associated with (imperfective) viewpoint aspect.

In this subsection, we focus on two other types of ordering and co-occurrence restrictions. First, we will look at less fine-grained restrictions, namely between LVs in the functional domain (i.e. the ones realizing both Perf and Asp) and LVs which are lexical – subjunctive-selecting LVs. And second, we will investigate possible co-occurrences of SBJV-selecting LVs.

The co-occurrence restrictions between PART-selecting LVs and SBJV-selecting LVs are very rigid: when the two types of LVs cooccur, the PART-selecting LV must precede the SBJV-selecting LV. The reverse order is impossible, irrespective of the particular verbs involved (24). In the examples below, PART-selecting LVs are italicized, while SBJV selecting LVs are in bold.

(24) ✓ PART-selecting LV > SBJV-selecting LV

- a. U-*hlezi*      e-**mane**      a-bale  
       1s-constantly 1s-just.PART 1s-read.SUBJ  
       ‘He constantly just reads’
- b. U-*hlezi*      e-**phose**      a-bale  
       1s-constantly 1s-almost.PART 1s-read.SUBJ  
       ‘He constantly almost reads’



- c. U-*lokhe* e-**qala** a-bale  
1s-still 1s-first.PART 1s-read.SUBJ  
'He still reads first'
- d. U-*se* e-**phinde:** wa-pheka  
1s-already 1s-again.PART 1s-cook.PST.SUBJ  
'He has already cooked again'

(25) \*SBJV-selecting LV > PART-selecting LV

- a. \*U-**mane** a-*hlezi* e-bala  
1s-just 1s-constantly.SBJV 1s-read.PTCP  
(‘He just constantly reads’)
- b. \*U-**phose** a-*hlezi* e-bala  
1s-almost 1s-constantly.SBJV 1s-read.PTCP  
(‘He almost constantly reads’)
- c. \*U-**qala** a-*lokhe* e-bala  
1s-first 1s-still.SBJV 1s-read.PTCP  
(‘He still reads first’)
- d. \*U-**phinda** a-*se* e-bal-a/ile  
1s-again 1s-already.SBJV 1s-read-PTCP/PST.PTCP  
(‘He has already cooked again’)

The data in (24) support the analysis proposed here that PART-selecting verbs are functional verbs, spelling out functional heads in the extended projection of a lexical verb, here a SBJV-selecting LV. As shown in (26), any functional LV (whether it’s in Perf<sup>0</sup> or in Asp<sup>0</sup>) can precede a lexical LV.

(26) [TP [PerfP LV<sub>func</sub> [AspP LV<sub>func</sub> [VP LV<sub>lex</sub> [VoiceP main verb ]]]]]

The fact that functional LVs cannot *follow* lexical LVs (25) is not predicted by the lexical–functional division. Rather, it depends on the size of the lexical LV’s complement. In order to combine with functional LVs, the lexical LV must select a large enough constituent: one which contains the relevant functional structure (AspP and PerfP). The unavailability of the LV<sub>lex</sub><LV<sub>func</sub> ordering is accounted for by a different part of the proposal, namely that the complement of a lexical LV is a

VoiceP, and therefore is too small contain the functional structure that would host functional LVs. I return to this question in the next section.

Another prediction of the proposal in (26) is that SBJV-selecting verbs, being lexical verbs, should not be subject to ordering restrictions. Indeed, as we see in (27)-(30), the mutual ordering of SBJV-selecting LVs shows a considerable amount of flexibility. In some cases, ordering correlates with a change in meaning (30), in others it does not (27)-(29).

- (27) a. Ngi-za-phinda ngi-mane ngi-bale.  
1sg.s-FUT-again 1sg.s-just.SBJV 1sg.s-read.SBJV  
I will just read again.
- b. Ngi-za-mane ngi-phinde ngi-bale.  
1sg.s-FUT-again 1sg.s-just.SBJV 1sg.s-read.SBJV  
I will just read again.
- (28) a. U-ya-ke a-mane a-pheke  
1s-PRES-someT 1s-just.SBJV 1s-cook.SBJV  
He sometimes just cooks.
- b. U-mane a-ke a-pheke  
1s-just 1s-someT.SBJV 1s-cook.SBJV  
He sometimes just cooks
- (29) a. U-za-mane a-qale a-pheke.  
1s-FUT-just 1s-first.SBJV 1s-cook.SBJV  
He will just cook first
- b. ?UJohn uzaqala a-mane apheke.  
1s-FUT-first 1s-just.SBJV 1s-cook.SBJV  
He will just cook first
- (30) a. Ngi-za-phinda ngi-qale ngi-pheke  
1sg.s-FUT-again 1sg.s-first.SBJV 1sg.s-cook.SBJV  
I will again cook first
- b. Ngi-za-qala ngi-phinde ngi-pheke  
1sg.s-FUT-first 1sg.s-again.SBJV 1sg.s-cook.SBJV  
I will start by cooking again.

Co-occurrence restrictions within LVs point to the conclusion that PART-selecting LVs are func-

tional: they cannot be freely reordered among each other and they precede lexical verbs. According to the same criteria, SBJV-selecting LVs behave like lexical verbs: they can be preceded by functional verbs and they can co-occur freely with each other.

## Negation marking

Another point of variation is the marking of negation on the light verb. I have shown in chapter 3 that auxiliaries and lexical verbs can be distinguished by whether they can be morphologically negated. The basic contrast is repeated below, where the lexical verb can host a negative prefix, whether it is a simple tense expression (31-a) or a participle in a compound tense (31-b). The auxiliary verb, however, cannot be morphologically negated (31-c). Whether the negation prefix is high (preceding the subject agreement prefix) or low (following the agreement prefix), depends on whether the negated verb is in a simple tense form (31-a) or in a compound tense (31-c). Recall that in compound tenses, the auxiliary prevents negation from moving to a higher position.

- |      |    |   |   |
|------|----|---|---|
| (31) | a. | A-ka-bali.<br><b>neg</b> -1-read<br>He doesn't read                     | Negation on a lexical verb (simple tense) |
|      | b. | U-be e-nga-bali.<br>1-AUX 1- <b>neg</b> -read<br>'He wasn't reading'    | Negation on a lexical verb (participle)   |
|      | c. | *A-ka-be e-bala.<br><b>neg</b> -1-AUX 1-read<br>( 'He wasn't reading' ) | Negation on a auxiliary verb              |

In this respect, SBJV-selecting LVs pattern with lexical verbs – they can host a negation prefix (32). We've seen already that PART-selecting LVs behave like default auxiliaries in that they cannot combine with negation (33).

(32) Negation in lexical-LV constructions (cf. (31-a))<sup>2</sup>

- a. A-ka-qali a-bale.  
**neg**-1s-first 1s-read.SUBJ  
He doesn't first read.
- b. A-ka-mane a-bale.  
**neg**-1s-just 1s-read.SUBJ  
He doesn't just read.
- c. A-ngi-phindi ngi-pheke.  
**neg**-1sg.s-again 1sg.s-read.SUBJ  
I don't read again.

(33) Negation in functional-LV constructions (cf. (31-b)-(31-c))

- a. \*A-ka-lokhe e-bala. *lokhe* 'still'  
**neg**-1-still 1-read  
(‘He is still not reading’)
- b. U-lokhe e-nga-bali.  
1-still 1-**neg**-read  
(‘He is still not reading’)
- c. \*A-ka-hlezi e-bala. *hlezi* ‘constantly’  
**neg**-1-constantly 1-read  
(‘He doesn’t constantly read’)
- d. U-hlezi e-nga-bali.  
1-constantly 1-**neg**-read  
(‘He constantly doesn’t read’)
- e. \*A-ka-se e-balile. *se* ‘already/now’  
**neg**-1-already 1-read.PST  
(‘He hasn’t already/yet read’)
- f. \*U-se e-nga-balanga.  
1-always 1-**neg**-read.PST.NEG  
(‘He hasn’t already/yet read’)

The proposal made here attributes this asymmetry between the two LV types to the functional–lexical distinction. That is, functional LVs cannot combine with negation for the same reason why

---

2. As we will see later in section, some lexical LVs allow their subjunctive complement to be negated as well.

default auxiliaries can't – because they are generated above NegP and constitute a phase boundary for Neg-clitic movement to  $\Sigma$ P. Lexical LVs do not face this problem because, being lexical verbs, they have their own full extended projection, which includes NegP. Thus, they are generated below NegP and cannot themselves constitute a phase boundary for Neg-clitic movement.<sup>3</sup> The structures below show the derivation of high negation in lexical-LV constructions (34-a) and low negation in functional-LV constructions (34-b).

(34) a. Lexical LVs: negation prefixed on the LV

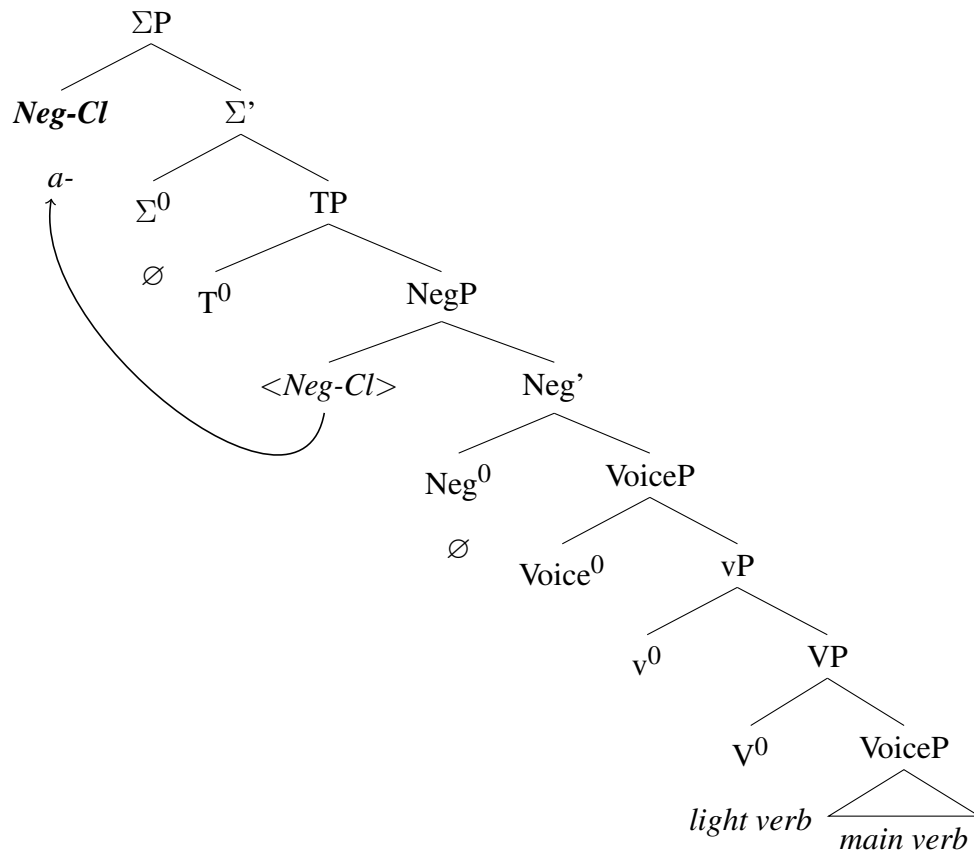

3. It is possible for the lexical LV to be itself embedded in a compound tense structure, in which case negation will be marked on it as it is on participles.

b. Functional LVs: negation prefixed on the main verb

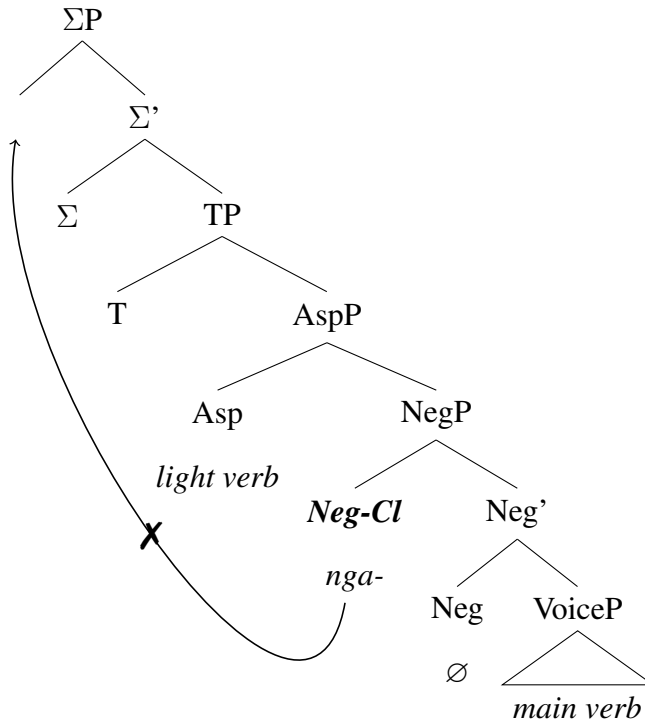

While the contrast above, i.e. low negation with functional LVs and high negation with lexical LVs, follows from clause structure and the functional–lexical classification of light verbs, the current proposal does not make clear predictions about the possibility of *low* negation in lexical-LV constructions, i.e. on the lower, lexical verb. The size of a lexical LV’s complement is determined by *selection*, not by clause structure (as is the case with complements of functional LVs). Therefore, it is entirely possible that a lexical LV may select a large enough constituent to host negation. Indeed, most lexical LVs allow their complements to be negated.<sup>4</sup> For many speakers, the position of negation correlates with a change in meaning: a different scope of negation with respect to the light verb. This is illustrated below with the verb *qala* ‘first’ (35) and *mane* ‘just’ (36).

---

4. The verb *ke* ‘sometimes/once’ is the only lexical LV which, for most speakers, cannot take a negative complement

- (35) a. Ngi-qala **ngi-nga**-pheki.  
 1sg.s-first 1sg.s-NEG-cook  
 ‘I first don’t cook (The first thing I do is not cook)’
- b. **A**-ngi-qali ngi-pheke.  
 NEG-1sg.s-first 1sg.s-cook  
 ‘I don’t cook first’ (Cooking is not the first thing I do).
- (36) a. Ngi-mane **ngi-nga**-pheki.  
 1sg.s-just 1sg.s-NEG-cook  
 ‘(When I’m alone) I just don’t cook.’
- b. **A**-ngi-mane ngi-pheke. (Ngipheka nxa ngilambile).  
 NEG-1sg.s-just 1sg.s-cook (1sg.cook when 1sg.hungry)  
 ‘I don’t just cook’ (I cook when I’m hungry)

I assume that light verbs which can combine with a negative subjunctive complement have the option to select for a VoiceP or a NegP – the lower functional projection associated with negation (38). Thus, the complement of a lexical LV may host negation but, in the absence of a clausal periphery, it does not project a  $\Sigma$ P and only the low negation marker *nga-* can be used (compare (35-a) with the ungrammatical (37-a), and (36-a) with the ungrammatical (37-b)).

- (37) a. \*Ngi-qala **a**-ngi-pheki. (cf. (35-a))  
 1sg.s-first NEG-1sg.s-cook  
 (‘I first don’t cook’)
- b. \*Ngi-mane **a**-ngi-pheki. (cf. (36-a))  
 1sg.s-just NEG-1sg.s-cook  
 (‘I just don’t cook’)

(38) Low negation on a lexical LV's complement

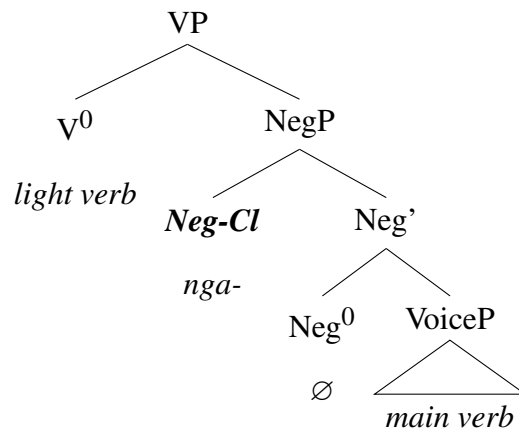

The crucial difference between PART-selecting and SBJV-selecting LVs is that only the latter type can be morphologically negated. In this respect, SBJV-selecting LVs pattern with lexical verbs, while PART-selecting LVs pattern with default auxiliaries, supporting the hypothesized functional–lexical classification.

### Ability to combine with tense

Finally, the two types of light verbs behave differently in the way they inflect for tense. SBJV-selecting LVs can be fully inflected, like any lexical verb (39). PART-selecting LVs, on the other hand, cannot combine with tense morphology (40).



(39) SBJV-selecting LVs

- a. ✓ u-**a**-mane  
1s-PST-just
- b. ✓ u-**za**-mane  
1s-FUT-just
- c. ✓ u-**a**-qala  
1s-PST-first
- d. ✓ u-**za**-qala  
1s-FUT-first
- e. ✓ u-**a**-phose  
1s-PST-almost
- f. ✓ u-**za**-phose  
1s-FUT-almost

(40) PART-selecting LVs

- a. \*u-**a**-lokhe  
1-PST-still
- b. \*u-**za**-lokhe  
1-FUT-still
- c. \*u-**a**-hlezi  
1-PST-always
- d. \*u-**za**-hlezi  
1-FUT-always
- e. \*u-**a**-se  
1-PST-already
- f. \*u-**za**-se  
1-FUT-already

The impossibility of tense markers on aspectual auxiliaries was discussed in the previous chapter (section 4.5.1), where I argued that the ungrammaticality of these forms supports the view of default periphrasis as triggered a feature conflict. Recall that lexical verbs have an unvalued Infl feature, while functional heads have valued Infl (unless they are unmarked, like present tense in Ndebele) (Adger, 2003, a.o.). According to the the proposal put forth in chapter 3, aspectual auxiliaries (i.e. participle-selecting LVs) are functional verbs – they realize functional heads such as Asp or Perf. As such, they host specific values of Infl (Infl:PST, Infl:IMPF). Thus, lexical LVs have the featural makeup in (41-a), while functional LVs have the featural makeup in (41-b) (I omit level values of category features).

(41) Featural makeup of lexical and functional verbs

- a. Lexical verbs: [Infl:\_\_\_, CAT:V]
- b. Functional verbs: [Infl:val, CAT:V]

The crucial difference between functional and lexical verbs is in whether the Infl-feature is valued

or not. And it is this minimal difference that underlies the tense marking contrast in (39)-(40).

Let us start with lexical LVs, which have an unvalued Infl-feature. When a higher inflectional head, such as T, is merged, it must check its [SEL:V] feature against a head with [CAT:V]. In LV-constructions, the closest [CAT:V] is on the light verb, as shown in (42) (let us ignore the main verb for the moment).<sup>5</sup>

(42) Lexical LV: synthesis with tense

U-**za**-qala a-bale.  
 1-FUT-first 1-read.SBJV  
 'He will first read'

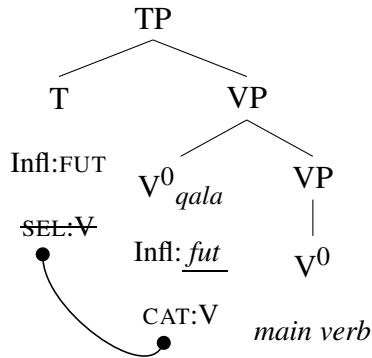

As proposed before, a functional head with a valued Infl (such as the future tense T in (42)) may check its [SEL:V] feature against a lower verb under the condition that the verb has an unvalued Infl. This condition is met in (42), where the light verb, being a lexical verb, has an unvalued Infl. Thus, V-checking may and does obtain, and is followed by Infl-valuation. In other words, tense can combine with lexical LVs in the same way as with main verbs: in the absence of intervening inflectional heads, it yields a synthetic expression.

The situation is different with functional verbs. Functional verbs have a *valued*, rather than an unvalued, Infl-feature. This property of functional verbs is responsible for the fact that they cannot combine with tense. The lack of an unvalued feature makes the functional verb inactive for

---

5. Note that the structures from now on are often simplified to only represent the immediately relevant projection. They are only a convenient notational simplification.

V-checking and thus it prevents T from checking its [SEL:V] feature against it (43). The unchecked selectional V-feature on T triggers merge of a verbal expletive, giving rise to default periphrasis on top of the aspectual auxiliary (44).

(43) Functional LV and T: no synthesis

\*U-**za**-*lokhe* e-bala.  
 1-FUT-still 1-read.PART  
 ‘He will still be reading’

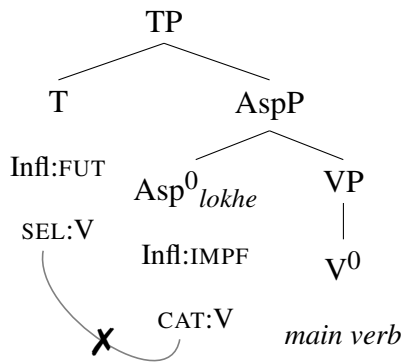

(44) Functional LV and T: periphrasis

U-**za**-be e-*lokhe* e-bala.  
 1s-FUT-AUX 1s-still 1s-read.PART  
 ‘He will still be reading’

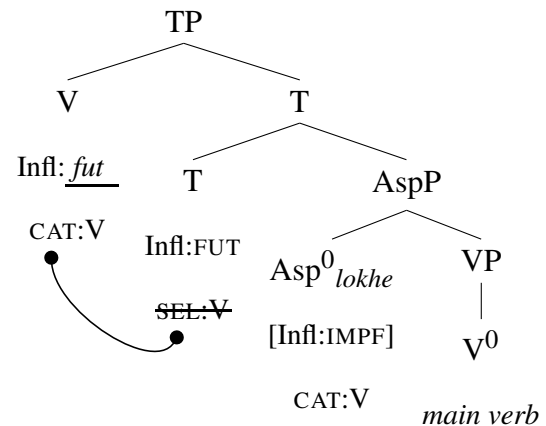

Thus, the contrast between the two types of LVs in the way they inflect for tense is naturally accounted for by the functional–lexical split.

We have seen in this section that participle- and subjunctive-selecting light verbs, despite behaving uniformly like raising verbs, show different behavior with respect to other morphosyntactic phenomena. All of the differences (ordering and co-occurrence restrictions, position of negation and the ability of host tense marking) point to the conclusion that light verbs selecting participles are functional verbs, while light verbs combining with subjunctive verb forms are lexical verbs. The minimal morphosyntactic difference between lexical and functional verbs is the type of Infl-feature: functional verbs have a valued Infl, while lexical verbs have an unvalued Infl. They additionally differ in level values of their category features: lexical LVs are verbs of level 1 (fully projecting verbs), while functional LVs, as proposed in previous chapters, are verbs of higher,

functional levels. The typology of light verbs in Ndebele is presented in (45).

(45) Typology of light verbs in Ndebele

functional LVs	lexical LVs
CAT:⟨V,n>1⟩	CAT:⟨V,1⟩
Infl:val	Infl:___

In section 5.3, I argue that the selected morphology (participial vs subjunctive forms) in LV-constructions is a direct consequence of the minimal difference in (45), and that, given the systematic asymmetries between the two LV-types, it need not be stipulated as a selectional property of individual light verbs. Before that, however, let us have a closer look at another syntactic aspect of lexical-LV constructions, namely the size of their complement. The next subsection reviews arguments for the proposal that a lexical LV's complement is a small clause-like constituent, namely a VoiceP.

### 5.2.2 *The size of lexical LVs' complement*

It was shown in chapter 3 that the complement of aspectual auxiliaries, i.e. functional LVs, is entirely predictable: it falls out from the position of the functional head which hosts the auxiliary. No such predictions can be made for lexical LVs – being lexical verbs, they are at the bottom of their own extended projection. Their complement is, therefore, determined via selection and is specified lexically. I proposed at the beginning of this chapter that lexical LVs select for a VoiceP (or optionally a NegP). We have seen one piece of evidence that the complement of lexical LVs is not larger than VoiceP/NegP, namely the fact the lexical LVs cannot take aspectual auxiliaries as complements (which would require selecting AspP and PerfP). In this section, I present additional evidence for the proposed complement size of lexical LVs. First, it will be shown that they do not combine with a larger clausal constituent, such as CP or TP. Second, we will see that they also cannot be thought of as radical restructuring clusters, where the main verb is a bare VP (as is the



that full (finite) clauses contain a projection of T which may attract and agree with a subject DP (48-a). As we've seen before, small subjunctives cannot be immediately preceded by a subject DP (i.e. one which would intervene between the light verb and the main verb), suggesting that the landing site for an agreeing subject, i.e. Spec,TP, is not available in this type of subjunctive complements (48-b).

(48) TP: only Clausal Subjunctives can have a preverbal subject (in Spec,TP)

- a. Ku-fanele [ ukuthi **uZodwa** abale. ] *Clausal Subjunctive*  
 17-must COMP 1Zodwa 1.read.sbjv  
 'Zodwa must read'.
- b. \*Ku-qala [ **uZodwa** abale. ] *Small Subjunctive*  
 17-first 1Zodwa 1.read.sbjv  
 ('Zodwa first reads')

As expected, subjunctive clauses may express perfect aspect, indicating the availability of the Perf<sup>0</sup> head in the clause (49-a). Notice that perfect aspect in a subjunctive clause requires an default auxiliary. In contrast, small subjunctives may not host perfect participles, whether a default auxiliary is used or not (49-b).

(49) PerfP: only Clausal Subjunctives can express Perfect aspect

- a. Ngi-ku-funa [ ukuthi u-be u-balile. ] *Clausal Subjunctive*  
 1sg.s-2sg.o-want COMP 2sg.s-aux 2sg.s-read.PST  
 I want you to have read/be done reading.
- b. \*U-qala [ (u-be) u-balile. ] *Small Subjunctive*  
 2sg.s-first 2sg.s-aux 2sg.s-read.PST

The same contrast arises with respect to viewpoint aspect (AspP): clausal subjunctives may host imperfective participles (50-a), while small subjunctives cannot (50-b).<sup>7</sup> Again, imperfective

---

7. One speaker judged (50-b) as marginally acceptable. Nonetheless, even for that one speaker there is a sharp contrast between this example and the perfectly grammatical use of imperfective aspect in clausal subjunctives.

aspect in a subjunctive CP requires default periphrasis, and small subjunctives are ungrammatical with the imperfective irrespective of the presence of an auxiliary.

(50) AspP: only Clausal Subjunctives can express imperfective aspect

- a. Ngi-ku-funa [ ukuthi u-be u-bala. ] *Clausal Subjunctive*  
 1sg.s-2sg.o-want COMP 2sg.s-aux 2sg.s-read.IMPF  
 I want you to be reading.
- b. \*/? U-qala [ (u-be) u-bala. ] *Small Subjunctive*  
 2sg.s-first 2sg.s-aux 2sg.s-read.IMPF

The absence of Perf<sup>0</sup> and Asp<sup>0</sup> projections in small subjunctives is additionally evidenced by possible orderings of lexical and functional light verbs. As discussed in the previous section, lexical LVs, which select small subjunctives, cannot precede functional LVs, which are associated with certain inflectional heads. The light verb *lokhe* ‘still do’, for instance, spells out an imperfective Asp<sup>0</sup>. The contrast below follows from the claim that AspP is available only in clausal subjunctives (51-a), but not in small subjunctive (51-b).

(51) AspP: only Clausal Subjunctives can contain aspectual auxiliaries

- a. Ngi-ku-funa [ ukuthi u-be u-**lokhe** u-bala. ]  
 1sg.s-2sg.o-want COMP 2sg.s-aux 2sg.s-still 2sg.s-read.IMPF  
 I want you to still be reading.
- b. \*U-qala [ (u-be) u-**lokhe** u-bala. ]  
 2sg.s-first 2sg.s-aux 2sg.s-still 2sg.s-read.IMPF

We do have evidence, however, that the complement of lexical-LVs can contain a VoiceP, as indicated by the fact that it can be passivized (52) (we’ve seen these facts earlier in this chapter in (18)-(20)).

- (52) a. UZodwa u-phinda a-pheke inyama.  
 1Zodwa 1s-again 1s-cook.SBJV 5meat  
 Zodwa is cooking meat again.

b. ≈ Inyama i-phinda i-phek-w-e                      ng-uZodwa.  
       9meat 9s-again 9s-cook-PASS-SBJV by-1Zodwa  
       The meat is being cooked again by Zodwa.

Finally, we've seen that LVs typically allow (low) negation marking on their complement. Given these facts, I propose that small subjunctives, i.e. complements of lexical LVs, have the size of a VoiceP, and optionally a NegP. In the absence of negation on the small subjunctive complement, I do not represent NegP in the trees.

In this section, I provided evidence that subjunctive-selecting LVs are indeed lexical verbs, as they show systematically similar behavior as lexical main verbs (the position of negation, synthesis with tense inflection and flexibility in co-occurrence with each other). In this respect, they contrast with participle-selecting light verbs, which show properties of auxiliaries and are therefore analyzed as functional verbs – verbal elements realizing inflectional heads such as Perf<sup>0</sup> and Asp<sup>0</sup>. I have also argued that the complement of lexical light verbs is a VoiceP/NegP, and does not contain higher inflectional categories. In the next section, I move on to the remaining question, concerning the source of subjunctive and participial morphology of light verbs's complements and develop an account in which the morphology is not *selected* in the technical sense, but rather follows directly from the functional–lexical distinction within the class of light verbs.

### 5.3 Deriving participial and subjunctive morphology in LV constructions

So far we have established that functional light verbs combine with the main verb in its participial form, while lexical light verbs require the main verb to have subjunctive morphology. The difference between the two forms is reflected in the shape of the final suffix and, in the case of class-1 agreement, in the form of the subject agreement prefix. Participles come in two types: an imperfective participle has the final suffix of the form *-a* (53-a), while in past participles, the final suffix is *-ile* (53-b) (or *-e*.; in the conjoin alternate). The final suffix is the subjunctive is *-e* (54).



- (53) a. U-lokhe e-phek-a.  
 1s-still 1s-cook-IMPF.FS  
 ‘He is still cooking’
- b. U-se e-phek-ile  
 1s-already 1s-cook-PST.FS  
 ‘He has already cooked’
- (54) U-qala a-phek-e.  
 1s-first 1s-cook-SBJV.FS  
 ‘He first cooks’

The question arises of what is the source of this morphological variation. That is, why do functional LVs combine with participles, while lexical LVs with subjunctive forms. One straightforward answer would be that it is a matter of selection. Light verbs such as *lokhe* or *se* in (53) have a selectional feature which requires their complement to be a participle. Verbs like *qala* in (54), on the other hand, have a different selectional requirement – for a subjunctive form. I argue against this view, however, pointing out a major shortcoming of a selection-based account: its inadequacy to capture the observed systematicity of selected morphology. As an alternative, I develop an analysis which derives the participle–subjunctive alternation from the functional–lexical dichotomy. In particular, I propose that the form of the main verb is a morphological reflex of the way in which its Infl-feature is valued. Participles arise in the normal cases of *direct* valuation by a functional head with a valued Infl, as discussed at length in chapter 3 (55). The configuration in lexical LV constructions is different – unlike functional LVs, lexical light verbs have a *unvalued* Infl. Thus, even though an Agree relation between the two verbs may be established, no valuation will take place until a higher inflectional head is merged (56). I call this relation *dependent valuation* – the value of Infl on the main verbs depends on the value that the light verb receives later in the derivation.

(55) Functional LV: *direct valuation*

U-lokhe e-bala.  
 1s-still 1s-read.PTCP  
 'He is still reading'

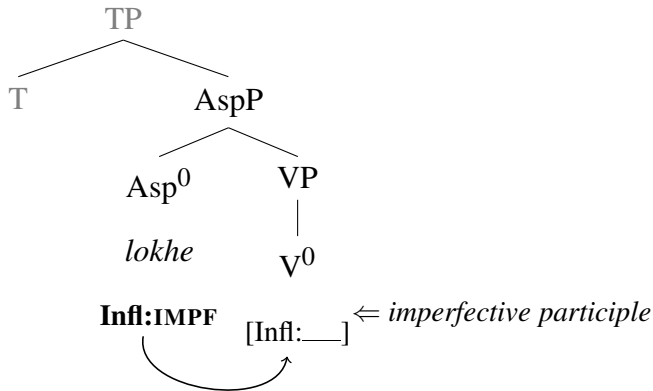

(56) Lexical LV: *dependent valuation*

U-qala a-bale.  
 1s-first 1s-read.SBJV  
 'He first reads'

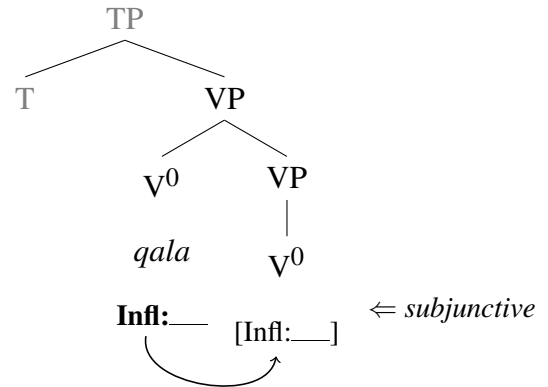

A participial form is then treated as the default non-subjunctive morphology, encoding its Infl-value as a particular form of the final suffix (in the way discussed in chapter 3). Subjunctive forms, on the other hand, are the reflex of dependent valuation. Thus, the selected morphology is a direct consequence of the minimal difference between functional and lexical verbs, namely a valued vs unvalued Infl-feature.

### 5.3.1 Against a selection-based account

In chapter 3, I considered the VP-approach to auxiliary verbs and argued that it is inadequate for both default auxiliaries and aspectual auxiliaries (i.e. functional LVs). One important argument against the VP-approach was based on clause structure – specifically, the claims that are necessary under the VP-approach about where in the clause such auxiliary-VPs are projected and how the form and size of their complement is determined. For instance, how we account for the fact that the aspectual auxiliary *lokhe* ‘still’ can only combine with an imperfective participle, while the auxiliary *se* ‘already’ allows either an imperfective participle or a past participle as its complement. In a selection-based account this asymmetry between the two light verbs would be implemented as

a difference in selectional features, as shown in (57).

$$(57) \quad se \left[ \begin{array}{l} \text{CAT: V} \\ \text{SEL: Perf/Impf} \end{array} \right] \qquad \qquad \qquad lokhe \left[ \begin{array}{l} \text{CAT: V} \\ \text{SEL: Impf} \end{array} \right]$$

The selectional flexibility of *se*, but not of *lokhe*, is treated as a lexical accident in (57). I argued that such an analysis misses an important generalization: the Perfect-over-Asp generalization, according to which perfect aspect (Perf<sup>0</sup>) is a higher inflectional category than viewpoint aspect (Asp<sup>0</sup>). Treating aspectual auxiliaries as functional verbs associated with specific inflectional heads *predicts* both the size of selected complement and the fact that *se* (in Perf<sup>0</sup>), but not *lokhe* (in Asp<sup>0</sup>), exhibits apparent selectional flexibility. As shown in (58), *se* combines with an imperfective participle when an imperfective AspP is projected, but in the absence of imperfective aspect, the perfect is the closest inflectional feature to the verb, giving rise to a past participle.

(58) *se* allows an imperfective or a perfect participle as its complement

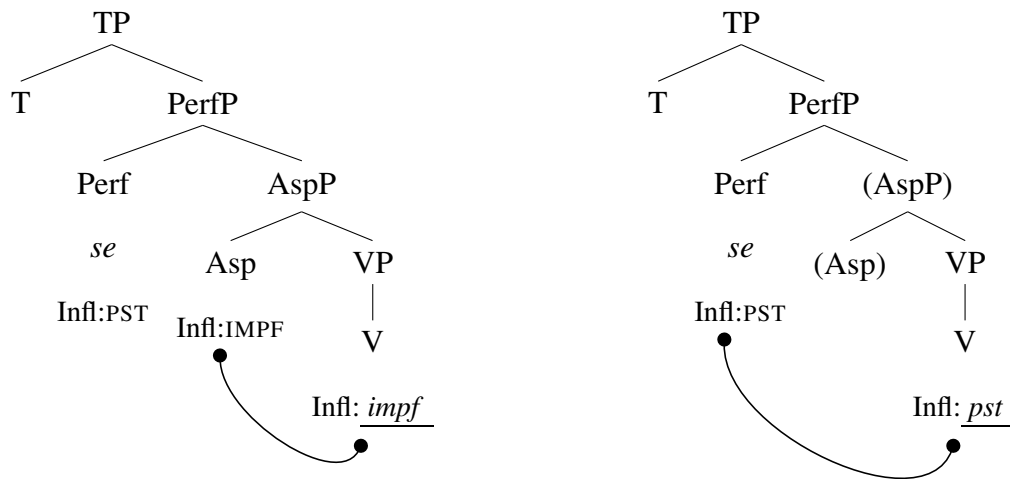

Assuming the *lokhe* ‘still’ is associated with an imperfective Asp<sup>0</sup>, locality of agreement predicts that this functional verb can combine with imperfective participles but not with a past participle.

(59) *lokhe* requires an imperfective participle

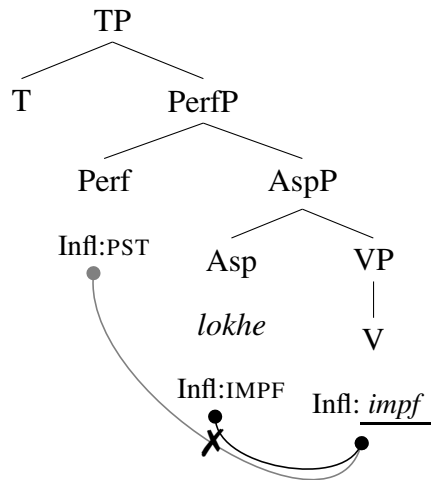

Thus, the FP-approach to aspectual auxiliaries is superior to the VP-approach as it derives main-verb morphology from independent properties of clause structure and from locality of agreement.

The subjunctive–participle alternation in light-verb constructions is another case of variation in main-verb morphology that could be captured by selection. Regardless of the past/imperfective inflection, complements of functional verbs share a common characteristic – the allomorph *e-* of class-1 subject agreement prefix, which is traditionally treated as the property of participles in general. In subjunctive verbs, the subject agreement prefix for class 1 is *a-*. Thus, the patterns of subject agreement allomorphy suggest that participial and subjunctive forms are separate classes of verbal forms, and crucially, classes which are not defined by the value of Infl (participles, for example, can have different Infl-features). If the emergence of participial vs subjunctive morphology is the result of selection, functional verbs must have a selectional feature specified for a participle (the choice between perfect and imperfective being determined syntactically, by agreement), as e.g. in (60-a). Lexical LVs, on the other hand, would have their selectional feature specified for subjunctive mood (60-b).

- (60) a.  $se \left[ \begin{array}{l} \text{CAT: V} \\ \text{SEL: PTCP} \end{array} \right]$                       b.  $qala \left[ \begin{array}{l} \text{CAT: V} \\ \text{SEL: SBJV} \end{array} \right]$

Note that, in addition to such selectional requirements, the actual complements, in order to be selected, must be specified for the relevant feature: PTCP or SBJV. That is, a constituent such as VoiceP must have at least three possible incarnations: i) one with a PTCP feature (to be selected by a functional verb in Asp), ii) one with a SBJV (to be selected by a lexical LV), and iii) one neither feature – when it appears in a simple tense, i.e. with neither participial nor subjunctive morphology.

Again, a signature property of a selection-based analysis is that it unflinchingly captures attested patterns. But here, it does so at the cost of ignoring interesting and important generalizations. Functional LVs *systematically* take participial complements, while lexical LVs *systematically* take subjunctive complements. Accounting for the form of the complement by selection makes this correlation accidental. My objective here is to better understand observed patterns in verbal morphology, and modeling them as lexical idiosyncrasies offers no such promise. With this in mind, I argue in the rest of this chapter that the selected morphology is *a consequence* of the functional–lexical split within light verbs, and not a lexical property of individual light verbs encoded in addition to their functional or lexical status.

### 5.3.2 *Subjunctive morphology as a reflex of **dependent valuation***

Given the systematic syntactic asymmetries between PART-selecting and SBJV-selecting LVs, I argue that the PART/SBJV alternation has syntactic, not idiosyncratic, grounds. In particular, the alternation is triggered by the type of Infl-feature, valued or unvalued, on the light verb. Since valued Infl-features are a property of functional verbs, while unvalued Infl-features are a property of lexical verbs, the selected morphology directly correlates with the functional–lexical split.

I propose that participial morphology arises when the main verb’s Infl is valued *directly* by a higher Infl. This is the case in compound tenses, such as the Future Imperfective in (61),

and in functional verb constructions, e.g. involving the imperfective aspectual verb *lokhe* ‘still’ (62). As shown below, both constructions involve a configuration where the closest Infl-feature c-commanding the main verb is valued (here Infl:IMPF), and therefore direct valuation can obtain. The difference between them boils down to whether Asp<sup>0</sup> is verbal (as in (62)) or not (61), but that difference is orthogonal to the question of Infl-agreement with the main verb and therefore to the emergence of an imperfective participle.

- (61) U-∅-be e-bala  
 1s-PST-AUX 1s-read.IMPF.PTCP  
 ‘He will be reading’

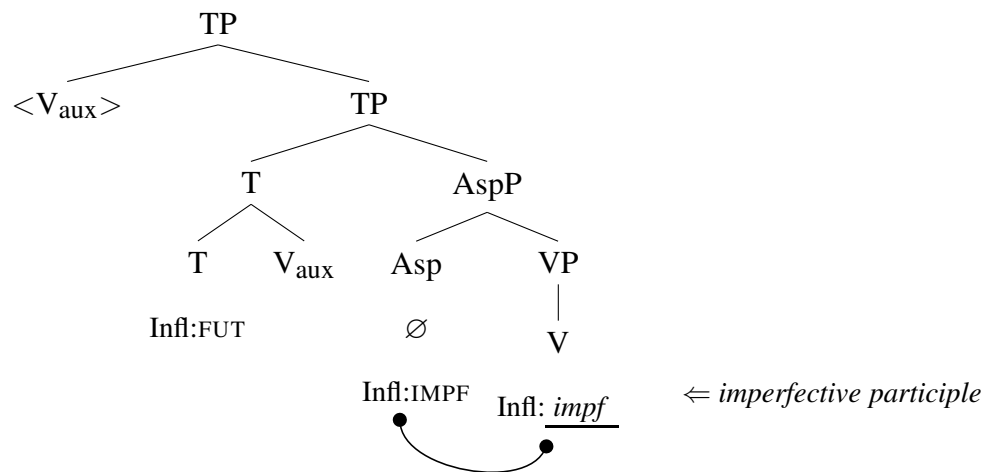

- (62) U-∅-be e-lokhe e-bala  
 1s-PST-AUX 1s-still 1s-read.IMP.F.PTCP  
 ‘Hes will still be reading’

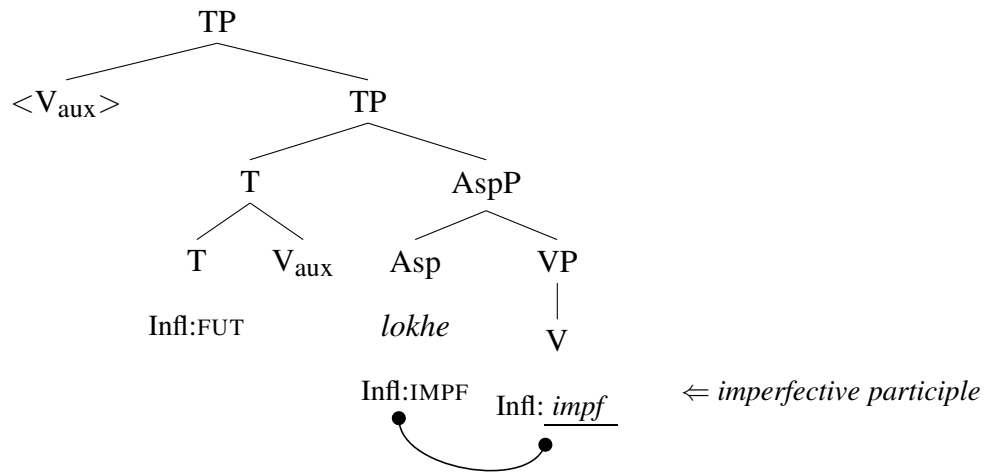

Subjunctive morphology arises when the main verb’s Infl cannot be valued at the first attempt, i.e. when the closest c-commanding Infl-feature is unvalued. This is the case in lexical-LV constructions (63).

- (63) [<sub>T</sub> Infl:val [<sub>V<sub>LexLV</sub></sub> Infl:\_\_\_ [<sub>V<sub>main</sub></sub> Infl:\_\_\_ ]]

As indicated in (63), I assume that an agree link can be established between two unvalued features (Pesetsky & Torrego, 2007). I argue, however, that valuation in such a relation is not vacuous, and that instead the higher unvalued feature assigns a dependency feature, DEP, to the lower feature which it failed to value. Thus, the derivation of Infl-agreement in lexical LV constructions proceeds as follows. The main verb’s unvalued Infl finds a matching goal on the c-commanding light verb and an Agree relation is established (64-a). Now, since the matching goal has no value, it will assign a dependency feature to the main verb (64-b). Nonetheless, the Infl-features on both

verbs remain unvalued until a valued Infl is merged later in the derivation.

(64) a. Agree relation established

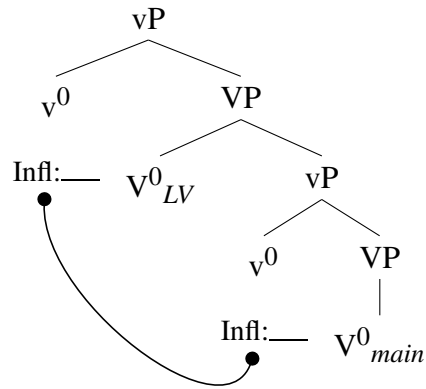

b. No valuation; DEP assignment

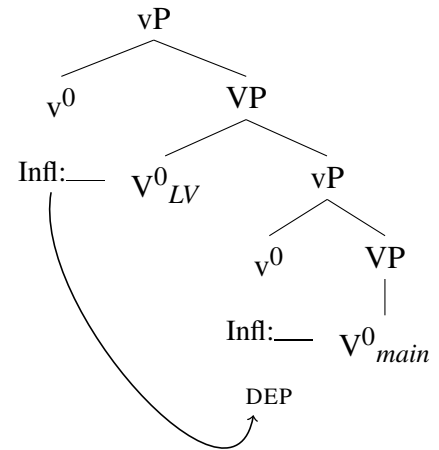

I call this process *dependent valuation* and define it below.

(65) **Dependent valuation**

- a. Structural description:  $\alpha_{[F: \_ ]}$  c-commands  $\beta_{[F: \_ ]}$
- b. Structural change:  $\beta_{[F: val(F_\alpha), DEP]}$

In addition to DEP assignment to the lower head, dependent valuation results in linking the two unvalued features, so that after the higher one is valued, the value will automatically be assigned to the lower feature as well. This is encoded in (65) by replacing the value of F on  $\beta$  with a value variable,  $val(F_\alpha)$ , which tracks the value of F on  $\alpha$ .

As an example, consider the lexical-LV construction in (66), with future tense.



- (66) Ngi-za-qal-a      ngi-phek-e.  
 1sg.s-FUT-first-FS   1sg.s-cook-FS.SBJV  
 ‘I will first cook’

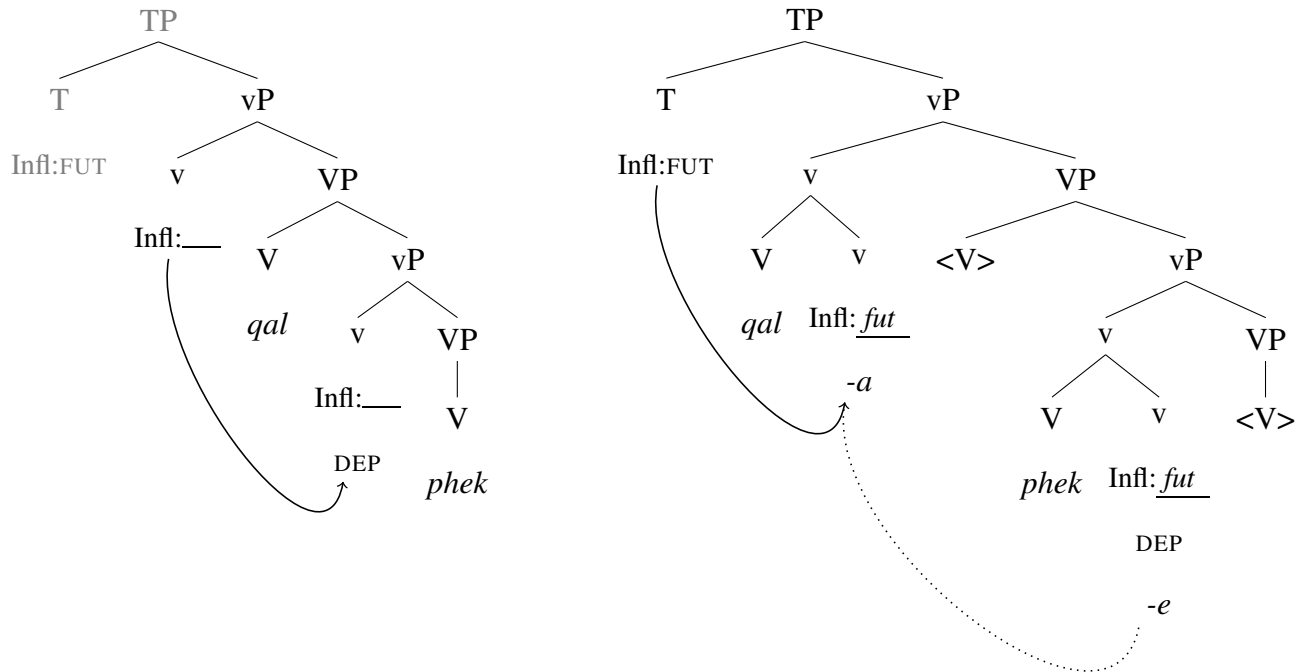

Before T is merged, the main verb establishes a relation with the lexical light verb, which in turn assigns a DEP feature to the main verb by (65) and turns the main verb’s Infl-value into a value variable tracking the LV’s Infl. When T is merged, the light verb undergoes regular Infl-agreement with it (direct valuation). The light verb’s Infl is valued as FUT, which in turn affects the value variable on the main verb. In effect, both verbs are valued as FUT, but only the main verb additionally has a DEP feature.

Under this view, subjunctive morphology is a verbal form which arises from vocabulary insertion in the context of DEP. In the future tense example above, the light verb is inflected for future tense (expressed by the prefix *za-* and the final vowel *-a*). The subjunctive form of the main verb is encoded as the final suffix *e*. As shown in (67), the subjunctive final suffix is an exponent of a little *v* with a DEP feature, while the final suffix on the light verb is a realization of the same set of

features without DEP.

- (67) a. /e/ ↔ v,DEP  
b. /a/ ↔ v

Recall that the final suffix is not the only morphological marker of subjunctive mood. Additionally, we observe allomorphy in subject agreement for class 1. I return to the questions of allomorphy in Chapter 6.

### 5.3.3 *Independent evidence for dependent valuation: tense agreement*

The analysis of small subjunctives developed in the previous section treats subjunctive morphology as a reflex of dependent valuation, which in turn accounts for the systematic selection of subjunctive forms by lexical light verbs, but not by functional light verbs. In this section, I present independent evidence that the two LV-constructions indeed involve different types of valuation: direct valuation by functional verbs and dependent valuation by lexical verbs. The evidence comes from tense agreement in lexical-LV constructions, and the lack of such tense co-variation in functional-LV constructions.

Complements of lexical LVs show inflectional variability: the form is always subjunctive, but it *additionally* covaries with tense. In particular, if tense is present or future, as in (68-a) and (68-b), the main verb surfaces as *present subjunctive* – the form I have been referring to simply as *subjunctive*. If, however, T has the value Infl:PST, the light verb’s complement appears in the *past subjunctive* form (68-c)<sup>8</sup>

---

8. It is likely that what I gloss as an agreement prefix in the past subjunctive form in (68-c), i.e. *wa-*, should be decomposed into two morphemes: the subject agreement prefix *u-* followed by the prefix *a-*. The second component resembles the past tense marker *a-*, causing past subjunctive forms segmentally identical to Distant Past forms. They do differ tonally, however: compare the Distance Past indicative form *wábala*, where the first syllable bears a high tone, with the past subjunctive form: *wabála*, with a high tone the second vowel. I do not have an account of this difference and I must leave the details of subjunctive morphology for the future.

- (68) a. U-∅-qal-a      a-bale                      **Present T: present subjunctive**  
 1-PRES-first-FS 1-read.**sbjv**  
 ‘He first reads’
- b. U-za-qal-a      a-bale                      **Future T: present subjunctive**  
 1-FUT-first-FS 1-read.**sbjv**  
 ‘He will first read’
- c. U-∅-qal-e:      wa-bala                      **Past T: past subjunctive**  
 1-PST-first-FS.PST 1-read.**pst.pres.sbjvj**  
 ‘He first read’

No such co-variation with tense is observed in complements of functional light verb. Consider, e.g. *lokhe*, which takes an imperfective participle as its complement (69-a). We’ve seen before that *lokhe* cannot combine with past participles. Crucially, this is also true if past tense does appear in the clause. As we see in (69-b), past tense (which must be realized on an auxiliary in functional LV constructions), cannot trigger the appearance of a past participle form of the main verb.

- (69) a. U-∅-be      e-lokhe e-bala                      **imperfective participle ✓**  
 1-PST-AUX 1-still 1-read.**impf.ptcp**  
 ‘He was still reading’
- b. \*U-∅-be      e-lokhe e-balile                      **\*past participle**  
 1-PST-AUX 1-still 1-read.**pst.ptcp**

The relevant observation is the following: complements of functional LVs have fixed morphology, while complements of lexical LVs show some morphological flexibility. Importantly, the participle–subjunctive split remains intact. That is, the inflectional flexibility in complements of lexical LVs never results in the complement being a participle, rather than a subjunctive. The inflectional variability is *specific to* subjunctives. This in turn suggests that the emergence of the participle/subjunctive morphology is independent of the inflectional variability observed in small subjunctives. This rationale is represented in the table below, where the categories *participle* and *subjunctive* are types of *forms* and are on a different tier than what I call *inflection*.

(70)

	complements of functional LVs	complements of lexical LVs
FORM	participle	subjunctive
INFLECTION	fixed	flexible

One aspect of (70) is the differentiation between *form* and *inflection*. I leave this discussion for chapter 6, where I argue that inflection, defined as a specific value of the Infl-feature, is entirely independent of *forms* (which include participial, subjunctive and indicative forms). For now, let us concentrate on another aspect of (70), namely the fact that inflectional flexibility is a property of subjunctive complements only, and is not observed in participial complements.

As discussed above, lexical LVs differ from functional LVs in that they have an unvalued Infl feature, like any lexical verb. Since, by dependent valuation, the unvalued Infl-feature of the main verb is bound by the Infl-feature of the light verb, they always end up sharing the same Infl-value, as shown again for past tense in (71).

- (71) a.  $[_T \text{Infl}_3:\text{PST} \quad [_{V_{LV}} \text{Infl}_2: \text{—} \quad [_{V_{main}} \text{Infl}_1: \text{—} ] ]]$
- DEP
- ┌───────────┐  
│          │  
└──────────┘
- b.  $[_T \text{Infl}_3:\text{PST} \quad [_{V_{LV}} \text{Infl}_2: \text{—} \quad [_{V_{main}} \text{Infl}_1:\text{val}(\text{Infl}_2), \text{DEP} ] ]]$
- ┌───────────┐  
│          │  
└──────────┘
- c.  $[_T \text{Infl}_3:\text{PST} \quad [_{V_{LV}} \text{Infl}_2:\underline{pst} \quad [_{V_{main}} \text{Infl}_1:\underline{pst}, \text{DEP} ] ]]$

As we have seen in (68), Ndebele has only two subjunctive forms: past subjunctive and present subjunctive. Since present subjunctive has a broader distribution, I treat it as the elsewhere subjunctive form, i.e. one which arises in the context of DEP (72-b). Past subjunctive is more specific – the relevant morphology is inserted in the context of both DEP and Infl:PST (72-a).

- (72) Subjunctive morphology in Ndebele
- a. [PST, DEP] ↔ *past subjunctive*
  - b. [DEP] ↔ (*unmarked*) *subjunctive*

The reason why subjunctives can co-vary with a higher, non-local inflectional category is *the transparency of the syntactic context they appear in*. Specifically, the fact that the intervening Infl-feature (Infl<sub>2</sub> in (71)), is unvalued. Thus, subjunctive morphology and the inflectional flexibility of subjunctive forms have the same source: an unvalued Infl-feature on the light verb.

In this light, it becomes clear why complements of functional light verbs show no inflectional flexibility. The Infl-feature on functional LVs is valued, and therefore not transparent. Instead, it follows that complements of functional verbs have a fixed inflection – the Infl assigned via direct agreement with the functional verb. For example, the aspectual auxiliary *lokhe*, which is associated with an imperfective Asp, has a valued feature Infl:IMPF. If the main verb is in the immediate context of *lokhe* (73), it must be imperfective (no transparency) and it must be a participle (no DEP assignment).

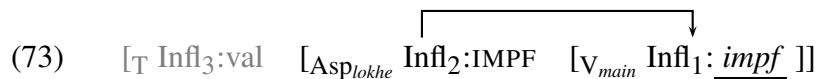

The existence of tense agreement in lexical-LV constructions supports the analysis proposed here, where both the main verb and the light verb have an unvalued Infl-feature, and where the two features are formally linked with the effect of co-variation. It additionally explains why only subjunctive complements, but not participial complement of light verbs, show this type of inflectional flexibility. The reason why a participial complement cannot co-vary with tense across the light verb is that the light verb itself has a valued Infl-feature and is therefore a closer agreement goal.<sup>9</sup> Subjunctive-selecting light verbs are inflectionally deficient – they do not have a valued Infl-

---

9. Recall from chapter 3 that the only selectional flexibility we see with aspectual auxiliaries is the ability of *se* ‘already’ to take a past or imperfective participle as its complement. This flexibility is crucially of a different sort: it does not stem from the auxiliary’s inflectional deficiency or transparency, but it follows from its position in the

feature and therefore they cannot provide a value to the main verb. In effect, main verb valuation is dependent on the Infl-value received by the light verb from a higher head.<sup>10</sup>

I have argued in the section that the choice between participial and subjunctive complements in LV constructions is not an unpredictable phenomenon and therefore should not be viewed as a lexical property of light verbs. I argued instead that the morphology "selected" by LVs follows from an independently observed classification of light verbs, the functional–lexical distinction, and from its consequence for the type of valuation involved. This view was further supported by the fact that tense agreement is only observed in the type of LV constructions which involve dependent valuation, that is in which subjunctive morphology is licensed. The next section, in contrast, discusses instances of true c-selection in lexical-LV constructions: the choice between subjunctive and infinitival complements of lexical LVs.

#### 5.4 Subjunctive vs infinitives: the role of c-selection

I argued so far that the form of the complement of light verbs can be captured by independent syntactic properties of these constructions. One question, addressed in chapter 3, had to do with the choice between imperfective and past participles, i.e. complements of functional verbs. We've seen that the attested patterns of complementation follow from the position of the aspectual verb in the functional structure. Complements of lexical light verbs, on the other hand, cannot be predicted by clausal syntax since they are not associated with functional projections. Being lexical verbs, they have the tools to *idiosyncratically* determine the size and category of their complements, namely via c-selection. Nonetheless, I argued in this chapter that the fact they combine with subjunctive

---

extended projection – it is associated with Perf and, as such, may combine with the lower aspect-related inflection. The selectional flexibility of lexical LVs is due to their inflectional deficiency, i.e. do to the fact that they have no Infl-value of their own.

10. There is an interesting connection between dependent valuation and a phenomenon found in Germanic languages, where participial forms can be licensed long-distance in verb clusters, apparently across an intervening participle. As observed by Wiklund (2005, 2007) and discussed further in Wurmbrand (2011), such *parasitic participles* in Swedish are only possible in restructuring contexts. When there is little functional structure separating the two verbs, they may have identical morphology.

forms should also not be encoded lexically, given that the choice between participial and subjunctive forms falls out from the functional–lexical classification. The question now arising is whether we observe *any* selectional idiosyncrasies in lexical-LV constructions. If we do, this would provide additional evidence for their lexical status. In this section, I present evidence that this is indeed the case. In particular, I show that some lexical LVs may optionally take DP complements. The DP complements are clause/verb nominalizations and are traditionally referred to as *infinitives* in the Bantu literature (Carstens, 1991; Nurse, 2008). The light verb *phinda* ‘again’ is an example (75).

- (74) a. Ngi-za-phinda ngi-pheke.  
 1sg.s-FUT-again 1sg.s-cook  
 ‘I will cook again’
- b. Ngi-za-phinda uku-pheka.  
 1sg.s-FUT-again INF-cook  
 ‘I will cook again’

Unlike the participle–subjunctive alternation, the selection of a small subjunctive vs an infinitive is *unpredictable*. It has no semantic or morphosyntactic correlates; that is, whether a light verb has the option of taking an infinitival complement cannot be predicted either from its meaning or syntax. Therefore, I argue, the choice between subjunctive vs infinitival complements is an instance of true c-selection: some light verbs can select either a DP (an infinitive) or a VoiceP (a small subjunctive), while others may only select for one of these categories. I further discuss another selectional possibility: some light LVs may optionally take clausal complements. Interestingly, CP complements are only allowed for those LVs which also have the option to select infinitives. I argue that this generalization follows from the fact that both infinitives and clausal complements are DPs in Ndebele, and are therefore targeted by the same selectional feature. Finally, and importantly, no functional light verb has the option of selecting an infinitive or a CP, further supporting the view that complements of functional light verbs are not determined lexically.

I start by demonstrating the patterns of selectional optionality in lexical light verbs, and the absence of such optionality with functional light verbs in the next subsection. In subsection 5.4.2,

I provide evidence for the nominal nature of both infinitives and clauses in Ndebele, which in turn explains the correlation between infinitive- and clause-selection by light verbs.

#### 5.4.1 *Patterns of selectional variability*

Among the lexical light verbs discussed in this chapter, two show selectional optionality: in addition to selecting a small subjunctive complement (examples a. in (75) and (76)), they combine with an infinitival form of the main verb, or with a clause subjunctive. Note that the verb *qala* has a different, thought related, meaning, depending on the category of its complement. With the verb *phinda*, however, we observe no change in meaning (75).

(75) *phinda* ‘do again’

- |    |  |                            |
|----|--|----------------------------|
| a. | Ngi-phinda ngi-bale.<br>1sg.s-again 1sg.s-read.SBJV<br>‘I’m reading again’             | <i>small subjunctive</i>   |
| b. | Ngi-phinda uku-bala.<br>1sg.s-again INF-read<br>‘I’m reading again’                    | <i>infinitive</i>          |
| c. | Ngi-phinda ukuthi ngi-bale.<br>1sg.s-again COMP 1sg.s-read.SBJV<br>‘I’m reading again’ | <i>clausal subjunctive</i> |

(76) *qala* ‘do first/start doing’

- |    |   |                            |
|----|---|----------------------------|
| a. | Ngi-qala ngi-bale.<br>1sg.s-start 1sg.s-read.SBJV<br>‘I read first’                     | <i>small subjunctive</i>   |
| b. | Ngi-qala uku-bala.<br>1sg.s-start INF-read<br>‘I’m starting to read’                    | <i>infinitive</i>          |
| c. | Ngi-qala ukuthi ngi-bale.<br>1sg.s-start COMP 1sg.s-read.SBJV<br>‘I’m starting to read’ | <i>clausal subjunctive</i> |



Other light verbs allow neither infinitival nor clausal complements. I illustrate with *ze* ‘finally do’ (77) and *mane* ‘just/simply do’ (78).<sup>11</sup>

(77) *ze* ‘finally do’

- |    |   |                            |
|----|---|----------------------------|
| a. | Ngi-za-ze            ngi-bale.<br>1sg.s-FUT-finally 1sg.s-read.SBJV<br>‘I will finally read’                | <i>small subjunctive</i>   |
| b. | *Ngi-za-ze            uku-bala.<br>1sg.s-FUT-finally INF-read<br>(‘I will finally read’)                    | <i>intinitive</i>          |
| c. | *Ngi-za-ze            ukuthi ngi-bale.<br>1sg.s-FUT-finally COMP 1sg.s-read.SBJV<br>(‘I will finally read’) | <i>clausal subjunctive</i> |

(78) *mane* ‘just/simply do’

- |    |  |                            |
|----|--|----------------------------|
| a. | Ngi-mane ngi-bale.<br>1sg.s-just 1sg.s-read.SBJV<br>‘I just read’                | <i>small subjunctive</i>   |
| b. | *Ngi-mane uku-bala.<br>1sg.s-just INF-read<br>(‘I just read’)                    | <i>intinitive</i>          |
| c. | *Ngi-mane ukuthi ngi-bale.<br>1sg.s-just COMP 1sg.s-read.SBJV<br>(‘I just read’) | <i>clausal subjunctive</i> |

There appears to be no morphosyntactic or semantic predictor of whether a light verb will show such variability or not. As far as their semantic properties, all verbs express meanings modifying the event introduced by the main verb, and I have not found reliable semantic traits corresponding to selectional flexibility. As discussed in the previous subsections, lexical light verbs also show

---

11. Paradigms like (75), in which the verb is selectionally unconstrained, have been given as arguments that it’s not c-selection but s-selection that governs this case of complementation (Pesetsky, 1991). In (75), the selecting verb is insensitive to the category of its complement (it can be an infinitive, a clause or a small subjunctive), and all three can be argued to have similar propositional semantics, which could be targeted by s-selection. However, the fact that not all light verbs allow this type of selectional variation points to the opposite conclusions, namely that propositional semantics is not enough to be selected by a light verb – there are category-based restrictions.

uniform behavior with respect to a number of syntactic phenomena, e.g. they can all combine with tense inflection, allow negative clitic movement to the left periphery, be complements of functional light verbs and disallow medial subjects. In this respect, they form a coherent class, distinct from functional light verbs. I argue, therefore, that the paradigms above instantiate c-selectional idiosyncrasy of individual light verbs.

No such selectional flexibility is found with functional light verbs, which may only combine with participial forms, as exemplified with *hlezi* ‘always’ in (79).

(79) *hlezi* ‘always/constantly do’

- |    |   |                                |
|----|---|--------------------------------|
| a. | Ngi-hlezi    ngi-bala.<br>1sg.s-always 1sg.s-read.IMPF.PTCP<br>‘I always read’                    | <i>imperfective participle</i> |
| b. | *Ngi-hlezi    uku-bala.<br>1sg.s-always INF-read<br>(‘I always read’)                             | <i>intinitive</i>              |
| c. | *Ngi-hlezi    ukuthi ngi-bal-a/-e.<br>1sg.s-always COMP 1sg.s-read-IND/-SBJV<br>(‘I always read’) | <i>clausal complement</i>      |

While with functional light verbs selectional flexibility is not expected, its availability for certain lexical verbs is unsurprising, and it fact supports their treatment as lexical verbs.

An interesting property of the observed patterns of selectional variability it is the correlation between infinitive- and clause-selection. The light verbs which have the option of selecting an infinitive, also have the option of selecting a clausal clausal. And conversely, light verbs which don’t combine with infinitives, also don’t take clausal complements. I argue that this correlation is a consequence of the categorial status of infinitives and embedded clauses in Ndebele as DPs. In the next section, I provide evidence for this claim.

### 5.4.2 Explaining the infinitive–CP correlation: a DP-shell hypothesis

I argue that selectional variability in lexical light verb reduces to the choice between a verbal and a nominal complement. Verbs which show such optionality may take either a VoiceP or a DP complement. I show in this section that both infinitives and clauses are DPs, and therefore verbs which have the option of selecting a DP, may take both infinitival and clausal complement, while those which only select for a VoiceP cannot combine with either an infinitive or a clause. In the discussion below, I use the verb *phinda* ‘do again’ as an instance of a selectionally flexible light verb (80-a), and the verb *mane* as an example of a verb which can only select for a VoiceP (a small subjunctive) (80-b).

- (80) a. *phinda*  $\left[ \begin{array}{l} \text{SEM: } \textit{again} \\ \text{CAT: } \langle \text{V}, 1 \rangle \\ \text{SEL: } \text{D/Voice} \end{array} \right]$                       b. *mane*  $\left[ \begin{array}{l} \text{SEM: } \textit{just/simple} \\ \text{CAT: } \langle \text{V}, 1 \rangle \\ \text{SEL: } \text{Voice} \end{array} \right]$

While the nominal natures of the so called infinitives is well evidenced in many Bantu languages (Carstens, 1991; Bresnan & Mchombo, 1995; Nurse, 2008), full clauses are not typically thought of as nominalizations (though see Bresnan (1995)). In recent work (Pietraszko, under review), I argued that Ndebele embedded clauses are also externally nominal – they project a DP shell. Thus, both infinitives and clausal complements are clausal structures with an outer DP layer. In clausal complements, the DP-shell embeds a full CPs (81), while infinitives are DPs with a more reduced clausal structure (82).<sup>12</sup>

(81) Clausal complement

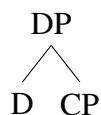

(82) Infinitival complement

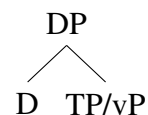

12. The precise size of an infinitival complement remains to be determined, and it is not crucial here. Preliminary evidence suggests that infinitives might undergo restructuring in the absence of marked inflectional categories, such as imperfective or perfect aspect. I leave this question for future research.

It has been shown that full clauses in some Bantu languages do behave like nominal phrases. Bresnan (1995) lists interesting asymmetries between clauses in English and Chichewa, which suggest that clauses in the two languages are not of the same category. In particular, they have the distribution typical of DPs. The distribution of clauses in Ndebele is very similar. The following three properties of nominal phrases will be relevant in our discussion of infinitives and clauses as DPs (for more detailed argumentation that embedded clauses in Ndebele, including noun-complement clauses and relative clauses, project a DP-shell, see Pietraszko (under review)):

(83) Properties of nominal complements

- i) they have an augment vowel (an exponent of D)
- ii) they can be dislocated
- iii) they can undergo argument ellipsis

*i) The augment.* The morphological structure of Ndebele DPs involves a class prefix on the nominal stem, which is in turn preceded by the so called augment vowel (also known as the pre-prefix). The augment vowel is traditionally treated as a type of determiner, (Ziervogel, 1967; von Staden, 1973; Giusti, 1997; Katamba, 2003; de Dreu, 2008; Visser, 2008; Taraldsen, 2010; Buell & de Dreu, 2013) and I follow previous work on related languages in assuming that the augment is an exponent of  $D^0$ .<sup>13</sup> As shown for the examples in (84), the augment co-varies with the class of the nominal class marker.

- |      |  |  |
|------|--|--|
| (84) | a. <b>u</b> -mu-ntu<br>1aug-1-person<br>'a person' | c. <b>i</b> -si-lwane<br>7aug-7-lion<br>'a lion' |
|      | b. <b>a</b> -ba-fazi<br>2aug-2-woman<br>'women'    | d. <b>u</b> -ku-dla<br>15aug-15-food<br>'food'   |

---

13. See Halpert (2012) for a treatment of the augment as an exponent of  $K^0$ , a case-related head projected above the DP. This detail is irrelevant in the present discussion – the important aspect of both views is that the augment is a nominal morpheme

An augment can be detected in both infinitives and clausal complements. Infinitives have the shape of nouns of class 15, the class of nominalizations (85-a).<sup>14</sup> In clausal complements, the augment can be observed on the complementizer, which morphologically and etymologically is a nominalization of the verb ‘say’(85-b).

- (85) a. **u**-ku-pheka  
 15aug-15-cook  
 ‘to cook/cooking’
- b. **u**-ku-thi  
 15aug-15-say  
 ‘to say/saying/COMP’

While the nominal etymology of the complementizer does not entail its nominal nature in present Ndebele, there is independent evidence that the augment vowel was not grammaticalized as part of the complementizer and that instead it constitutes an independent morpheme. Evidence for that analysis comes from augment drop. The augment vowel can be omitted on nominals (both common nouns and proper names in Ndebele) under certain syntactic and semantic conditions. Most prominently, objects of negated verbs may optionally appear without an augments (for analyses of augment drop in closely related languages see e.g. Progovac (1993); Halpert (2012); Carstens & Mletshe (2015)). As shown in (86-a), the augment vowel is obligatory in affirmative sentences, but in the negative counterpart in (86-b), its absence is allowed.

- (86) a. Ngi-funa [DP \*(i)-sinkwa. ] *\*augment drop*  
 1sg.s-want 7aug-7bread  
 ‘I want bread.’
- b. A-ngi-funi [DP (i)-sinkwa. ] *✓ augment drop*  
 NEG-1sg.s-want 7aug-7bread  
 ‘I don’t want (any) bread.’

---

14. The class-15 nominalizations have a broad use, parallel to the distribution of English infinitives and different types of gerunds. There is no evidence at this point that thesis different uses correspond to different external syntax of these nominalizations (as it has been argued for Swahili by Carstens (1991)).

The presence of an augment in the negative sentence seems optional, but it corresponds to a semantic difference. In particular, the augment forces an interpretation of the noun as a definite or a specific indefinite (i.e. out of the scope of negation). In the absence of an augment, the object in (86-b) must be interpreted as a narrow scope indefinite. This semantic contrast is compatible with the hypothesis that the augment is a type of determiner. That is to say, there are two types of  $D^0$  in Ndebele: the augment vowel and a null morpheme. Their distribution roughly corresponds to what we expect from the definite/indefinite dichotomy.

The augment vowel of infinitives and of complementizers can be omitted, as well. More importantly, augmentless infinitives and complementizers appear exactly in those configurations that license augmentless nominals. In the affirmative clause (87-a), the infinitives requires an augment, but in the presence of negation (87-b) the augment is optional, just like on nominal objects. Similarly, the matrix clause in (88-a) is affirmative, and the complementizer in the embedded clause must have an augment (cf. (86-a)). When the matrix verb is negated, however, its clausal object may be augmentless – the complementizer may surface as *kuthi*, i.e. without the augment vowel (88-b).

- (87) a. Ngi-funa [DP \*(u)-ku-pheka ] \*augment drop  
 1sg.s-want 15aug-15-cook  
 ‘I want to cook.’
- b. A-ngi-funi [DP (u)-ku-pheka ] ✓ augment drop  
 NEG-1sg.s-want 15aug-15-cook  
 ‘I don’t want to cook.’
- (88) a. Ngi-funa [DP \*(u)-kuthi ngi-pheke ] \*augment drop  
 1sg.s-want aug-15COMP 1sg.s-cook  
 ‘I want to cook.’
- b. A-ngi-funi [DP (u)-kuthi ngi-pheke ] ✓ augment drop  
 NEG-1sg.s-want aug-15COMP 1sg.s-cook  
 ‘I don’t want to cook.’

Infinitival and clausal complements show similar behavior when they are selected by light verbs.

The presence of negation on the light verbs allows the complement to appear without an augment, as shown in (89) and (90).<sup>15</sup>

- (89) a. Ngi-phinda [DP \*(u)-ku-pheka ] \*augment drop  
 1sg.S-again 15aug-15-cook  
 ‘I cook again.’
- b. A-ngi-phindi [DP (u)-ku-pheka ] ✓ augment drop  
 NEG-1sg.S-again 15aug-15-cook  
 ‘I don’t cook again.’
- (90) a. Ngi-phinda [DP \*(u)-kuthi ngi-pheke ] \*augment drop  
 1sg.S-again aug-15COMP 1sg.S-cook  
 ‘I cook again.’
- b. A-ngi-phindi [DP ?(u)-kuthi ngi-pheke ] ✓ augment drop  
 NEG-1sg.S-again aug-15COMP 1sg.S-cook  
 ‘I don’t cook again.’

The facts above show that infinitival and clausal objects behave like DP objects: they have an active augment vowel, which can be dropped under the same structural conditions that license augment drop on nominal objects.

ii) *Dislocation*. Nominal phrases can be dislocated. Right-dislocation is diagnosed, for instance, by an intervening temporal adverbs, such as *kusasa* ‘tomorrow’ (91). As shown in (92), both infinitives and clauses can undergo dislocation. They contrast, in this respect, with verbal complements of light verbs: the small subjunctive complement (VoiceP) of *phinda* cannot be dislocated (93).

- (91) Ngi-za-si-dla **kusasa** i-si-nkwa  
 1sg.S-FUT-7o-eat tomorrow aug-7-bread  
 ‘I will eat the bread tomorrow’

---

15. The augmentless version of (90-b) was judged as slightly degraded, compared to the parallel example in (88-b) with *funa* ‘want’ as the matrix verb. At the present moment, I have no explanation for why this contrast arises.

- (92) a. Ngi-za-(ku)-phinda **kusasa** u-ku-pheka  
 1sg.s-FUT-15o-again tomorrow aug-15-cook  
 ‘I will cook again tomorrow’
- b. Ngi-za-(ku)-phinda **kusasa** u-ku-thi ngi-pheke  
 1sg.s-FUT-15o-again tomorrow aug-15-comp 1sg.s-cook.SBJV  
 ‘I will cook again tomorrow’
- (93) Ngi-za-phinda {\***kusasa**} ngi-pheke {<sup>✓</sup>**kusasa** }  
 1sg.s-FUT-again tomorrow 1sg.s-cook.SBJV tomorrow  
 ‘I will cook again tomorrow’

Even though nominal dislocation typically requires object marking, infinitives and clauses can be dislocated without object marking – the marker *ku* is optional in both sentences in (92). This means that dislocation is not necessarily tied to the presence of an object marker. Thus, the fact that small subjunctive complements cannot control object marking (they are not nominal), is not the reason why they cannot dislocate. Rather, the ungrammaticality of (93) is due to a category difference between small subjunctives on the one hand, infinitives and clauses on the other.

*iii) Ellipsis.* Ndebele does not show clear cases of vP ellipsis (unlike other Bantu languages (Ngonyani, 1996b; Goldberg, 2005; Ngonyani & Githinji, 2006)). This can be seen in compound tenses, which do not allow ellipsis of the participial main verb under an auxiliary verb.

- (94) Q: U-za-be u-hlabela yini?  
 2sg.s-FUT-AUX 2sg.s-sing Q  
 ‘Will you be singing?’
- A: Yeah, ngi-za-be \*(ngi-hlabela).  
 yes, 1sg.s-FUT-AUX 1sg.s-sing  
 Yes, I will (be singing).

DP complements, on the other hand, can undergo object drop, which typically requires the verb to be object-marked for the class of the elided object (similarly to the closely related Zulu (Buell, 2005; Adams, 2010; Zeller, 2012)). The requirement for object agreement with a dropped object is gradient and correlates with animacy of the object – DPs with high animacy must always be



object-marked under ellipsis (95); abstract nouns (typically of class 15) may be elided without object marking (96).<sup>16</sup>

- |   |  |
|---|--|
| <p>(95) Q: U-thanda aba-ntwana yini?<br/>2sg.s-like 2-child Q<br/>'Do you like children?'</p> <p>A: Yeah, ngi-ya-*(ba)-thanda.<br/>yes, 1sg.s-pres-*(2o)-like<br/>Yes, I like them.</p> | <p>(96) Q: U-thanda uku-hlabela yini?<br/>2sg.s-like 15-sing Q<br/>'Do you like singing?'</p> <p>A: Yeah, ngi-ya-(ku)-thanda.<br/>yes, 1sg.s-pres-(15o)-like<br/>Yes, I like it.</p> |
|---|--|

Like nominal objects, infinitival and clausal complements of light verbs can be elided, as shown in (97) and (98) respectively.

- (97) Q: U-za-phinda uku-pheka yini?  
2sg.s-FUT-again 15-cook Q  
'Will you cook again?'
- A: Yeeh, ngi-za-(ku)-phinda.  
yes, 1sg.s-FUT-(15o)-again  
'Yes, I will do it again'
- (98) Q: U-za-phinda ukuthi u-pheke yini?  
2sg.s-FUT-again 15COMP 2sg.s-cook.SBJV Q  
'Will you cook again?'
- A: Yeeh, ngi-za-(ku)-phinda.  
yes, 1sg.s-FUT-(15o)-again  
'Yes, I will do it again'

Small subjunctives, on the other hand, cannot undergo ellipsis, as illustrated with the complement of *mane* 'just' in (99). In this respect, LV-constructions with a small subjunctive complement resemble compound tenses, where the main verb cannot be elided leaving only the auxiliary verb overt.

---

16. This generalization is not only true for ellipsis but also for dislocation. Dislocated abstract DP do not require object marking, while dislocated animate DPs do.

- (99) Q: U-za-mane u-pheke yini?  
 2sg.s-FUT-just 2sg.s-cook.SBJV Q  
 ‘Will you just cook?’
- A: Yeeh, ngi-za-mane \*(ngi-pheke).  
 yes, 1sg.s-FUT-just 1sg.s-cook.SBJV  
 ‘Yes, I will just cook’

Assuming that infinitives and clauses are DPs, but small subjunctives are VoicePs, the contrast between them with respect to ellipsis follows from independently observed asymmetries between verbal and nominal phrases in the language.

It should be noted at this point that the contrast between small subjunctives and clausal/infinitival complements with respect to ellipsis does not arise if we use a verb that allows all both subjunctive and clausal/infinitival complements. We saw that *phinda* is such a verb. As we see in (100), the small subjunctive antecedent is able to license ellipsis in the answer.

- (100) Q: U-za-phinda u-pheke yini?  
 2sg.s-FUT-again 2sg.s-cook.SBJV Q  
 ‘Will you cook again?’
- A: Yeeh, ngi-za-phina (ngi-pheke).  
 yes, 1sg.s-FUT-again 1sg.s-cook.SBJV  
 ‘Yes, I will just cook’

Since ellipsis licensed by small subjunctive antecedents is only possible if the light verb has the option to select clauses or infinitives, the licensing conditions are most likely influenced by that selectional flexibility. In particular, complement ellipsis in LV-constructions appears to allow category mismatches: a VoiceP antecedent can license DP-ellipsis. Mismatches of this type have been observed in previous literature (Fu et al., 2001; Johnson, 2001; Merchant, 2001, 2013), and it is an interesting question for future research to further explore the flexibility of category identity conditions on ellipsis in Ndebele.

In sum, clausal and infinitival complements show properties of nominal complements, which supports the claim that their external syntax is nominal (a DP-shell). This, in turn, explains the

observed correlation in selection of infinitival and clausal complements – light verbs which have the option to select a DP complement, may combine with either an infinitive or a full clause, while those light verbs which can only select for a VoiceP cannot combine with either (they only allow their complement to be a small subjunctive).

An important conclusion from the discussion of selectional variability is the fact that it exists, and that we observe it only with subjunctive-selecting LVs, that is lexical light verbs. As expected, participle-selecting (i.e. functional) light verbs show no such idiosyncrasy. The size and form of their complement is invariably determined by clausal syntax.

## 5.5 Conclusion

In this chapter, I compared two types of light verbs: participle-selecting LVs and subjunctive selecting LVs, and argued that the form of the LV's complement (subjunctive vs participle) correlates with a number of systematic morphosyntactic asymmetries between the two classes of light verbs, and should therefore be treated as a systematic, rather than an idiosyncratic, property of such verbs. More specifically, the observed asymmetries point to the conclusion that subjunctive-selecting LVs are lexical verbs, while participle-selecting LVs are functional verbs: verbal elements associated with specific inflectional heads, as discussed in chapter 3. Thus, lexical light verbs are an instance of a verbal element which does not introduce its own argument and event structure (in which sense it is an "auxiliary" verb), but one which, *syntactically*, has the status of a main verb: it is a lexical V projecting a full extended projection of its own. Below is a summary of the properties distinguishing lexical and functional LVs (101).

(101) Lexical and functional LVs: a summary of differences

	lexical LVs	functional LVs
can be inflected for tense?	YES	NO
can be morphologically negated?	YES	NO
how is their complement determined?	by selection	follows from clause structure
subject to ordering restrictions?	NO	YES
transparent for tense agreement?	YES	NO
form of complement	subjunctive	participle
Their featural make up:	[Infl:___, CAT:<V,1> ]	[Infl:val , CAT:<V,n>1> ]

I further argued that the role of selection in lexical LV constructions is limited to the choice between the following categories: VoiceP, NegP and DP. The choice between subjunctive and participial morphology is not an instance of c-selection. It is predictable from independent properties of light verbs, namely their status as functional and lexical verbs. The participle/subjunctive alternation is a morphological reflex of the type of valuation involved in valuing the main verb's Infl-feature. In particular, subjunctive forms are the result of dependent valuation which takes place in inflectionally deficient contexts (i.e. where the higher Infl-feature has no value to transmit). As such, the assignment of subjunctive mood morphology is seen here as a purely configurational phenomenon. It arises of inflectionally deficient syntactic contexts. The difference between form (e.g. subjunctive) and inflection (e.g. past tense) is addressed in more detail in the next chapter, where I argue for a distinction between inflectional categories and metacategories in the verbal domain. In the next chapter, I also extend the dependent valuation analysis of subjunctive morphology to clausal subjunctives.

In chapter 3, I discussed aspectual and default auxiliaries and argued that they each instantiate a distinct way in which a non-projecting verb enters the derivation (merging as functional heads or via last-resort selection, respectively). I also rejected the VP-approach for both types of auxiliaries,

arguing that none of them shows properties of verbs which project VPs. The existence of lexical light verbs provides important new evidence against the VP-approach to aspectual and default auxiliaries: the language does make use of non-thematic auxiliary-like verbs which project a VP, but crucially, they do not form a uniform class with either default auxiliaries nor aspectual auxiliaries. They are truly lexical in that they can be fully inflected (have an unvalued Infl-feature) and can idiosyncratically determine the category of their complement (verbal or nominal). The distinctive properties of lexical LVs (e.g. selectional variability, inflectional flexibility (i.e. tense agreement) or subjunctive mood morphology) were argued to be exactly the consequence of their lexical nature.

## CHAPTER 6

### EXTENSIONS OF THE THEORY

#### 6.1 Introduction

In this chapter, I discuss two outstanding issues which stem from the proposed inflectional dependencies in the Ndebele verbal domain. The first issue, the topic of section 6.2, concerns the difference between verbal morphology that corresponds to Infl-features (e.g. Infl:PST) and morphology such as the subjunctive and participial form. Throughout the thesis I used terms such as *past tense*, *imperfective aspect*, *participle* or *subjunctive mood*. Traditionally, we understand them as referring to verbal inflection or verbal morphology/form. The theory of inflectional dependencies proposed in previous chapters sheds light on the nature of such verbal forms. In particular, we've seen that what we call *a verb in a past tense form*, for example, refers to a syntactic object of category V with the feature Infl:PST. In contrast, *a verb in a participial form* does *not* refer to a syntactic object of category V with a feature Infl:PTCP (for "participle"). This is because, according to the current proposal, there is no such feature in Ndebele as Infl:PTCP. Thus, the source of participial morphology must be different than the source of past tense morphology. In this section, I take a closer look at contrasts like the one between past tense morphology and participial morphology. I propose that they are two different types of verbal morphology – what I call *inflectional categories* (e.g. past tense) and *inflectional metacategories* (e.g. participial form) (1).

- (1) Proposal: Classification of verbal morphology:
  - a. morphology expressing inflectional categories
  - b. morphology expressing inflectional metacategories

In section 6.3, I address a different question: the distribution of subject agreement prefixes in multi-verb constructions. I return to the pre-theoretical generalization that the number of subject agreement prefixes correlates directly with the number of verbs in an expression. Using the notion

of V-Chain, defined in terms of the V-selection mechanism proposed in chapter 4, I make a theoretically framed generalization about the distribution of subject agreement probes in the syntax: there is a  $\varphi$  probe on the highest head of every V-Chain. I demonstrate how this generalization correctly derives the number of agreement prefixes in a given construction, their exact position and the apparently inconsistent appearance of  $\varphi$ -probes on functional heads in the Ndebele clause.

## 6.2 Inflectional categories and metacategories

We have seen in previous chapters that certain types of verbal morphology correspond to morphosyntactic features, namely Infl-features. For instance, future tense morphology is directly related to the presence of Infl:FUT. We have also seen a different type of morphology, one which does not correspond to an Infl-feature directly. In particular, I proposed in chapter 5 that subjunctive mood morphology in lexical LV constructions is a consequence of the inflectional deficiency of its immediate syntactic context (specifically, the fact that lexical LVs have no Infl-value). In other words, while future tense morphology has a direct morphosyntactic correlate (the Infl-feature), subjunctive mood is licensed positionally – it arises morphologically in certain syntactic configurations. In this section, I propose a classification of verbal morphology based on these two parameters: *morphological categories*, or *inflections* correspond to specific values of the Infl-feature (2), while *morphological metacategories*, or *forms*, are positional variants of inflectional (and other) morphology (3).

(2) **Morphological category** (or *inflection*):

an expression determined by a morphosyntactic Infl-feature, such as Infl:PST, Infl:IMPF etc.

e.g. a past tense inflection  $\Leftrightarrow$  Infl:PST

(3) **Morphological metacategory** (or *form*):

an expression determined contextually

e.g. subjunctive mood form  $\Leftrightarrow$  morphology licensed in the context of an unvalued Infl

In addition to subjunctive forms, morphological metagategories include the participial verb form and what is called the *principal* form. In the descriptive literature, all three are called *moods* or *submoods* (Sibanda, 2004; Buell, 2005): subjunctive mood, participial mood and principal (or indicative) mood.<sup>1</sup> Subjunctive forms appear in subjunctive clauses (4-a) and as complements of lexical light verbs (4-b). Principal and participial forms are distinguished by their position in the clause: verbs in principal mood appear as the highest verb in a non-subjunctive clause, like the auxiliary verb in (5), while participles are complements of auxiliary verbs, like the main lexical verb in (5).

- (4) a. Ngi-funa ukuthi uZodwa a-phek-e  
 1sg.s-want COMP 1Zodwa 1s-cook-FS.**SBJV**  
 ‘I want Zodwa to cook’
- b. UZodwa u-za-phinda a-phek-e.  
 1Zodwa 1s-FUT-again 1s-cook-FS.**SBJV**  
 ‘Zodwa will cook again’
- (5) U-Zodwa u-za-be e-pheka  
 1Zodwa 1s-FUT-AUX.**PRIN** 1s-cook.**PTCP**  
 ‘Zodwa will be cooking’

As we see in the examples above, the three moods are typically distinguished by the form of class 1 subject marker: *u-* in the principal mood, *e-* in participles and *a-* in subjunctive forms. Putting aside the precise rules of allomorphy (for more discussion see section 6.3), we will use the form of class 1 agreement prefix as an indicator of a particular mood (i.e. metacategory).

The proposed contexts in which the three forms arise in Ndebele are the following. Subjunctive forms are licensed in inflectionally deficient contexts; in particular, when the most local Infl-feature to the verb in question is an unvalued Infl-feature (6). Indicative mood morphology is licensed in the environment of left peripheral categories. Specifically, I propose that in Ndebele the relevant context is a topic feature/head (29-b) (I will present evidence for a topic head in indicative clauses

---

1. In addition to these three, the conditional form is also sometimes referred as mood: the *conditional* or *potential* mood. More research is needed to correctly place this type of morphology in the present discussion.



in the next subsection). Finally, participial morphology is the elsewhere verbal form – one which arises in the absence of the two specific environments (29-c).

(6) **The subjunctive context:**

$V_{\text{Infl:}\_\_\_}$  is c-commanded by head H with  $\text{Infl:}\_\_\_$  and there is no  $H'$  such that  $H'$  has an Infl-feature and  $H'$  c-commands V but not H.

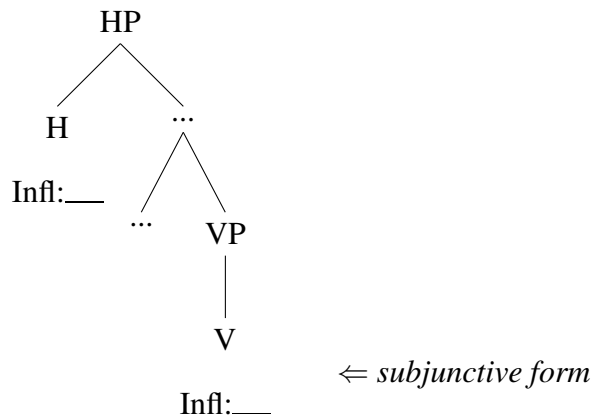

(7) **The principal context:**

V is c-commanded by Top and there is no  $V'$  such that  $V'$  c-commands V but not Top.

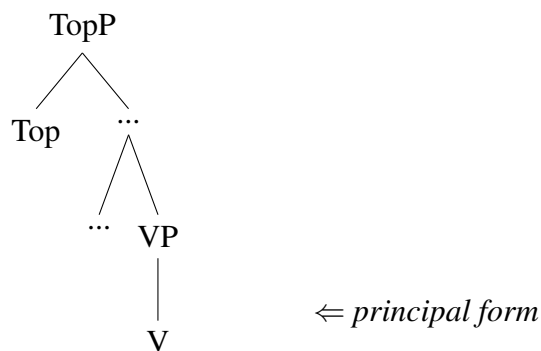

(8) **The participial context:** elsewhere

Thus, the hypothesis I put forth is that certain types of morphology (in Ndebele, the subjunctive, participial and principal forms) are licensed not by morphosyntactic features but in certain structural positions – I call this the *Positional Licensing Hypothesis* (9).

(9) **The Positional Licensing Hypothesis**

Certain types of verbal morphology (e.g. mood morphology) are licensed positionally.

The positional licensing approach to mood forms in Ndebele captures the three properties of metacategories listed in (10).

(10) Properties of metacategories in Ndebele

- a. They can cooccur with Infl-features
- b. They do not trigger inflectional periphrasis
- c. They have a systematic, not idiosyncratic, distribution

First, we have seen that two inflectional features in Ndebele cannot cooccur on a single verb – the verb has only one unvalued Infl-feature, and so inflections (e.g. past and future tense) compete for being hosted by the verb. Given the differentiation between categories and metacategories, the two are not subject to this type of cooccurrence restriction. In subsection 6.2.2, I show that every metacategory can indeed have any type Infl-value. The second property of metacategories, closely related to the first one, is their irrelevance in triggering inflectional periphrasis. This is because inflectional overflow is caused by cooccurrence of Infl-features. Metacategories do not correspond to Infl-features. Instead, we expect this morphology to be orthogonal to calculating the inflectional complexity triggering periphrasis. As we will see in section 6.2.3, this is true in Ndebele and in Latin. The third property, i.e. the lack of idiosyncratic distribution, was in part discussed in chapter 5, where I argued that participle- and subjunctive-selecting light verbs differ in systematic ways. I reiterate these arguments in the context of the Positional Licensing Hypothesis in section 6.2.4.

The crucial property of this approach to verb forms such as subjunctive or participial is that

their licensing is a purely configurational phenomenon. There are no such features as Infl:SBJV (or Mood:SBJV). In this respect, the proposed view differs fundamentally from existing approaches in which such morphology is treated as corresponding to morphosyntactic features. Although it is difficult to find literature explicitly arguing for a specific nature of morphosyntactic features corresponding to the subjunctive or participial form, they are very often assumed to be of one type or another. The subjunctive–indicative opposition is often implemented as different values of the feature attribute Mood (Mood:SBJV/IND), though treatment of mood as an Infl-feature (Infl:SBJV/IND) can also be found (e.g. in Bjorkman (2011)). The participial form has also been analyzed as corresponding to a morphosyntactic feature (e.g. T:PART in Wurmbrand (2011)). Throughout this section I point out the ways in which these alternatives are problematic when confronted with Ndebele facts.

The literature on the syntax and semantics of mood is extensive and I should note in advance that this section does not aim at a complete theory of the subjunctive–indicative contrast crosslinguistically. Rather, analyzing Ndebele morphology, I put forth a hypothesis that some verbal morphology is better understood as licensed positionally. The precise licensing conditions I propose for Ndebele should be seen as tentative in a broader crosslinguistic context.

### 6.2.1 *Positional licensing of Ndebele mood forms*

In this section, I discuss in detail the licensing environments for three metacategories in Ndebele: the subjunctive, principal and participial form. Starting with the subjunctive, I repeat briefly the analysis of subjunctive forms proposed in chapter 5, namely as morphological reflex of dependent valuation, and extend it to clausal subjunctives. I then discuss the environments in which principal and participial forms appear: generally speaking, the principal form is the form of the highest verb in a non-subjunctive clause, while participial form is default verbal morphology.

In chapter 5, I discussed the so called *small subjunctives* – complements of lexical light verbs (such as *phinda* ‘again’), whose size is a VoiceP (11-a). I argued that subjunctive mood mor-

phology in LV-constructions is due to the immediate context of the unvalued Infl-feature on the lexical LV. Additionally, Ndebele has *clausal subjunctives*, CPs introduced by a complementizer and selected by certain verbs, e.g. *funa* ‘want’, as in (11-b).

- (11) a. UZodwa u-za-phinda [VoiceP a-pheke. ]  
 1Zodwa 1s-FUT-again 1s-cook.SBJV  
 ‘Zodwa will cook again’
- b. Ngifuna [CP ukuthi uZodwa a-pheke. ]  
 1sg.s-want COMP 1Zodwa 1s-cook.SBJV  
 ‘I want Zodwa to cook’

I proposed that the subjunctive morphology on small subjunctives is due to the light verb’s nature as a lexical verb and the consequence it has for Infl-agreement. In particular, the light verb, being a lexical verb, has an unvalued Infl-feature and therefore cannot value the Infl-feature in the main verb (‘cook’ in (11-a)). As shown in (13), the dependency between the main verb and the light verb results in dependent valuation (12), whereby the LV assigns a dependency feature DEP to the main verb (13-a), linking their Infl-features for further valuation (13-b).

(12) ***Dependent valuation***

- a. Structural description:  $\alpha_{[F: \_\_]}$  c-commands  $\beta_{[F: \_\_]}$
- b. Structural change:  $\beta_{[F: \text{val}(F_\alpha), \text{DEP}]}$

(13) Subjunctive form as a reflex of dependent valuation (cf. (11-a)):

a. DEP assignment (structure before head movement)

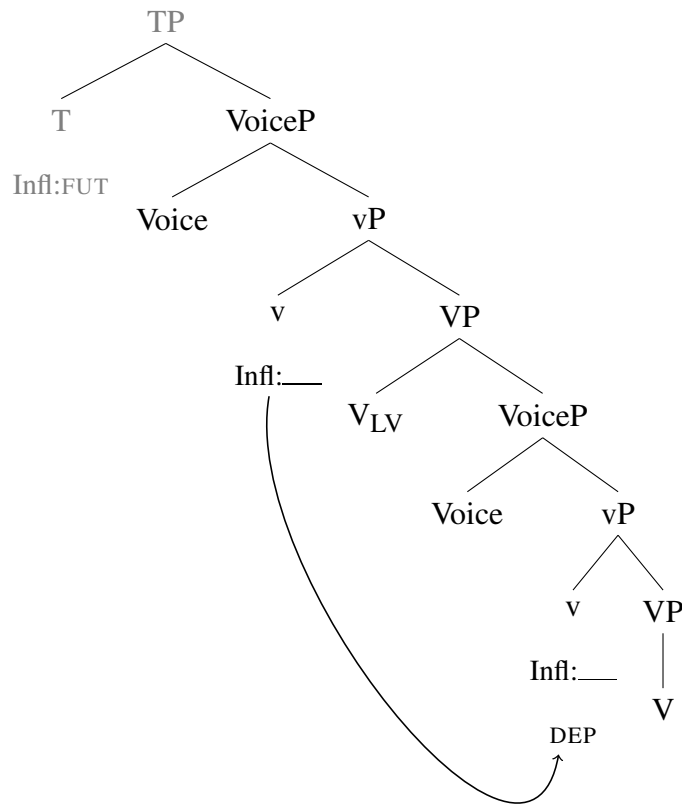

b. Further valuation by T (structure after head movement)

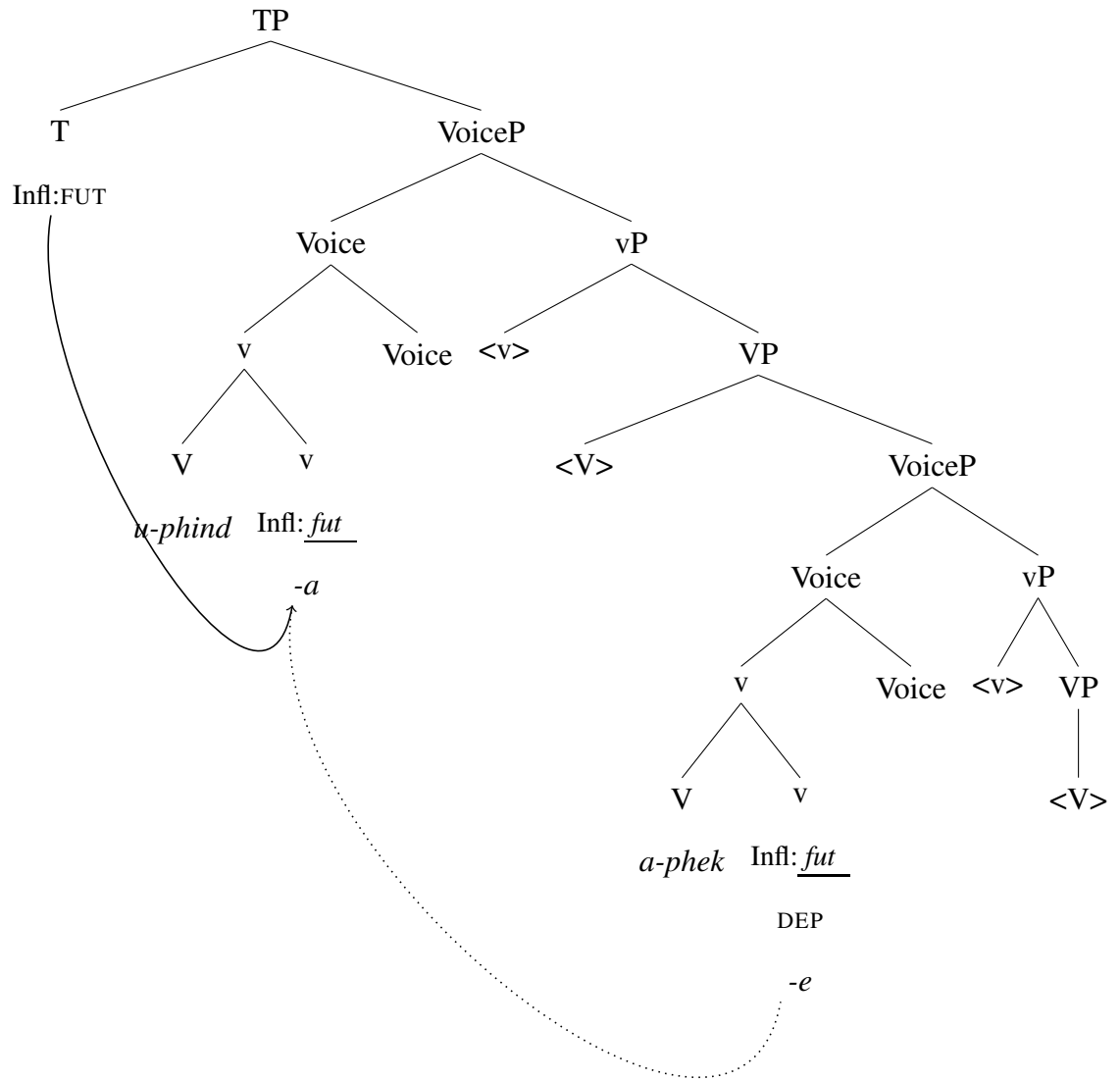

As a result of dependent valuation, both the light verb and the lexical verb are valued as Infl:FUT by T. Dependent valuation is reflected in the form of the Final Suffix (the exponent of little v): it has the form *-e* in the context of DEP (the subjunctive form) and the form *-a* in the absence of DEP, namely on the light verb, which here has a principal form. The subjunctive form is additionally identified by the form of the agreement prefix: *a-* in the subjunctive and *u-* in the principal mood.

In the structure in (13-b), I do not provide an analysis of the agreement prefix and represent it in the tree gloss as a prefix on each verb. I return to the question of the distribution of agreement prefixes in section 6.3. A detailed analysis of agreement morphology is not necessary to argue for metacategories in Ndebele and I represent agreement prefixes in this section as in (13-b).

In sum, the subjunctive mood morphology does not arise as exponence of a mood head and/or feature, but it is allomorphy of other heads/features in a dependent valuation context.

Let us now turn to clausal subjunctives – subjunctive verb forms which appear as subjunctive clauses introduced by the complementizer *ukuthi*, as shown in (11-b) above, repeated below.

- (14) Ngifuna [CP ukuthi uZodwa a-phek-e. ]  
 1sgs-want COMP 1Zodwa 1s-cook-FS.SBJV  
 ‘I want Zodwa to cook’

Notice that the form of the verb ‘cook’ in clausal subjunctives and in small subjunctives is the same: the final suffix has the form *-e* and the agreement prefix for class one *a-*. I propose that the subjunctive form in subjunctive clauses is also licensed positionally, in the same context as the same morphology in small subjunctives, namely when the closest Infl-feature to the verb in question is an unvalued Infl-feature, which triggers dependent valuation.

A widely recognized property of subjunctive clauses is their deficiency with respect to tense morphology and semantics. Subjunctive clauses typically lack an independent temporal specification and their interpretation is sensitive to the temporal specification of the matrix clause (Picallo, 1984; Comrie, 1986; Enç, 1987; Ogihara, 1989; Abusch, 1997; Giorgi & Pianesi, 1997; Landau, 2004; Giannakidou, 2009; Giorgi, 2009, a.o.). I propose that the morphosyntactic correlate of this semantic deficiency is an *unvalued*, rather than a valued, Infl-feature on the subjunctive T. This means that every subjunctive clause contains at least two heads with an unvalued Infl-feature: T and v, as shown in (15).

(15) The syntax of a subjunctive clause

Infl-agreement relation: T and v

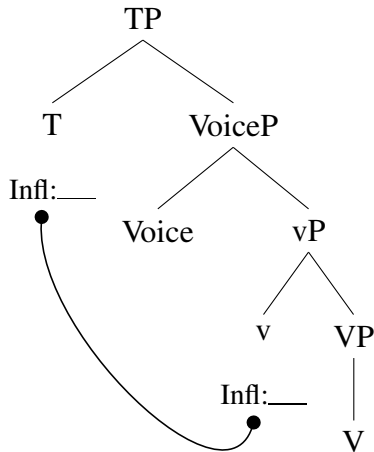

Dependent valuation by T

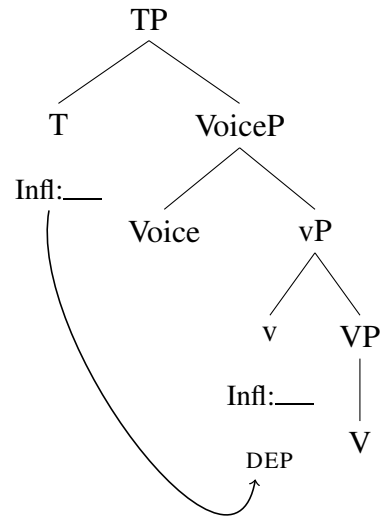

The source of subjunctive morphology in both clausal and small subjunctive is the same – the DEP feature assigned to the main verb via dependent valuation. In the case of small subjunctives, dependent valuation is done by a lexical light verb, in clausal subjunctives by the inflectionally deficient subjunctive T. Thus, we can generalize that subjunctive morphology is licensed in inflectionally deficient contexts; specifically, in the immediate context of an unvalued Infl-feature (16).



(16) **The subjunctive context:**

$V_{\text{Infl:}\_\_}$  is c-commanded by head H with  $\text{Infl:}\_\_$  and there is no H' such that H' has an Infl-feature and H' c-commands V but not H.

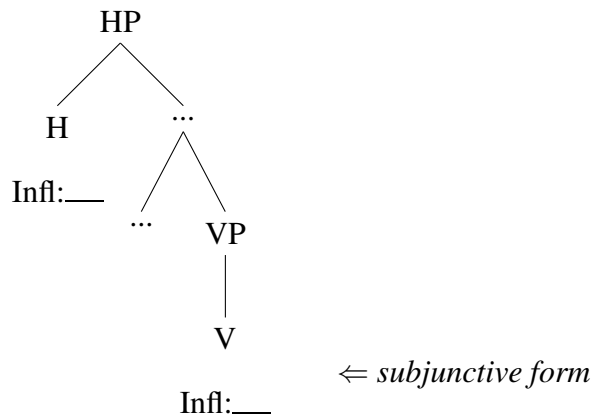

Recall from chapter 5 that independent evidence for the dependent valuation analysis of subjunctive forms was the fact that, in light verb constructions, the light verb and the main verb exhibit tense agreement. In the past tense, both the light verb and the main verb have a past tense inflection, though they appear in different forms: principal and subjunctive, respectively (17-a). In the present and future tense, the main verb is in the default, present subjunctive form (17-b)-(17-c).

(17) *Small Subjunctive: tense agreement*

- |   |   |
|---|---|
| <p>a. U-∅-qal-e:      wa-bala.<br/>         1s-PST-first-PST 1s-read.PST.SBJV<br/>         He first read.</p> | <p><i>Past → Past Subjunctive</i></p>       |
| <p>b. U-∅-qala      a-bale.<br/>         1s-PRES-first 1s-read.PRES.SBJV<br/>         He first reads.</p>     | <p><i>Present → Present Subjunctive</i></p> |
| <p>c. U-za-qala      a-bale.<br/>         1s-FUT-first 1s-read.PRES.SBJV<br/>         He will first read.</p> | <p><i>Future → Present Subjunctive</i></p>  |



further step of Infl-valuation, as a result of which the verb in subjunctive clauses is spelled out with the default present subjunctive morphology, irrespective of matrix tense.

An interesting question for future research is whether we can find instances of cross-clausal valuation in subjunctive clauses in other languages. For instance, it would be interesting to see if the phenomenon known as Sequence of Tense (SOT) involves this type of relation. In fact, it has been proposed that embedded tense morphology SOT contexts is the result of syntactic agreement with matrix tense features (Costantini, 2007; Giorgi, 2009). An example from Italian is shown in (21), where the matrix tense determines whether the embedded verb's form as a present or a past subjunctive.

*Italian* (Giorgi, 2009:7)

- (21) a. Gianni crede che Maria sia incinta.  
 Gianni believe.**pres** that Maria be.**pres.subj** pregnant.  
 'Gianni believes that Maria is pregnant'
- b. Gianni credeva che Maria fosse incinta.  
 Gianni believe.**pst** that Maria be.**pst.subj** pregnant.  
 'Gianni believed that Maria was pregnant'

Sequence of Tense is a complex phenomenon and whether dependent valuation is indeed involved in SOT constructions remains a question for future research.

Let us now turn to principal and participial forms. Their morphology is very similar and, in fact, they can only be distinguished when inflected for class 1 and class 2 subject agreement. As mentioned above, class 1 agreement prefix has the form *u-* in principal forms and *e-* in participles. Principal mood is the verb's form in matrix simple tenses, as shown in (22-a). When the same lexical verb appears in a compound tense, as in (22-b), it is the auxiliary that has the principal form, and the lexical verb is a participle.

- (22) a. uZodwa **u**-za-pheka.  
 1Zodwa 1s.**PRIN-FUT**-cook  
 'Zodwa will cook'

- b. uZodwa **u-za-be** e-pheka.  
 1Zodwa 1s.**PRIN-FUT-AUX** 1s.**PTCP-cook**  
 ‘Zodwa will be cooking’

I propose and argue below that principal forms are triggered in the immediate context of the peripheral topic head, while participles are the default verbal morphology.

A common property of preverbal subjects in Bantu is their topical nature (Bresnan & Mchombo, 1987; Letsholo, 2002). For this reason, preverbal subjects are often thought of as left-dislocated or moved to a left-peripheral topic position (Baker, 2003; Bliss & Storoshenko, 2009, a.o.). I have recently argued that subjects of indicative clauses in Ndebele indeed appear in a higher position than Spec,TP (Pietraszko, 2017; under review). I proposed that they surface as specifiers of an agreeing Top head (23).

(23) Subjects of indicative clauses are in Spec,TopP:

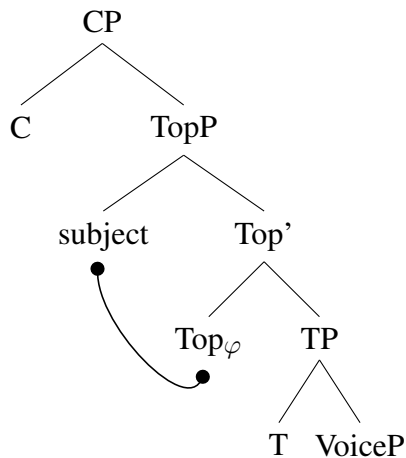

The position of subjects in indicative clauses is due to a  $\varphi$ -feature on Top. Like agreement with T, agreement with Top must cooccur with movement to the specifier of the agreeing head (Baker, 2003; Carstens, 2005). Thus, the principal subject agreement prefix is, I argue, the exponent of Top-agreement.

Crucially, subjects of subjunctive clauses are not topical. As I proposed in earlier work, the subjunctive periphery is reduced compared to the indicative periphery. Among other things, it

lacks a Top projection, and subjects of subjunctive clauses are in Spec,TP, as shown in (24).

(24) Subjects of subjunctive clauses are in Spec,TP:

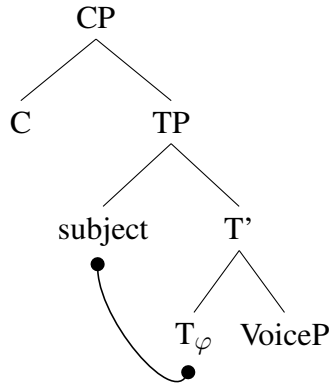

Evidence for this asymmetry between subjunctive and indicative clauses comes from the fact that subjects of indicative clauses are only compatible with a topic interpretation. For instance, they cannot be phrases that require narrow focus, such as *wh*-phrases (25-a) or nominals modified by the focus particle *kuphela* ‘only’ (25-b). As we see in their subjunctive counterparts in (26), subjects of subjunctive clauses are not restricted in this way.

(25) Indicative clause subject: \*focus

- a. \*U-cabanga ukuthi *ubani* u-pheke: inyama?  
2sg.s-think COMP 1who 1s-cook.PST 9meat  
(‘Who do you think cooked meat?’)
- b. \*Ngi-cabanga ukuthi *umama kuphela* u-pheke: inyama.  
1sg.s-think COMP 1mother only 1s-cook.PST 9meat  
(‘I think only mom cooked meat.’)

(26) Subjunctive clause subject: focus✓

- a. U-funa ukuthi *ubani* a-pheke inyama.  
2sg.s-want COMP 1who 1s-cook.SBJV 9meat  
(‘Who do you want to cook meat?’)
- b. Ngi-funa ukuthi *umama kuphela* a-pheke inyama.  
1sg.s-want COMP 1mother only 1s-cook.SBJV 9meat  
(‘I want only mom to cook meat.’)

Given this asymmetry, I propose that the form of the subject agreement prefix in indicative clauses is an allomorph in the context of Top (27-a). In a subjunctive form, the form *a-* of the class 1 prefix is conditioned by the feature DEP, while the participial form is the elsewhere exponent (27).

- (27) a.  $\varphi:1 \Leftrightarrow /u/ / \text{--- Top}$   
 b.  $\varphi:1 \Leftrightarrow /a/ / \text{--- DEP}$   
 c.  $\varphi:1 \Leftrightarrow /e/$

Suppose that the agreeing head of a participle in (22-b) is Asp. In that position, it meets neither the criteria for the principal form nor for the subjunctive form: it is neither in the context of Top nor DEP (28).

- (28)  $[\text{TopP Top}_\varphi \text{ principal-agr} [\text{TP T} [\text{AspP Asp}_\varphi \text{ participial-agr} [\text{VoiceP ... } ]]]]$

In other words, participial form arises when the verb is neither the highest verb in a clause with a TopP (principal) nor in the immediate context of an unvalued Infl-feature (subjunctive). The three contexts are summarized below.

- (29) Mood licensing positions in Ndebele:

a. **The subjunctive context:**

$V_{\text{Infl:---}}$  is c-commanded by head H with  $\text{Infl:---}$  and there is no H' such that H' has an Infl-feature and H' c-commands V but not H.

b. **The principal context:**

V is c-commanded by Top and there is no V' such that V' c-commands V but not Top.

c. **The participial context:** elsewhere

## 6.2.2 Cooccurrence of categories and metacategories

According to the Positional Licensing Hypothesis, features like past tense are independent of forms (indicative, participial or subjunctive). Inflectional categories correspond directly to Infl-features, but metacategories do not. They are positional variants of inflectional features (and other verbal morphology). This means that inflections and forms are defined on different tiers, and that they crosscut each other. If we look at the paradigm, the inflection–form crosscut is to a large extent observable for the overt morphology (30). In the table below, morphemes expounding inflections (categories) are in bold, while morphemes crosscutting forms (metacategories) are in italics.

(30) Inflections × forms (1s-cook)

	PRINCIPAL	PARTICIPIAL	SUBJUNCTIVE
no Infl value	<i>u</i> -phek-a	—	<i>a</i> -phek-e
Infl:FUT	<i>u</i> - <b>za</b> -phek-a	<i>e</i> - <b>za</b> -phek-a	<i>a</i> -phek-e
Infl:PST	<i>u</i> -phek- <b>ile</b>	<i>e</i> -phek- <b>ile</b>	<b>wa</b> -phek-a
Infl:IMPF	<i>u</i> -phek-a	<i>e</i> -phek-a	<i>a</i> -phek-e

A clear morphological crosscut can be observed in principal vs participial forms with past and future morphology. Both categories (future and past) have designated affixes (*za-* and *-ile*, respectively), and we see them in principal and participial forms alike. Form, on the other hand, is marked by the subject agreement prefix (*u-* or *e-*). Present tense and imperfective aspect have no specific morphology and they end up syncretic, but the form of imperfective inflection is still encoded on the agreement prefix. The subjunctive paradigm contains fewer contrasts: only past tense inflection is distinct. Thus, overt morphology is not enough to conclude that forms and inflections can fully cooccur in the subjunctive mood. In the rest of this subsection, I show that the present analysis of subjunctive predicts that all inflections are possible on verb in the subjunctive form and that therefore the lack of their expression must be a case of morphological neutralization. I then provide evidence from tense agreement blocking that, syntactically, subjunctive forms indeed can

host all possible Infl-values.

I argued in chapter 5 that the two subjunctive forms, past and unmarked, arise via Infl-agreement in lexical LV constructions. For instance, when T has the feature Infl:PST, both the light verb and the main verb will be valued as PST, and the main verb will additionally have a dependency feature, triggering subjunctive form (31).

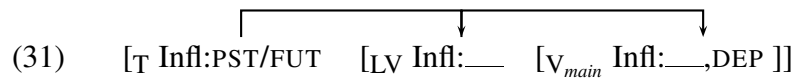

Even though I have been calling this phenomenon tense agreement, it is not agreement in tense features per se but agreement in Infl-features. As such, we expect not only features of T to be shared by the light verb and the main verb, but also Infl-features of other inflectional heads, namely T<sub>Perf/Prosp</sub> and Asp. This is expected to be the case when the lexical light verb appears, for instance, in the Future Imperfective, a compound tense (32).

- (32) U-za-be      e-phinda      a-pheke  
1s-FUT-AUX 1s-again.IMPF 1s-cook.SBJV  
'He will be cooking again'



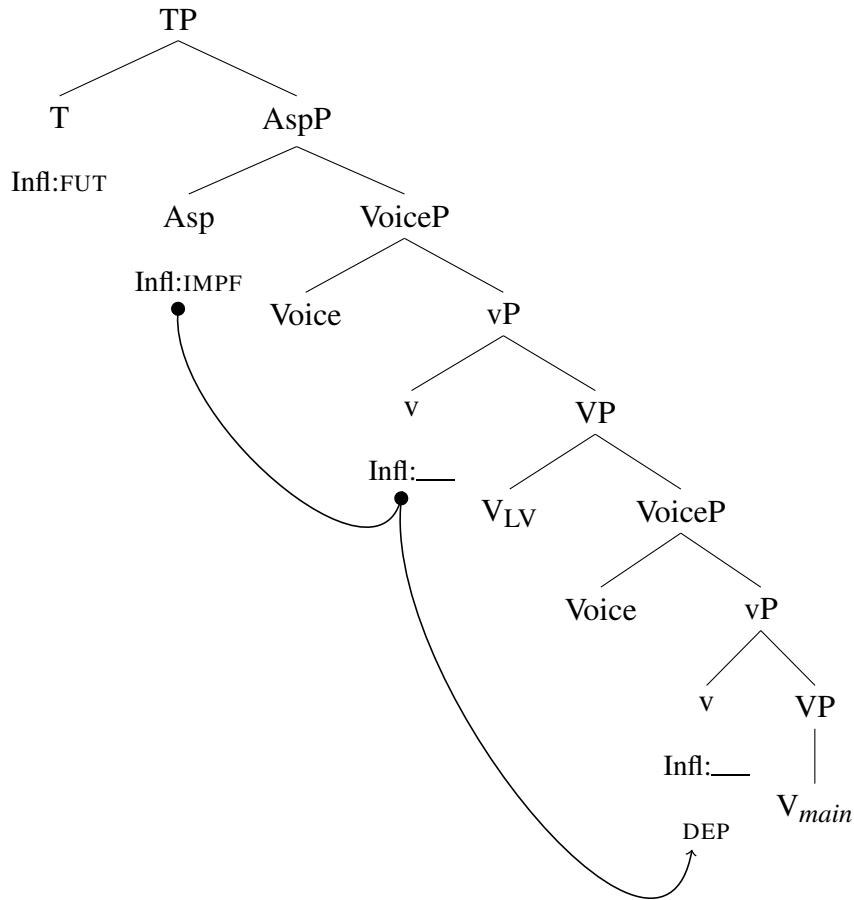

Since Asp is the most local head with an Infl-value, both the light verb and the main verb will be valued as IMPF. This means that, even though the main verb in (32) has the default subjunctive form, syntactically it hosts an imperfective inflection.

An alternative view, one that would more directly address syncretism in the subjunctive paradigm, would be to assume that the covariation we see in lexical LV constructions really is tense agreement, i.e. a direct relation between the subjunctive verb and T, rather than a relation between the subjunctive verb and the closest Infl-feature. Evidence against the direct tense agreement view comes from blocking effects caused by an inflection intervening between the main verb and T.

First, take a compound tense with past tense T and an intervening inflectional head, e.g. an imperfective Asp – a Past Imperfective tense. If the past subjunctive form is the result of a direct

relation between the subjunctive main verb and T, we expect to see a past subjunctive form on the main verb in the past imperfective scenario (33).

(33) Past subjunctive form licensed directly by T:

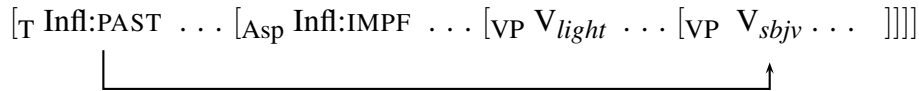

This prediction is wrong. A past tense T cannot trigger a past subjunctive form across an Asp head with a valued Infl-feature. Instead, the main verb has the default subjunctive form (34), the same we saw in Future Imperfective above (32).

(34) Past Imperfective → default subjunctive

U-∅-be e-phinda a-pheke/\*wa-pheka  
 1s-PST-aux 1s-again.IMPF 1s-cook.SBJV/\*1-cook.PST.SBJV  
 ‘He was cooking again’

This blocking effect is expected under the current proposal, according to which the subjunctive verb agrees not with T directly but with closest Infl-feature, which in this case is the unvalued Infl on the light verb, which itself receives a value from Asp (Infl:IMPF), as shown in (35).

(35) Past subjunctive blocked by a local Infl:

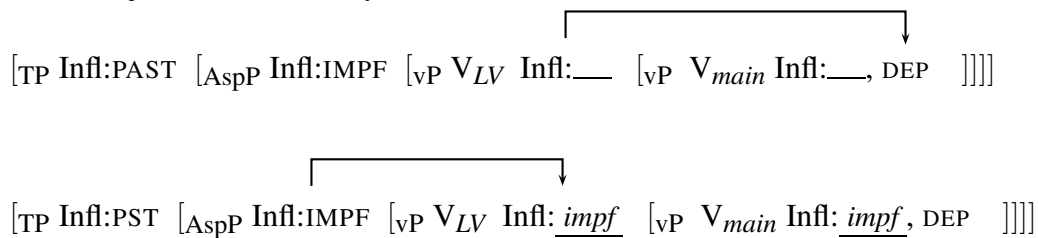

The lack of past subjunctive forms in imperfective tenses is compatible with the claim that inflection on subjunctive forms is the result of local Infl-agreement; specifically, that in imperfective

tenses, the subjunctive verb has its Infl-feature valued as IMPF. However, given that there is no imperfective-specific morphology (an imperfective subjunctive is the default subjunctive), the lack of past inflection on the subjunctive does not entail agreement with Infl:IMFP. Instead, Asp could act as a defective intervener for agreement between the subjunctive verb and T. Evidence that this is not the case comes from perfect tenses, such as the Future Perfect. As we see in (36), the main verb appears in the past subjunctive form, even though T has Infl:FUT.

- (36) U-za-be e-phinde: wa-pheka / \*a-pheke  
 1s-FUT-AUX 1s-again.PST 1s-cook.PST.SBJV / 1s-cook.SBJV  
 ‘He will have cooked again’

Like before, the past subjunctive main verb does not covary with tense (which has Infl:FUT), but in this case, the lack of covariation is not compatible with the defective intervention scenario. The main verb clearly agrees with Infl:PST on the perfect participle, as shown in (37). Lack of agreement with any inflection should result in a default subjunctive form, contrary to fact.

- (37) Past subjunctive licensed by a local Infl:

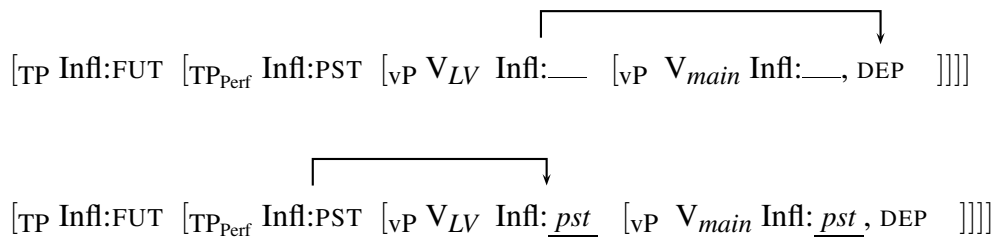

Thus, perfect tenses provide evidence that the inflectional covariation in subjunctive forms is the result of local Infl-agreement. This in turn means that the subjunctive form can cooccur with any Infl-feature, supporting the proposed differentiation of inflectional categories and metacategories.

To conclude, I argued in this subsection that metacategories are not defined by specific inflectional features. Rather, they are positional variants of these features. Evidence comes from the fact the categories and metacategories crosscut each other. A metacategory can comprise any

inflectional category – a fact visible to some extent from morphology and, more indirectly, from local interaction in Infl-agreement (blocking and feeding of past subjunctive in compound tenses). Conversely, every inflection can appear in any form. Again, some of the relevant distinctions are morphologically neutralized, but others are not. As we saw in (30), repeated below in (38), the past tense inflection is morphologically distinct in all three positional variants.

(38) Inflections × forms (1s-cook)

	PRINCIPAL	PARTICIPIAL	SUBJUNCTIVE
no Infl value	<i>u</i> -phek-a	—	<i>a</i> -phek-e
Infl:FUT	<i>u-za</i> -phek-a	<i>e-za</i> -phek-a	<i>a</i> -phek-e
Infl:PST	<i>u</i> -phek- <b>ile</b>	<i>e</i> -phek- <b>ile</b>	<b>wa</b> -phek-a
Infl:IMPF	<i>u</i> -phek-a	<i>e</i> -phek-a	<i>a</i> -phek-e

In the next subsection, I discuss another consequence of the separation of metacategories from Infl-features, namely the fact that they do not participate in inflectional periphrasis.

### 6.2.3 *Metacategories are irrelevant to inflectional periphrasis*

The overflow pattern of auxiliary use in Ndebele was argued in chapter 4 to be triggered by an increased amount of inflectional complexity. In particular, auxiliary insertion is triggered when a marked inflectional head cannot combine with the main verb via V-checking. The failure of synthesis is, then, directly related to the number of Infl-features in the syntax. If subjunctive, principal and participial morphology corresponded to Infl-features, e.g. Infl:SBJV, we would expect their presence to increase the inflectional complexity that triggers periphrasis. We do not see such an effect, however. For instance, subjunctive forms can have all possible Infl-features, as argued above. We have already seen that the subjunctive main verb in a LV-construction is synthetic whether it appears in a present tense (39-a) or in a past tense (39-b).



correct generalizations about periphrasis can be made without making reference to metacategories.

The irrelevance of mood distinctions to periphrasis can also be seen in Latin. Recall that the Latin verb can host up to two inflections, and in order to express three (passive voice, perfect aspect and tense), an auxiliary verb must appear. This generalization is true irrespective of mood, as we see below. The paradigm on the left is in indicative mood, and the one on the right shows the corresponding subjunctive forms.

(41)	Indicative	(42)	Subjunctive
	a. amabam love.1sg.PST 'I loved'		a. amarem love.1sg.PST 'I loved'
	b. amabar love.1sg.PASS.PST 'I was loved'		b. amarer love.1sg.PASS.PST 'I was loved'
	c. amaveram love.1sg.PERF.PST 'I had loved'		c. amavissem love.1sg.PERF.PST 'I had loved'
	d. amatus            eram love.PASS.PERF be.1sg.PST 'I had been loved'		d. amatus            essem love.PASS.PERF be.1sg.PST 'I had been loved'

Like in the indicative paradigm, the subjunctive allows only two inflections to be realized synthetically on the verb, whatever they are. Three inflectional features trigger periphrasis in both the indicative and the subjunctive. Thus, mood makes no detectable contribution to inflectional periphrasis in Latin either.

#### *6.2.4 Metacategories have a predictable distribution*

We saw in the previous subsections that treating subjunctive, participial and principal forms as corresponding to Infl-features is problematic given the attested cooccurrences of these forms and Infl-features without inflectional periphrasis. This problem only arises if we treat them as Infl-

features, but could be avoided if the relevant feature attribute is different, e.g. Mood:val, or if we view them as privative features (e.g. SBJV or PTCP). This alternative is not unproblematic either. I show in this subsection that the Positional Licensing analysis is more efficient in accounting for distribution of metacategories than an analysis which treats them as corresponding to any type of morphosyntactic features.

As discussed at length in chapter 5, participial and subjunctive forms in light-verb constructions have an entirely predictable distribution: subjunctive forms are selected by lexical light verbs, while participles are complements of functional light verbs (aspectual auxiliaries). An example pair is given in (43).

- (43) a. U-qala a-pheke *lexical LV* → SBJV  
 1s-first 1s-cook.**SBJV**  
 He first cooks
- b. U-hlezi e-pheka *functional LV* → PTCP  
 1s-constantly 1s-cook.**IMPF.PTCP**  
 He constantly cooks

I argued that the choice of complement morphology in LV-constructions should not be viewed as a lexical property of individual light verbs. This type of analysis would miss the generalization that the selected morphology systematically correlates with the LV's status as functional and lexical. In a theory of mood forms as morphosyntactic features, their distribution in LV constructions would have to be accounted exactly in this way. Each light verb would have to be specified as selecting a particular form. For instance, the verb *qala* 'first' in (43-a) would have a selectional feature SEL:SBJV, and the main verb would need to be generated with a matching category feature. The light verb *hlezi*, on the other hand, would select for a participle, and the main verb would need a participial feature to match its selector.

An alternative implementation of form selection would view it as agreement, similar to Infl-agreement. Suppose that the main verb has an unvalued Mood-feature. Light verbs, on the other hand, would have valued Mood features. The derivation for the lexical LV construction in (43-a)

under this analysis is shown in (44), and for the functional LV construction in (43-b) – in (45)

(44) Lexical LV constructions: a Mood-agreement analysis

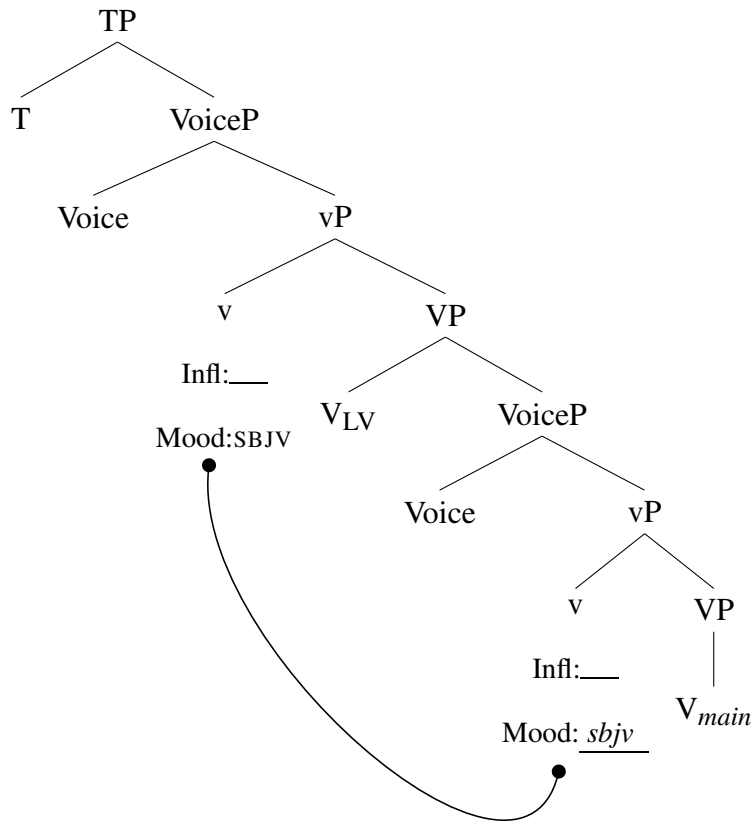



(45) Functional LV constructions: a Mood-agreement analysis

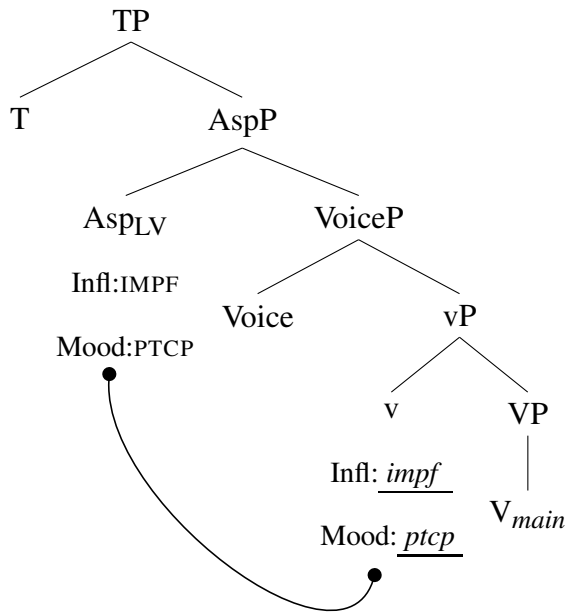

The Mood-agreement analysis amounts to making the same lexical stipulations as the selection-based analysis. Neither of them captures the generalization that subjunctive forms are complements of lexical LVs, while functional LV systematically combine with participles. We would perhaps expect to find a lexical LV with the feature Mood:PTCP, and a functional verb with a Mood:SBJV. The fact that we don't comes out as accidental under any analysis that treats participles and subjunctives as morphosyntactic features, selected for or assigned via agreement.

The picture is further complicated by participles occurring as complements of default auxiliaries (46-a) and as adjuncts (46-b).

- (46) a. U-za-be e-pheka.  
 1s-FUT-AUX 1s-cook.IMPF.PTCP  
 'He will be cooking'
- b. U-pheka e-hlabela.  
 1s-cook 1s-sing.IMPF.PTCP  
 'He cooks singing'

In order to account for participles as complements of default auxiliaries, we additionally need to posit that default auxiliaries select for or assign a participial feature to the main verb. This, in principle, is not problematic, but we do lose the connection between default auxiliaries and aspectual auxiliaries in this respect. Both were characterized as auxiliary verbs (i.e. non-projecting verbs), and they both combine with participles. Under the positional licensing account, this is predicted since, in both cases, the main verb is neither the highest verb in the clause (to receive a principal form) nor in the immediate context of an unvalued Infl-feature that would trigger a subjunctive form. Modeling the distribution of participles as assignment of participial features does not derive this correlation since it stipulates that default auxiliaries and aspectual auxiliaries happen to have the same selectional properties.

Accounting for participial morphology of adjuncts, as in (46-b), is especially challenging under this view since it is not obvious what the licenser/selector of the participial morphology would be. Let us assume that the adverbial modifier in (46-b) is a VoiceP adjunct of category Asp, as shown in (47).

(47) Imperfective participial as a modifier (46-b)

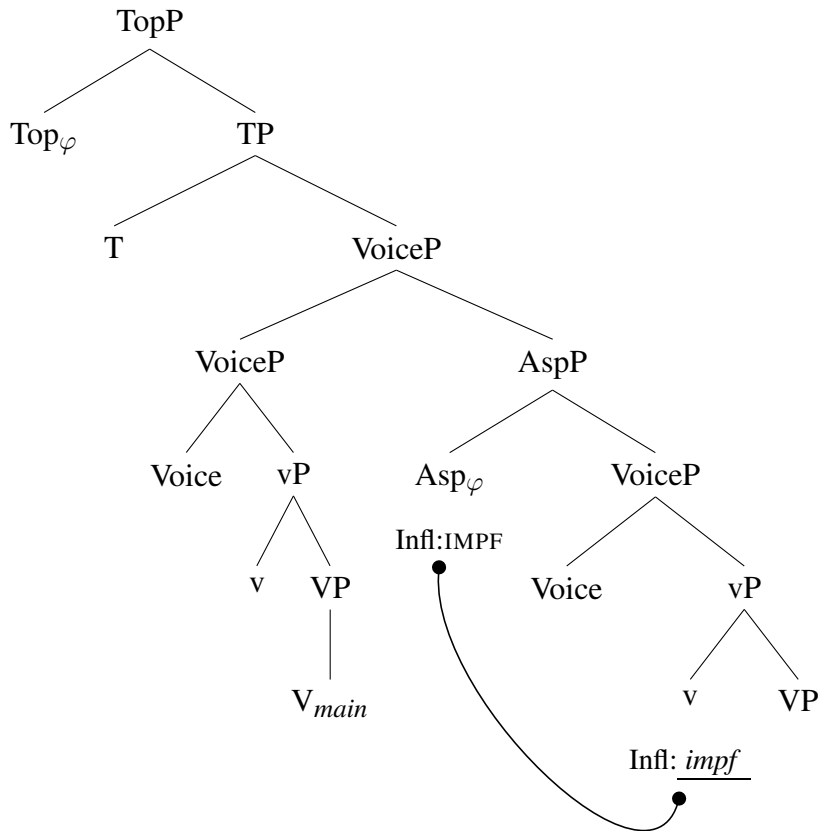

The imperfective inflection on the participial adjunct comes from the imperfective Asp head, but it is not clear where a participial feature would originate. Notice that, unlike in compound tense and aspectual auxiliary construction, the adjunct in (47) contains no auxiliary verb that would select for or assign the participial feature. Asp itself cannot be seen as serving this function either since Asp does not require participial complement across the board (recall that the present imperfective tense is synthetic and there the verb is not a participle, but rather has a principal form). Once again, the positional licensing view accounts for the fact that an AspP adjunct must be a participle. Since the morphological difference between principal and participial forms reduces to subject agreement allomorphy, it suffices to compare the position of agreement probes. As proposed earlier in this section, the principal form of the class 1 agreement prefix, namely *u-*, is the allomorph triggered

in the context of Top. The adjunct does not contain a topic head and therefore the elsewhere form, that is *e-*, must appear.

In sum, an approach to mood morphology according to which it corresponds to morphosyntactic features must resort to stipulations about the distribution of participial, subjunctive and principal forms, without accounting for the generalizations that they systematically appear in certain structural positions. Principal forms appear as the highest verb in an indicative clause, subjunctive forms are triggered by an immediate context of an unvalued Infl-feature, while participial morphology has the elsewhere distribution.

### 6.2.5 Conclusion

I proposed in this section a classification of verbal morphology into inflectional categories, which correspond to Infl-features, and metacategories – morphology not encoded by morphosyntactic features, but rather licensed positionally, triggered in certain syntactic configurations. The positional licensing hypothesis allows for a more explanatory account of the distribution of such forms as subjunctives and participles in Ndebele, which show no signs of selectional idiosyncrasy and are entirely predictable from their syntactic context. A question remains about subjunctive clauses, whose selection *is* to some extent idiosyncratic: subjunctive CPs are selected by certain embedding predicates by not others. However, subjunctive morphology in clausal contexts typically correlates with a special type semantics and I believe that the selection of a subjunctive, i.e. a temporally deficient/dependent clausal complement should be viewed (and it often is) as related to semantic properties of the embedding predicate. The subjunctive *morphology*, I argue, is not what's selected by those predicates; it is the temporal deficiency (and/or other semantic properties of subjunctive clauses) that such predicates require. The subjunctive *form* is only a morphological reflex of how this type of deficiency is encoded morphosyntactically, namely by an unvalued Infl-feature on the subjunctive T. The relationship between the subjunctive-like meaning and subjunctive morphology is, then, indirect. Lexical LV constructions provide evidence for this indirect link between the

semantics of subjunctive CPs and subjunctive morphology. The subjunctive form of complements of lexical LVs does not correlate with anything we could call subjunctive-like semantics. These are small constituents (VoicePs) which often appear in an indicative clause. There is no evidence for a subjunctive clause periphery in small subjunctives and there is no obvious sense in which the adverbial meanings of lexical light verbs would form a semantic natural class with predicates typically embedding subjunctive clauses. In other words, subjunctive clauses constitute just one possible inflectionally deficient context in which dependent valuation takes place triggering subjunctive morphology.

### **6.3 V-chains and the distribution of $\varphi$ -agreement**

In this section, I focus on  $\varphi$  agreement; in particular, on the distribution of subject agreement prefixes in multi-verb constructions. When analyzing each type of multi-verb constructions, I pointed out the generalization that every verbal element, lexical or auxiliary, is preceded by a subject agreement prefix. The question which now arises concerns the syntactic loci of agreement probes in multi-verb constructions which give rise to this generalization. I first explain why simply "placing"  $\varphi$  probes on certain functional heads is problematic for languages like Ndebele (with the overflow pattern) (section 6.3.1) and suggest a way in which V-checking can help us determine the position of an agreement prefix in various multi-verb constructions (sections 6.3.2 and 6.3.3). In section 6.3.4 I address a few remaining issues.

#### *6.3.1 The inconsistent distribution of $\varphi$ -probes*

We have identified three types of multi-verb constructions in Ndebele: compound tenses (48-a), functional LV constructions (48-b) and lexical LV constructions (48-c). One property common to all three types is that every verbal element is fully inflected for subject agreement.

- (48) a. **U-∅-be**      **u-pheka**      *default aux + V*  
 2sg.s-PST-AUX 2sg.s-cook.IMPF  
 You were cooking.
- b. **U-se**      **u-phek-ile**      *functional LV + V<sub>main</sub>*  
 2sg.s-already 2sg.s-cook-PST  
 You have already cooked.
- c. **U-qala**    **u-phek-e**      *lexical LV + V<sub>main</sub>*  
 2sg.s-first 2sg.s-cook-SBJV  
 You cook first.

Descriptively, there is an Agr node on every verbal element in (48). The standard assumption is that agreement morphology is, in the normal case, indicative of the presence of an agreement probe in syntax. According to this mapping between  $\varphi$ -probes and AGR-prefixes, we infer that each construction in (48) contains two  $\varphi$ -probes in their structure. Assuming that this probe-affix mapping is correct for  $\varphi$ -agreement on verbs, a question arises as to where exactly the multiple probes are located. One common view is that  $\varphi$ -probes are a property heads such as T, and perhaps other inflectional heads like Asp. In this subsection I show that it is very difficult to identify a set of inflectional heads which host  $\varphi$ -probes in Ndebele.

### $\varphi$ on T and Top

I assumed throughout the thesis that subject agreement prefixes in simple tenses spellout  $\varphi$ -probes on T. In the previous section, I amended this assumption and proposed that T is the location of subject agreement only in subjunctive clauses, while subject agreement in indicative clauses is agreement in a topic head. Importantly, T does not show  $\varphi$ -agreement independently of Top in indicative clauses. In other words, we do not see two agreement prefixes in indicative clauses, one on T and one on Top, but only one. We thus conclude that T does not consistently host  $\varphi$ -agreement. It does so only in the absence of the higher agreeing head, namely Top.

$\varphi$  on  $T_{\text{Perf/Prosp}}$  and Asp

Now consider agreement on participles in compound tenses. Given affix order, it appears as a prefix on the inflectional head defining the participle: on  $T_{\text{Prosp}}$  in a prospective tense (49-a), on  $T_{\text{Perf}}$  in a perfect tense (49-b), and on Asp in an imperfective tense (49-c).

- (49) a. U- $\emptyset$ -be e-za-bala  
 1s-PST-AUX 1s-FUT-read  
 'He was going to read'

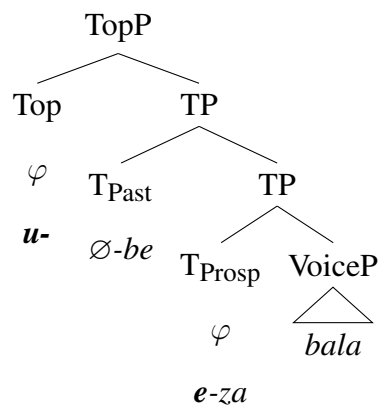

- b. U- $\emptyset$ -be e-bal-ile  
 1s-PST-AUX 1s-read-PST  
 'He had read'

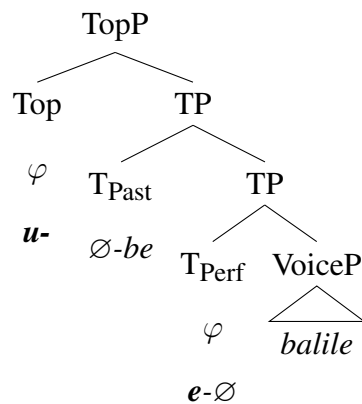

- c. U- $\emptyset$ -be e-bala  
 1s-PST-AUX 1s-read.IMPF  
 'He was reading'

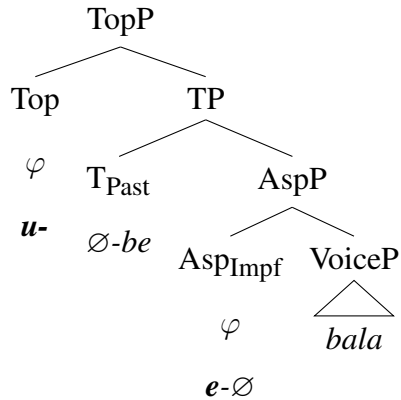

Admittedly, the evidence for the hypothesized position of  $\varphi$ -probes on participles is only clear in prospective participles, in which the agreement prefix precedes the lower future tense prefix *za*. Since  $T_{\text{Perf}}$  and Asp have null exponents, it is in principle possible that the  $\varphi$ -probes are located on some lower head, but there is no evidence for that and I will assume the distribution above for consistency with prospective participles. Thus, in addition to Top and T,  $T_{\text{Perf/Prosp}}$  and Asp bear  $\varphi$ -probes.

A challenge for positioning  $\varphi$ -probes on  $T_{\text{Perf/Prosp}}$  and Asp comes from the overflow pattern of auxiliary use in Ndebele. Not all perfect, prospective and imperfective tenses are periphrastic. When T is unmarked (present tense), the expression is synthetic and only one subject agreement prefix appears. As we see in (50), the sole agreement prefix in these forms is the principal allomorph of class 1, namely *u-*, not the participial one (*e-*), suggesting that the agreement morpheme is in Top.

- (50) a. U- $\emptyset$ -za-bala  
 1s-PRES-FUT-read  
 'He is going to read'



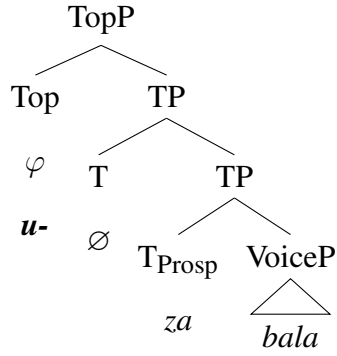

- b. U- $\emptyset$ -bal-ile  
 1s-PRES-PST-read-PST  
 'He has read'

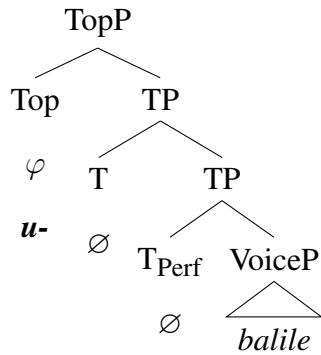

- c. u-ya- $\emptyset$ -bala  
 1s-PRES.DSJ-IMPf-read.IMPf  
 'He is going to read'

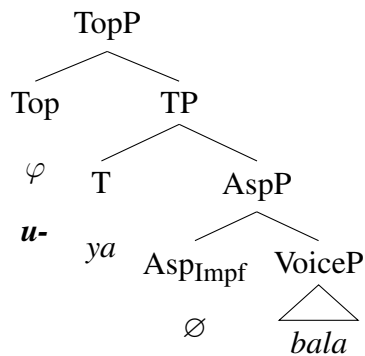

It appears that the inflectional heads T<sub>Perf/Prosp</sub> and Asp do not host an agreement probe just in case T is unmarked. In this respect, they are another instance of an inconsistent association of  $\varphi$

probes with functional heads (in addition to T, as discussed in the previous subsection).

Based on the behavior of T and lower inflectional heads with respect to agreement, two generalizations emerge. First, the presence of an agreement prefix correlates with the number of verbal elements. This is, what we observe is the overflow problem. Asp, for example, only bears a probe if there is an auxiliary verb higher in the structure. And second, if there are two heads which can in principle bear an agreement probe, we observe agreement on the higher head only. This is what we saw in indicative clauses, where the availability of an agreeing Top head renders no agreement on T.

In the next section I show that positions of subject agreement prefixes can be predicted from the size of head chains formed by V-checking – the selection mechanism responsible for synthesis and periphrasis, as discussed in chapter 4.

### 6.3.2 *A $\varphi$ -probe on top of every V-chain*

I proposed in chapter 4 that every functional head in a verbal extended projection has a selectional V-feature, [SEL:V], which must be checked by an element of the verbal category (a lexical verb, a functional verb or a default auxiliary). Subsequent functional heads can check their V-feature against the main verb for as long as long as the verb is active (has an unvalued Infl-feature), or if the inflectional heads are unmarked, in which case they are not subject to the activity condition. If all heads in a clause check their V-feature against the main verb, the expression is synthetic. As an example, consider V-checking in a simple future tense (51).

- (51) U-za-bala  
 1s-FUT-read  
 He will read

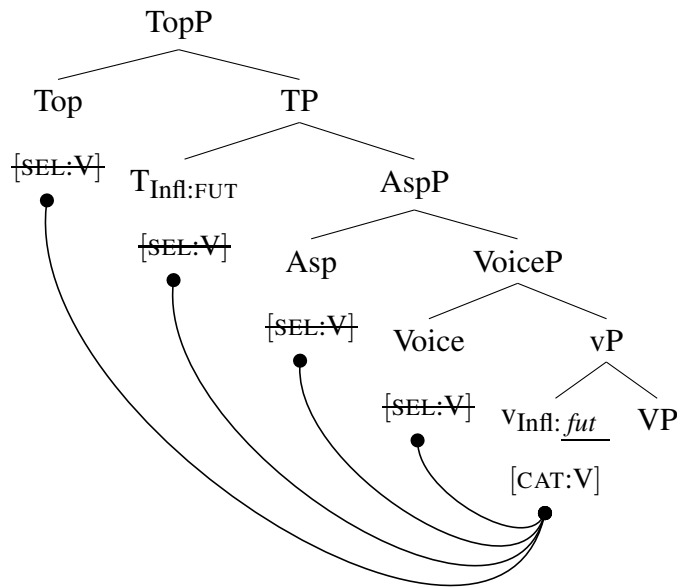

Note that I added TopP in (51), following the amendment of the clause structure according to which indicative clauses, unlike subjunctive clauses, contain an agreeing topic head. I propose that Top also has a selectional V-feature but has no Infl-feature.

I will use the term *V-Chain* to refer to the sequence of heads connected by a V-checking relation. The minimal V-chain consists of a head of category V and one selecting head. The V-chain in (51) consists of five heads, as shown in (52).

- (52) V-Chain in (51): ⟨Top, T, Asp, Voice, v⟩

I propose that the distribution of agreement probes in Ndebele can be correctly predicted from the size of V-Chains. In particular, an agreement probe is located on the highest head of every V-Chain (53).

(53) **The agreement–V-Chain generalization**

The highest head in a V-chain is the locus of a  $\varphi$ -probe.

This generalization captures the fact that in indicative clauses, such as (51), it will be Top, not T, that agrees with the subject. T can, in principle host  $\varphi$ -agreement, but only when it is the highest head in the chain. This is true in subjunctive clauses, which lack a TopP. Thus, this generalization naturally captures the difference between indicative and subjunctive clauses with respect to subject agreement.

The second challenge I discussed was the overflow pattern. Heads such as Asp or T<sub>Perf</sub> sometimes host an agreement prefix, and other times they don't. In light of the proposed analysis of periphrasis, this apparently inconsistent association with a  $\varphi$ -probe is consistent with the generalization in (53). Heads like Asp surface with an agreement prefix only when they are the highest head in a V-Chain. I illustrate this with imperfective tenses, but the logic for other compound tenses is the same. In a past imperfective tense, there are two marked inflectional heads: T and Asp, as shown in (54). Recall that, in such a scenario, T cannot check its selectional V-feature against the main verb and it triggers last-resort insertion of an auxiliary verb.

- (54) U-Ø-be e-bala  
 1s-PST-AUX 1-read.IMPf  
 'He was reading.'

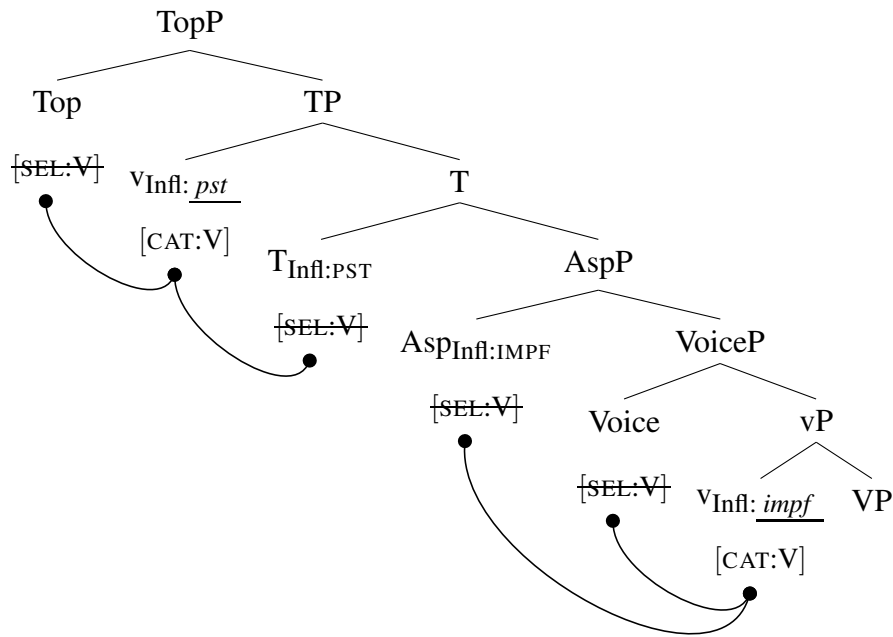

The selection patterns in (54) result in the formation two two V-Chains: one linked with the main verb and one linked with the auxiliary verb (55). An agreement probe is located on the highest head of each chain, that is Asp and Top.

- (55) V-Chains in (54):
- a.  $\langle \text{Asp, Voice, v} \rangle \Rightarrow \varphi$  on Asp
  - b.  $\langle \text{Top, v, T} \rangle \Rightarrow \varphi$  on Top

In contrast, a present imperfective tense has only one V-Chain as it is a synthetic tense. There, T is unmarked and so it does not trigger auxiliary insertion (56). The V-Chain comprises all the inflectional heads with a selectional V-feature in that clause (57) and agreement appears only on Top – the highest head in the chain.

- (56) U-ya-bala  
 1s-PRES.DSJ-read.IMPF  
 'He is reading'

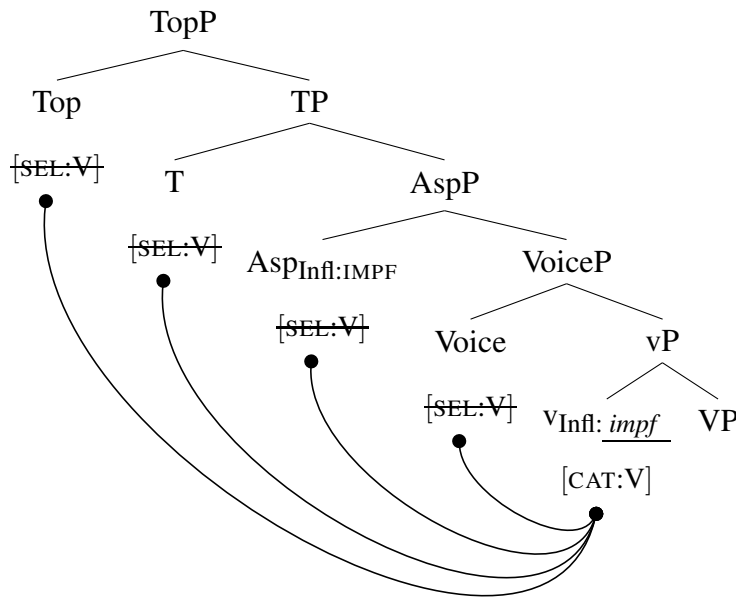

- (57) V-Chain in (56):  $\langle \text{Top, T, Asp, Voice, v} \rangle \Rightarrow \varphi$  on Top

Thus, the Agreement-V-Chain generalization correctly captures the inconsistent appearance of  $\varphi$ -probes in heads such as Asp, caused by the overflow pattern of auxiliary use.

I have shown in this section that the distribution of subject agreement probes correlates directly with the size of V-Chains created by an independently needed mechanism of V-checking. It correctly derives the apparently inconsistent distribution of  $\varphi$ -probes in compound and simple tenses, and it accounts for the fact that in indicative clauses, which have an agreeing Top head, T does not have its own subject agreement prefix. In the next section, I extend this to other contexts of subject agreement, namely light-verb constructions.

### 6.3.3 Further predictions: agreement in LV-constructions

In addition to heads like Top, T and Asp, subject agreement prefixes appear on smaller constituents, such as VoiceP. This is the case in lexical light-verb constructions, in which the main verb complement of the LV is often as small as a VoiceP, as argued in chapter 5.

Let us consider lexical LV constructions first. Lexical light verbs, like the one in (58), typically select for a VoiceP, which itself is a projection of the main verb.

- (58) U-za-phinda a-pheke.  
1s-FUT-again 1s-cook.SBJV  
'He will cook again'

Assuming that  $\varphi$ -probes are properties of functional heads, the agreement prefix on the small subjunctive, namely the prefix *a-*, must be a property of some head within the VoiceP, for instance of Voice. However, Voice does not always bear a  $\varphi$ -probe, as evident from many other constructions, for instance simple tenses. It appears that Voice is only associated with an agreement probe when it is selected by a light verb – another instance of an inconsistent association.

The Agreement-V-Chain generalization correctly captures this apparent inconsistency. In lexical LV constructions, the lower Voice head is the highest head of the V-Chain linked to the main verb. The lexical LV forms its own V-Chain with higher functional heads in the clause (59).

(59) The structure of (58)

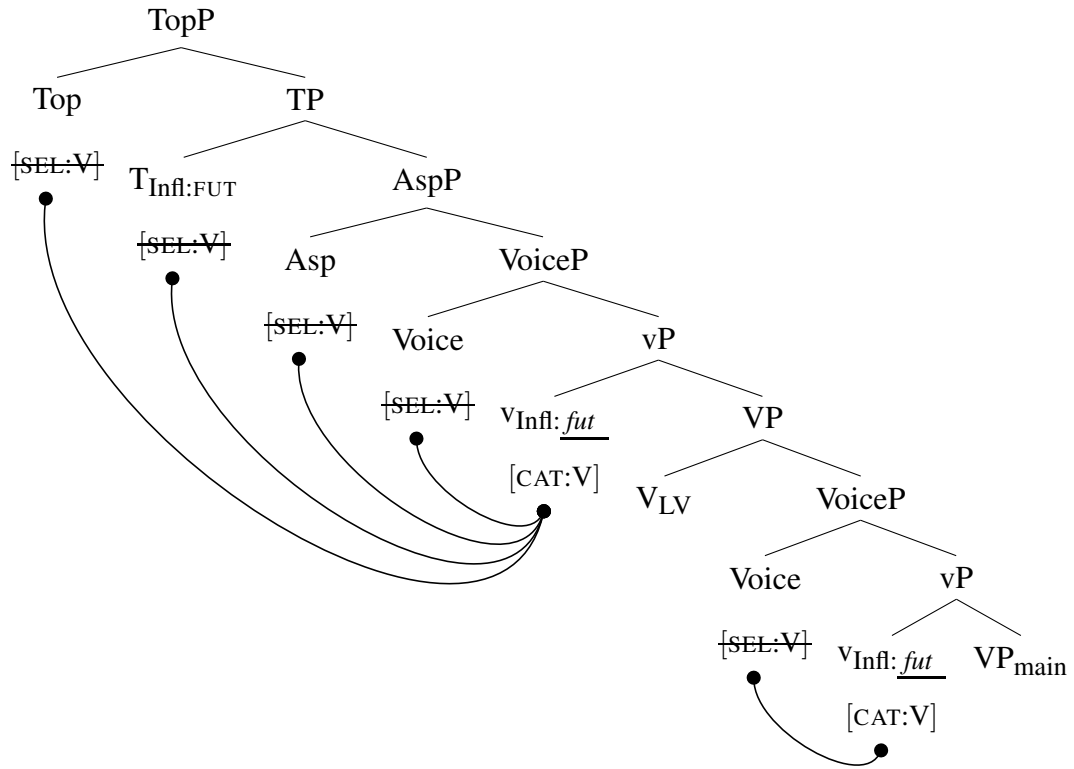



(60) V-Chains in (59):

- a. Light verb:  $\langle \text{Top, T, Asp, Voice, v} \rangle \Rightarrow \varphi$  on Top
- b. Main verb:  $\langle \text{Voice, v} \rangle \Rightarrow \varphi$  on Voice

The correlation of  $\varphi$ -probe position and V-Chain size is additionally observed in cases when the LV's complement is negated. Recall from chapter 5 that many lexical LVs can optionally select for a NegP, whose head is projected right above Voice and is spelled out as the low negation prefix *nga-*, as shown in (61).

- (61) U-za-phinda a-nga-pheki.  
 1s-FUT-again 1s-NEG-cook.SBJV.NEG  
 'He will again not cook'

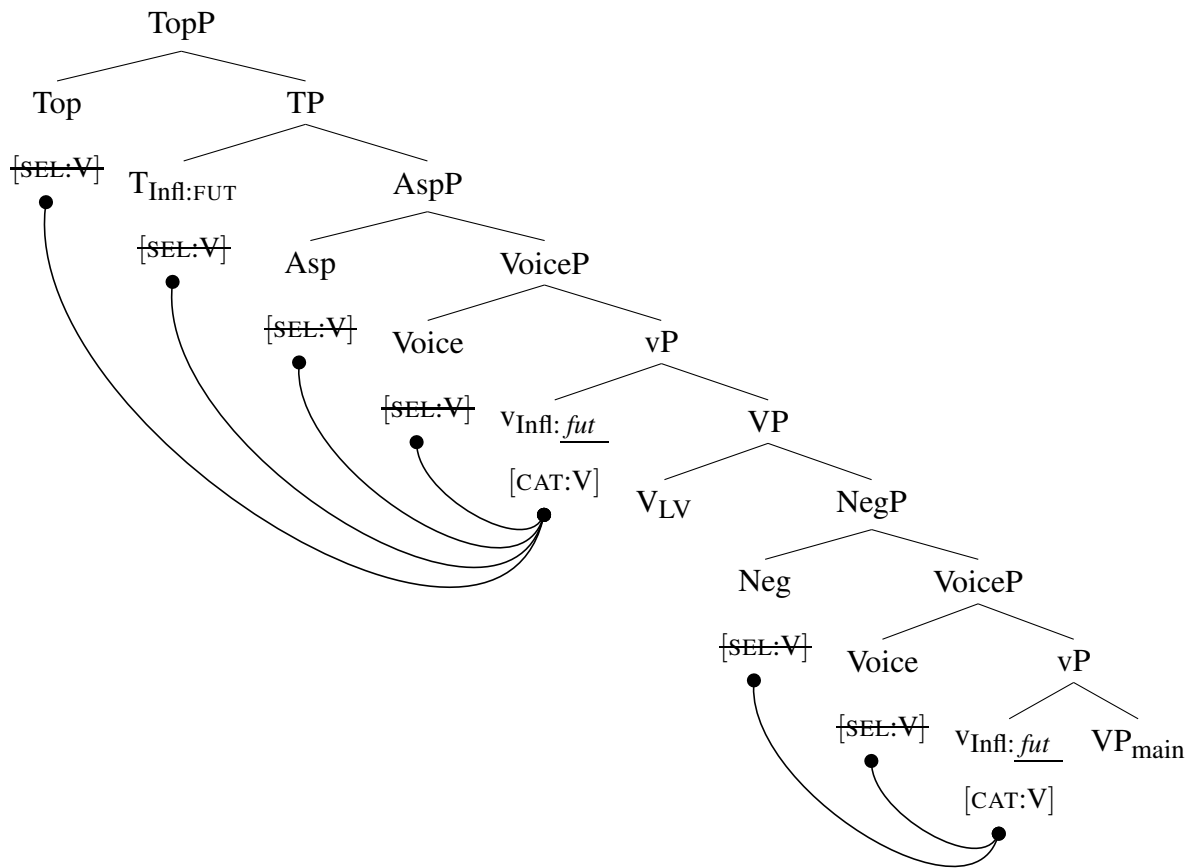

Note that in the presence of negation, the agreement prefix of the small subjunctive complement surfaces as a prefix on the negation marker, suggesting that the agreement probe is higher than on Voice. The Agreement-V-Chain generalization predicts that, when NegP is present, the  $\varphi$ -probe in the small subjunctive complement is located in Neg, not Voice, since now Neg is the highest head in the V-Chain (62).

(62) V-Chains in (61):

- a. Light verb:  $\langle \text{Top, T, Asp, Voice, v} \rangle \Rightarrow \varphi$  on Top
- b. Main verb:  $\langle \text{Neg, Voice, v} \rangle \Rightarrow \varphi$  on Neg

Thus, Voice is another instance of a head inconsistently associated with a  $\varphi$ -probe, and one which probes only in case it is the highest head in a V-Chain.

Finally, let us return to an issue I mentioned in chapter 4 concerning the distribution of agreement prefixes with aspectual verbs. Recall that *lokhe* ‘still’, an aspectual auxiliary associated with an imperfective aspect head, has an affixal counterpart, *sa-* ‘still’. The two expressions of ‘still’ are shown in (63).

- |      |    |  |    |  |
|------|----|--|----|--|
| (63) | a. | Ngi- <b>lokhe</b> ngi-pheka<br>1sg-still 1sg-pheka<br>‘I am still cooking’ | b. | Ngi- <b>sa-</b> pheka<br>1sg-still-cook<br>‘I am still cooking.’ |
|------|----|--|----|--|

The meanings introduced by *lokhe* and *sa-* are judged as identical and I assume that they both realized an Asp head with an imperfective-like semantics.<sup>2</sup> That is to say, *lokhe* and *sa-* have the same syntax, schematized in (64), and they differ in whether Asp<sub>Impf</sub> is verbal or not.

---

2. It is worth noting that *lokhe* and *sa* can cooccur. Relatedly, the two aspectual verbs associated with and imperfective Asp head (*lokhe* ‘still’ and *hlezi* ‘constantly’) can also cooccur. As I suggested in chapter 3, this cooccurrence is likely an indication that the clause structure in Ndebele is more articulated than I assume here and contains at least two Asp heads with an imperfective-like semantics. I assume that the cooccurrence of *lokhe* and *sa-* is another piece of evidence for this claim. I do not incorporate this detail since it is largely irrelevant to the discussion. What’s important in this section is the assumption that both *lokhe* and *sa-* indicate a present of an aspectual head that can, in principle, host an agreement prefix, as discussed earlier in this section. For this reason, I collapse *lokhe* and *sa-* as Asp<sub>Impf</sub>, as I did for *lokhe* and *hlezi*.

(64) Asp<sub>Impf</sub> with a verbal or affixal exponent (*lokhe* vs *sa* ‘still’)

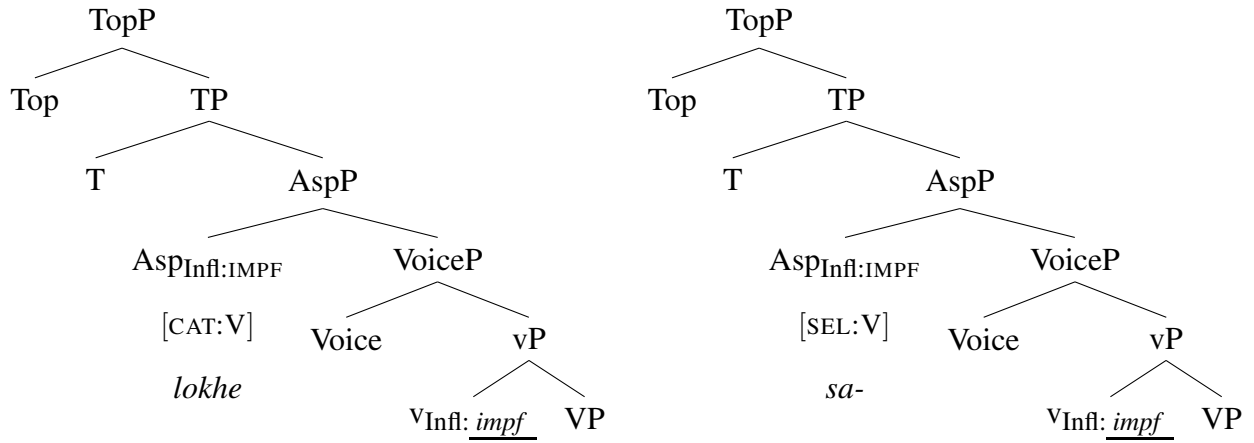

What the two expressions of ‘still’ have in common is their association with a marked aspectual head (with the feature Infl:IMPF). Evidence for this syntactic similarity is the fact that neither *sa-* nor *lokhe* can synthetically combine with marked tense. As shown in (65) and (66), a marked tense feature requires auxiliary support.

- (65) a. \*Ngi-za-lokhe ngi-pheka  
 1sg-FUT-still 1sg-cook  
 (‘I will still be cooking’)
- b. Ngi-za-be ngi-lokhe ngi-pheka  
 1sg-FUT.AUX 1sg-still 1sg-cook  
 ‘I will still be cooking’

- (66) a. \*Ngi-za-sa-pheka  
 1sg-FUT-still-cook  
 (‘I will still be cooking’)
- b. Ngi-za-be ngi-sa-pheka  
 1sg-FUT.AUX 1sg-still-cook  
 ‘I will still be cooking’

The inability to combine with marked tense is an indicator that both *sa* and *lokhe* have a marked Infl-feature. Where they differ is in the distribution of agreement prefixes: the complement of

*lokhe* is a verbal element preceded by a subject agreement prefix; the complement of *sa* is a bare verb stem, with no agreement. This difference falls out directly from their categorial status and the Agreement-V-Chain generalization. Being a functional verb, *lokhe* has a category V feature and no selectional V-feature. The opposite is true for *sa-*, which is a non-verbal exponent of an imperfective Asp head. This, in turn, affects the way in which V-selection proceeds and results in different V-Chain formation. When Asp<sub>Impf</sub> is verbal, the V-Chain linked to the main verb ends at the head right below Asp, namely Voice. The aspectual verb forms its own V-Chain with T and Top (67).

- (67) U-lokhe e-pheka.  
 1s-still 1s-cook.IMPF  
 'He is still cooking'

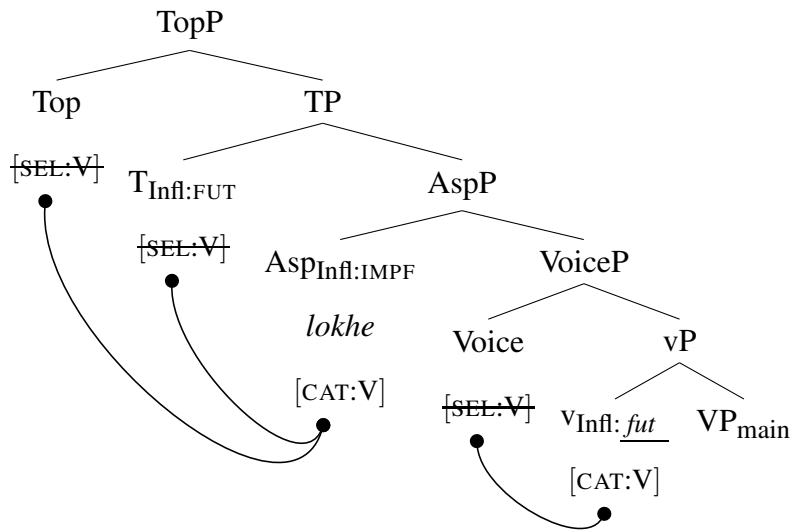

Since the structure in (67) contains two V-Chains, shown in (68), the expression contains two agreement probes, on the highest head of each one.

- (68) V-Chains in (67):
- a. Aspectual auxiliary:  $\langle \text{Top, T, Asp} \rangle \Rightarrow \varphi$  on Top
  - b. Main verb:  $\langle \text{Voice, v} \rangle \Rightarrow \varphi$  on Voice

Since *sa-* is a non-verbal exponent of  $\text{Asp}_{\text{Impf}}$ ,  $\text{Asp}$  behaves like any other inflectional head: it selects for a V. As a result, a present tense expression with *sa-* forms only one V-Chain and consequently contains one agreement prefix (70).

- (69) U-sa-pheka.  
 1s-still-cook.IMPF  
 ‘He is still cooking’

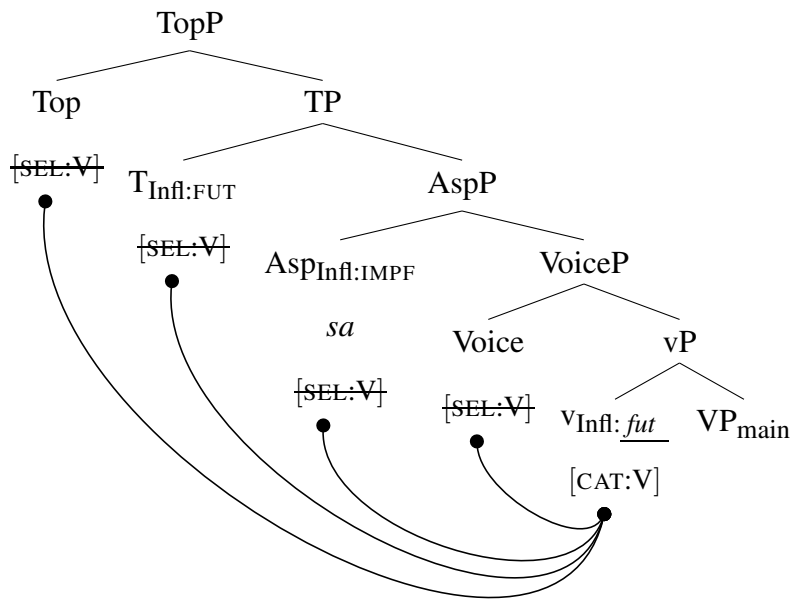

- (70) V-Chain in (69):  $\langle \text{Top}, \text{T}, \text{Asp}, \text{Voice}, \text{v} \rangle \Rightarrow \varphi$  on Top

In sum, the realization of ‘still’ as verbal or affixal constitutes yet another case in which  $\text{VoiceP}$  inconsistently bears an agreement probe. This variability is correctly derived by the generalization that the syntactic locus of  $\varphi$ -probes is determined by V-checking and correlates directly with the number and size of V-Chains formed in each structure.

### 6.3.4 Remaining questions

The Agreement–V-Chain generalization allows us to capture the apparently inconsistent association of subject agreement probes with functional heads in Ndebele simple and complex verbal expressions by relating it to the number and size of head chains formed by of V-selection. Positing a systematic link between V-Chains and  $\varphi$ -probes has certain assets: in addition to accounting for the variable distribution of  $\varphi$ -probes in a number of different syntactic contexts, the generalization is stated in terms of an independently motivated inflectional dependency, namely V-Checking. As such, it constitutes a theoretically precise version of the observation that the number of subject agreement prefixes corresponds to the number of verbs in an expression. But it does more than provide a theoretical frame. It makes predictions about the exact position of an agreement prefix, relative to other verbal morphology (recall the variability in negative and positive complements of lexical LVs). Nonetheless, some issues remain, and I would like to discuss two of them here. The first question concerns the exact mechanism responsible for such variable distribution of agreement prefixes. The other relates to allomorphy in subject agreement prefixes and in particular, the apparent lack of locality typically required for allomorphy.

If  $\varphi$ -probes are indeed distributed according to the Agreement-V-Chain generalization, a question arises as to where such probes originate. It is often assumed that  $\varphi$ -probes are a lexical property of certain functional heads, e.g. T. But a lexical association of  $\varphi$ -probes and functional heads is in conflict with its inconsistency. If the locus of  $\varphi$ -probes is determined by V-Chain size, and V-Chain formation is a dynamic, derivational process, the distribution of  $\varphi$ -probes comes out as a derivational, not a lexical, phenomenon. A possible way to think about the origin of  $\varphi$ -probes is as a property of V-Chains, not of individual functional heads (71).

(71) V-Chain:  $\varphi \langle \dots H_3, H_2, H_1, V \rangle$

This hypothesis avoids the problem of inconsistent association of  $\varphi$ -probes with functional heads because  $\varphi$  in (71) not a property of any particular head. Nonetheless, this further requires defining

V-Chains in such a way that their  $\varphi$ -probe will be associated with the highest head.

Alternatively, we can assume that  $\varphi$ -probes *are* properties of functional heads, of all of them. This was proposed by Baker & Willie (2010) for Ibibio, where we find multiple overt agreement morphemes in apparently synthetic expressions. Suppose that, like in Ibibio, every functional head in Ndebele has a  $\varphi$ -probe. Since an agreement marker only surfaces on the highest head of a V-Chain in Ndebele, the Agreement-V-Chain generalization still has to play a role, but it would be a different one than in the first hypothesis, where  $\varphi$ -probes were treated as properties of V-Chains. Here,  $\varphi$ -probes are properties of functional heads, but they are inactive or invisible in all positions but the highest position in the V-Chain. In other words, V-Chain formation would determine which functional head can probe. Additionally, I'd like to point out that the Agreement-V-Chain generalization need not be a syntactic one, and it might instead be a morphological constraint. That is, it is in principle possible that all functional heads in Ndebele have active  $\varphi$ -probes, like in Ibibio, and that the restriction to the highest head of a V-Chain is a constraint on spellout of agreement morphemes. Finally, a question arises about the nature of agreement with the subject DP: does each probe agree directly with the subject DP or do the inflectional heads agree with each other, as proposed e.g. by Baker & Willie (2010) and Henderson (2006). The precise theoretical implementation of the Agreement-V-chain generalization is an issue I must leave for the future.

Another puzzling issue regarding  $\varphi$ -agreement in Ndebele (and in many related languages) is the question of allomorphy in subject agreement prefixes, and specifically, the kind of locality conditions involved. In short, allomorphy appears to be non-local. As I show below, the problem is related in part to the prefixal nature of agreement morphology in Bantu and in part to the assumptions I have been making about word formation.

I illustrate the problem with subjunctive allomorphs of class 1 subject agreement prefixes. Recall that Ndebele has two types subjunctive complements: small subjunctives (VoicePs) and clausal subjunctives. In both types, the allomorph of class 1 agreement prefix is *a-*. Importantly, given the Agreement-V-Chain generalization, the different size of these two subjunctive constituents entails

that they have  $\varphi$ -probes in different positions: in clausal subjunctives, agreement is on T, while in small subjunctives it is on Voice. Let us consider clausal subjunctives first. The structure in (72) shows the assumed extent of head movement in the verbal domain: the verb moves as far as Voice but does not move to adjoin to higher inflectional heads which are realized as prefixes (Julien, 2002). Rather, I assumed, following Julien, that prefixal heads are not in a complex head with the verb stem and are essentially realized as free morphemes, phonologically concatenated on the verb stem. Note however, that the exponent *a-* of class 1 agreement is specific to the subjunctive contexts, namely to the feature DEP on little *v*. This, in turn, is a violation of well motivated locality conditions on allomorphy, according to which the conditioning environment must be in the same complex head (Bobaljik, 2012), and/or adjacent to the terminal node subject to allomorphy (Embick, 2010; Arregi & Nevins, 2012). Neither of the two conditions is met in (72): the agreement prefix is in T, a different complex head than the one hosting DEP, and even after phonological concatenation, T and *v* are not adjacent (at the very least, the lexical root intervenes).

(72) Subject agreement in clausal subjunctives

... ukuthi a-phek-e  
 COMP 1s-cook-FS.SBJV  
 ‘... so that he cook’

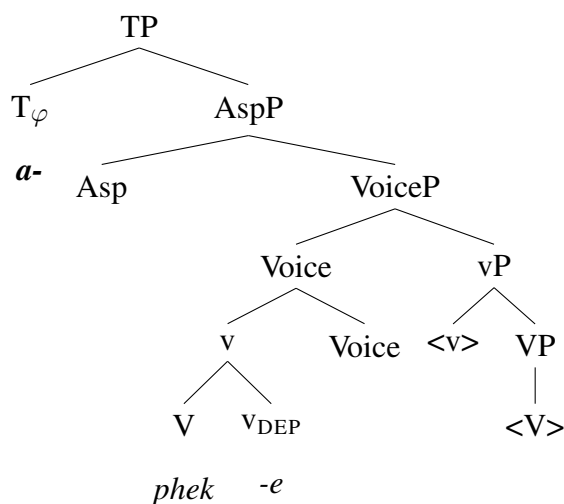

Note that, assuming post-syntactic lowering of prefixal heads onto the complex head in Voice



does not satisfy the adjacency condition.

The latter problem arises also in small subjunctives. I argued above that the  $\varphi$  probe in small subjunctives is on the highest head, namely on Voice. Since Voice is a suffix, and the agreement marker is a prefix, I propose that  $\varphi$  is fissioned from the root terminal of the Voice complex head, as shown in (73).

(73) Subject agreement in small subjunctives (Voice complex head)

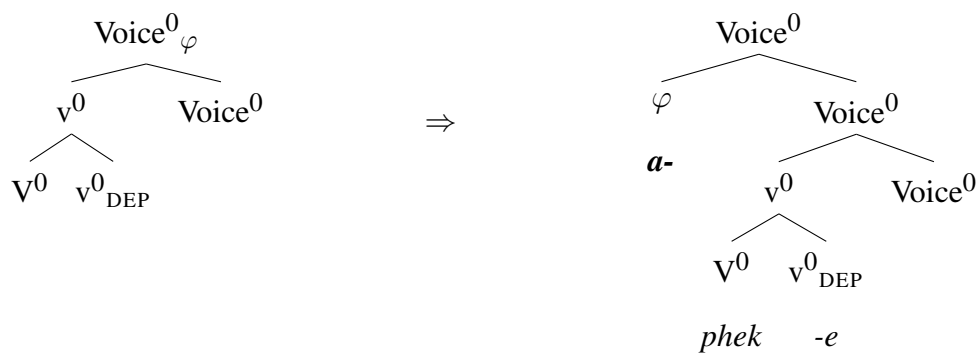

Assuming that prefixation corresponds to left-adjunction, as I do in (73), the  $\varphi$  node is not adjacent to little  $v$ , which contains the conditioning feature DEP.

It is possible that such cases of allomorphy can be better handled by other theories of allomorphy, which allow less strict locality conditions. For instance, according to the Span Adjacency Hypothesis proposed by Merchant (2015), allomorphy conditioned by adjacent *spans* – sequences of heads which form an extended projection. In (73), for instance,  $v$ , Voice and Neg do form a span as they are a proper subsequence of the verbal extended projection. Nonetheless, the span conditioning allomorphy in  $\varphi$ , namely  $\langle \text{Voice}, v \rangle$ , is not adjacent to  $\varphi$  due to its prefixal nature.

It is worth noting that the allomorphy of the subjunctive agreement prefix is not the only instance of non-local conditioning. The final suffix shows allomorphy in the same kind of environment. In non-negated infinitives, for instance, the final suffix is *-a*. In negative counterparts, it



argued that the so called moods in Ndebele, principal, participial and subjunctive moods, should be seen as this type of morphology. Defining these forms as specific to particular syntactic configurations allows us to avoid stipulations about their distribution, which is very systematic. The Positional Licensing Hypothesis also accounts for the fact that categories and metacategories cross-cut each other in verbal paradigms and that metacategories are irrelevant in determining synthesis and periphrasis.

In section 6.3, I demonstrated the inconsistent association of  $\varphi$ -agreement probes with functional heads in the Ndebele clause. I proposed the Agreement-V-Chain generalization according to which the number and exact position of  $\varphi$ -probes in the syntax is determined derivationally, and depends on the number and size of V-chains formed by the mechanism of V-selection. In particular a  $\varphi$ -probe is located on the highest head of each V-Chain. As such, this generalization accounts for the variability in the location of the  $\varphi$ -probes and provides a theoretical frame for the pre-theoretical generalization that the number of  $\varphi$ -probes in a complex verbal expression correlates with the number of verbs in the expression.

## CHAPTER 7

### CONCLUSION

In this thesis, I developed a theory of multi-verbal syntax which makes precise the ways in which a single clausal spine may contain more than one element of verbal category. Analyzing data from Ndebele, I identified three types of multi-verb constructions, which differ in the type of auxiliary/light verb involved. First, lexical light verbs are regular, projecting verbs selecting for a small clause-like constituent (typically a VoiceP). This type of multi-verb construction consists of two extended projections, even though one of them is reduced. The other two multi-verb constructions involve auxiliary verbs, i.e. non-projecting verbs. Aspectual auxiliaries are functional verbs – elements of the verbal category whose position in the extended projection is a higher functional level. As such, aspectual auxiliaries are necessarily part of another verb's extended projection. Finally, compound tenses are formed with the default auxiliary *be* – a verbal expletive selected by one of the inflectional heads in the main verb's extended projection. With this typology of multi-verb constructions I concluded that there are no verbs with obligatorily limited projection, as auxiliary verbs have to be treated under the VP approach. Rather, there are verbs which can always project a full clause (projecting verbs) and verbs which are by definition part of another verb's extended projection and never project independent functional structure (auxiliaries).

In the next section, I summarize the main theoretical questions I raised and the answers I offered. Section 7.2 is a synthesis of claims about the two syntactic dependencies, Infl-agreement and selection, and the role they play in the inflectional domain.

#### **7.1 Main questions and answers: a summary**

##### *7.1.1 Multi-verbal syntax and the Extended Projection Hypothesis*

One of the main questions I set out with concerns the ability of a single verbal extended projection to host more than one verbal element – a question about monoclausality of multi-verb construc-

tions. Assuming that functional heads in the clausal spine are projected from a verb (the Extended Projection Hypothesis), a question arises as to which verb they are projected from. In this respect, I considered three approaches to auxiliary verbs, the VP approach, the FP approach and the Insertion approach, each of which accommodates auxiliary verbs in a different way. According to the FP approach and the Insertion approach, the auxiliary is part of the main verb's extended projection (either because it's base generated as a functional head or inserted derivationally). According to those approaches, the entire clausal spine is projected from the main verb (1). The VP approach, on the other hand, assumes that the auxiliary projects, but only the VP. The functional structure above it is a resumed extended projection of the main verb (2). The third possibility I considered is that each verb in a multi-verb construction projects its own functional structure. As a result, the construction contains two separate extended projections (3).

- (1) FP/Insertion Approach    (2) VP Approach    (3) Light verb constr.

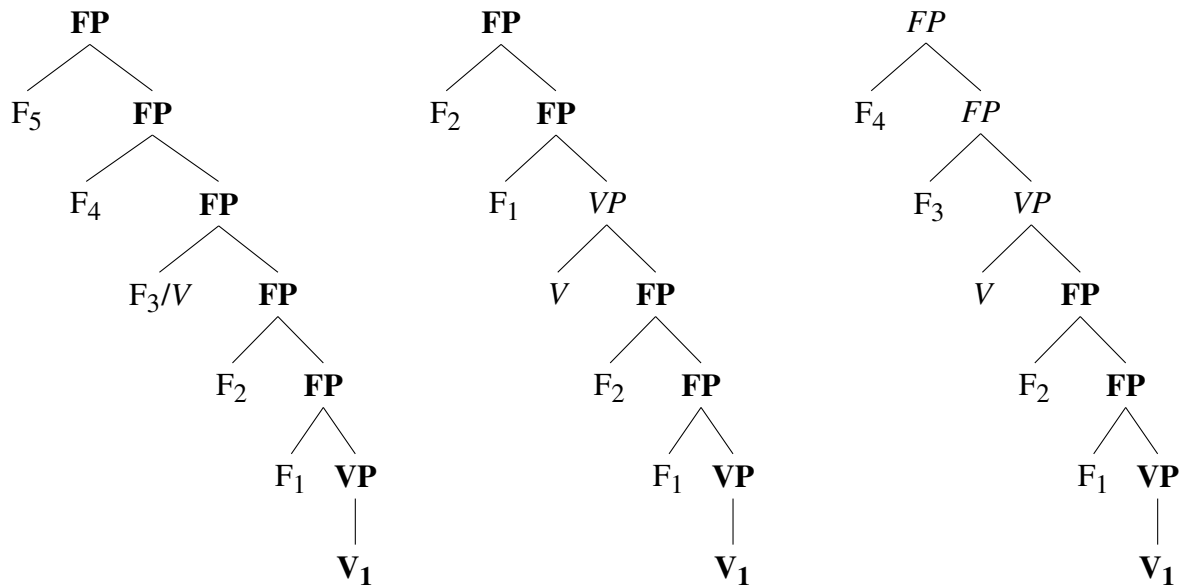

I argued that only two of the derivations are possible: the auxiliary-verb syntax in (1) and the light-verb syntax in (3). The hypothesis in (2), where an auxiliary is a verb projecting just a VP, finds no empirical support in Ndebele and is theoretically problematic. It assumes that auxiliaries

are of the same category as lexical verbs, and yet cannot project like lexical verbs (the limited-projection problem). I proposed a typology of verbs whose category features differ in a way that captures their projecting or non-projecting nature. In particular, projecting and non-projecting verbs differ in the level specification of category feature (4)-(6).

- |   |   |   |
|---|---|---|
| (4) Lexical verb:   | (5) Aspectual auxiliary:                                  | (6) Default auxiliary:                                    |
| $\left[ \text{CAT: } \langle \text{V}, 1 \rangle \right]$ | $\left[ \text{CAT: } \langle \text{V}, 3 \rangle \right]$ | $\left[ \text{CAT: } \langle \text{V}, 0 \rangle \right]$ |

Lexical verbs are of category  $\langle \text{V}, 1 \rangle$ , which means that they are the first element in the extended projection. This is what makes them *projecting verbs*. Auxiliaries, on the other hand, have level value other than 1. Functional verbs (aspectual auxiliaries in Ndebele) are verbs of a functional level, e.g.  $\langle \text{V}, 3 \rangle$ . Since level 3 in Ndebele is the position of Asp in the hierarchy,  $\langle \text{V}, 3 \rangle$  is the category of functional verbs with aspectual meanings, namely ‘still’ (*lokhe*) or ‘constantly’ (*hlezi*). The other type of non-projecting verb is the default auxiliary whose category is  $\langle \text{V}, 0 \rangle$ . The category level 0 prevents the default auxiliary from participating in HoP-Merge (the structure building operation forming Hierarchies of Projections), and it can only be merged as an expletive satisfying a selectional V-feature on an inflectional head.

The proposed typology of verbal elements provides a precise theoretical frame for the variety of multi-verb constructions, restricting the ways in which multi-verbal syntax can be monoclausal.

### 7.1.2 *The nature of auxiliary insertion*

Having rejected the VP approach, I considered the two non-projecting approaches, the FP and the Insertion approaches, in more detail. I argued that both are necessary to account for different types of auxiliaries. While the analysis of aspectual auxiliaries as functional verbs falls out straightforwardly from the proposed category of functional verbs and HoP-Merge, default periphrasis

requires more attention, as we need to understand the insertion process and its trigger(s). I followed the widely shared intuition that default periphrasis has a profile of a last resort mechanism which repairs a failure caused by a disproportion between the amount of inflection and the number of inflection hosts, that is verbs. This approach produces two basic questions about default periphrasis:

**The Failure Question:** What specific aspects of the grammar determine when an inflection fails to combine with the main verb (to form a synthetic expression)?

**The Repair Question:** Why is this failure repaired by inserting an auxiliary verb?

I argued for a specific type of answer to each question. With respect to the Failure Questions, I pointed out the importance of the robust generalization that default periphrasis correlates with increased inflectional complexity. For instance, many languages express past tense synthetically on the verb, but to express both past tense and perfect aspect, a default auxiliary is necessary. This observation is not new and has been made explicit in accounts of periphrasis, but attempts to derive it are scarce (see e.g. Kiparsky (2005)). Bjorkman's (2011) detailed account of default periphrasis crosslinguistically specifically identifies inflectional overflow as the source periphrasis, but the actual mechanism of auxiliary insertion makes no clear prediction that increased inflectional complexity correlates with periphrasis. This is because, ultimately, auxiliary insertion relies on the lack of verb movement, whose distribution is not related to inflectional complexity in a principled way. I argued that head-movement should not be treated as the regulator of default periphrasis and that instead, its triggers must be related to inflectional complexity only. The implementation I proposed was an adaptation of Cowper's (2010) activity condition on c-selection, whereby a marked inflectional head cannot establish a checking relation with the main verb if the verb has no unvalued Infl-feature.

My answer to the Repair Question is based on the objective to *derive* auxiliary insertion as the repair strategy. I proposed the mechanism of Cyclic Selection, in which heads attempt to check

their selectional features against an accessible goal in the structure already built. Thus, inflectional heads check their V-features against the main verb until the main verb becomes inactive, in which case any unchecked selectional feature that remains triggers merge of a verbal expletive as its specifier. This view of auxiliary insertion requires defining a verbal expletive, which I do analogously to nominal expletives. However, it requires neither introducing a rule of auxiliary insertion to the grammar, nor defining *stranded inflection* to constitute the structural description of such an insertion rule.

### 7.1.3 *Morphological selection in multi-verb constructions*

The third major question I addressed concerns the morphological form of the main verb in multi-verb constructions and the source of this morphology. I argued that the role of c-selection is limited. Only lexical light verbs determine the category of their complement via c-selection and they are the only contexts in which some selectional idiosyncrasy is observed. Compound tenses and aspectual auxiliary constructions are structured with a single extended projection, with the auxiliary verb associated with one of its functional heads. Consequently, the size and category of auxiliaries' complements are entirely predictable from clause structure. Indeed, no selectional idiosyncrasies can be found in multi-verb constructions with non-projecting verbs.

Furthermore, verbal morphology includes categories such as past tense, imperfective aspect, perfect aspect etc. These, I argued, are determined by Infl-agreement. An important argument for this claim comes from aspectual-auxiliary constructions, in which main verb morphology is predictable from the position of a given aspectual auxiliary in the clause.

(7) [TP [TP<sub>Perf</sub> *aux* [AspP<sub>(IMPF)</sub> (*aux*) [VP V ]]]]

Auxiliaries located lower (in Asp) allow less inflectional variability in their complement than the auxiliary associated with a higher head (TP<sub>Perf</sub>). This is because the main verb's Infl-feature can



be valued by either Asp or  $T_{\text{Perf}}$  in the latter case, but in the former case locality of agreement prevents covariation with the higher  $T_{\text{Perf}}$ .

Finally, I proposed that morphological forms such as subjunctive, principal and participial forms do not correspond to morphosyntactic features (e.g. Infl:PTCP or Mood:SBJV). I put forth a hypothesis that their licensing is purely configurational. That is, subjunctive, principal and participial forms are defined by the syntactic positions in which they appear. I argued that the so called principal mood is the form of the highest verb in an indicative clause. Subjunctive morphology is licensed in inflectionally deficient syntactic context; in particular, in the immediate environment of an unvalued Infl-feature. In light verb constructions this environment is present due to the lexical light verb's Infl-feature, while in subjunctive clauses, the context is provided by the subjunctive T, whose temporal deficiency is morphosyntactically encoded by an unvalued, rather than a valued Infl-feature. Finally, I treated participial morphology as the elsewhere verbal form.

## **7.2 Final thoughts of inflectional dependencies: Infl-agreement and V-selection**

I proposed that various aspects of multi-verb syntax are regulated by two inflectional dependencies: Infl-agreement and selection. Each mechanism plays a specific role in determining periphrasis and complement size and morphology. Below, I discuss both Infl-agreement and selection, reiterating their contribution and pointing out advantages over alternative ways of modeling inflectional dependencies.

### *7.2.1 Infl-agreement*

The discussion of synthesis and periphrasis is heavily reliant on the assumption that inflections and verbs combine. One way in which accounts of periphrasis differ is in the way they understand the term "combine". Infl-agreement in my account is a way in which inflections combine with verbs,

or how verbs become inflected, a view advocated by Adger (2003); Pesetsky & Torrego (2007); Cowper (2010); Bjorkman (2011); Wurmbrand (2011), among others. In this view, a past tense verb form is the result of agreement between the verb and a T with Infl:PST, while imperfective morphology is the result of the verb agreeing with a head bearing Infl:IMPF. There are, however, alternative accounts of this type of inflectional dependency. Based on the discussion of Ndebele in previous chapters, I present below the advantages of Infl-agreement (8-a) over the following alternatives: selection (8-b), head movement/lowering (8-c), and feature transmission (8-d).

(8) Alternative ways of implementing V–Infl synthesis

- a. Infl-agreement:  $[\text{FP Infl:IMPF} \quad \text{[Verb Infl: } \underline{\text{impf}} \text{ ]}]$
- b. Selection:  $[\text{FP Sel:IMPF} \quad \text{[ Verb Cat:IMPF ]}]$
- c. Head movement:  $[\text{FP F}_{\text{IMPF}} \quad \text{[ Verb V ]}] \Rightarrow [\text{FP V+F}_{\text{IMPF}} \quad \text{[Verb <V> ]}]$
- d. Feature transmission:  $[\text{FP F}_{\text{IMPF}} \quad \text{[ Verb V ]}] \Rightarrow [\text{FP F} \quad \text{[Verb V}_{\text{IMPF}} ]]$

One argument against selection (8-b) was summarized in the previous section: I argued in chapter 3 that a selection based analysis of aspectual-auxiliary constructions fails to derive the flexibility of auxiliary *se* ‘already’ to combine with perfect or imperfective participles and the lack of such flexibility with *lokhe* and *hlezi* – auxiliaries associated with the lower Asp head. In a selection-based account, this pattern must be stipulated as a selectional optionality of *se*, which the other two auxiliaries lack. As we’ve seen, an Infl-agreement account derives exactly this pattern.

Another way of defining the way in which verbs combine with inflection is by head movement. As schematized in (8-c), a verb becomes inflected (here, for imperfective aspect) by moving to a

head with the relevant inflectional feature. We have seen that head-movement and Infl-agreement are not mutually exclusive – in Bjorkman’s (2011) analysis, for instance, they cooccur and interact in triggering periphrasis. We have, however, also seen analyses of periphrasis based exclusively on head-movement (Arregi, 2000; Embick, 2000). Assuming that periphrasis is the failure of inflection to combine with a verb, the arguments against head-movement approaches to periphrasis presented in chapter 4 constitute arguments against viewing head-movement as the (only) relation combining verbs and inflections. Additionally, there is an empirical argument for the Infl-agreement approach to inflection, a case where head-movement cannot be at play, namely inflectional co-variation between two verbs. Recall that in lexical light verb constructions, the small subjunctive complement of the lexical LV co-varies with the LV’s tense feature (9).

- (9) Ngi-phinde: [VoiceP nga-pheka                    ]  
           1sg-again.PST                    1sg-cook.SBJV.PST  
           ‘I cooked again’

I treated the past tense inflection on both verbs in (9) as the result of Infl-agreement: the main verb agrees with the light verb (dependent valuation), and the light verb agrees with T. While past tense inflection on the light verb could be argued to result from movement of the LV to T, the past tense form of the main verb cannot be derived in this way – the small subjunctive complement is a VoiceP and so there is no T for the verb to move to. A lowering analysis (T-to-V lowering or affix hopping) faces exactly the same problem. Given only one T in the structure of (9), there is no T or tense affix to lower onto the main verb. I conclude, then, that the tense covariation in (9) must be seen as an agreement phenomenon.<sup>1</sup>

It is worth noting that (9) is also challenging for the selection view. A selection-based analysis of facts like these would be very inefficient as it would have to stipulate as selectional features the systematic tense covariation patterns, together with the blocking effects in tense agreement

---

1. Evidence for Infl-agreement from co-variation between verbs in verb clusters can also be found in Wiklund (2005, 2007); Wurmbrand (2011).

discussed in chapter 6.

The mechanism of feature transmission (8-d) was proposed by Arregi & Klecha (2015) as a process combining verbs with inflections in English. Like Infl-agreement, feature transmission passes inflectional features from higher heads to lower ones. It differs from agreement in one crucial way: the relevant feature is *moved* from one head to another, not *shared* by the two heads, as shown in (8-d). In this respect, feature transmission resembles the movement/lowering approach: it is only suitable for cases of inflection which do not involve morphological covariation. That is, feature transmission cannot be responsible for the covariation in (9) as it predicts the past tense feature to be realized in only one position (on one of the verbs), but not in both.

In sum, inflectional covariation between verbs in multi-verb constructions is a phenomenon which is best accounted for by an agreement relation, providing independent motivation for Infl-agreement as one of the grammatical dependencies relating inflectional heads and verbs.

The next sections focus on selection, the other inflectional dependency regulating the syntax of the verbal domain. I focus on V-selection – the checking of selectional V-features involved in default periphrasis.

### 7.2.2 *V-selection*

Selection was argued to play a limited role in determining the size, category and morphology of the main verb complement in multi-verb constructions. This is because these properties of the main verb are to a large extent predictable from other aspects of the syntax of multi-verb constructions, such as clause structure and the locality of agreement. The only cases where the complement is determined selectionally is with lexical light verbs, which idiosyncratically combine with a VoiceP, NegP or a DP.

A different, and an important, role of selection in the proposed theory is in default periphrasis: the immediate trigger of auxiliary insertion is an unchecked selectional V-feature on an inflectional head. I proposed that V-checking is a relation between verbs and inflectional heads which underlies

both synthesis and periphrasis. Synthesis is the result of V-checking by the main verb, while periphrasis arises in cases when checking by the main verb is unavailable, resulting in merging a verbal expletive – the default auxiliary.

The view of auxiliary insertion as selection-triggered merge has advantages over alternative approaches in which auxiliary insertion is implemented as a special rule of insertion, as it *derives* auxiliary insertion as the repair strategy from independent properties of morphosyntactic features. If the stranded inflection is a selectional feature, selection-triggered merge is what we expect the repair strategy to be. As such, it allows us to understand the relationship between an inflectional head and the auxiliary verb as a relation that otherwise holds between verbs and inflectional heads.

In addition to this, V-checking may be of relevance to other aspects of verbal syntax. For instance, I suggested in chapter 4 that V-checking is the relation which underlies head movement of the verb, even though it does not require it. In the configurations in (10), the verb establishes a checking relation with F, which means that F and V form a synthetic expression. Whether V-to-F movement takes place depends of the selectional feature in F: it may be lexically specified for requiring movement of the checking controller (indicated by an asterisk in (10-a)) or not, giving rise to a synthetic expression without head movement (10-b).

- (10) a.  $\left[ F_{\text{SEL:V}^*} \left[ V_{\text{CAT:V}} \right] \right]$  V-checking and V-to-F movement
- b.  $\left[ F_{\text{SEL:V}} \left[ V_{\text{CAT:V}} \right] \right]$  V-checking without V-to-F movement

In other words, a V-checking relation does not guarantee verb movement, but it is a precondition for it. This correctly predicts that in default periphrasis the main verb does not undergo head movement to the head which triggers merge of the auxiliary verb. This scenario is schematized in (11), where V' is the auxiliary verb selected by T. Since in periphrasis, it is the auxiliary verb, not the main verb, that checks the selectional V-feature on T, the main verb is not in a checking relation with T and hence cannot head-move to T.

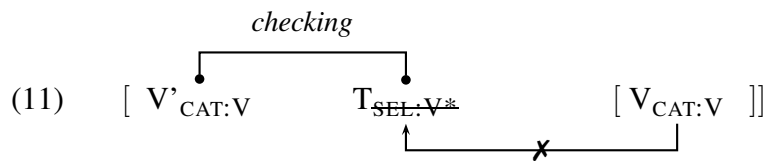

Assuming that all functional heads in the verbal extended projection have a V-feature, the verb can establish a checking relation with multiple heads. In chapter 6, I referred to the sequence of heads in a V-checking relation as a *V-Chain*. An example V-Chain is shown in (12).

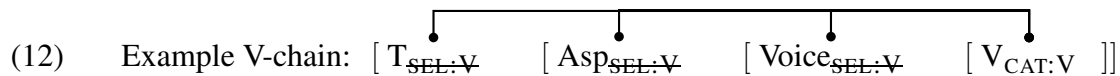

Whether the verb moves in (12), and how high, depends of the nature of the selectional features in the chain (as requiring movement or not). But given the hypothesis that head-movement of the verb is parasitic on a V-checking relation, we can identify the V-chain as the syntactic object delimiting the domain of head movement.

Another phenomenon where V-Chains potentially play a role is in the distribution of  $\varphi$ -agreement probes in the inflectional domain. In chapter 6, I discussed the apparently inconsistent association of  $\varphi$ -probes with functional heads and argued that their distribution can be predicted from the number and size of V-Chains in the structure. This generalization captures the apparent distributional inconsistencies of  $\varphi$ -probes caused by the overflow pattern of default periphrasis, and in multi-verb constructions with aspectual auxiliaries and lexical light verb constructions. In all cases, a  $\varphi$ -probe is located on the highest head of each V-Chain. Thus, V-Chains can be characterized as constituting the domain of  $\varphi$ -agreement and head movement of the verb.

Finally, let me point out that recognizing V-Chains as syntactic objects supplies the theory with a notion potentially useful in the analysis of verbal morphosyntax in languages in which some inflectional categories are not related with the verb by head movement or lowering, as has been proposed to be the case in Bantu languages. If prefixal verbal morphology (e.g. the tense prefix) in Bantu is indeed not combined with the verbal (complex) head in syntax, V-chains provide a way of understanding such morphology as "verbal" and distinguish it from those elements in the clause

whose morphosyntactic relation to the verb is less tight.

## REFERENCES

- Abney, S. P. (1987). *The English noun phrase in its sentential aspect*. PhD thesis, Massachusetts Institute of Technology.
- Abusch, D. (1997). Sequence of tense and temporal de re. *Linguistics and Philosophy*, 20(1-50).
- Adams, N. (2010). *The Zulu Ditransitive Verb Phrase*. PhD thesis, University of Chicago.
- Adger, D. (2003). *Core syntax: A minimalist approach*. Oxford University Press.
- Adger, D. (2010). A minimalist theory of feature structure. In *Features: Perspectives on a key notion in linguistics*. Oxford University Press.
- Adger, D. & Svenonius, P. (2011). Features in minimalist syntax. *The Oxford handbook of linguistic minimalism*, (pp. 27–51).
- Aelbrecht, L. & Harwood, W. (2015). To be or not to be elided: VP ellipsis revisited. *Lingua*, 153, 66–97.
- Akmajian, A., Steele, S. M., & Wasow, T. (1979). The category AUX in universal grammar. *Linguistic Inquiry*, 10(1), 1–64.
- Akmajian, A. & Wasow, T. (1975). The constituent structure of VP and AUX and the position of the verb be. *Linguistic Analysis*, 1, 205–245.
- Alboiu, G. & Avery, P. (2009). Argument-Adjunct Asymmetries in Ndebele: The long and the short of it. *Bucharest Working Papers in Linguistics*.
- Arregi, K. (2000). Tense in Basque. *Ms., MIT*. Available at <http://uiuc.edu/~karlos>.
- Arregi, K. & Klecha, P. (2015). The morphosemantics of past tense. In *Proceedings of the 45th conference of the North East Linguistics Society*.
- Arregi, K. & Nevins, A. (2012). *Morphotactics. Basque Auxiliaries and the Structure of Spellout*. Springer.
- Bach, E. (1967). Have and be in English syntax. *Language*, (pp. 462–485).
- Baker, M. (2003). Agreement, dislocation, and partial configurationality. In *Formal approaches to function in grammar* (pp. 107–132). John Benjamins.
- Baker, M. (2008). *The Syntax of Agreement and Concord*. Cambridge University Press.
- Baker, M. & Willie, W. U. (2010). Agreement in Ibibio: From every head to every head. *Syntax*, 13(2), 99–132.
- Barrett-Keach, C. N. (1980). *The syntax and interpretation of the relative clause construction in Swahili*. New York: Garland Press.



- Barrett-Keach, C. N. (1986). Word-internal evidence from Swahili for AUX/INFL. *Linguistic Inquiry*, (pp. 559–564).
- Béjar, S. & Rezac, M. (2009). Cyclic Agree. *Linguistic Inquiry*, 40(1), 35–73.
- Benmamoun, E. (2000). *The feature structure of functional categories: A comparative study of Arabic dialects*, volume 16. Oxford University Press.
- Bjorkman, B. & Zeijlstra, H. (2014). Upward Agree is superior. Ms.
- Bjorkman, B. A. M. (2011). *BE-ing default: The morphosyntax of auxiliaries*. PhD thesis, MIT.
- Bliss, H. & Storoshenko, D. R. (2009). Grammaticization of topic in Shona. Paper presented at the 3rd International Conference on Bantu Linguistics (BANTU 3), Tervuren, Belgium, March 24-28.
- Bobaljik, J. (1994). What does adjacency do? *Massachusetts Institute of Technology working papers in linguistics*, 22(1).
- Bobaljik, J. D. (2012). *Universals in comparative morphology*. Cambridge, MA: MIT Press.
- Borsley, R. & Rivero, M.-L. (1994). Clitic auxiliaries and incorporation in Polish. *Natural Language and Linguistic Theory*, 12, 373–422.
- Botne, R. & Kershner, T. (2000). Time, tense and the perfect in Zulu. *Afrika und Übersee*, 83, 161–180.
- Bošković, v. (2014). Now I'm a phase, now I'm not a phase: On the variability of phases with extraction and ellipsis. *Linguistic Inquiry*, 45(1), 27–89.
- Bresnan, J. (1995). Category Mismatches. In A. Akinlabi (Ed.), *Theoretical Approaches to African Linguistics* (pp. 19–46). Trenton, New Jersey: Africa World Press.
- Bresnan, J. & Mchombo, S. (1995). Lexical Integrity Principle: Evidence from Bantu. *Natural Language and Linguistic Theory*, 13, 181–254.
- Bresnan, J. & Mchombo, S. A. (1987). Topic, pronoun, and agreement in Chichewa. *Language*, (pp. 741–782).
- Buell, L. C. (2005). *Issues in Zulu Verbal Morphosyntax*. PhD thesis, University of California Los Angeles.
- Buell, L. C. (2006). The Zulu conjoint/disjoint verb alternation: focus or constituency? *ZAS Papers in Linguistics*, 43, 9–30.
- Buell, L. C. & de Dreu, M. (2013). Subject raising in Zulu and the nature of PredP. *The Linguistic Review*, 30(3), 423–466.

- Burkholder, R. (2014). The Syntactic Structure of Negation in Ndebele. *Ms. University of Chicago*.
- Bybee, J., Perkins, R., & Pagliuca, W. (1994). *The Evolution of Grammar: Tense, Aspect and Modality in the Languages of the World*. Chicago, London: University of Chicago Press.
- Bybee, J. L. & Dahl, O. (1989). The Creation of Tense and Aspect Systems in the Languages of the World. *Studies in Language*, 13, 51–103.
- Carstens, V. (1991). *The morphology and syntax of determiner phrases in Kiswahili*. PhD thesis, University of California Los Angeles.
- Carstens, V. (2005). Agree and EPP in Bantu. *Natural Language and Linguistic Theory*, 23(2), 219–279.
- Carstens, V. & Kinyalolo, K. (1989). On IP structure: Tense, aspect, and agreement. *Ms., Cornell University*.
- Carstens, V. & Mletshe, L. (2015). Negative concord and nominal licensing in Xhosa and Zulu. *Natural Language and Linguistic Theory*.
- Cheng, L. & Downing, L. J. (2012). Against FocusP: Arguments from Zulu. *Contrasts and positions in Information Structure*.
- Chomsky, N. (1957). *Syntactic Structures*. The Hague/Paris: Mouton.
- Chomsky, N. (1980). On binding. *Linguistic Inquiry*, 11(1), 1–46.
- Chomsky, N. (1993). A minimalist program for linguistic theory. In K. Hale & S. J. Keyser (Eds.), *The View from Building 20: Essays in Linguistics in Honor of Sylvain Bromberger* (pp. 1–52). MIT Press.
- Chomsky, N. (2000). Minimalist inquiries: The framework. In R. Martin, D. Michaels, & J. Uriagereka (Eds.), *Step by step: Essays on minimalist syntax in honor of Howard Lasnik* (pp. 89–155). Cambridge, MA: MIT Press.
- Chomsky, N. (2001). Derivation by phase. In M. Kenstowicz (Ed.), *Ken Hale: A life in language* (pp. 1–52). Cambridge, MA: MIT Press.
- Cinque, G. (1998). ‘Restructuring’ and the order of aspectual and root modal heads. *University of Venice, Working Papers in Linguistics*, 8, 113–140.
- Cinque, G. (1999). *Oxford Studies in Comparative Syntax*, chapter Adverbs and functional heads: A cross-linguistic perspective. Oxford University Press.
- Cinque, G. (2001). “Restructuring” and functional structure. *University of Venice working papers in linguistics*, 11, 45–127.
- Comrie, B. (1986). Tense in indirect speech. *Folia linguistica*, 2(3-4), 256–296.

- Cook, T. (2013). The status of the macrostem in reduplication in Ndebele and Zulu. *Proceedings of the Annual Meeting of the Berkeley Linguistics Society*, 37.
- Costantini, F. (2007). On tense mismatch and a morphosyntactic theory of Sequence of Tenses. *Rivista di Grammatica Generativa*, 32(39–64).
- Cowper, E. (2005). The geometry of interpretable features: Infl in English and Spanish. *Language*, 81(1), 10–46.
- Cowper, E. (2010). Where auxiliary verbs come from. In *Proceedings of the 2010 annual conference of the Canadian Linguistic Association*.
- Dahl, O. (1985). *Tense and Aspect Systems*. Oxford, New York: Blackwell.
- de Dreu, M. (2008). The internal structure of the Zulu DP. Master's thesis, Universiteit Leiden.
- Déchaine, R.-M. (1993). *Predicates across categories: Towards a category-neutral syntax*. PhD thesis, University of Massachusetts, Amherst.
- Déchaine, R.-M. (1995). One *be*. *Linguistics in the Netherlands*, 12(1), 73–88.
- Demuth, K. & Gruber, J. (1995). Constraining XP sequences. *Niger-Congo Syntax and Semantics*, 6, 3–30.
- Demuth, K. & Harford, C. (1999). Verb raising and subject inversion in Bantu relatives. *Journal of African Languages and Linguistics*, 20, 41–62.
- Diercks, M. (2010). *Agreement with subjects in Lubukusu*. PhD thesis, Georgetown University.
- Doke, C. M. (1950). *Textbook of Zulu Grammar*. Cape Town: Longmans, Green & Co. Ltd.
- Downing, L. J. (1990). Local and Metrical Tone shift in Nguni. *Studies in African Linguistics*, 21, 261–317.
- Eid, M. (1983). The copula function of pronouns. *Lingua*, 59, 197–207.
- Embick, D. (2000). Features, Syntax, and Categories in the Latin Perfect. *Linguistic Inquiry*, 31(2), 185–230.
- Embick, D. (2004). On the structure of resultative participles in English. *Linguistic Inquiry*, 35, 355–392.
- Embick, D. (2010). *Localism versus globalism in morphology and phonology*, volume 60. MIT Press.
- Embick, D. & Noyer, R. (2001). Movement operations after syntax. *Linguistic Inquiry*, 32(4), 555–595.
- Emonds, J. E. (1978). The verbal complex V'-V in French. *Linguistic Inquiry*, 21, 49–77.

- Enç, M. (1987). Anchoring conditions for tense. *Linguistic Inquiry*, 18, 633–657.
- Fu, J., Roeper, T., & Borer., H. (2001). The VP within process nominals: evidence from adverbs and the VP anaphor *do so*. *Natural Language and Linguistic Theory*, 19, 549–582.
- Giannakidou, A. (2009). The dependency of the subjunctive revisited: temporal semantics and polarity. *Lingua*, 119(1883–1908).
- Giorgi, A. (2009). Toward a syntax of the subjunctive mood. *Lingua*, 119(12), 1837–1858.
- Giorgi, A. & Pianesi, F. (1997). *Tense and Aspect: From Semantics to Morphosyntax*. Oxford University Press.
- Giusti, G. (1997). The categorial status of determiners. In L. Haegeman (Ed.), *The New Comparative Syntax* (pp. 95–124). London: Longman.
- Goldberg, L. M. (2005). *Verb-stranding VP ellipsis: A cross-linguistic study*. PhD thesis, McGill University Montréal, Québec, Canada.
- Grano, T. (2012). *Control and restructuring at the syntax-semantics interface*. PhD thesis, University of Chicago.
- Grimshaw, J. (1991). Extended projections. Brandeis University, Ms.
- Grimshaw, J. (2000). Locality and extended projection. *Amsterdam Studies in the Theory and History of Linguistic Science Series*, 4, 115–134.
- Hall, L. (2005). The *be* relative tenses of Zulu. *MA thesis, University of Pretoria*.
- Halpert, C. (2012). *Argument Licensing and Agreement in Zulu*. PhD thesis, MIT.
- Harley, H. & Ritter, E. (2002). Person and number in pronouns: A feature-geometric analysis. *Language*, (pp. 482–526).
- Harwood, W. (2013). *Being progressive is just a phase: dividing the functional hierarchy*. PhD thesis, Ghent University.
- Harwood, W. (2014a). Being progressive is just a phase: celebrating the uniqueness of progressive aspect under a phase-based analysis. *Natural Language and Linguistic Theory*, 33, 523–573.
- Harwood, W. (2014b). Rise of the Auxiliaries: a case for auxiliary raising vs. affix lowering. *The Linguistic Review*, 31(2), 295–362.
- Haspelmath, M. (2000). Periphrasis. In G. Booij, C. Lehmann, & J. Mugdan (Eds.), *Morphology: A Handbook on Inflection and Word Formation*, volume 1 chapter 68, (pp. 654–664). Berlin: de Gruyter.
- Henderson, B. (2006). Multiple agreement and inversion in Bantu. *Syntax*, 9(3), 275–289.

- Hoffman, R. (1966). Past tense replacement and the modal system. In A. Oettinger (Ed.), *Mathematical linguistics and automatic translation*. Cambridge, MA: Harvard University, Harvard Computation Laboratory.
- Holmberg, A. (2000). Deriving OV order in Finnish. In P. Svenonius (Ed.), *The Derivation of VO and OV* (pp. 123–152). Amsterdam: John Benjamins.
- Huddleston, R. (1974). Further remarks on the analysis of auxiliaries as main verbs. *Foundations of language* 11:215–229., 11, 215–229.
- Hyman, L. M., Inkelas, S., & Sibanda, G. (1999). Morphosyntactic correspondence in Bantu reduplication. In K. Hanson & S. Inkelas (Eds.), *The Nature of the Word: Essays in Honor of Paul Kiparsky* (pp. 173–310). Amsterdam: John Benjamins.
- Iatridou, S., Anagnostopoulou, E., & Izvorski, R. (2003). Observations about the form and meaning of the Perfect. In A. Alexiadou, M. Rathert, & A. von Stechov (Eds.), *Perfect Explorations* (pp. 153–204). Mouton de Gruyter.
- Johnson, K. (2001). What VP ellipsis can do, and what it can't, but not why. In M. Baltin & C. Collins (Eds.), *The handbook of contemporary syntactic theory* (pp. 439–479). Oxford: Blackwell Publishers.
- Julien, M. (2001). The syntax of complex tenses. *The Linguistic Review*, 18, 125–167.
- Julien, M. (2002). *Syntactic Heads and Word Formation*. Oxford University Press.
- Katamba, F. (2003). Bantu nominal morphology. In D. Nurse & G. Philippson (Eds.), *The Bantu Languages*. Routledge.
- Kayne, R. (1994). *The antisymmetry of syntax*. MIT Press.
- Khumalo, J. S. M. (1981). *Zulu tonology*. PhD thesis, University of the Witwatersrand, Johannesburg.
- Khumalo, L. (2007). *An analysis of the Ndebele passive construction*. PhD thesis, University of Oslo.
- Kinyalolo, K. (1991). *Syntactic Dependencies and the Spec-Head Agreement Hypothesis in Ki-Lega*. PhD thesis, UCLA.
- Kiparsky, P. (2005). Blocking and periphrasis in inflectional paradigms. *Yearbook of Morphology 2004*, (pp. 113–135).
- Klein, W. (1992). The present perfect puzzle. *Language*, (pp. 525–552).
- Klein, W. (1994). *Time in language*. London: Routledge.
- Landau, I. (2004). The scale of finiteness and the calculus of control. *Natural Language and Linguistic Theory*, 22(4), 811–877.

- Letsholo, R. M. (2002). *Syntactic domains in Ikalanga*. PhD thesis, University of Michigan.
- Matushansky, O. (2006). Head movement in linguistic theory. *Linguistic Inquiry*, 37(1), 69–109.
- Mawadza, A. M. (2009). *A Basic Ndebele Grammar*. Dunwoody Press.
- McCawley, J. (1971). Tense and time reference in English. In C. Fillmore & D. T. Langendoen (Eds.), *Studies in linguistic semantics* (pp. 96–113). New York: Holt, Rinehart and Winston.
- McCawley, J. (1988). *The syntactic phenomena of English*. Chicago: University of Chicago Press.
- Merchant, J. (2001). *The syntax of silence: Sluicing, islands, and the theory of ellipsis*. Oxford University Press.
- Merchant, J. (2011). Aleut case matters. In E. Yuasa, T. Bagchi, & K. Beals (Eds.), *Pragmatics and autolexical grammar: in honor of Jerry Sadock*, number 176 in *Linguistic Today* (pp. 193–210). John Benjamins.
- Merchant, J. (2013). Polarity items under ellipsis. In L. L.-S. Cheng & N. Corver (Eds.), *Diagnosing Syntax* (pp. 441–462). Oxford University Press Oxford.
- Merchant, J. (2015). How Much Context is Enough? Two Cases of Span-Conditioned Stem Allomorphy. *Linguistic Inquiry*, 46(2), 273 – 303.
- Merchant, J. (2016). Roots don't select: A novel argument from category-dependent I-selection. Talk given at: *The 42nd meeting of the Berkeley Linguistics Society, University of California, Berkeley, 5 February 2016*.
- Migdalski, K. (2006). *The syntax of compound tenses in Slavic*. PhD thesis, LOT, Utrecht University.
- Muriungi, P. K. (2009). *Phrasal movement inside Bantu verbs: Deriving affix scope and order in Kiitharaka*. PhD thesis, Universitetet i Tromsø.
- Myers, S. P. (1987). *Tone and structure of the word in Shona*. PhD thesis, University of Massachusetts.
- Myers, S. P. (1998). AUX in Bantu Morphology and Phonology. In L. M. Hyman & C. W. Kisseberth (Eds.), *Theoretical Aspects of Bantu Tone*. CSLI Publications, Center for the Study of Language and Information.
- Ngonyani, D. (1996a). Vp Ellipsis in Ndendeule and Swahili Applicatives. In E. Garrett & F. Lee (Eds.), *Syntax at Sunset: UCLA Working Papers in Syntax and Semantics 1* (pp. 109–128). Los Angeles: UCLA.
- Ngonyani, D. (1998). V-to-i movement in kiswahili. In R. M. Beck, T. Geider, & W. Graebner (Eds.), *AAP Swahili Forum V*, volume 55 (pp. 129–144). Cologne: Institut für Afrikanistik, Universität zu Köln.

- Ngonyani, D. & Githinji, P. (2006). The asymmetric nature of Bantu applicative constructions. *Lingua*, 166, 31–63.
- Ngonyani, D. S. (1996b). *The morphosyntax of applicatives*. PhD thesis, University of California, Los Angeles.
- Nurse, D. (2008). *Tense and aspect in Bantu*. Oxford University Press.
- Ogihara, T. (1989). *Temporal reference in English and Japanese*. PhD thesis, University of Texas at Austin.
- Pancheva, R. (2003). The aspectual makeup of perfect participles and the interpretations of the perfect. In A. Alexiadou, M. Rathert, & A. von Stechov (Eds.), *Perfect Explorations* (pp. 277–306). Mouton de Gruyter.
- Pelling, J. N. (1966). *A practical Ndebele dictionary*. Daystar Publications Bulawayo.
- Pesetsky, D. (1991). Zero syntax, vol. 2: Infinitives. Ms.
- Pesetsky, D. & Torrego, E. (2007). The syntax of valuation and the interpretability of features. *Phrasal and clausal architecture: Syntactic derivation and interpretation*, (pp. 262–294).
- Picallo, C. (1984). The infl node and the null subject parameter. *Linguistic Inquiry*, 15(75–102).
- Pietraszko, A. (2017a). Auxiliary vs INFL in Bantu. The syntactic and phonological complexity of Ndebele verbs. *Natural Language and Linguistic Theory*, DOI: 10.1007/s11049-017-9373-0.
- Pietraszko, A. (2017b). Clause size and transparency in Ndebele. *Presentation given at the 91st Annual Meeting of the LSA, Jan 2017, Austin TX*.
- Pietraszko, A. (under review). Relative clauses and CP nominalization in Ndebele. Manuscript under review, University of Chicago (<http://lingbuzz.auf.net/lingbuzz/003273>).
- Pietraszko, J. A. (2016). The syntax of simple and compound tenses in Ndebele. *Proceedings of the Linguistics Society of America Annual Meeting*, 1(18), 1–15.
- Pollock, J.-Y. (1989). Verb movement, universal grammar, and the structure of IP. *Linguistic Inquiry*, (pp. 365–424).
- Posthumus, L. (2008). Naming the so-called continuous past tenses of the south-eastern Bantu languages with particular reference to Zulu. *South African Journal of African Languages*, 1.
- Preminger, O. (2011). *Agreement as a fallible operation*. Doctoral dissertation, MIT, Cambridge, MA.
- Preminger, O. (2014). *Agreement and its failures*. Number 68 in Linguistic Inquiry Monographs. Cambridge, MA: MIT Press.

- Preminger, O. & Polinsky, M. (2015). Agreement and semantic concord: a spurious unification. Manuscript: University of Maryland.
- Progovac, L. (1993). Non-augmented nps in kinande as negative polarity items. *Theoretical aspects of Bantu grammar*, 1, 257–270.
- Ramchand, G. & Svenonius, P. (2014). Deriving the functional hierarchy. *Language Sciences*, 46, 152–174.
- Roberts, I. (1998). Have/be raising, Move F, and procrastinate. *Linguistic Inquiry*, 29, 113–125.
- Ross, J. R. (1967). *Constraints on variables in syntax*. PhD thesis, Massachusetts Institute of Technology.
- Ross, J. R. (1969). Auxiliaries as main verbs. *Studies in Philosophical Linguistics 1:77–102.*, 1, 77–102.
- Rothstein, S. (1999). Fine-grained structure in the eventuality domain: The semantics of predicative adjective phrases and be. *Natural Language Semantics*, 7, 347–420.
- Rothstein, S. (2004). *Predicates and their subjects*. Springer.
- Rycroft, D. K. (1980). Ndebele and Zulu: some phonetic and tonal comparisons. *Zambezia*, 8, 109–128.
- Rycroft, D. K. (1983). Tone-patterns in Zimbabwean Ndebele. *Bulletin of the School of Oriental and African Studies*, 46(1), 77–135.
- Schütze, C. (2003). When is a verb not a verb? *Nordlyd*, 31, 400–415.
- Shlonsky, U. (2006). Extended projection and CP cartography. *Nouveaux cahiers de linguistique française*, 27, 87–93.
- Sibanda, G. (2004). *Verbal Phonology and Morphology of Ndebele*. PhD thesis, University of California, Berkeley.
- Sigurðsson, H. Á. (2015). The split T analysis. *Finiteness Matters*.
- Slattery, H. (1981). Auxiliary verbs in Zulu. *Occasional Papers, Department of African Languages. Rhodes University, Grahamstown, South Africa: Department of African Languages*.
- Steele, S., Akmajian, A., Demers, R., Jelinek, E., Kitagawa, C., Oehrle, R., & Wasow, T. (1981). *An encyclopedia of AUX: a study in cross-linguistic equivalence*, volume 5. Linguistic Inquiry Monographs Cambridge, MA.
- Stowell, T. (2007). Sequence of perfect. *Trends in Linguistics Studies and Monographs*.
- Svenonius, P. (1994). C-selection as feature checking. *Studia Linguistica*, 48(2), 133–155.



- Taraldsen, K. T. (2010). The nanosyntax of Nguni noun class prefixes and concords. *Lingua*, 120(6), 1522–1548.
- Tenny, C. L. (1987). *Grammaticalizing aspect and affectedness*. PhD thesis, Massachusetts Institute of Technology.
- Toews, C. (2009). The Expression of Tense and Aspect in Shona. In A. Ojo & L. Moshi (Eds.), *Selected Proceedings of the 39th Annual Conference on African Linguistics* (pp. 32–41). Somerville, MA: Cascadilla Proceedings Project.
- Travis, L. (1984). *Parameters and effects of word order variation*. Doctoral dissertation, MIT, Cambridge, MA.
- Van der Spuy, A. (1993). Dislocated noun phrases in Nguni. *Lingua*, 90(4), 335–355.
- Van der Wal, J. (2006). The disjoint verb form and an empty Immediate After Verb position in Makuwa. *ZAS Papers in Linguistics*, 43, 233–256.
- Visser, M. (2008). Definiteness and specificity in the isiXhosa determiner phrase. *South African Journal of African Languages*, 28(1), 11–29.
- von Staden, P. (1973). The initial vowel in Zulu. *African Studies*, 32(3), 163–181.
- von Stechow, A. (1995). On the proper treatment of tense. In *Proceedings of Semantics and Linguistic Theory*, volume 5 (pp. 362–386).
- Wiklund, A.-L. (2005). *The syntax of tenselessness: On copying constructions in Swedish*. PhD thesis, Umeå University.
- Wiklund, A.-L. (2007). *The syntax of tenselessness: Tense/mood/aspect-agreeing infinitivals*. Berlin: de Gruyter.
- Wurmbrand, S. (1998). *Infinitives*. PhD thesis, Massachusetts Institute of Technology.
- Wurmbrand, S. (2001). *Infinitives: Restructuring and clause structure*. Mouton de Gruyter.
- Wurmbrand, S. (2004). Two types of restructuring—Lexical vs. functional. *Lingua*, 114(8), 991–1014.
- Wurmbrand, S. (2011). The syntax of valuation in auxiliary-participle constructions. In *Proceedings of the 29th West Coast Conference on Formal Linguistics 29*.
- Zeijlstra, H. (2012). There is only one way to agree. *The Linguistic Review*, 29, 491–539.
- Zeller, J. (2012). Object marking in isiZulu. *Southern African Linguistics and Applied Language Studies*, 30(2), 219–235.
- Ziervogel, D. (1967). *A Handbook of the Zulu language*. Pretoria: J.L. van Schaik.