

The syntax of nominal phrases and the morphology of nominal compounds
in Mandarin (Chinese): A comparative study

by

Fulang Chen

A forum paper submitted in conformity with the requirements
for the degree of Master of Arts
Graduate Department of Linguistics
University of Toronto

August 2017

Supervisor: Prof. Diane Massam

Second reader: Prof. Elizabeth Cowper

Copyright © 2017 by Fulang Chen

Table of contents

Table of contents	I
Acknowledgments	IV
List of key figures	VI
Chapter 1 A single Spell-Out model of morpho-syntax	1
1.1 Aspects of the theories of syntax	5
1.2 Morphology as syntax	8
1.3 Mismatches between syntax and morphology: Evidence from Mandarin	11
1.4 A single Spell-Out model of morpho-syntax	14
1.5 A comparative study of Mandarin nominal phrases and nominal compounds	17
Chapter 2 The syntax of non-predicative <i>de</i>-constructions and the morphology of endocentric nominal compounds	19
2.1 Non-predicative <i>de</i> -constructions in Mandarin	19
2.1.1 <i>De</i> -constructions	19
2.1.2 Non-predicative <i>de</i> -constructions	22
2.1.3 Theta role and case	24
2.1.4 Noun ellipsis	26
2.1.5 Discussion	27
2.2 Endocentric nominal compounds in Mandarin	32
2.2.1 Endocentric nominal compounds in English	32
2.2.2 Compounding in Distributed Morphology	35
2.2.3 Right-headed A-N compounds	40
2.2.4 Right-headed N-N compounds	43

2.2.5	Left-headed N-X compounds	47
2.3	Interim summary	50
2.3.1	A note on Renumeration	50
2.3.2	A note on LF	52
2.3.3	A note on PF	53
2.3.4	Similarities between morphological and syntactic derivations	54
Chapter 3	The syntax of generic <i>de</i>-constructions and the morphology of synthetic nominal compounds	55
3.1	Generic <i>de</i> -constructions in Mandarin	55
3.1.1	Introduction	55
3.1.2	Compositionality	59
3.1.3	Discussion	61
3.2	Synthetic nominal compounds in Mandarin	64
3.2.1	Introduction	64
3.2.2	Recategorization	68
3.2.3	Fusion	72
3.2.4	Root allomorphy	77
3.2.5	The selection of the nP complement	78
3.3	Some cross-linguistic generalizations	79
3.3.1	“Phrasal compounds” in English	80
3.3.2	Synthetic nominal compounds in English	82
3.4	Interim summary	85
3.4.1	More on Renumeration	85

3.4.2	More on LF	86
3.4.3	More on PF	87
3.4.4	More on the similarities between morphological and syntactic derivations	88
Chapter 4	The syntax of other <i>de</i>-constructions and the morphology of other nominal compounds	89
4.1	Event structure in nominal phrases and nominal compounds	89
4.1.1	More on non-predicative <i>de</i> -constructions	89
4.1.2	Thematic non-predicative <i>de</i> -constructions and thematic generic <i>de</i> -constructions	92
4.1.3	Two types of event-structure nominal compounds	97
4.1.4	Right-headed V-N compounds	99
4.1.5	Thematic synthetic nominal compounds	102
4.2	Apposition, Root Merger, and exocentricity	104
4.2.1	Apposition in non-predicative <i>de</i> -constructions	104
4.2.2	Exocentric nominal compounds	105
4.2.3	Root Merger as a result of x° selection	110
Chapter 5	Remarks on the single Spell-Out model of morpho-syntax	111
5.1	Remarks on Renumeration	113
5.2	Remarks on LF	114
5.3	Remarks on PF	115
5.4	Remarks on the similarities between morphological and syntactic derivations	116
References		118

Acknowledgements

This forum paper is dedicated to my “roots”.

My love for nominal compounds was rooted in a research assistantship with Prof. Diane Massam on Niuean complex nominal compounds in the summer of 2015. I can still recall how fascinated I was by the idea of Distributed Morphology and ideas in *Compounding in Distributed Morphology* (Harley 2009). My love for Diane, however, was rooted in her Intro to Linguistics lectures that I took back in the fall of 2013. I must have fallen in love with her before falling in love with Linguistics, therefore, I must have been especially loved by the Goddess of Fortune to be able to have Diane as my forum paper supervisor. I have lost count of how many times I came to her, having no idea or too many ideas about what to do with my research, and yet walked out from her office, feeling completely inspired and enlightened. She is a *tagata taute tala* (Niuean: person tell story; story teller) who could always narrate a line of inquiry in the literature which is most relevant to the most pressing problem I was faced with. I would not have been able to write the paper without her help, support, and guidance throughout this year, and previous years, in various aspects.

I am also very honored to have Prof. Elizabeth Cowper, who is a great linguist and the supervisor of many great linguists such as Diane, my supervisor, as the second reader of my forum paper. She was also the supervisor of Lisa Lai-Shen Cheng, whose forum paper was on *de*-constructions in Mandarin; more than thirty years have passed, nominal phrases where a *de* particle is present still fascinate young researchers such as myself.

My love for Linguistics is rooted in every linguist I have met during my time at the University of Toronto. I want to especially thank Julien Carrier, my TA for Intro to Linguistics, Alex Motut and Rebecca Tollan, my instructor and my TA for second year syntax (Government and Binding), Prof. María Christina Cuervo, my instructor for third year syntax (Minimalism), Prof. Susana Béjar, my instructor for advanced syntax, and Prof. Nicholas Welch, my instructor for advanced morpho-syntax. I would also like to thank every member of my cohort: Kelly-Ann Blake, Andrea Boom, Brea Lutton, Kinza Mahoon, Savannah Meslin, Andrei Munteanu, Sarah Newman, Jessica Yeung, and Luke Zhou: my forum paper would not have been progressed so smoothly without all the forum meetings which were led by Prof. Michela Ippolito and Prof. Sali Tagliamonte. In addition, I was very fortunate to be able to present various parts of my

ongoing research at the *Syntax Project*, *MOTH*, *CLA*, and *Roots*: I am especially grateful to Prof. Ivona Kučerová, who was among the audience of every presentation of mine, for providing me with very constructive comments and suggestions; I am also very grateful to Prof. Susana Béjar, Prof. Elizabeth Cowper, Prof. María Christina Cuervo, Prof. Arsalan Kahnemuyipour, Sherry Yong Chen (a.k.a my “syntax twin”, if that is a thing), Julianne Doner, Brea Lutton, and Kinza Mahoon for inspiring me in various aspects. A special thanks is also extended to Keren Deng, my English teacher for grades 7 to 9, without whom I would not have been able to write as long as 28,500 words in English.

The past four years at U of T have been a highlight of my life. I want to especially thank Luke West, who is the first friend and linguist I met here, and Luke Zhou, for being the best study buddy (I have lost count of how many times we studied at the linguistics lounge or the GYM of my apartment until after midnight) and eating buddy (for all kinds of ice cream, cheesecake, sushi, pasta, and curry) that I could ask for. I am also very grateful to Mary Hsu and Esther Kim, who are especially loving and caring, for providing me with emotional support and life wisdom. I also want to express my gratitude to William Chen, Cynthia Dong, and Vicky Chen, as well as Jianxi Wu and Linlan Wang, for taking care of me throughout my time here, in addition to Xi Sanderson and her family, Song Dai, and Qian Tong for making me feel I have so many homes away from home. Special thanks also go to my roomie, Vivian Lam, and my ex-roommate, Stephanie Wong: they are the best!

Last but not least, I am very grateful to my dad, Zhijun Chen, for supporting me unconditionally to pursue my dreams, and my little brother, Oliver Chen, who is absolutely a genius, for challenging me intellectually throughout our growth. I would also like to thank my mom, Keyi Zhao, who has been my language consultant and research assistant throughout this year, for always being patient, supportive, and inspiring. I want to especially thank Weiwei Li, who has been an important family member of mine since I was in grade 9, for being my father, big brother and friend, and more importantly, the soulmate of my mom.

Since very young, I am often asked why I named myself Cater, I mean, Caterpillar (I guess I didn’t know that *caterpillar* is opaque). I would always respond by saying “Because I wish I could become a butterfly one day”. While I still regard myself as an underspecified Root, I wish that, one day, I could be proud and say “I have become an nP linguist”.

List of key figures

- | | | |
|------|---|-------|
| (25) | The syntactic derivation of a non-predicative <i>de</i> -construction (<i>hun-an de yue-liang</i> ‘dim moon’) where an AP (<i>hun-an</i> ‘dim’) modifies an NP argument (<i>yue-liang</i> ‘moon’). | 28 |
| (30) | The morphological derivation of a right-headed X-N compound with compositional interpretation, a schema of. | 36 |
| (31) | The morphological derivation of a right-headed X-N compound with idiosyncratic interpretation, a schema of. | 38 |
| (32) | The morphological derivation of a left-headed N-X compound where the non-head element is interpreted as non-restrictive, a schema of. | 39 |
| (35) | The morphological derivation of a right-headed A-N compound (<i>lan tian</i> ‘blue sky’) where the non-head A (<i>lan</i> ‘blue’) and the head N (<i>tian</i> ‘sky’) are interpreted compositionally. | 41-42 |
| (36) | The morphological derivation of a right-headed A-N compound (<i>bai cai</i> ‘cabbage’) where the non-head A (<i>bai</i> ‘white’) and the head N (<i>cai</i> ‘vegetable’) are interpreted idiosyncratically. | 43 |
| (39) | The morphological derivation of a right-headed N-N compound (<i>qiu chang</i> ‘stadium’) where the non-head N (<i>qiu</i> ‘ball’) and the head N (<i>chang</i> ‘field’) are interpreted compositionally. | 45 |
| (40) | The morphological derivation of a right-headed N-N compound (<i>bang qiu</i> ‘baseball’) where the non-head N (<i>bang</i> ‘bat’) and the head N (<i>qiu</i> ‘ball’) are interpreted idiosyncratically. | 46 |
| (44) | The morphological derivation of a left-headed N-A compound (<i>yue liang</i> ‘moon’), where the non-head A (<i>liang</i> ‘bright’) is interpreted as non-restrictive. | 50 |
| (45) | The morpho-syntactic derivation of a non-predicative <i>de</i> -construction (<i>hun-an de yue-liang</i> ‘dim moon’), the NP argument of which is an endocentric nominal compound (<i>yue-liang</i> ‘moon’). | 51 |
| (52) | The D-structure of the morpho-syntactic derivation of a generic <i>de</i> -construction (<i>kai che de</i> ‘driver’) where the V (<i>kai</i> ‘drive’) and the NP/the internal argument of the V (<i>che</i> ‘vehicle’) proceed from two different morphological derivations. | 60 |

- (53) The S-structure of the morpho-syntactic derivation of a generic *de*-construction (*kai che de* ‘driver’) where the VP (*kai che* ‘drive vehicles’) surfaces to the left of the *de* particle. 61
- (60) The morphological derivation of a synthetic nominal compound (*sheng qi shou* ‘flag raiser’) where the V (*sheng* ‘raise’) surfaces to the left of its internal argument (*qi* ‘flag’). 69-70
- (61) The morphological derivation of a synthetic nominal compound (*ge chang jia* ‘singer’) where the V (*chang* ‘sing’) surfaces to the right of its internal argument (*ge* ‘song’). 70-71
- (62) The morphological derivation of a synthetic nominal compound (*si ji* ‘driver’) where the n° which heads the highest nP is not subject to Vocabulary Insertion. 72-73
- (63) The morphological derivation of a synthetic nominal compound (*cheng guan* ‘city governor’) where the n° which heads the highest nP is not subject to Vocabulary Insertion. 74
- (64) The morphological derivation of a synthetic nominal compound, (*xie shou* ‘writer’) where the nP complement of the Root which heads the \sqrt{P} is not subject to Vocabulary Insertion. 75
- (65) The morphological derivation of a synthetic nominal compound, (*qiu shou* ‘ball player’) where the Root which heads the \sqrt{P} is not subject to Vocabulary Insertion. 76
- (86) The morphological derivation of a right-headed V-N compound, (*shi ke* ‘eater’) where the non-head V (*shi* ‘eat’) and the head N (*ke* ‘person’) are interpreted compositionally. 101

Pine tree tops

In the blue night
frost haze, the sky glows
with the moon
pine tree tops
bend snow-blue, fade
into sky, frost, starlight.
The creak of boots.
Rabbit tracks, deer tracks,
what do we know.

-- Gary Snyder

The syntax of nominal phrases and the morphology of nominal compounds
in Mandarin (Chinese): A comparative study

Chapter 1 A single Spell-Out model of morpho-syntax

This paper sheds light on the nature of modification and nominalization and their relation to argument structure through a comparative study of the syntactic derivation of two types of nominal phrases (non-predicative *de*-constructions and generic *de*-constructions) and the morphological derivation of the corresponding nominal compounds (endocentric nominal compounds and synthetic nominal compounds) in Mandarin (Chinese).

Specifically, it will be proposed that non-predicative *de*-constructions, as exemplified in (1a), (1b), (1c) and (1d), share the same syntactic derivation, where the inversion of the XP and the NP takes place when the XP raises from the complement of an *xP*, which is an extended projection of the XP, to the specifier of a *deP*, such that the XP may serve as a restrictive modifier of the NP. In comparison, left-headed N-X compounds, such as (1a'), are formed when neither pseudo-incorporation nor head movement takes place, while a right-headed X-N compound, such as (1b'), (1c'), or (1d'), may be formed when *xP*-to-Root pseudo-incorporation or *x*^o-to-Root head movement takes place. It will be suggested that the similarity between the syntactic derivation of non-predicative *de*-constructions (2a) and the morphological derivation of the corresponding endocentric nominal compounds (2b) may have consequences for the nature of modification and its relation to argument structure.

- (1) a. [AP *hun-an*] *de* [NP *yue-liang*] a'. *yue* *liang*
 dim moon moon₁ bright_i
 ‘dim moon’ ‘moon’
- b. [NP *bang-qiu*] *de* [NP *qiu-chang*] b'. *bang* *qiu*
 baseball stadium bat₁ ball_i
 ‘baseball’s stadium’ ‘baseball’
- c. [VP *chi* *dong-xi*] *de* [NP *ren*] c'. *shi* *ke*
 eat things person eat₁ person_i
 ‘thing-eating person’ ‘eater’
- d. [VP *chi*] *de* [NP *dong-xi*] d'. *shi* *wu*
 eat thing eat₁ thing_i
 ‘things to eat’ ‘food’

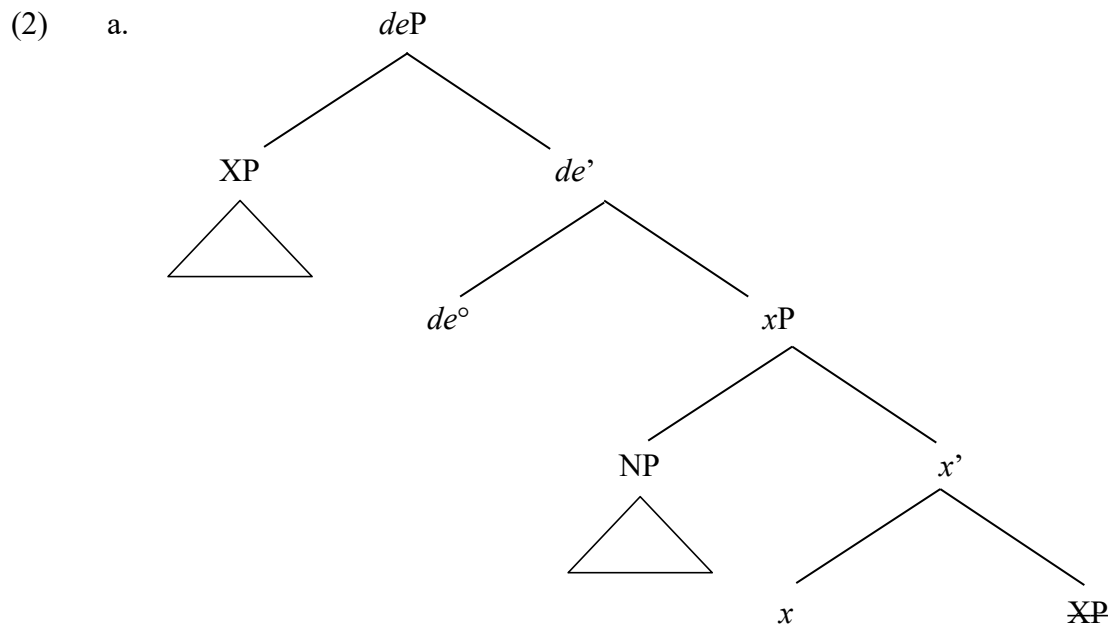

b.

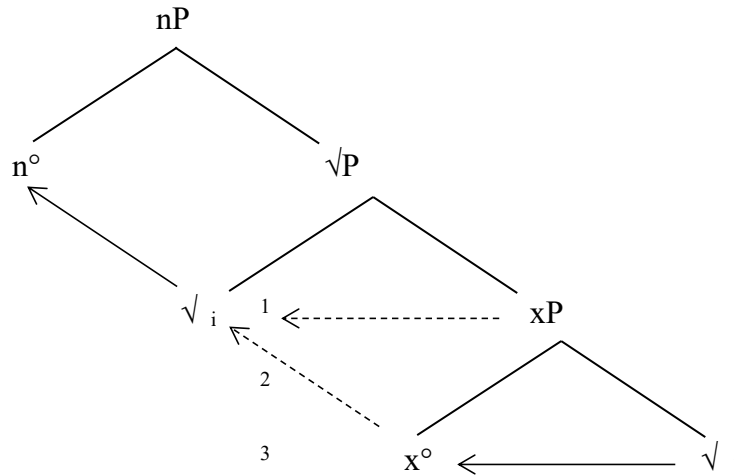

It will further be proposed that generic *de*-constructions, where a VP surfaces to the left of a *de* particle, as exemplified in (3a) and (3b), are formed when a *de*^o nominalizes a *v*P, which is an extended projection of the VP. In the morphological derivation of the corresponding synthetic nominal compounds, as exemplified in (3a') and (3b'), it will be proposed that the *√*P in which the Roots which are regarded as the V and its internal argument are embedded is verbalized prior to nominalization. It will be suggested that the similarity between the syntactic derivation of generic *de*-constructions (4a) and the morphological derivation of the corresponding synthetic nominal compounds (4b) may have consequences for the nature of nominalization and its relation to argument structure.

- | | | | | | | | | |
|-----|----|-------------------------------|-----------------------------|-----------|-----|--------------------|-------------------|-------------|
| (3) | a. | [_V <i>sheng</i>] | [_{NP} <i>qi</i>] | <i>de</i> | a'. | <i>sheng</i> | <i>qi</i> | <i>shou</i> |
| | | raise | flag | | | raise _i | flag ₁ | |
| | | 'flag raiser' | | | | 'flag raiser' | | |

¹ Pseudo-incorporation.

² Or x^o-to-Root head movement.

³ Or neither.

In this chapter, I will outline a single Spell-Out model of morpho-syntax which integrates theories of Government and Binding, Minimalism, and Distributed Morphology. I will present some data from Mandarin which suggests a syntactic representation (nominal phrase) and the corresponding morphological representation (nominal compound) may result in different interpretations at LF or different Vocabulary Insertion processes at PF. Nevertheless, I propose that a single Spell-Out model of morpho-syntax which postulates that morphological and syntactic derivations may share one Numeration and one single Spell-Out may not only account for the mismatches between a syntactic representation and a morphological representation (with respect to LF interpretation and PF Vocabulary Insertion), but also meet the economy considerations from a minimalist perspective (compared to a multiple Spell-Out model where phases of a morpho-syntactic derivation are transferred to LF and PF via multiple Spell-Out).

1.1 Aspects of the theories of syntax

The Government and Binding theory (Chomsky 1981) postulates a Y model (5) where a syntactic representation is built through Merge (D-structure) and Move (S-structure),⁶ prior to its interfaces with semantic representation (LF) and phonological representation (PF).

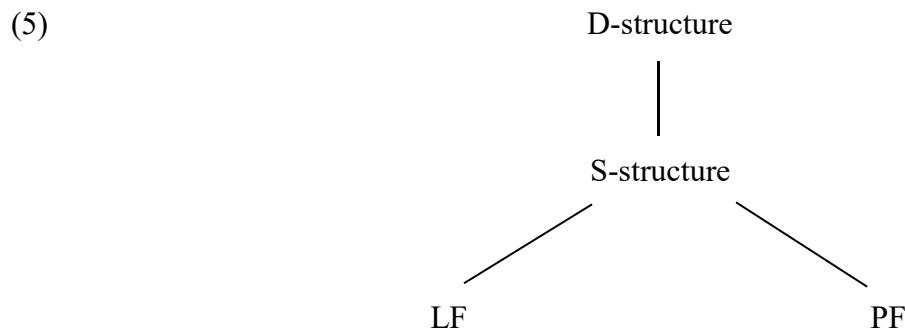

⁶ It is assumed that D-structure and S-structure are not distinct levels of representation (à la Minimalism); however, the thesis may refer to D-structure and S-structure for referencing purposes.

Terminal nodes of a syntactic representation consist of two kinds: Lexical categories and grammatical categories. Lexical categories, such as adjectives (A), nouns (N), and verbs (V), are well-formed words which are specified for both semantic and phonological content. On the other hand, grammatical categories primarily serve grammatical functions. It is assumed that both kinds of terminal nodes are heads of their own projections.

Within Minimalism (Chomsky 1993), it is assumed that terminal nodes which enter into a derivation are individuated in a Numeration. Merge is binary, i.e., takes place between two elements; the element X which selects the other element is the head and projects. The maximal projection (XP) of a head X may consist of one complement, which is the sister of the X, and one specifier, which is the sister of an intermediate projection of the X (X'). The complement and the specifier of an XP are maximal projections of some other heads. Notably, the structural relation among the specifier, the head, and the complement of an XP is asymmetric; that is, the specifier of an XP asymmetrically c-commands the head X, and X also asymmetrically c-commands terminal nodes which are dominated by the complement of the XP.

Kayne (1994) suggests that terminal nodes of a syntactic representation are linearized such that a terminal node X precedes a terminal node Y if and only if X is dominated by a node which asymmetrically c-commands Y or a node that dominates Y (a.k.a Linear Correspondence Axiom). To this end, Kayne (1994) suggests that the specifier of an XP should always surface to the left of the X', whereas the complement of an XP should always surface to the right of the head X, such that the directionality of c-command relation matches the linear ordering of the terminal nodes which are dominated by the specifier of an XP, the head X, and the terminal nodes which are dominated by the complement of the XP.

Minimalism (Chomsky 1993) also assumes a copy theory of movement, according to which the positions where a node moves to and from contain a higher and a lower copy of the node. Each time a node moves, the higher and the lower copy of the node form a chain link. Because LF and PF are separated as two independent sub-derivations, which copy is interpreted at LF or pronounced at PF is determined independently. While lower copies of the node may be interpreted at LF, it is assumed that all but the highest copy of the node is generally deleted such that only the highest copy of the node is pronounced at PF.

Movement is minimal, such that chain links should be minimized (a.k.a Economy of Derivation) (Chomsky and Lasnik 1993). For example, head movement of X to Y cannot “skip” an intervening head Z (a.k.a Head Movement Constraint); that is, X may only move into Y if XP is in the complement of YP (Travis 1984). Head movement results in head adjunction; specifically, an X which moves into Y becomes an adjunct of Y. Chomsky (1993) suggests that head movement is feature-driven. Notably, Chomsky (1993) also suggests that non-interpretable features must be checked in the derivation, otherwise resulting in ungrammaticality; therefore, it may be postulated that the movement of a head X to a head Y is driven by some non-interpretable feature in X, which must be checked against some other feature in Y.

On the other hand, Grohmann (2003) suggests that movement must not be too local, such that each chain link must be at least of length 1, where a chain link is of length n if there are n maximal projections which dominate the higher copy of the node but not the lower copy of the node (a.k.a Anti-Locality Hypothesis). For example, the complement of an XP cannot move to the specifier of the same XP, because the chain link would be 0. On the other hand, the most local position to which the complement of the XP may move is the specifier of a YP which the XP is a complement of, in which case the chain link is 1.

1.2 Morphology as syntax

Words, which are represented as syntactic terminal nodes, are not the smallest grammatical units; morphemes are. In other words, a word may be composed of various morphemes. The Distributed Morphology framework (Halle and Marantz 1993) postulates a Y model of word composition (6). Morphemes, which are the smallest grammatical units, are represented as terminal nodes from which the D-structure and the S-structure of a morphological representation are built by means of Merge and Move. The semantic interpretation of the word is determined at LF based on the S-structure. On the other hand, the sub-derivation on the way to PF prepares a morphological structure (MS) from which the phonological representation of the word is realized by means of Vocabulary Insertion.

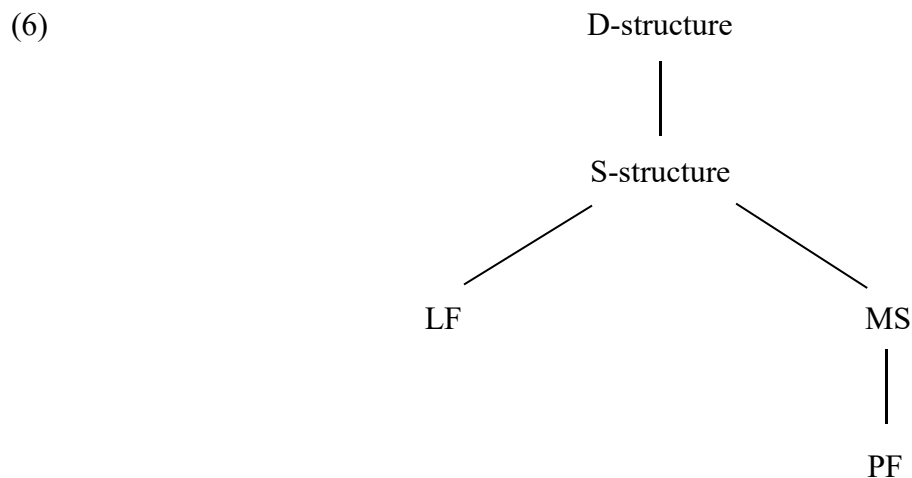

Terminal nodes of a morphological representation, i.e., morphemes, consist of two kinds: Roots ($\sqrt{\quad}$) and feature bundles. Roots are elements which are interpreted with lexical content at LF, whereas feature bundles primarily serve grammatical functions. Roots are acategorical, needing to Merge with a category-creating feature bundle (x°), such as an adjectivalizing head (a°), a nominalizing head (n°), or a verbalizing head (v°), to be categorized as an adjective (aP), a noun (nP), or a verb (vP). A categorized aP, nP, or vP may be recategorized as an xP by

merging with some other x° (Marantz 2001). Harley (2014) suggests that Roots are syntactically individuated, such that a Root may merge with an xP as its complement and heads a \sqrt{P} .⁷ Subsequently, the \sqrt{P} is subject to categorization and recategorization.

At LF, terminal nodes of the S-structure of a morphological derivation may be interpreted compositionally or idiosyncratically. Marantz (2001; 2007) suggests that each x° is a phase head, and the interpretation of the highest xP which is formed in a morphological derivation proceeds phase by phase in a cyclic manner. Specifically, “Roots are assigned an interpretation in the context of the first x° , or phase head, that merges with them, which is then fixed throughout the derivation” (see also Arad 2003; 2005). This suggests that the first xP in which a Root is embedded may be regarded as the domain for non-compositional interpretation. In other words, Roots must be interpreted compositionally when each of them is embedded in a different xP /domain for non-compositional interpretation. On the other hand, Roots may be interpreted idiosyncratically if they are embedded in the same xP /domain for non-compositional interpretation.

The MS is postulated to resolve the lack of isomorphism between S-structure and PF. That is, there may not be a one-to-one correspondence between terminal nodes of an S-structure and the corresponding PF. Halle and Marantz (1993) suggest that morphological operations, such as Morphological Merger and Fusion, may reorder or delete terminal nodes in the MS, such that there is a one-to-one correspondence between terminal nodes of the MS and the corresponding PF. Although both Morphological Merger and Fusion take place whereby a terminal node X adjoins to another terminal node Y , the adjunction of X (adjunct of Y) and Y as a result of Morphological Merger may surface as XY ; by contrast, only X (Y) would be subject

⁷ This is debatable; see footnote 38.

to Vocabulary Insertion if Y (X) is fused into X (Y). Notably, morphological operations are constrained by strict locality conditions, such as sisterhood or government.

Harley (2009) suggests that a Root which is in the complement of an xP may incorporate into the x° by means of incorporation (à la Baker 1988). Taking a step further, I suggest that a non-terminal xP or \sqrt{P} which is in the complement of a \sqrt{P} or xP is also subject to “incorporation” into the head of the \sqrt{P} (i.e., a Root) or the xP (i.e., an x°). Such movement will be referred to as “pseudo-incorporation” (cf. Massam 2001). I assume that head movement, incorporation, and pseudo-incorporation all result in inversion, conforming to Morphological Merger. In addition, head movement, incorporation, or pseudo-incorporation may also result in Fusion, although which element is fused into the other element may be determined on a case-by-case basis.

It is assumed that the phonological content of each terminal node of an MS is not realized until after Spell-Out (Halle and Marantz 1993). At PF, every terminal node of an MS is realized with some phonological content by means of Vocabulary Insertion. Halle and Marantz (1993) suggest that Vocabulary Items (VIs), i.e., the phonological content of a terminal node, are only specified for a subset of the morpho-syntactic features that constitute the terminal node; consequently, several VIs may compete to be inserted to a terminal node. In dealing with suppletive allomorphy, the competition is subject to the Subset Principle; specifically, the suppletive VIs which are more specified are inserted in specific contexts, whereas the default VI which is less specified is inserted elsewhere (Halle 1997). In dealing with contextual allomorphy, it is suggested that suppletive VIs may also be contextually specified, such that the insertion of a VI to a terminal node may be conditioned by the features of another terminal node (Halle and Marantz 1993).

Bobaljik (2000) suggests that Vocabulary Insertion is cyclic, such that structurally more embedded terminal nodes are realized before terminal nodes which are structurally less embedded. In this respect, the insertion of a VI to a less embedded terminal node may be dependent on the VI inserted in a more deeply embedded terminal node but not vice versa, conforming to the No Lookahead Condition (Simpson and Withgott 1986). In Bobaljik (2012), it is further suggested that VIs may only be contextually dependent on the features contained within the same complex head X, and not by features across an XP boundary (a.k.a The Complex Head Accessibility Domain). This suggests that each terminal node of a syntactic derivation may be regarded as the domain for contextual allomorphy. I suggest that the cyclicity of Vocabulary Insertion among syntactic terminal nodes, each of which is a domain for contextual allomorphy, may account for the fact that words must be free morphemes; in other words, Roots and x° must be realized with a free morpheme when each of them is embedded in a different syntactic terminal node/domain for contextual allomorphy. On the other hand, I suggest that Vocabulary Insertion within each syntactic terminal node/domain for contextual allomorphy is free, such that the fact that a morpheme is bound does not imply that it is structurally less embedded; in other words, Roots and x° may be realized with morphemes which are bound to the left or to the right if they are embedded in the same syntactic terminal node/domain for contextual allomorphy.

1.3 Mismatches between syntax and morphology: Evidence from Mandarin

It seems that a syntactic representation (nominal phrase) and the corresponding morphological representation (nominal compound) may result in different interpretations at LF or different Vocabulary Insertion processes at PF, as evidenced from Mandarin.

With respect to LF interpretation, the interpretation of a non-predicative *de*-construction, where an XP modifies an NP, as exemplified in (7a), (7b), and (7c), may only be compositional; specifically, the AP in each nominal phrase is interpreted as a restrictive modifier of the NP. By contrast, the interpretation of the corresponding endocentric nominal compound may be compositional, as in (7a'), in which case the right-headed A-N compound has the same interpretation as its phrasal counterpart (7a), or idiosyncratic, as in (7b'), in which case the right-headed A-N compound does not have the same interpretation as its phrasal counterpart (7b), because the A does not serve as a modifier of the N⁸. In addition, the non-head A in a left-headed N-A nominal compound is interpreted as non-restrictive, as exemplified in (7c').

(7)	a.	<i>lan</i>	<i>de</i>	<i>tian</i>	a'.	<i>lan</i>	<i>tian</i>
		blue		sky		blue	sky
		'blue sky'				'blue sky'	
	b.	<i>bai</i>	<i>de</i>	<i>cai</i>	b'.	<i>bai</i>	<i>cai</i>
		white		vegetable		white	vegetable
		'white vegetable'				'cabbage'	
	c.	<i>hun-an</i>	<i>de</i>	<i>yue-liang</i>	c'.	<i>yue</i>	<i>liang</i>
		dim		moon		moon	bright
		'dim moon'				'moon' <i>cf.</i> 'bright moon'	

With respect to PF Vocabulary Insertion, there may be a lack of isomorphism between a generic *de*-construction, where a VP surfaces to the left of a *de* particle, as exemplified in (8a), (8b), (8c), and (8d), and the corresponding synthetic nominal compound, as exemplified in (8a'), (8b'), (8c') and (8d'). Specifically, the *de* particle in (8a) and (8b) does not have any

⁸ It is debatable whether 'white' serves as a modifier of 'vegetable' in 'cabbage' (7b'). I posit that it doesn't, such that there is a clear, three-way distinction among (7a'), (7b'), and (7c').

correspondence in (8a') and (8b'); the VI for the internal argument of the V 'write', 'article', in (8c), does not have any correspondence in (8c'); and the VI for the V 'hit' in (8d) does not have any correspondence in (8d'). In addition, notice that different VIs for 'drive' and 'vehicle' are used in (8a'). While *kai* and *che* (8a) are free morphemes, *si* is bound by *ji* and vice versa (8a').⁹

(8)	a.	<i>kai</i>	<i>che</i>	<i>de</i>	a'.	<i>si</i>	<i>ji</i>
		drive	vehicle			drive	vehicle
		'driver'				'driver'	
	b.	<i>guan-li</i>	<i>cheng-shi</i>	<i>de</i>	b'.	<i>cheng</i>	<i>guan</i>
		govern	city			city	govern
		'city governor'				'city governor'	
	c.	<i>xie</i>	<i>wen-zhang</i>	<i>de</i>	c'.	<i>xie</i>	<i>shou</i>
		write	article			write	
		'writer'				'writer'	
	d.	<i>da</i>	<i>bang-qiu</i>	<i>de</i>	d'.	<i>bang-qiu</i>	<i>shou</i>
		hit	baseball			baseball	
		'baseball player'				'baseball player'	

In addition to the mismatches between a syntactic representation and a morphological representation with respect to LF interpretation and PF Vocabulary Insertion, it should also be noted that syntactic derivations and morphological derivations also differ with respect to how Merge and Move work. Specifically, Merge in syntactic derivations distinguishes among specifier, head, and complement positions; by contrast, Merge in morphological derivations only takes place between a head and a complement. Moreover, movements in syntactic derivations

⁹ Because all constructions in (58) are ungrammatical (see Section 3.2.1). In addition, see Section 3.2.4.

must not violate anti-locality; by contrast, head movement, incorporation and pseudo-incorporation in a morphological derivation are constrained by strict locality conditions.

1.4 A single Spell-Out model of morpho-syntax

Chomsky (2001) suggests that derivations proceed by phases; consequently, Spell-Out also proceeds in a piecemeal fashion. That is, at the point of a derivation where a phase is formed from elements in the Numeration, the complement domain of the phase head will be transferred to LF and PF via Spell-Out. Because the derivation of each phase is followed by a Spell-Out, a derivation of multiple phases entails multiple Spell-Outs (9) (Sato 2012).

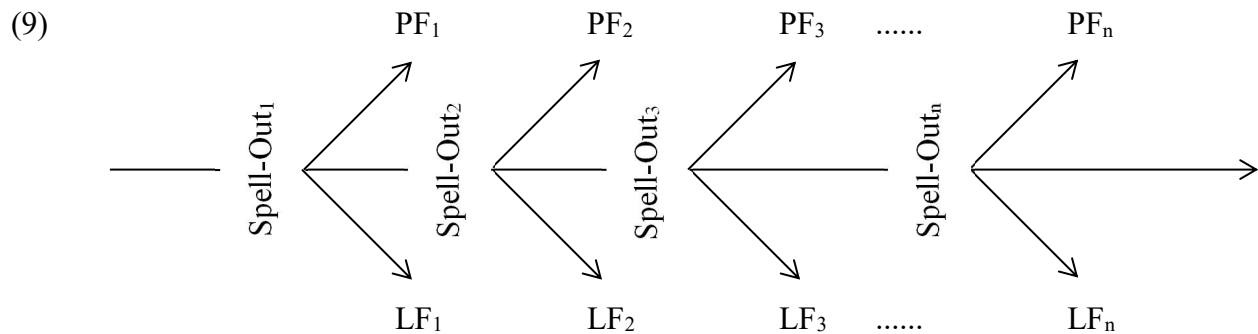

I propose that syntactic derivation and morphological derivation, each of which works differently with respect to Merge and Move, may be regarded as different phases of one morpho-syntactic derivation. In this respect, morphological derivations and syntactic derivations would share one Numeration. Specifically, I suggest that morphological derivations proceed to syntactic derivations via Renumeration (*cf.* Johnson 2003); that is, the highest xP formed in each morphological derivation would reenter the Numeration as an X or XP, thereby the X or XP may be selected in a following syntactic derivation. This means that the highest xP formed in each morphological derivation is no longer a part of the (morpho-syntactic) derivation once Renumeration has taken place; on the other hand, I assume that the X or XP which is

renumerated from the xP would be regarded as a syntactic terminal node, along with other grammatical categories, when it is selected in a syntactic derivation. In particular, I suggest that the highest xP formed in a morphological derivation may also reenter the Numeration as a Root, in which case the Root would be selected in a subsequent morphological derivation (*cf.* Harley 2009).

I further propose that syntactic derivations and morphological derivations may share one single Spell-Out (10); that is, morphological derivations need not be transferred to LF and PF via Spell-Out before the highest xP which is formed in each morphological derivation reenters a following syntactic derivation. This meets the economy considerations from a minimalist perspective¹⁰. Consequently, terminal nodes of a morphological derivation are not interpreted at LF, and Vocabulary Insertion does not take place at PF until after the syntactic derivations which proceed from the morphological derivations have also terminated. In other words, Roots and x° , which are the smallest grammatical units and terminal nodes of the morpho-syntactic derivation, are interpreted at LF and pronounced as PF at the same time.

¹⁰ Because the Minimalism Program “takes language to be a non-redundant computational system that disallows any superfluous steps or symbols in derivation and representation” (Sato 2010), I suggest that it is redundant to have multiple Spell-Out if one single Spell-Out is sufficient; in other words, additional Spell-Out are superfluous steps which should be disallowed.

Nevertheless, it should be acknowledged that a multiple Spell-Out model may be considered more economic for other reasons; for example, having multiple Spell-Out may “significantly reduce computational complexities in that the syntactic computation can forget about material once it has been transferred to the interpretive systems” (Sato 2010).

(10)

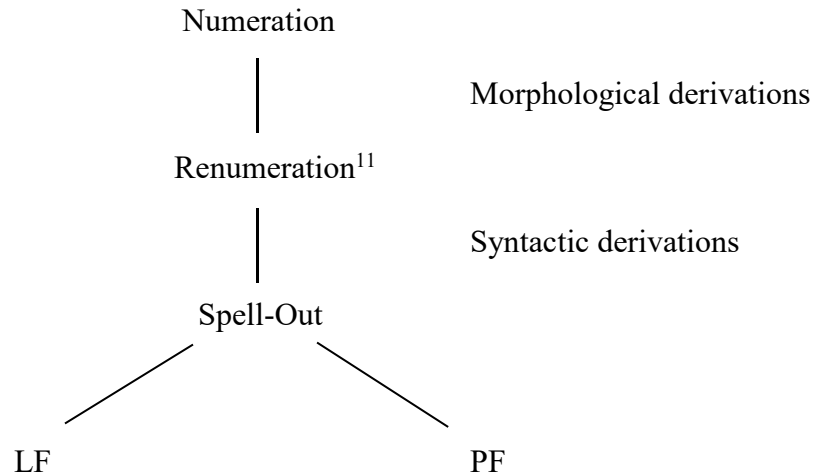

With respect to LF interpretation, I propose that a non-terminal XP is interpreted based on its internal structure, i.e., the specifier, the head, and the complement of the XP, conforming to principles of compositionality e.g., semantic type theory (Kratzer and Heim 1998). On the other hand, a terminal X or XP is interpreted based on the internal structure of the x° which heads the highest xP formed in each morphological derivation which reenters the Numeration as the X or the XP, because the xP no longer plays a part in the morpho-syntactic derivation. Specifically, I suggest that the first xP in which a Root is embedded may be regarded as the domain for non-compositional interpretation, and Roots must be interpreted compositionally when each of them is embedded in a different xP/domain for non-compositional interpretation. On the other hand, Roots may be interpreted idiosyncratically if they are embedded in the same xP/domain for non-compositional interpretation (à la Marantz 2001; 2007).

I suggest that the lack of isomorphism between a nominal phrase and its corresponding nominal compound may indicate that morphological operations (such as Morphological Merger and Fusion) have taken place in the morphological derivation of the nominal compound (à la Halle and Marantz 1993). With respect to PF Vocabulary Insertion, I propose that each terminal

¹¹ While there is only one Numeration and one Spell-Out, there can be multiple Renumerations.

node of a syntactic derivation, including an X or XP which is renumerated from the highest xP formed in a preceding morphological derivation, is a domain for contextual allomorphy (à la Bobaljik 2000; 2012). Specifically, I suggest that Roots and x° are realized with phonological content in a cyclic manner if each of them is embedded in a different syntactic terminal node/domain for contextual allomorphy, such that each of the Root must be realized with a free morpheme. On the other hand, Roots and x° are realized with phonological content freely if they are embedded in the same syntactic terminal node/domain for contextual allomorphy, such that each of the Roots may be realized with a morpheme which is bound to the left or to the right.

1.5 A comparative study of Mandarin nominal phrases and nominal compounds

The paper seeks to study the syntactic derivation of two specific types of nominal phrases and the morphological derivation of the two corresponding types of nominal compounds in Mandarin, and compare each type of nominal phrases with the corresponding nominal compounds with respect to LF interpretation, PF Vocabulary Insertion and derivation (D-structure and S-structure). The paper seeks to answer two major questions:

- I. How are the mismatches between each type of nominal phrases and the corresponding nominal compounds in Mandarin (with respect to LF interpretation and PF Vocabulary Insertion) accounted for by the single Spell-Out model of morpho-syntax?
- II. Despite the fact that syntactic derivation and morphological derivation differ with respect to how Merge and Move work, to what extent is the morphological derivation of each type of nominal compounds similar to the syntactic derivation of the corresponding nominal phrase?

The paper is organized as follows:

In Chapter 2, the syntactic derivation of non-predicative *de*-constructions (where a *de* particle is present between an XP modifier and an NP argument) and the morphological derivation of the corresponding endocentric nominal compounds will be studied and compared.

In Chapter 3, generic *de*-constructions (where a VP surfaces to the left of the *de* particle) and the corresponding synthetic nominal compounds will be studied and compared. Specifically, the syntactic derivation of generic *de*-constructions will be studied in comparison with that of non-predicative *de*-constructions. Similarly, the morphological derivation of synthetic nominal compounds will be studied in comparison with that of endocentric nominal compounds.

Chapter 4 will present partial analyses of several other types of nominal phrases and nominal compounds which require future research.

Chapter 5 will conclude with remarks on the single Spell-Out model of morpho-syntax and the similarities between the syntactic derivation of each type of nominal phrases and the morphological derivation of the corresponding nominal compound.

NP, and a *de* particle is required in between the XP modifier and the NP. Therefore, nominal phrases which surface as XP *de* NP are often referred to as *de*-constructions. By contrast, in predicative constructions where the NP may be regarded as a subject, the XP predicate immediately follows the NP subject. Such XPs, including complex APs, PPs, and finite Aspect phrases, are exemplified in (11), (12), and (13), respectively. Specifically, (11a), (12a), and (13a) are *de*-constructions, and (11b), (12b), and (13b) are the corresponding predicative constructions.

- (11) a. *hen hun-an de yue-liang*
 very dim moon
 ‘very dim moon’
- b. *yue-liang hen hun-an*
 moon very dim
 ‘Moon is very dim.’
- (12) a. *zai qiu-chang li de bang-qiu*
 PREP stadium in baseball
 ‘baseball in a stadium’
- b. *bang-qiu zai qiu-chang li*
 baseball PREP stadium in
 ‘A baseball is in the stadium.’
- (13) a. *da-le bang-qiu de qiu-yuan*
 hit-ASP baseball player
 ‘player who played baseball’

- b. *qiu-yuan* *da-le* *bang-qiu*
 player hit-ASP baseball
 ‘A player played baseball.’

den Dikken and Singhapreecha (2004) suggest that *de*-constructions are derived from the corresponding predicative construction through predicate inversion. Specifically, in the D-structure of *de*-constructions, a predicative construction, which is a small clause (SC), is formed when the NP subject merges with the XP predicate. The *de* particle, which realizes a de° , is responsible for the inversion of the XP. Specifically, the SC is further merged in the complement of a *de*P, and the XP predicate raises to the specifier of the *de*P, whereby the XP may serve as a restrictive modifier of the NP argument. Consequently, in the S-structure, the XP modifier may be linearized to the left of the *de* particle and the NP argument. The syntactic derivation from (11a) to (11b) is illustrated in (14).

(14)

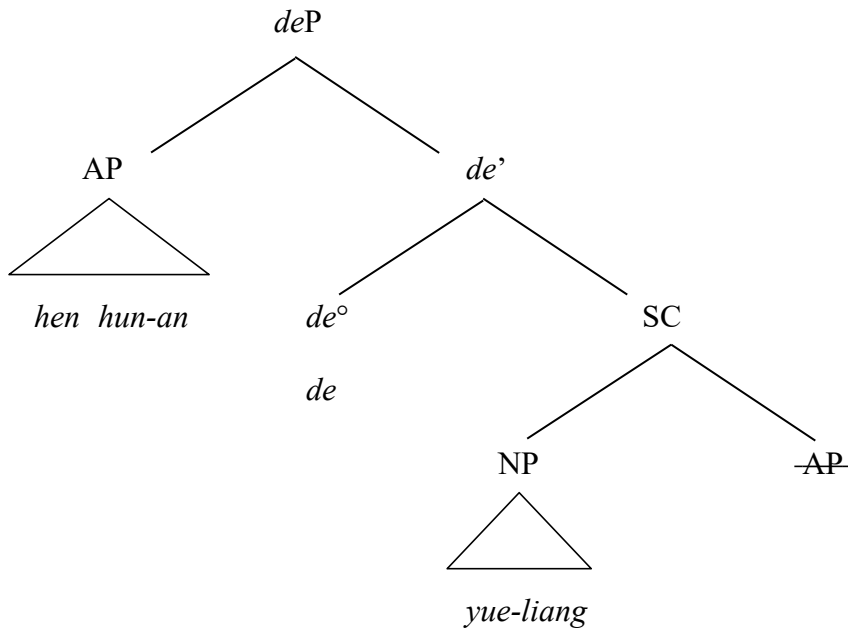

In the existing literature, the *de* particle has been analyzed as a VI which realizes various grammatical categories. Cheng (1986), among others, suggests that *de* realizes a complementizer (C) which heads a CP. Simpson (2002) suggests that *de* realizes a determiner (D) which heads a DP. Cheng and Sybesma (2009) suggest that *de* realizes an underspecified classifier which heads a classifier phrase. In the current study, the *de* particle is assumed to realize a de° which heads a *de*P, as shown in (14). While the semantics of the de° will be discussed in Section 2.1.5, I will leave the exact grammatical category the *de* particle realizes to future research.

2.1.2 Non-predicative *de*-constructions

Notably, a bare NP may also be modified by a simple AP (15a), an NP (16a), or a non-finite VP (17a) modifier, none of which can serve as a predicate of the NP, as shown in (15b), (16b), and (17b).

(15) a. *hun-an de yue-liang*

dim moon

‘dim moon’

b. **yue-liang hun-an*

moon dim

Intended: ‘Moon is dim.’

(16) a. *bang-qiu de qiu-chang*

baseball stadium

‘stadium of baseball’

- b. **qiu-chang bang-qiu*
 stadium baseball

Intended: ‘A stadium is for baseball.’

- (17) a. *da bang-qiu de qiu-yuan*
 hit baseball player
 ‘baseball-playing player’

- b. ?*qiu-yuan da bang-qiu*¹²
 player hit baseball

Intended: ‘A player is baseball-playing.’

The ungrammaticality of (15b), (16b), and (17b) suggests that non-predicative *de*-constructions, such as (15a), (16a), and (17a), should not be derived from predicative constructions through predicate inversion. In Section 2.1.3, I suggest that, in the D-structure of non-predicative *de*-constructions, the NP may be regarded as an external argument of the XP whereby it may receive the corresponding theta role in the specifier of an *xP*, which is an extended projection of the XP. In Section 2.1.4, I propose that, in the S-structure of non-predicative *de*-constructions, the XP is in the specifier of a *deP* such that the complement of the *deP* is subject to ellipsis. In Section 2.1.5, I further propose that the *xP* is in the complement of the *deP*, and the XP raises to the specifier of a *deP* from the complement of the *xP* whereby the XP may serve as a restrictive modifier of the NP argument. Last but not least, I posit that the ungrammaticality of (15b), (16b), and (17b) arises from a non-interpretable feature in *x*, which heads the *xP*, and the implication of *x*-to-*de*^o head movement will be discussed.

¹² This sentence might be acceptable as a generic expression in restrictive contexts.

2.1.3 Theta role and case

Baker (2003) suggests that the Theme of a V is an internal argument, whereas the Theme of an A or a N is an external argument. While the Theme of a V is assigned by the V itself, Chomsky (1995) suggests that an external argument of a V is introduced by the head of an extended projection of V. For example, it is suggested that the Agent of a V should be analyzed as not being assigned by the V itself, but rather, by a light verb (*v*) to the specifier of a *v*P, which may be regarded as an extended projection of the VP; in other words, the VP is in the complement of the *v*P. To this end, I suggest that the Theme of an A or a N is not assigned by the A or the N itself, but rather, by an *a* or a *n* to the specifier of an *a*P or an *n*P, which may be regarded as an extended projection of the AP or the NP; in other words, the AP or the NP is the complement of the *a*P or the *n*P.

Although the XP in non-predicative *de*-constructions is non-predicative, I propose that the NP may still be regarded as an external argument of the XP, which is introduced by an *x* which heads an *x*P (which is an extended projection of the XP); in other words, the XP is base-generated in the complement of the *x*P. In this respect, in the D-structure of non-predicative *de*-constructions, the NP is proposed to be base-generated in the specifier of an *x*P (18).

(18)

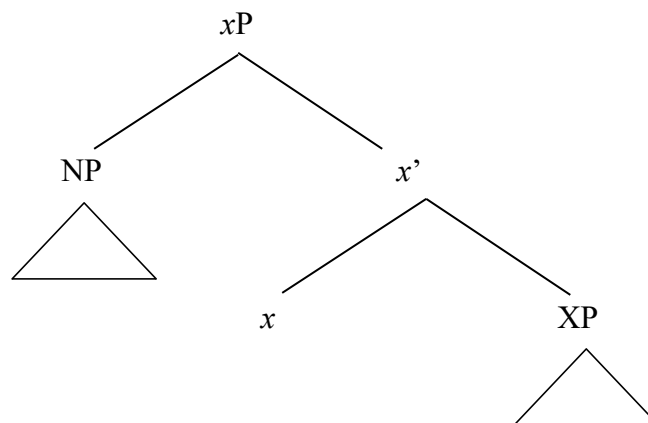

When the XP is an AP, the NP argument may be interpreted as a Theme of the AP (15a). When the XP is a VP, the NP argument may not only be interpreted as an Agent (17a), but also a Location (19a) or an Instrument (19b) of the VP, all of which are theta roles which may be assigned to an external argument of a VP.

- (19) a. *da* *bang-qiu* *de* *qiu-chang*
 hit baseball stadium
 ‘baseball-playing stadium’
- b. *da* *bang-qiu* *de* *qiu-bang*
 hit baseball ball bat
 ‘baseball-playing bat’

However, when the the XP is an NP, it is debatable as to what theta role the NP argument (which surfaces to the right of the *de* particle) receives, as shown in (20); on the other hand, the NP (which surfaces to the left of the *de* particle) seems to receive a genitive case. Evidently, Cheung (2006) suggests that the *de* particle may be regarded as a genitive case marker. Because Chomsky (1993) suggests that case is assigned uniformly to specifier positions, the NP which is base-generated in the complement of the *nP* in the D-structure ought to raise to the specifier of a *deP* to receive a genitive case. In Section 2.1.4, I suggest that every XP in non-predicative *de*-constructions is in the specifier or the *deP* such that the complement of the *deP* may be subject to ellipsis.

- (20) a. *bang-qiu* *de* *qiu-yuan* a'. *qiu-yuan* *de* *bang-qiu*
 baseball player player baseball
 ‘baseball’s player’ ‘player’s baseball’

b.	<i>bang-qiu</i>	<i>de</i>	<i>qiu-chang</i>	b'.	<i>qiu-chang</i>	<i>de</i>	<i>bang-qiu</i>
	baseball		stadium		stadium		baseball
	'baseball's stadium'				'stadium's baseball'		
c.	<i>bang-qiu</i>	<i>de</i>	<i>qiu-bang</i>	c'.	* <i>qiu-bang</i>	<i>de</i>	<i>bang-qiu</i>
	baseball		ball bat		ball bat		baseball
	'baseball's bat'				Intended: 'bat's baseball'		

2.1.4 Noun ellipsis

Saito, Lin and Murasugi (2008), among others, observe that the NP argument in *de*-constructions is subject to ellipsis when there is an antecedent in the preceding discourse. Similarly, the NP argument is also subject to ellipsis in non-predicative *de*-constructions, as exemplified in (21), (22), and (23).

(21) *da de qiu-chang shi qiu-yuan de.*

big stadium COP player

xiao de ~~qiu-chang~~ shi wo de.

small ~~stadium~~ COP 1.SG

'The big stadium is a player's. The small stadium is mine.'

(22) *qiu-yuan qu-le bang-qiu de qiu-chang.*

player go-ASP baseball stadium

wo qu-le lan-qiu de ~~qiu-chang~~.

1.SG go-ASP basketball ~~stadium~~

'A player went to a baseball stadium. I went to a basketball stadium.'

- (23) *da bang-qiu de qiu-chang hen da.*
 hit baseball stadium very big
da lan-qiu de ~~qiu-bang~~ hen xiao.
 hit basketball ~~stadium~~ very small

‘The baseball-playing stadium is very big. The basketball-playing stadium is very small.’

Saito and Murasugi (1990) suggest that the ellipsis of the complement of a maximal projection is allowed only when the specifier of the maximal projection is occupied. Therefore, I propose that, in the S-structure of non-predicative *de*-constructions, the XP is in the specifier of a *deP*, such that the complement of the *deP* is subject to ellipsis. Moreover, the NP must be embedded in the complement of the *deP*, such that NP ellipsis would follow from the ellipsis of the complement of the *deP* (24).

(24)

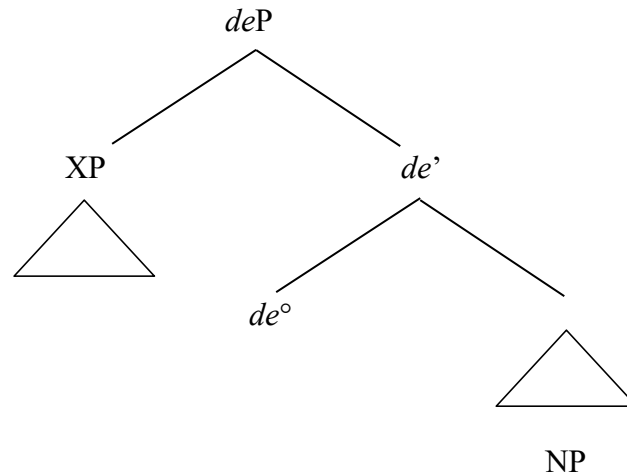

2.1.5 Discussion

I posit that the syntactic derivation schematized in (18) follows directly from the syntactic derivation schematized in (24). In other words, I propose that the *xP* in (18) is further merged in the complement of the *deP* in (24), and the *XP* which is base-generated in the

complement of the *xP* is raised to the specifier of the *deP*. To this end, it can be concluded that the *de*[°] in non-predicative *de*-constructions is also responsible for the inversion of the *XP*. Notably, the movement of the *XP* does not violate anti-locality, because the *xP* is a maximal projection which dominates the lower copy of the *XP* but not the higher copy of the *XP*, i.e., the chain link is 1. The syntactic derivation of (15a) is illustrated in (25). I assume that the *x* (which is specified as an *a* in (15a)) is realized with a phonologically null *VI*.

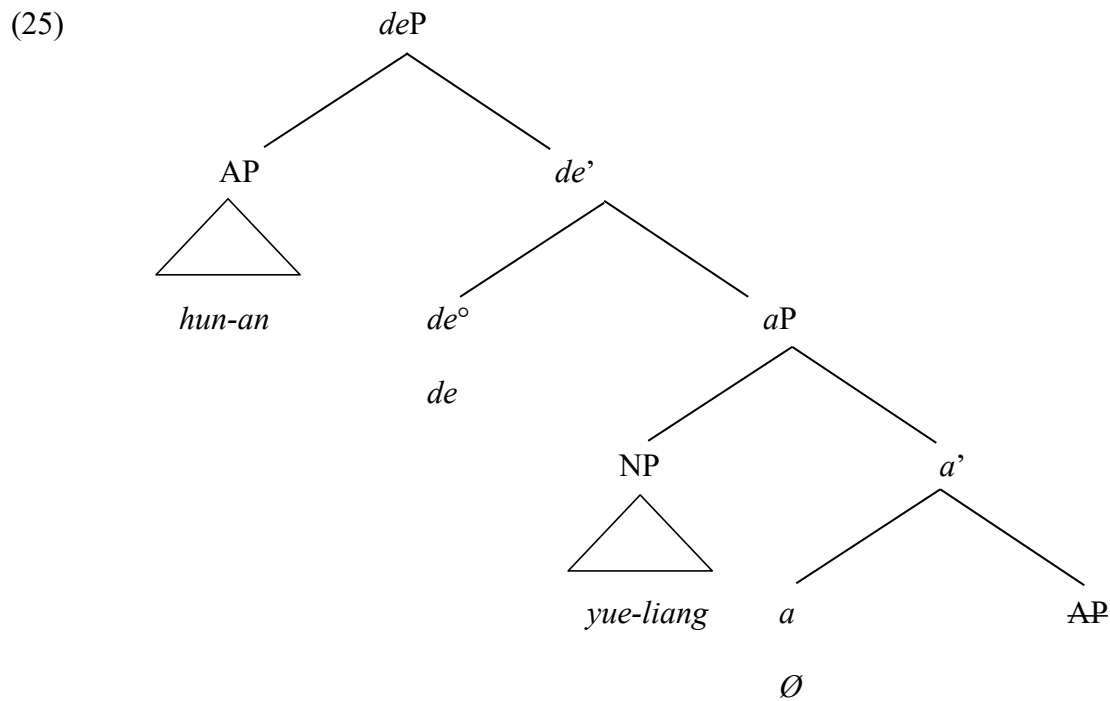

I further suggest that the *XP* (which is specified as an *AP* in (25)) in non-predicative *de*-constructions raises to the specifier of the *deP* so as to serve as a restrictive modifier of the *NP* argument. Compositionally speaking, Huang (2006) suggests that the *de*[°] is a type-shifter which is of type $\langle\langle e,t\rangle, e\rangle$. Because the *xP* is composed with the *de*[°], it follows that the *xP* must be of type $\langle e,t\rangle$, and the *de*' must be of type $\langle e\rangle$. It is also suggested by Huang (2006) that a restrictive modifier and the element which is being modified must be of the same semantic type in order for modification to take place. Since *de*' is of type $\langle e\rangle$, it follows that the *XP* which

raises to the specifier of the *de*P must also be of type $\langle e \rangle$,¹³ such that the XP may compose with the *de*' by means of modification.¹⁴ This confirms the non-predicative status of the XP in non-predicative *de*-constructions. Notably, as a result of modification, the *de*P is also of type $\langle e \rangle$; therefore, a *de*P may further serve as an argument, as evidenced by (21), (22), and (23).

Chierchia (1998) suggests that a type-shifter which is of type $\langle \langle e, t \rangle, e \rangle$ (a.k.a “down” operator) may also be regarded as a nominalizer. Therefore, it follows that de° may also serve as a nominalizer. In Chapter 3, it will be proposed that generic *de*-constructions are formed when de° nominalizes a *v*P, which is an extended projection of the VP.

On the other hand, recall that the NP in non-predicative *de*-constructions is expected to be interpreted as an argument in the D-structure. Compositionally speaking, the NP may be interpreted as an argument only when it saturates an argument of a predicate. Chierchia (1998) suggests that NPs in Chinese are of type $\langle e \rangle$. Because the XP in non-predicative *de*-constructions, which is base-generated in the complement of the *x*P, is also of type $\langle e \rangle$, I posit that the *x* is a three-place predicate, i.e., of type $\langle e, \langle e, \langle e, t \rangle \rangle \rangle$, and the NP saturates the second argument of the predicate, such that the *x*P may be of type $\langle e, t \rangle$, as expected.

I further suggest that the ungrammaticality of (11b), (12b), and (13b) may be because there is a non-interpretable feature in the *x*, which must be checked against some other feature in the de° via *x*-to- de° head movement. While this is only speculative, it should be noted that the proposal that the *x* may move to de° opens up the possibility for further movements of the *x*. Specifically, I suggest that cleft constructions may be analyzed as being derived from non-predicative *de*-constructions via scrambling.

¹³ It seems problematic to analyze a VP (and AP) as being of type $\langle e \rangle$. I will leave this problem to future research.

¹⁴ It is also debatable whether modification may take place between two $\langle e \rangle$ type elements, a line of inquiry I will leave to future research.

In Mandarin, each non-predicative *de*-construction, such as (15a), (16a), and (17a), can be reconstructed as two cleft constructions, as shown in (26), (27), and (28).

- (26) a. *yue-liang shi hun-an de yue-liang.*
 moon COP dim moon
 ‘It is the moon that is dim.’
- b. *hun-an de shi ~~hun-an~~ de yue-liang.*
 dim COP ~~dim~~ moon
 ‘What is dim is the moon.’
- (27) a. *bang-qiu shi qiu-chang de bang-qiu.*
 baseball COP stadium baseball
 ‘It is a baseball that is the stadium’s.’
- c. *qiu-chang de shi ~~qiu-chang~~ de bang-qiu.*
 stadium COP ~~stadium~~ baseball
 ‘What is the stadium’s is a baseball.’
- (28) a. *qiu-yuan shi da bang-qiu de qiu-yuan.*
 player COP hit baseball player
 ‘It is a player who is baseball-playing.’
- b. *da bang-qiu de shi ~~da bang-qiu~~ de qiu-yuan.*
 play baseball COP ~~play baseball~~ player
 ‘He who is baseball-playing is a player.’

Assuming that *x-to-de*^o head movement takes place across the board, I posit that the cleft constructions in (26a), (27a), and (28a) are derived from the corresponding non-predicative *de*-constructions, which are (15a), (16a), and (17a). Specifically, (26a), (27a), and (28a) are formed

when a third copy of the *x* merges with the *deP* and projects an *x'* which further merges with a copy of the NP argument and projects an *xP*. In other words, the *deP* is in the complement of the newly formed *xP*, and the NP argument raises from a lower *xP* which is in the complement of the *deP* to the specifier of the higher and newly formed *xP*. At PF, all but the highest copies are deleted.

I further propose that the cleft constructions in (26b), (27b), and (28b) are derived from the the cleft constructions in (26a), (27a), and (28a) via a further movement of the *x*; specifically, (26b), (27b), and (28b) are formed when a fourth copy of the *x* merges with the higher *xP* (which is formed in the syntactic derivation of the cleft constructions in (26b), (27b), and (28b)) and projects another *x'* which further merges with a copy of the *deP* and projects another *xP*. In other words, three copies of the *xP* are obtained in the entire derivation: The middle copy of the *xP* is in the complement of the highest *xP*, while the *deP* raises from the specifier of the middle copy of the *xP* to the specifier of the highest *xP*. Likewise, at PF, all but the highest copies are deleted.

Last but not least, notice that non-predicative *de*-constructions are recursive; namely, an NP argument may be modified by various XPs, as exemplified in (29).

(29) *da de, qiu-yuan de, da bang-qiu de qiu-chang*
 big player hit baseball stadium

‘big, player’s, baseball-playing stadium’¹⁵

To account for cases of recursion, I propose that the *deP* which is composed from the NP argument and the most embedded XP modifier may further be merged in the specifier of another *xP* which is an extended projection of a less embedded XP modifier of the NP argument; thereby,

¹⁵ The English translation may be considered ungrammatical (*cf.* ‘player’s big, basketball-playing stadium’). It is debatable whether there is a preference between (29) and *qiu-yuan de, da de, da bang-qiu de qiu-chang* in Mandarin. The potential asymmetry is subject to future research.

the *deP* may be regarded as an external argument of the XP and be assigned a corresponding theta role by the *x*. In the S-structure, the inversion of XP takes place whereby another *deP* would be formed.

For example, in (29), the NP *qiu-chang* is an external argument of the VP *da bang-qiu*, and receives an Instrument role from a phonologically null *v*. The *deP da bang-qiu de qiu-chang* is an external argument of the NP *qiu-yuan*, and receives a Theme role from a phonologically null *n*. Lastly, the *deP qiu-yuan de, da bang-qiu de qiu-chang* is an external argument of the AP *da*, and receives an Instrument role from a phonologically null *a*. In the S-structure, the VP *da bang-qiu* is interpreted as a restrictive modifier of the NP *qiu-chang*; the NP *qiu-yuan* is interpreted as a restrictive modifier of the *deP da bang-qiu de qiu-chang*; and the AP *da* is interpreted as a restrictive modifier of the *deP qiu-yuan de, da bang-qiu de qiu-chang*.

2.2 Endocentric nominal compounds in Mandarin

2.2.1 Endocentric nominal compounds in English

In endocentric compounds, the head of the compound and the compound itself share the same syntactic category (Punske 2016). Endocentric nominal compounds in English are right-headed; that is, the right element in an English endocentric nominal compound is a head N. On the other hand, the left/non-head element may be an A or another N. Generally speaking, an endocentric nominal compound is interpreted as a hyponym of the head N.

It is further noted in Punske (2016) that, in English, the interpretation of an endocentric nominal compound may be indicated by stress. For example, in a right-headed A-N compound such as *black bird*, if the stress falls on the head N, *bird*, then the compound would be interpreted as ‘a bird which is black’. Notably, it is also possible to regard *black bird* as a

nominal phrase where an AP *black* modifies an NP *bird*, in which case *black bird* would also be interpreted as ‘a bird which is black’. This suggests that English right-headed A-N compounds which have the same interpretation as the corresponding nominal phrases are interpreted compositionally; in particular, the non-head A serves as a restrictive modifier of the head N. By contrast, if the stress of *black bird* falls on the non-head A, *black*, then the right-headed A-N compound would be interpreted as a particular species of bird which is not necessarily black. This interpretation is unique to the compound. I suggest that English right-headed A-N compounds which do not have the same interpretation as the corresponding nominal phrases are interpreted idiosyncratically; in particular, I posit that the non-head A does not serve as a modifier of the head N. It is also possible that a right-headed A-N compound is not interpreted as a hyponym of the head N; for example, a *black sheep* may be interpreted as ‘a member of a family or group who is regarded as a disgrace to them’. I suggest that the compound is also interpreted idiosyncratically in this case.¹⁶

In addition, Jackson and Punske (2013) observe that an English endocentric nominal compound may be interpreted in various ways. For example, a right-headed N-N compound such as *swanboat* may be interpreted as ‘a boat which is made for swans’, ‘a boat which is made in the shape of a swan’, or ‘a boat which is made out of swans’. Notably, the first interpretation may also be obtained from the corresponding nominal phrase, *swan’s boat*, where an NP *swan* modifies the other NP *boat*. By contrast, the other interpretations are unique to the compound. I suggest that the interpretation of *swanboat* as ‘a boat which is made for swans’ is compositional, whereas the other interpretations of *swanboat* are idiosyncratic. Likewise, other English right-headed N-N compounds which are interpreted compositionally have the same interpretation as

¹⁶ I do not make a distinction between right-headed A-N compounds with idiosyncratic interpretation which are interpreted as a hyponym of the head N and those which are not. However, there is room for debate.

the corresponding nominal phrases; for example, *basketball player* may be interpreted as ‘basketball’s player’, *soccer field* may be interpreted as ‘soccer’s field’, and *baseball bat* may be interpreted as ‘baseball’s bat’. By contrast, English right-headed N-N compounds which are interpreted idiosyncratically do not have a corresponding nominal phrase; for example, *basketball* and *baseball* cannot be interpreted as ‘*basket’s ball’ and ‘*base’s ball’.¹⁷

To reiterate, both right-headed A-N compounds and right-headed N-N compounds in English exhibit a two-way split with respect to interpretation. I suggest that (cross-linguistically) right-headed X-N compounds which have the same interpretation as the corresponding nominal phrases are interpreted compositionally. By contrast, right-headed X-N compounds which do not have the same interpretation as the corresponding nominal phrases, or do not have a corresponding nominal compound, are interpreted idiosyncratically. In Section 2.2.2, I propose that, cross-linguistically, endocentric nominal compounds share the same D-structure; I further propose that the split among endocentric nominal compounds with respect to interpretation arises from different S-structures.

Endocentric nominal compounds in Mandarin are mostly right-headed. Right-headed A-N compounds in Mandarin will be studied in Section 2.2.3. Right-headed N-N compounds in Mandarin will be studied in Section 2.2.4.¹⁸ In addition, a handful of endocentric nominal compounds in Mandarin are left-headed. Left-headed N-X compounds in Mandarin will be studied in Section 2.2.5.

¹⁷ It is debatable whether *basketball’s player*, *soccer’s field*, and *baseball’s bat* are grammatical, but it seems that *basket’s ball* and *base’s ball* are much more degraded.

¹⁸ Right-headed V-N compounds in Mandarin will be studied in Section 4.1.4.

2.2.2 Compounding in Distributed Morphology

Harley (2009) suggests that a compound may be understood as a word-sized unit composed of two or more Roots. Therefore, the key to understanding right-headed X-N compounds is understanding how the Root which surfaces to the right of the compound is regarded as the head N of the compound, while the other Root is regarded as the non-head element, and how the Root which is regarded as the head of the compound and the compound itself are both categorized as an nP. It is also important to understand how a right-headed X-N compound may be interpreted compositionally or idiosyncratically.

In Harley (2009), it is proposed that right-headed N-N compounds, such as *nurse shoes* and *alligator shoes*, share the same morphological derivation with synthetic nominal compounds, which are composed of the internal argument of a V, the V, and a n°, e.g., *truck driver*. The D-structure of a right-headed X-N compound may be schematized as in (30a). Specifically, one of the two Roots is first merged with an x° whereby it is categorized as an xP. The other Root then merges with the xP and projects a √P. Finally, the √P merges with an n° whereby it is categorized as an nP.

Harley (2009) further proposes that incorporation takes place from the Root which is in the complement of the xP to the x° which heads the xP, in addition to successive x°-to-Root-to-n° head movement, as indicated in (30a). As a result, both Roots are embedded in the n° which heads the highest nP formed in the morphological derivation of the compound, as illustrated in (30b). I assume that incorporation or head movement into an x° is mandatory for each xP, whereas x°-to-Root head movement is optional and feature-driven (à la Harley 2009).

(30) a.

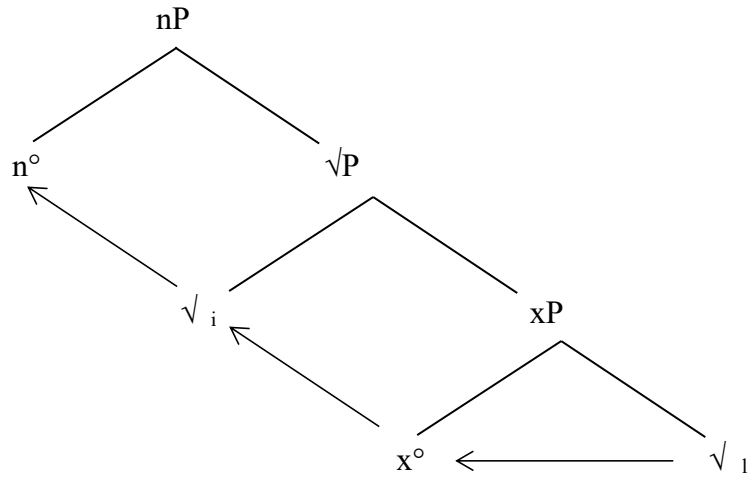

b.

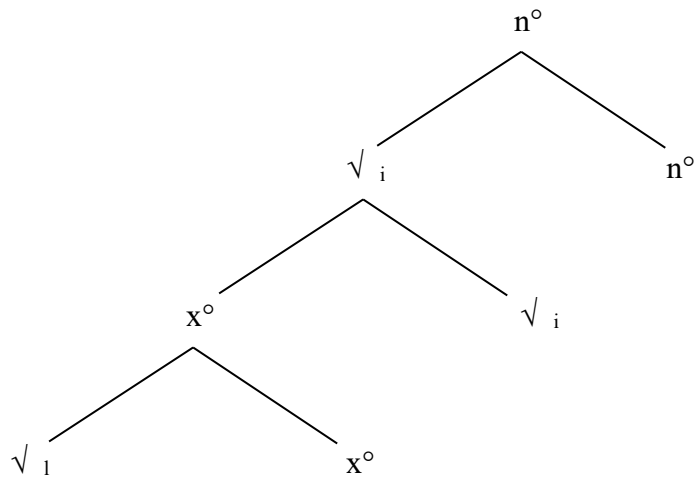

I propose that, cross-linguistically, endocentric nominal compounds share the D-structure in (26a). Because the highest nP in (26a) is formed when the \sqrt{P} which is headed by a Root is categorized by an n° , I suggest that the Root which heads the \sqrt{P} may be regarded as the head of the compound, and is also (indirectly) categorized as an nP. In this respect, the Root which is regarded as the head of the compound and the compound itself are both categorized as an nP. On the other hand, the other Root categorized as an xP may be regarded as the non-head element, because the xP is in the complement of the \sqrt{P} .

Notably, as a result of x° -to-Root head movement, the xP which is in the complement of the \sqrt{P} would not be embedded in the internal structure of the n° which heads the highest nP. Consequently, in (30b), the two Roots which are regarded as the head and non-head element of the endocentric nominal compound would be embedded in the same xP/domain for non-compositional interpretation, according to the single Spell-Out model of morpho-syntax; in other words, the two Roots may be interpreted idiosyncratically. In addition, because the Root which is regarded as the head of the compound surfaces to the right of the compound in (30b), the compound is right-headed. To this end, I suggest that, cross-linguistically, right-headed X-N compounds with idiosyncratic interpretation share the S-structure in (30b).

On the other hand, I posit that, cross-linguistically, right-headed X-N compounds with compositional interpretation have the S-structure in (31b), where pseudo-incorporation from the xP to the Root which heads the \sqrt{P} takes place as opposed to x° -to-Root head movement, as indicated in (31a). Because the xP which is in the complement of the \sqrt{P} would be embedded in the internal structure of the n° which heads the highest nP as a result of pseudo-incorporation, each of the two Roots would be embedded in a different xP/domain for non-compositional interpretation. According to the single Spell-Out model of morpho-syntax, the two Roots must be interpreted compositionally. In addition, because the Root which is regarded as the head of the compound surfaces to the right of the compound in (31b), the compound is right-headed.

(31) a.

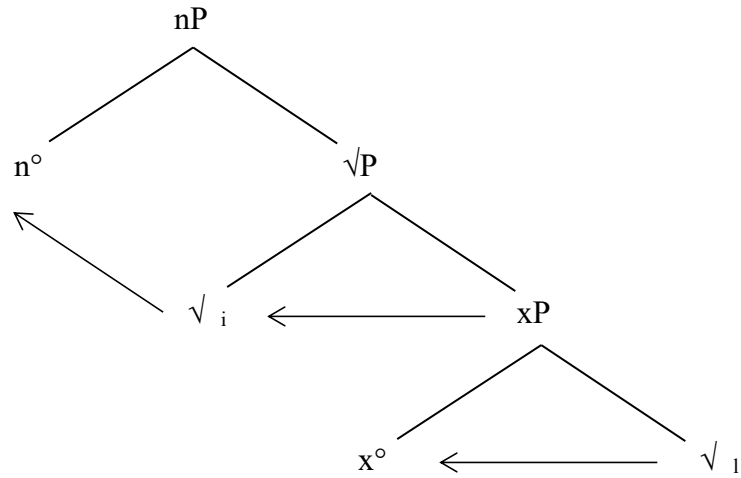

b.

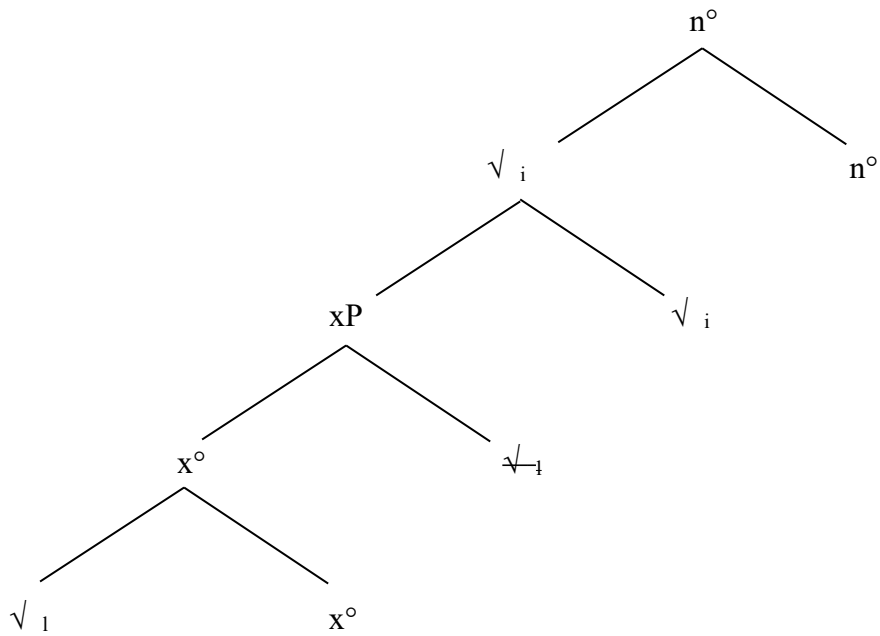

Last but not least, because only incorporation or head movement into an x° is mandatory for each xP, I suggest that it is also possible that neither x°-to-Root head movement nor xP-to-Root pseudo-incorporation takes place, as schematized in (32). As a result, only the Root which heads the √P/is regarded as the head of the compound is embedded in the n° which heads the highest nP. Therefore, I suggest that the Root which is regarded as the non-head element is interpreted as non-restrictive. Notably, because the Root which is regarded as the head of the

compound a-symmetrically c-commands the Root which is regarded as the non-head element, the compound is left-headed.

(32)

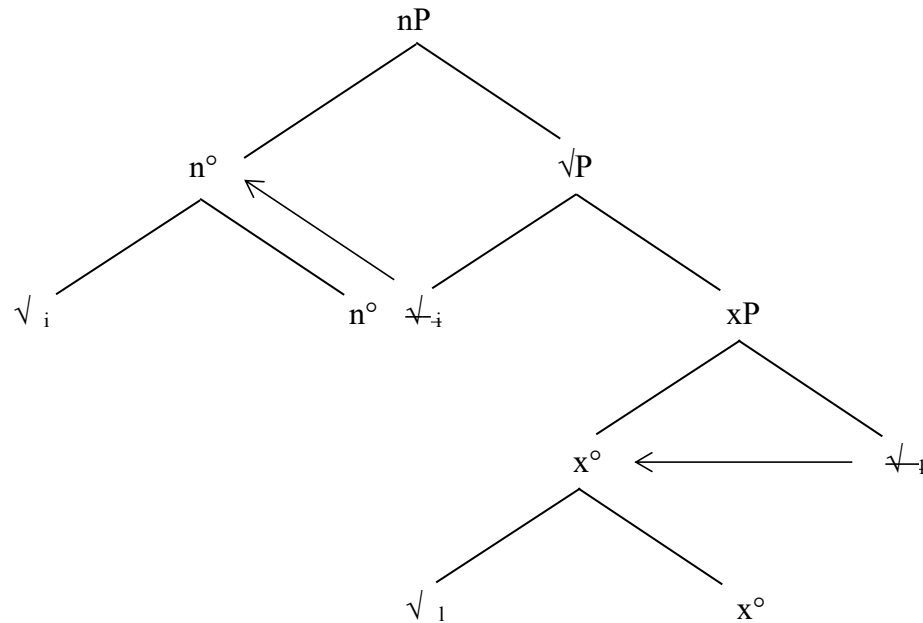

To reiterate, I have proposed that, cross-linguistically, endocentric nominal compounds have the same D-structure, while right-headed X-N compounds with compositional interpretation, right-headed X-N compounds with idiosyncratic interpretation, and left-headed N-X compounds have different S-structures. In Sections 2.2.3, 2.2.4, and 2.2.5, I will show that different types of endocentric nominal compounds in Mandarin may be accounted for by the D-structure and S-structures schematized in this section. Notably, I will argue that synthetic nominal compounds do not have the same D-structure or S-structure as endocentric nominal compounds in Section 3.2.2.

2.2.3 Right-headed A-N compounds

Right-headed A-N compounds in Mandarin also exhibit a two-way split with respect to interpretation, as exemplified in (33) and (34). Specifically, the compounds in (33a) and (33b) have the same interpretation as the corresponding nominal phrases, which are non-predicative *de*-constructions where an NP argument is modified by an AP modifier, as shown in (33a') and (33b'). By contrast, the compounds in (34a) and (34b) do not have the same interpretation as the corresponding non-predicative *de*-constructions which are shown in (34a') and (34b'). Therefore, I suggest that the interpretation of each compound in (33) is compositional; in particular, the non-head A serves as a restrictive modifier of the head N in (33). By contrast, I suggest that the interpretation of each compound in (34) is idiosyncratic; in particular, the non-head A does not serve as a restrictive modifier of the head N in (34).

- | | | | | |
|------|----|-----------------|-----|--------------------|
| (33) | a. | <i>lan tian</i> | a'. | <i>lan de tian</i> |
| | | blue sky | | blue sky |
| | | 'blue sky' | | 'blue sky' |
| | b. | <i>lao ren</i> | b'. | <i>lao de ren</i> |
| | | old person | | old person |
| | | 'old person' | | 'old person' |
| (34) | a. | <i>bai cai</i> | a'. | <i>bai de cai</i> |
| | | white vegetable | | white vegetable |
| | | 'cabbage' | | 'white vegetable' |
| | b. | <i>xiao ren</i> | b'. | <i>xiao de ren</i> |
| | | small person | | small person |
| | | 'flunky' | | 'small person' |

I propose that the two types of right-headed A-N compounds in Mandarin have the same D-structure but different S-structures. Because the interpretation of each compound in (33) is compositional, I suggest that compounds of this type have the D-structure and S-structure in (31a) and (31b). The D-structure and S-structure of (33a) are illustrated in (35a) and (35b). Specifically, the x° and the xP in (31a) and (31b) are specified as an a° and an aP in (35a) and (35b), and the Roots are specified with the glosses in (33a). I assume that the VIs *lan* and *tian* are specified for $\sqrt{\text{blue}}$ and $\sqrt{\text{sky}}$, respectively; thereby, *lan* is inserted to $\sqrt{\text{blue}}$, and *tian* is inserted to $\sqrt{\text{sky}}$ ¹⁹. I also assume that the x° by which each Root is categorized is fused into the Root as a result of incorporation or head movement; consequently, neither x° is subject to Vocabulary Insertion.

(35) a.

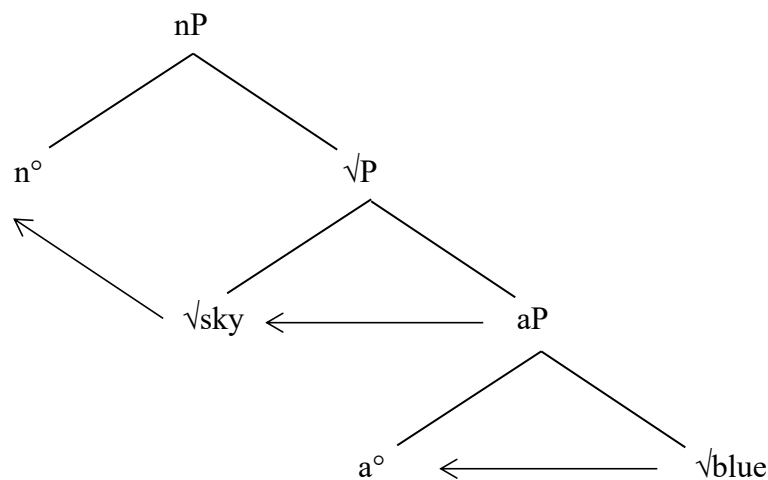

¹⁹ Because Vocabulary Insertion takes place post-syntactically, the VIs are specified only in the S-structure. The same holds for all the subsequent figures.

b.

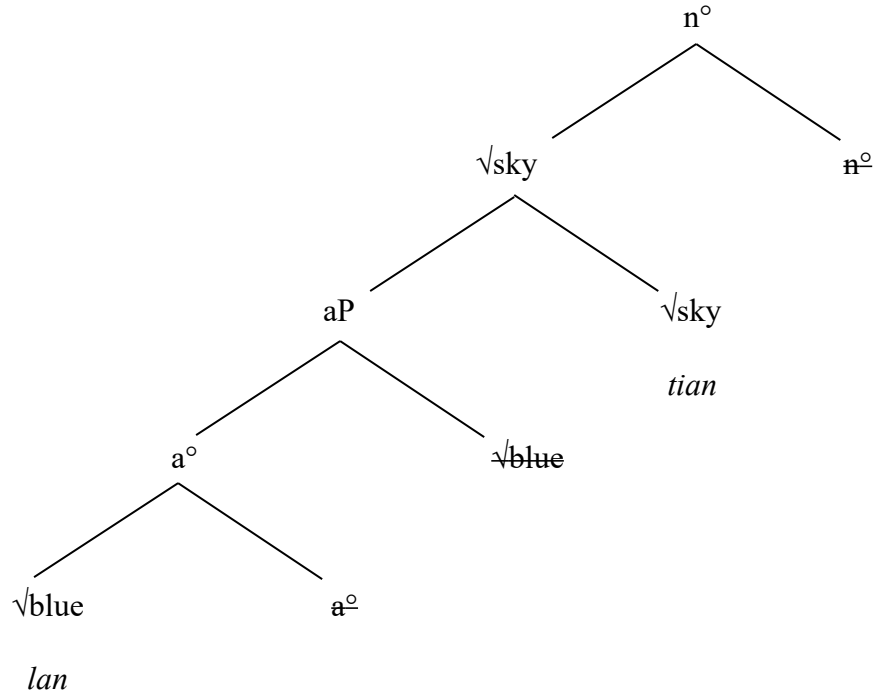

On the other hand, because the interpretation of each compound in (34) is idiosyncratic, I suggest that compounds of this type have the D-structure and S-structure in (30a) and (30b). The D-structure and S-structure of (34a) are illustrated in (36a) and (36b). As before, the x° and the xP in (30a) and (30b) are specified as an a° and an aP in (36a) and (36b), and the Roots are specified with the glosses in (34a). I assume that the VIs *bai* and *cai* are specified for $\sqrt{\text{white}}$ and $\sqrt{\text{vegetable}}$, respectively; thereby, *bai* is inserted to $\sqrt{\text{white}}$, and *cai* is inserted to $\sqrt{\text{vegetable}}$. I also assume that the x° by which each Root is categorized is fused into the Root; consequently, neither x° is subject to Vocabulary Insertion.

(36) a.

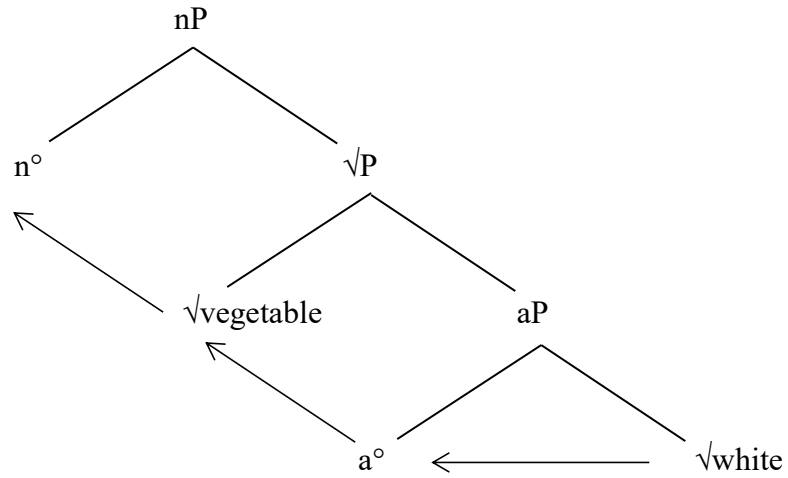

b.

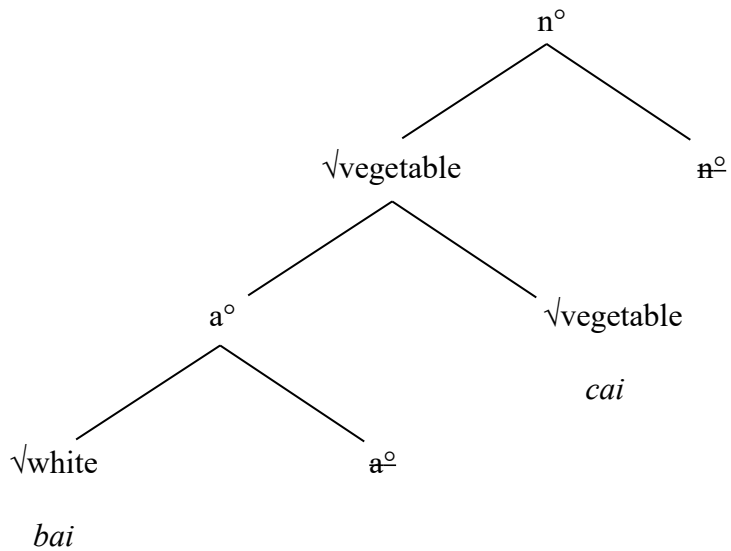

2.2.4 Right-headed N-N compounds

Right-headed N-N compounds in Mandarin also exhibit a two-way split, as exemplified in (37) and (38). Specifically, the compounds in (37a) and (37b) may be reconstructed as non-predicative *de*-constructions where an NP argument is modified by an NP modifier, as shown in (37a') and (37b'), where both NPs in each reconstructed non-predicative *de*-construction are endocentric nominal compounds the head of which corresponds to the non-head N or the head N

in the compounds in (37a) and (37b)²⁰. Therefore, I suggest that the interpretation of each compound in (37) is compositional; in particular, the non-head N serves as a restrictive modifier of the head N in (37). By contrast, the compounds in (34a) and (34b) cannot be reconstructed as non-predicative *de*-constructions, as evidenced by the ungrammaticality of (38a') and (38b'). Therefore, I suggest that the interpretation of each compound in (38) is idiosyncratic; in particular, the non-head N does not serve as a restrictive modifier of the head N in (38).

(37)	a.	<i>qiu chang</i>		a'.	<i>bang qiu de qiu chang</i>
		ball field			bat ball ball field
		'stadium'			'baseball's stadium'
	b.	<i>yang nai</i>		b'.	<i>yang de nai</i>
		sheep milk			sheep milk
		'sheep milk'			'sheep's milk'
(38)	a.	<i>bang qiu</i>		a'.	* <i>qiu bang de bang qiu</i>
		bat ball			ball bat bat ball
		'baseball'			Intended: 'bat's baseball'
	b.	<i>nai niu</i>		b'.	* <i>nai de niu</i>
		milk cattle			milk cattle
		'cow'			Intended: 'milk's cattle'

Likewise, I propose that the two types of right-headed N-N compounds in Mandarin have the same D-structure but different S-structures. Because the interpretation of each compound in (37) is compositional, I suggest that compounds of this type have the D-structure and S-structure in (31a) and (31b). The D-structure and S-structure of (37a) are illustrated in

²⁰ The nominal phrases are reconstructed in such a way because the *de* particle cannot be directly inserted between the non-head N and the head N of the right-headed N-N compound.

(39a) and (39b). Specifically, the x° and the xP in (31a) and (31b) are specified as an n° and an nP in (39a) and (39b), and the Roots are specified with the glosses in (37a). I assume that the VIs *qiu* and *chang* are specified for $\sqrt{\text{ball}}$ and $\sqrt{\text{field}}$, respectively; thereby, *qiu* is inserted to $\sqrt{\text{ball}}$, and *chang* is inserted to $\sqrt{\text{field}}$. I also assume that the x° by which each Root is categorized is fused into the Root; consequently, neither x° is subject to Vocabulary Insertion.

(39) a.

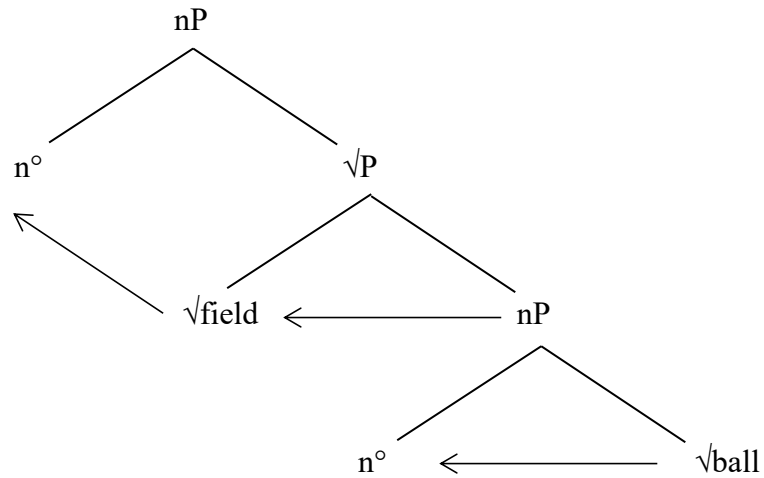

b.

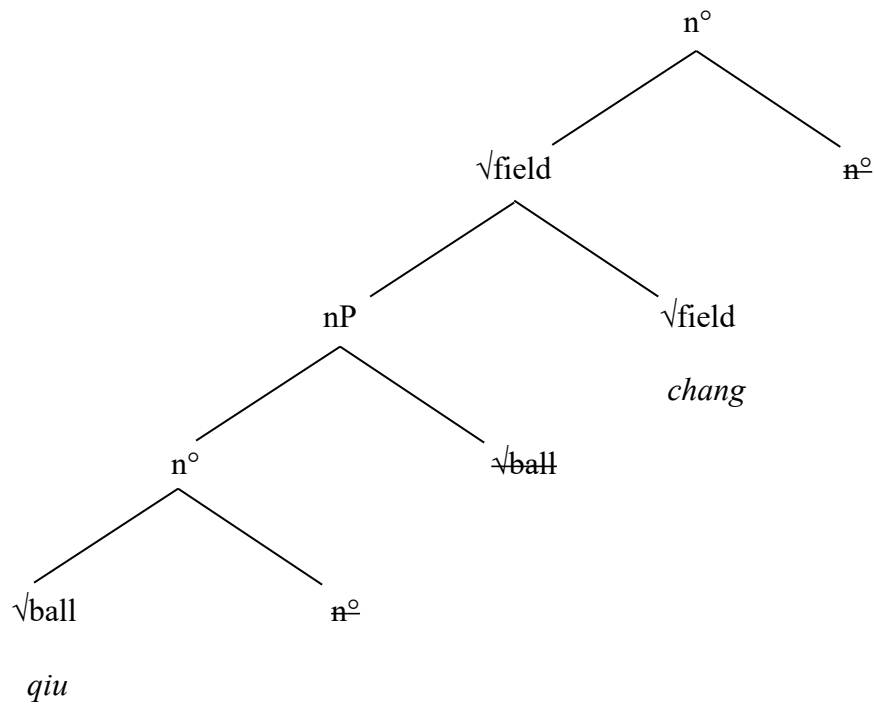

On the other hand, because the interpretation of each compound in (38) is idiosyncratic, I suggest that compounds of this type have the D-structure and S-structure in (30a) and (30b). The D-structure and S-structure of (38a) are illustrated in (40a) and (40b). Likewise, the x° and the xP in (30a) and (30b) are specified as an n° and an nP in (40a) and (40b), and the Roots are specified with the glosses in (38a). I assume that the VIs *bang* and *qiu* are specified for $\sqrt{\text{bat}}$ and $\sqrt{\text{ball}}$ respectively, and the x° by which each Root is categorized is fused into the Root; consequently, neither x° is subject to Vocabulary Insertion.

(40) a.

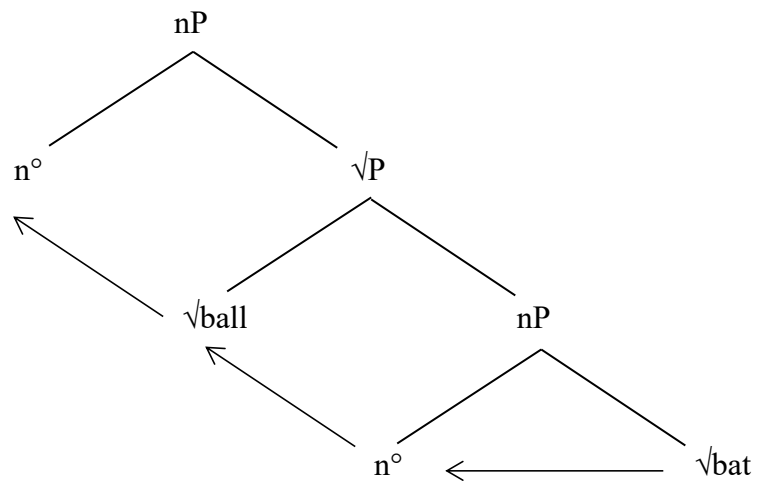

b.

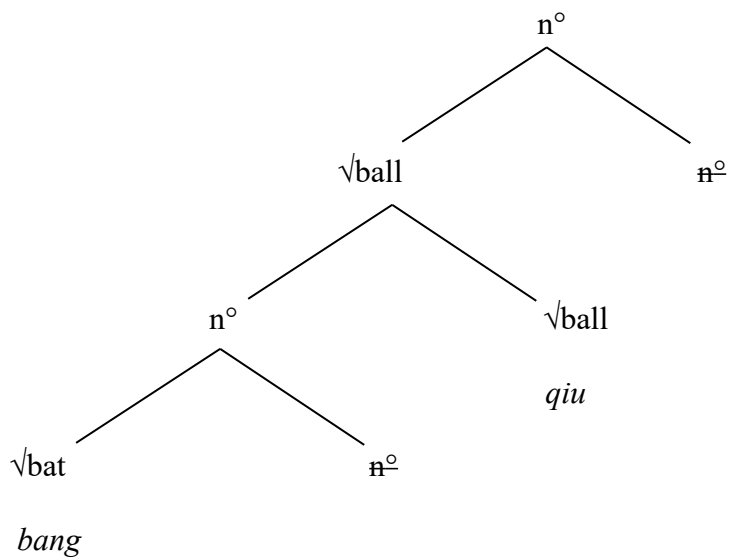

In addition, I suggest that a right-headed N-N compound may form another right-headed N-N compound with a Root or another right-headed N-N compound,²¹ as shown in (41a) and (41b).

- | | | | | | | | |
|------|----|--------------------|--------------|--|----|--------------------|------------------|
| (41) | a. | <i>bang-qiu</i> | <i>chang</i> | | b. | <i>bang-qiu</i> | <i>qiu-chang</i> |
| | | baseball | field | | | baseball | stadium |
| | | ‘baseball stadium’ | | | | ‘baseball stadium’ | |

I propose that the compounds in (41) are formed when the right-headed N-N compound in (38a), the morphological derivation of which has been illustrated in (40), reenters the Numeration as a Root, thereby the Root may be selected in the morphological derivation which has been illustrated in (39).²² In the morphological derivation of (41b), the right-headed N-N compound in (37a), the morphological derivation of which has been illustrated in (39), also reenters the Numeration as a Root, thereby this Root may also be selected in the morphological derivation which has been illustrated in (39).²³

2.2.5 Left-headed N-X compounds

Finally, left-headed N-X compounds in Mandarin are exemplified in (42). I suggest that the non-head element in each compound, whether an A (42a), a N (42b), or a V (42c), is interpreted as non-restrictive, because the compound has the same interpretation as the head of the compound, as shown in (42a’), (42b’), and (42c’).

²¹ Generally speaking, it is expected that an endocentric nominal compound can form another endocentric nominal compound with a Root or another endocentric nominal compound, a line of inquiry I will leave to future research.

²² This Root would be in the position of $\sqrt{\text{ball}}$ in (39).

²³ This Root would be in the position of $\sqrt{\text{field}}$ in (39).

- (42) a. *yue liang*
moon bright
‘moon’ *cf.* ‘bright moon’
- a’. *yue*²⁴
moon
‘moon’
- b. *chuang hu*
window house
‘window’ *cf.* ‘house’s window’
- b’. *chuang*
window
‘window’
- c. *he liu*
river flow
‘river’ *cf.* ‘flowing river’
- c’. *he*
river
‘river’

Another piece of evidence is that a non-predicative *de*-construction where the NP argument is a left-headed N-X compound, such as (42a), (42b), or (42c), may be modified by an XP which semantically contradicts the non-head element of the compound, as shown in (43a), (43b), and (43c). In contrast, a non-predicative *de*-construction where the NP argument is a right-headed X-N compound with a compositional interpretation, such as (33a) and (41a), is ungrammatical if the XP modifier and the non-head element of the compound are semantically contradictory, as shown in (43a’) and (43b’).

- (43) a. *hun-an de yue liang*
dim moon bright
‘dim moon’
- a’ **hui de lan tian*
gray blue sky
Intended: ‘gray blue sky’

²⁴ It is debatable whether *yue* can be used as a free morpheme.

- b. *che* *de* *chuang* *hu*
 vehicle window house
 ‘vehicle’s window’
- b’. **lan-qiu* *de* *bang-qiu* *chang*
 basketball baseball field
 Intended: ‘basketball’s baseball stadium’
- c. *jing-zhi* *de* *he* *liu*
 still river flow
 ‘still river’

I propose that the left-headed N-X endocentric nominal compounds in Mandarin have the same D-structure in (32). Specifically, the x° and the xP are specified as an a° and an aP for (42a), as an n° and an nP for (42b), and as a v° and a vP for (42c). The D-structure and S-structure of (42a) are illustrated in (44). The Roots are specified with the glosses in (42a). I assume that the VIs *yue* and *liang* are specified for $\sqrt{\text{moon}}$ and $\sqrt{\text{bright}}$, respectively; thereby, *yue* is inserted to $\sqrt{\text{moon}}$ and *liang* is inserted to $\sqrt{\text{bright}}$. I also assume that the x° by which each Root is categorized is fused into the Root; consequently, neither x° is subject to Vocabulary Insertion.

(44)

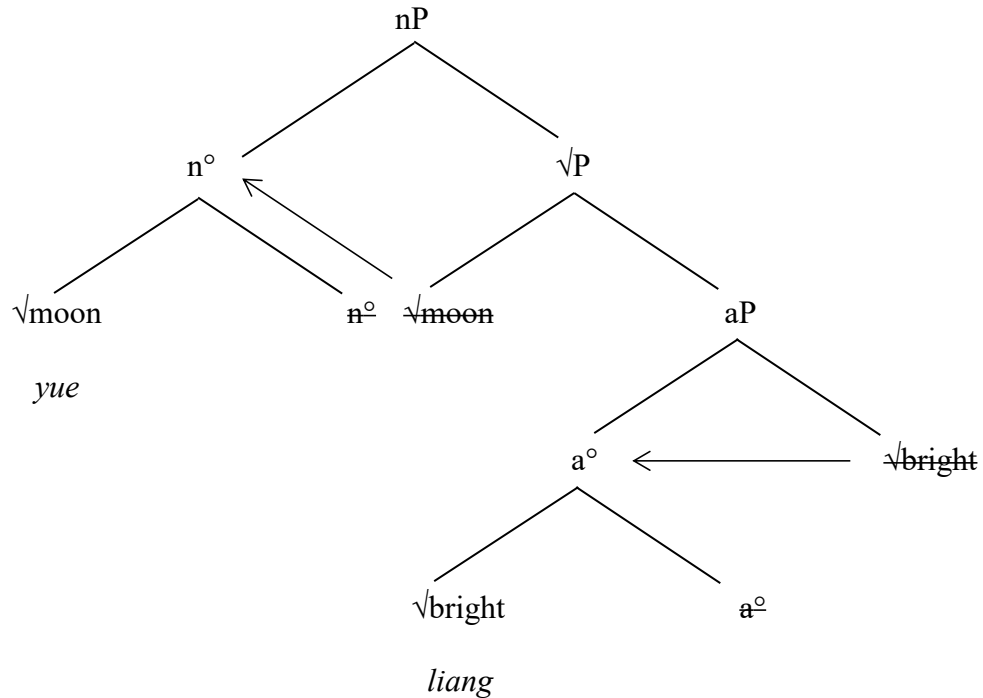

2.3 Interim summary

2.3.1 A note on Renumeration

Because the single Spell-Out model of morpho-syntax postulates that morphological derivation and syntactic derivation share one Numeration, and morphological derivations proceed to syntactic derivations via Renumeration, I suggest that the highest nP which is formed in the morphological derivation of each type of endocentric nominal compounds may reenter the Numeration as an NP, such that the NP may be selected in the syntactic derivation of a non-predicative *de*-construction.²⁵ Evidently, the NP argument in the non-predicative *de*-construction in (15a), the syntactic derivation of which has been illustrated in (25), is a left-headed N-A compound (42a), the morphological derivation of which has been illustrated in (44). Notably,

²⁵ In addition, the AP modifier in (25) must also be the highest aP which is formed in some morphological derivation, which then reenters the Numeration as an AP, thereby the AP may be selected in the syntactic derivation in (25). I will leave a detailed analysis to future research.

the nP is no longer a part of the (morpho-syntactic) derivation once it has reentered the Numeration as an NP, as shown in (45). The derivation in (45) is also outlined in (46).

(45)

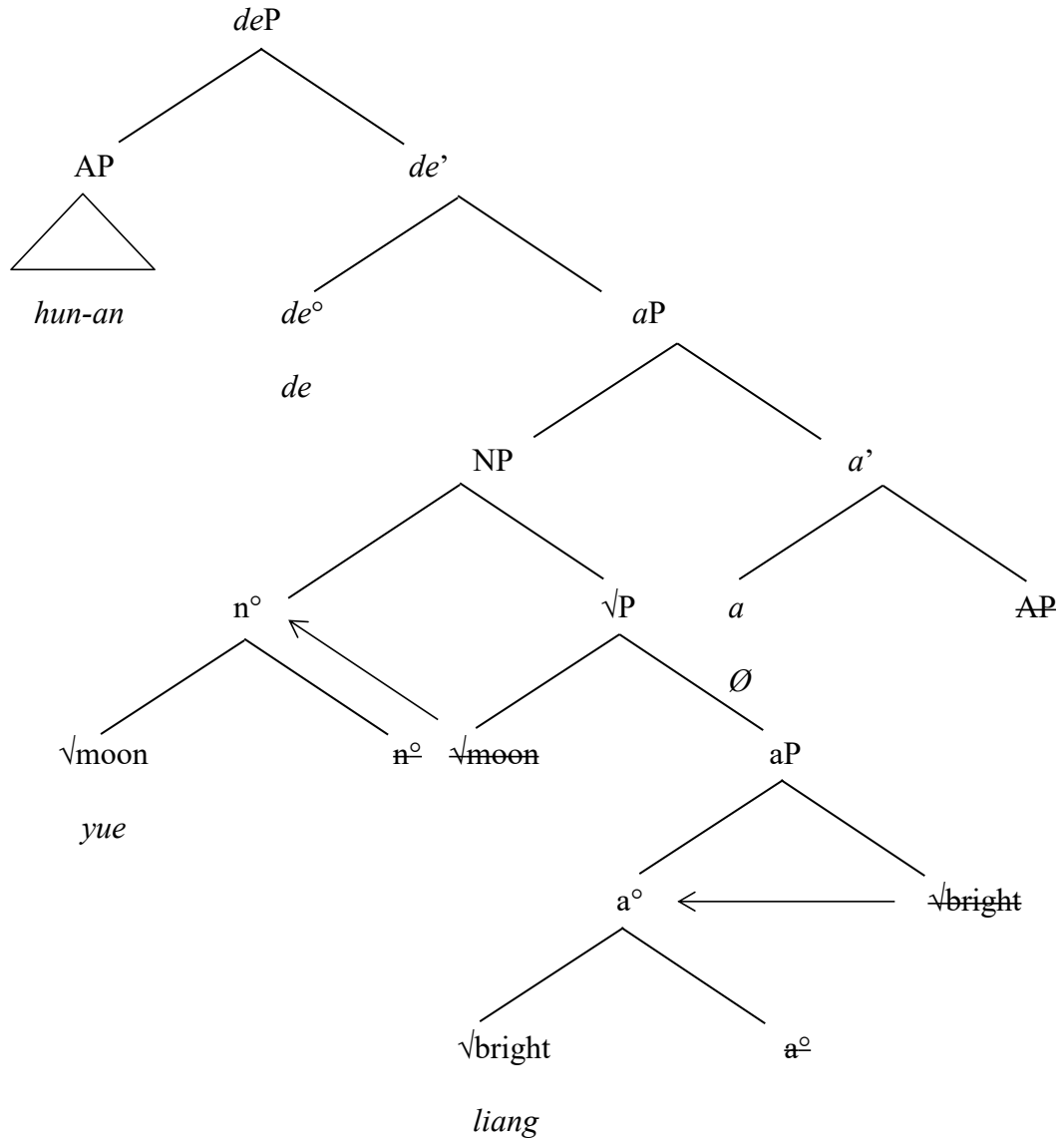

(46) Numeration = {AP,²⁶ *a*, *de*, *a*[°], √*bright*, *n*[°], √*moon*}

Morphological derivation (44)

Renumeration = {AP, *a*, *de*, NP}

Syntactic derivation (25)

²⁶ The AP is regarded as an unanalyzed unit.

In addition, as has been proposed in Section 2.2.4, the highest nP formed in the morphological derivation of a right-headed N-N compound, such as (41a) or (41b), may reenter the Numeration as a Root, thereby the Root may be selected in the morphological derivation of another right-headed N-N compound.

2.3.2 A note on LF

To summarize, I have shown that the interpretation of a non-predicative *de*-construction where an NP argument is modified by an XP modifier, such as (15a), is based on the internal structure, i.e. the specifier AP, the head *de*^o, and the complement *a*P of the *de*P in (25); because the AP and the *de*' are composed by means of modification, the AP is interpreted as a restrictive modifier. On the other hand, I have also shown that the interpretation of an endocentric nominal compound, such as the left-headed N-A compound in (42a), is based on the internal structure of the n^o which heads the highest nP formed in the morphological derivation of the compound; therefore, it follows that the Root (which is regarded as the non-head element), which is not embedded in the n^o, is interpreted as non-restrictive. In addition, because the first xP in which each Root is embedded is regarded as the domain for non-compositional interpretation according to the single Spell-Out model of morpho-syntax, right-headed X-N compounds which have the S-structure in (31b), such as the right-headed A-N compound in (33a), the S-structure of which has been illustrated in (35b), and the right-headed N-N compound in (37a), the S-structure of which has been illustrated in (39b), are interpreted compositionally, because each of the two Roots is embedded in a different xP/domain for non-compositional interpretation (as a result of pseudo-incorporation). By contrast, right-headed X-N compounds with the S-structure in (30b), such as the right-headed A-N compound in (34a), the S-structure of which has been illustrated in

(36b), and the right-headed N-N compound in (38a), the S-structure of which has been illustrated in (40b), are interpreted idiosyncratically, because the two Roots are embedded in the same xP/domain for non-compositional interpretation (as a result of head movement). To this end, it is suggested that, despite the mismatch between a syntactic representation (nominal phrase) and a morphological representation (nominal compound) with respect to LF interpretation, morphological derivation and syntactic derivation may share one single Spell-Out.

2.3.3 A note on PF

Because the single Spell-Out model of morpho-syntax postulates that morphological derivation and syntactic derivation share one single Spell-Out, I suggest that Vocabulary Insertion does not take place until after the syntactic derivations which proceed from the preceding morphological derivations have also terminated. For example, in the morpho-syntactic derivation illustrated in (45), Vocabulary Insertion does not take place when the morphological derivation (44) terminates, but when the syntactic derivation (25) has also terminated.

I have assumed that, in non-predicative *de*-constructions, the x which heads an extended projection of the XP is realized with a phonologically null VI. On the other hand, I have assumed that, in endocentric nominal compounds, the x° by which each Root is categorized is also fused into the Root; consequently, neither x° is subject to Vocabulary Insertion. While it might also be plausible to assume that the x° in endocentric nominal compounds is realized with a phonologically null VI, I will show that Fusion is a frequently used morphological operation by which certain terminal nodes of a morphological representation may be eliminated from Vocabulary Insertion in Section 3.2.3.

2.3.4 Similarities between morphological and syntactic derivations

Finally, it should be noted that the morphological derivation of endocentric nominal compounds and the syntactic derivation of non-predicative *de*-constructions are similar with respect to both D-structure and S-structure. I suggest that the similarities may have consequences for the nature of modification and its relation to argument structure.

With respect to D-structure, in the morphological derivation of endocentric nominal compounds (30a), the Root which is categorized as an xP is merged with an x° which heads the xP and is asymmetrically c-commanded by the other Root which heads the \sqrt{P} that is categorized as an nP . Similarly, in the syntactic derivation of non-predicative *de*-constructions (18), the XP is merged with an x which heads an xP and is asymmetrically c-commanded by the NP argument.

With respect to S-structure, in the morphological derivation of right-headed X-N compounds (30b) and (31b), the inversion of the two Roots takes place whereby the Root which is regarded as the head of the compound surfaces to the right of the Root which is regarded as the non-head element. Similarly, in the syntactic derivation of non-predicative *de*-constructions (24), the inversion of the XP modifier and the NP argument also takes place whereby the NP argument is linearized to the right of the XP modifier.

Chapter 3 The syntax of generic *de*-constructions and the morphology of synthetic nominal compounds

In this chapter, I will examine the compositionality of the nominalizer *de*^o and the VP in generic *de*-constructions, as well as the relationship among the V, its internal argument, and the n^o in synthetic nominal compounds in Mandarin. The syntactic derivation of generic *de*-constructions reveals that the *de*^o does not nominalize the VP directly, but rather, it nominalizes a *v*P (an extended projection of the VP). In addition, the *de*^o is proposed to be Agent-flavored, such that a generic *de*-construction may be interpreted as an Agent of the VP within it. The morphological derivation of synthetic nominal compounds reveals that, in the D-structure, the *v*P in which the Roots which are regarded as the V and its internal argument are embedded is verbalized prior to nominalization, while in the S-structure, the inversion of the two Roots may or may not take place whereby the compound may be interpreted compositionally. The n^o is also proposed to be Agent-flavored, such that a synthetic nominal compound may also be interpreted as an Agent of the V within it. I suggest that the similarities between the morphological derivation of synthetic nominal compounds and the syntactic derivation of generic *de*-constructions may have consequences for the nature of nominalization and its relation to argument structure.

3.1 Generic *de*-constructions in Mandarin

3.1.1 Introduction

As noted in Section 2.1.5, the *de*^o which is realized with the *de* particle may also serve as a nominalizer in nominal phrases which are derived from VPs. The use of the *de*^o as a

nominalizer is exemplified in (47) and (48). In all cases, the *de* particle surfaces to the right of the VP, and the nominal phrase is interpreted as an Agent of the VP it contains.

- | | | | | | | | |
|------|----|-----------------|------------------|-----------|-----|------------------|------------------|
| (47) | a. | <i>sheng</i> | <i>qi</i> | <i>de</i> | a'. | <i>sheng</i> | <i>qi</i> |
| | | raise | flag | | | raise | flag |
| | | 'flag raiser' | | | | 'raise flags' | |
| | b. | <i>chang</i> | <i>ge</i> | <i>de</i> | b'. | <i>chang</i> | <i>ge</i> |
| | | sing | song | | | sing | song |
| | | 'singer' | | | | 'sing songs' | |
| (48) | a. | <i>kai</i> | <i>che</i> | <i>de</i> | a'. | <i>kai</i> | <i>che</i> |
| | | drive | vehicle | | | drive | vehicle |
| | | 'driver' | | | | 'drive vehicles' | |
| | b. | <i>guan-li</i> | <i>cheng-shi</i> | <i>de</i> | b'. | <i>guan-li</i> | <i>cheng-shi</i> |
| | | govern | city | | | govern | city |
| | | 'city governor' | | | | 'govern cities' | |
| | c. | <i>xie</i> | <i>wen-zhang</i> | <i>de</i> | c'. | <i>xie</i> | <i>wen-zhang</i> |
| | | write | article | | | write | article |
| | | 'writer' | | | | 'write articles' | |
| | d. | <i>da</i> | <i>qiu</i> | <i>de</i> | d'. | <i>da</i> | <i>qiu</i> |
| | | hit | ball | | | hit | ball |
| | | 'ball player' | | | | 'play balls' | |

In addition, the internal argument of the V in each nominal phrase in (48)²⁷ can be further specified, as exemplified in (49).

²⁷ The nominal phrases in (47) exhibit the same pattern.

- (49) a. *kai ka-che de*
drive truck
‘truck driver’
- b. *guan-li bei-jing de*
govern Beijing
‘governor of Beijing’
- c. *xie ke-huan-xiao-shuo de*
write fiction
‘fiction writer’
- d. *da bang-qiu de*
hit baseball
‘baseball player’

Moreover, the nominal phrases in (48)²⁸ may be construed as generics with the same VP, as shown in (50). In this respect, nominal phrases which surface as VP *de* will be referred to as generic *de*-constructions.

- (50) a. *kai che de kai che*
drive vehicle drive vehicle
‘Drivers drive vehicles.’
- b. *guan-li cheng-shi de guan-li cheng-shi*
govern city govern city
‘City governors govern cities.’

²⁸ The nominal phrases in (47) exhibit the same pattern.

c. *xie wen-zhang de xie wen-zhang*
 write article write article

‘Writers write articles.’

d. *da qiu de da qiu*
 hit ball hit ball

‘Ball players play balls.’

Last but not least, it should be noted that every generic *de*-construction may be reconstructed as a non-predicative *de*-construction where an NP argument is modified by a VP modifier, as shown in (51).

(51) a. *kai che de ren*
 drive vehicle person

‘vehicle-driving person’

b. *guan-li cheng-shi de ren*
 govern city person

‘city-governing person’

c. *xie wen-zhang de ren*
 write article person

‘article-writing person’

d. *da qiu de ren*
 hit ball person

‘ball-playing person’

In Section 3.1.2, the (morpho-)syntactic derivation of generic *de*-constructions will be proposed based on compositionality; specifically, it will be proposed that generic *de*-

constructions are formed when the de° nominalizes an extended projection of the VP, and the VP raises to the specifier of the deP to serve as a modifier. In Section 3.1.3, it will be argued that generic de -constructions must be structurally different from non-predicative de -constructions.

3.1.2 Compositionality

I propose that, in the D-structure of generic de -constructions, the de° nominalizes a νP , which is an extended projection of the VP. Specifically, because the XP in non-predicative de -constructions has been proposed to be of type $\langle e \rangle$, I suggest that the VP in generic de -constructions should also be analyzed as being of type $\langle e \rangle$.²⁹ Notably, because the de° is a “down” operator, i.e., of type $\langle \langle e, t \rangle, e \rangle$, the VP cannot be composed with the de° directly. However, because it has been proposed that the xP in non-predicative de -constructions, which is an extended projection of the XP, is of type $\langle e, t \rangle$, I suggest that the extended projection of the VP in generic de -constructions, which is a νP , should also be analyzed as being of type $\langle e, t \rangle$. To this end, I suggest that, in generic de -constructions, the VP is base-generated in the complement of a νP , and the νP is base-generated in the complement of the deP . In addition, I posit that the nominalizer de° in generic de -constructions is specified with an [Agent] feature, or is Agent-flavored³⁰ (Harley 2009), thereby generic de -constructions may be interpreted as an Agent of the VP within them. The D-structure of the generic de -construction in (48a) is illustrated in (52). Because the x which heads the xP in non-predicative de -constructions is proposed to be realized with a phonologically null VI, I propose that the ν which heads the νP in generic de -constructions is also realized with a phonologically null VI.

²⁹ As noted in Section 2.1.5, it seems problematic to analyze a VP as being of type $\langle e \rangle$. Future research is necessary to fix this problem.

³⁰ Theme-flavoured de° will be proposed in Section 4.1.2.

Notably, because it has been proposed that syntactic derivations proceed from morphological derivations, the V and the NP in generic *de*-constructions must have been the highest vP and nP formed in two different morphological derivations. I assume that the VIs *kai* and *che* realize $\sqrt{\text{drive}}$ and $\sqrt{\text{vehicle}}$ which are categorized as a vP and an nP in two different morphological derivations.³¹ The vP and the nP then reenter the Numeration as a V and an NP (the internal argument of the V), thereby the V and the NP may be selected in the syntactic derivation. Notably, the vP and the nP no longer play a part in the morpho-syntactic derivation in (52); on the other hand, the V and the NP may be regarded as syntactic terminal nodes.

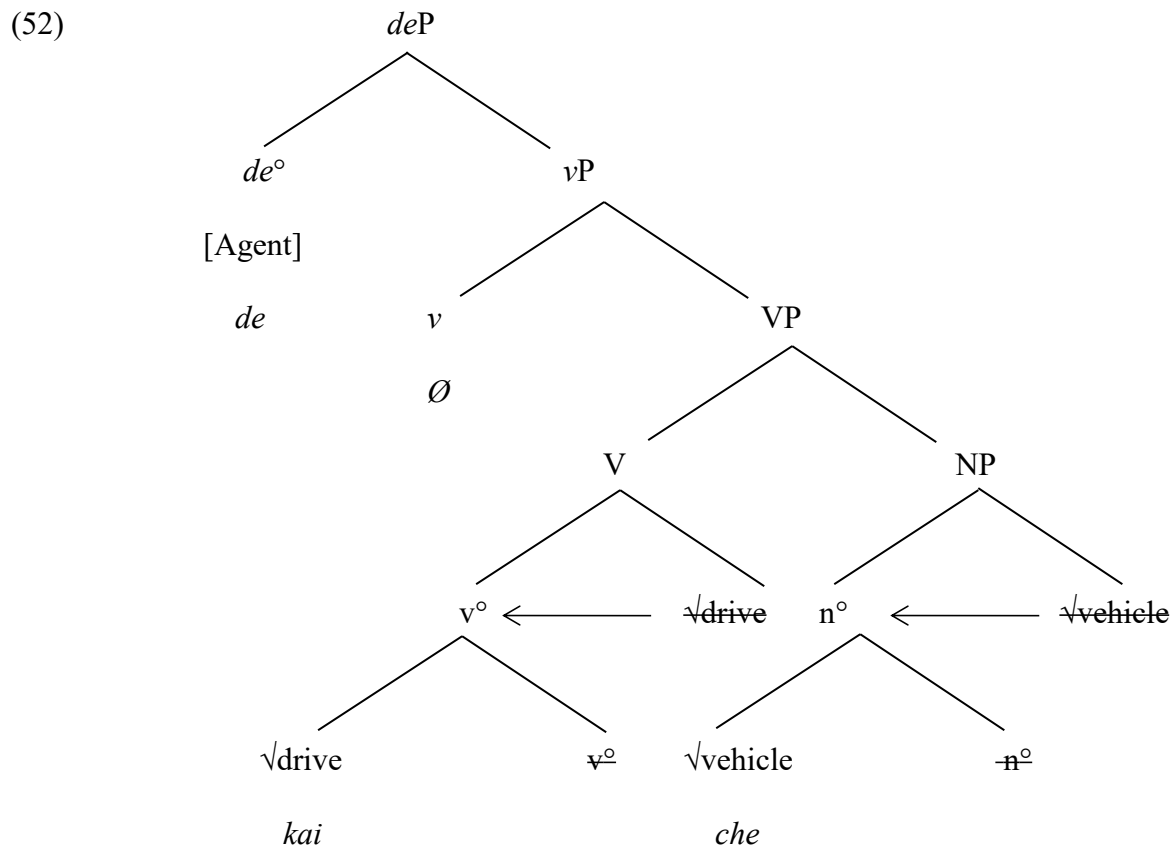

³¹ Because it is assumed that incorporation or head movement into an x° is mandatory for each xP, I propose that $\sqrt{\text{drive}}$ and $\sqrt{\text{vehicle}}$ incorporate into the v° and the n° , respectively. I also assume that the v° and the n° are fused into $\sqrt{\text{drive}}$ and $\sqrt{\text{vehicle}}$, such that neither x° is subject to Vocabulary Insertion.

Because it has been proposed that, in the S-structure of non-predicative *de*-constructions, the XP raises to the specifier of the *de*P whereby it may be interpreted as a restrictive modifier, I further propose that, in the S-structure of generic *de*-constructions, the VP also raises to the specifier of the *de*P and is composed with the *de*' by means of modification, which accounts for the observation that every generic *de*-construction may be reconstructed as a non-predicative *de*-construction (51). Notably, because the *de*P is of type <e> (as a result of modification), generic *de*-constructions may further serve as an argument, as evidenced by (50). The S-structure of the generic *de*-construction in (48a) is illustrated in (53).

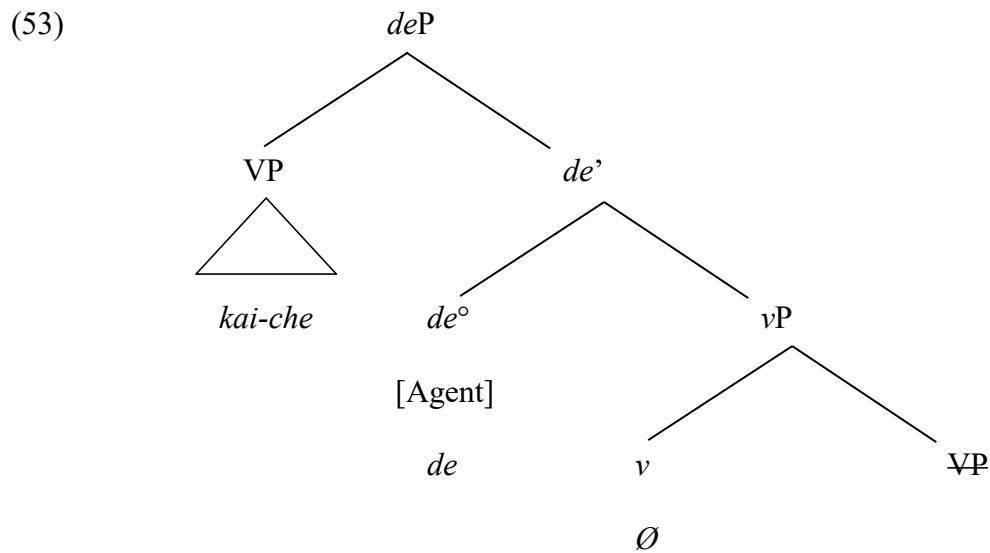

3.1.3 Discussion

Alternatively, it also seems plausible to analyze generic *de*-constructions as a subtype of non-predicative *de*-constructions where a phonologically null pronominal NP (PRO) is modified by a VP modifier, under which analysis the syntactic derivation of (48a) would then be that illustrated in (54). However, I argue that generic *de*-constructions must be structurally different from non-predicative *de*-constructions. Specifically, I suggest that there cannot be an NP

argument in generic *de*-constructions, which may be drawn from the observation that generic *de*-constructions are non-recursive,³² as shown in (55a), (55b), (55c) and (55d), whereas the corresponding non-predicative *de*-constructions are recursive, as shown in (55a'), (55b'), (55c') and (55d').

(54)

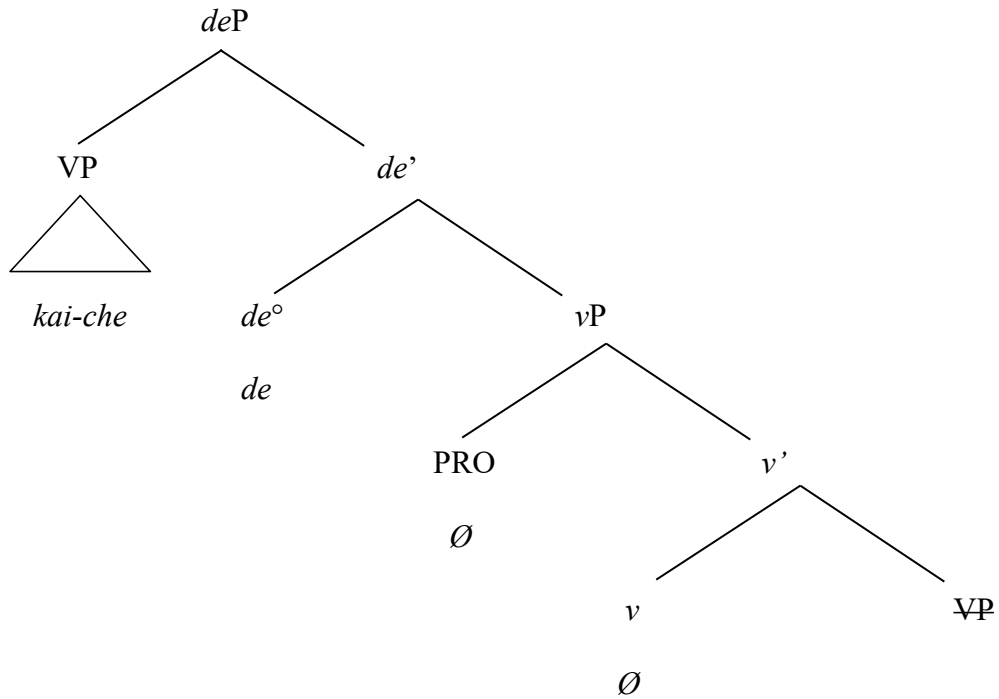

(55) a. **da bang-qiu de, kai che de*
 hit baseball drive vehicle

Intended: 'baseball player and driver'

a'. *da bang-qiu (de), kai che de ren*
 hit baseball drive vehicle person

'baseball-playing and vehicle-driving person'

³² Grammaticality judgements may differ among native speakers of Mandarin. However, it seems that (55a), (55b), (55c) and (55d) are much more degraded than (55a'), (55b'), (55c') and (55d').

- b. **xie ke-huan-xiao-shuo de, guan-li cheng-shi de*
 write fiction govern city
 Intended: ‘fiction writer and city governor’
- b’. *xie ke-huan-xiao-shuo (de), guan-li cheng-shi de ren*
 write fiction govern city person
 ‘fiction-writing and city-governing person’
- c. **guan-li bei-jing de, xie wen-zhang de*
 govern Beijing write article
 Intended: ‘governor of Beijing and writer’
- c’. *guan-li bei-jing (de), xie wen-zhang de ren*
 govern Beijing write article person
 ‘Beijing-governing and article-writing person’
- d. **kai ka-che de, da qiu de*
 drive vehicle hit ball
 Intended: ‘truck-driver and ball player’
- d’. *kai ka-che (de), da qiu de ren*
 drive vehicle hit ball person
 ‘truck-driving and ball-playing person’

Recall that, in cases where an NP argument may be modified by various XPs, the *de*P composed from the NP argument and the most embedded XP modifier may further be merged in the specifier of another *x*P which is an extended projection of a less embedded XP modifier of the NP argument, thereby the *de*P may be assigned a corresponding theta role by the *x* in another non-predicative *de*-construction. Along these lines, I propose that the embedded *de*P in (55a’),

(55b'), (55c') and (55d') is merged in the specifier of another *v*P which is an extended projection of the VP modifier within the matrix *de*P, thereby the embedded *de*P may be assigned an Agent role by the *v*. Crucially, because there is an NP argument within the embedded *de*P which is assigned an Agent role by the *v* in the embedded *de*P, the embedded *de*P itself is free to be assigned an Agent role by the *v* in the matrix *de*P.

On the other hand, I suggest that the ungrammaticality of (55a), (55b), (55c) and (55d) is because the Agent role of a generic *de*-construction is inherent in the *de*^o which heads the *de*P, as has been illustrated in (53). Consequently, the embedded *de*P cannot be further assigned an Agent role by the *v* in the matrix *de*P, conforming to the Theta Criterion (Chomsky 1981). Therefore, I argue that generic *de*-constructions cannot be analyzed as a subtype of non-predicative *de*-constructions (55), because there cannot be an NP argument in generic *de*-constructions.

3.2 Synthetic nominal compounds in Mandarin

3.2.1 Introduction

Like English synthetic nominal compounds e.g., *truck driver*, synthetic nominal compounds in Mandarin may be formed when a V and its internal argument surface to the left of a *n*^o, as exemplified in (56a) and (56b). In (56a), the V surfaces to the left of its internal argument, whereas in (56b), the V surfaces to the right of its internal argument. Nevertheless, there is a one-to-one correspondence between terminal nodes of the synthetic nominal compound and its corresponding generic *de*-construction in (56a') and (56b'). The synthetic nominal compounds examined in this chapter are interpreted as an Agent of the V within them.³³

³³ Thematic synthetic nominal compounds will be studied in Section 4.1.5.

- (56) a. *sheng qi shou* a'. *sheng qi de*
 raise flag raise flag
 'flag raiser' 'flag raiser'
- b. *ge chang jia* b'. *chang ge de*
 song sing sing song
 'singer' 'singer'

On the other hand, the V, the internal argument of a V, or the *de* particle in the generic *de*-construction in (57a'), (57b'), (57c') and (57d') does not have any correspondence in the corresponding synthetic nominal compound in (57a), (57b), (57c) and (57d).

- (57) a. *si ji* a'. *kai che de*
 drive vehicle drive vehicle
 'driver' 'driver'
- b. *cheng guan* b'. *guan-li cheng-shi de*
 city govern govern city
 'city governor' 'city governor'
- c. *xie shou* c'. *xie wen-zhang de*
 write write article
 'writer' 'writer'
- d. *qiu shou* d'. *da qiu de*
 ball hit ball
 'ball player' 'ball player'

In addition, notice that different VIs for 'drive' and 'vehicle' are used in (57a) and (57a'). As evidenced by the ungrammatical synthetic nominal compounds or generic *de*-constructions in

(58), I suggest that *si* is bound by *ji* and vice versa, while *kai* and *che* are free morphemes; consequently, *si* or *ji* cannot be used independently with *che* or *kai*, respectively, to form synthetic nominal compounds or generic *de*-constructions.

- | | | | | | | | | |
|------|----|--------------------|------------|--|-----|--------------------|------------|-----------|
| (58) | a. | * <i>si</i> | <i>che</i> | | a’. | * <i>si</i> | <i>che</i> | <i>de</i> |
| | | drive | vehicle | | | drive | vehicle | |
| | | Intended: ‘driver’ | | | | Intended: ‘driver’ | | |
| | b. | * <i>kai</i> | <i>ji</i> | | b’. | * <i>kai</i> | <i>ji</i> | <i>de</i> |
| | | drive | vehicle | | | drive | vehicle | |
| | | Intended: ‘driver’ | | | | Intended: ‘driver’ | | |

Finally, recall that the internal argument of the V in generic *de*-constructions can be further specified, as shown in (49). In other words, the V in generic *de*-constructions may take a specified or non-specified internal argument. By contrast, synthetic nominal compounds in Mandarin vary with respect to whether the V may take a specified internal argument. For example, in the synthetic nominal compound in (57a) and (57b), the V cannot take specified internal arguments, as evidenced by the ungrammaticality of (59a) and (59b). On the other hand, in the synthetic nominal compound in (57d), the V may take specified internal arguments, as shown in (59d). The examples in (59a’), (59b’), (59c’) and (59d’), which are right-headed N-N endocentric nominal compounds the head of which is a synthetic nominal compounds (see (57a), (57b), (57c) and (57d)) are grammatical when the non-head N is specified.

- | | | | | | | | |
|------|----|--------------------------|---------------|--|-----|----------------|--------------|
| (59) | a. | * <i>si</i> | <i>ka-che</i> | | a’. | <i>ka-che</i> | <i>si-ji</i> |
| | | drive | truck | | | truck | driver |
| | | Intended: ‘truck driver’ | | | | ‘truck driver’ | |

- | | | | |
|----|---------------------------------|-----|--|
| b. | * <i>bei-jing</i> <i>guan</i> | b'. | <i>bei-jing</i> <i>cheng-guan</i> |
| | Beijing governor | | Beijing city govern |
| | Intended: 'governor of Beijing' | | 'governor of Beijing' |
| c. | Not applicable ³⁴ | c'. | <i>ke-huan-xiao-shuo</i> <i>xie-shou</i> |
| | | | fiction writer |
| | | | 'fiction-writer' |
| d. | <i>bang-qiu</i> <i>shou</i> | d'. | <i>bang-qiu</i> <i>qiu-shou</i> |
| | baseball | | baseball player |
| | 'baseball player' | | 'baseball player' |

In Section 3.2.2, I propose that synthetic nominal compounds have the same D-structure, while the difference between synthetic nominal compounds in (56a) and (56b) with respect to surface order may be accounted for by different S-structures. In Section 3.2.3, I suggest that Fusion is a frequently used morphological operation by which certain terminal nodes of a synthetic nominal compound may be eliminated from Vocabulary Insertion, as in (57). In Section 3.2.4, I account for the ungrammatical synthetic nominal compounds or generic *de*-constructions in (58) by appealing to suppletive and contextual allomorphy. Finally, I posit that the grammaticality contrast among (59a), (59b) and (59d) may be accounted for by the s-selection requirement of the V. The morphological derivation of (59a'), (59b'), (59c') and (59d') will be discussed in Section 3.4.1.

³⁴ The example cannot be constructed because the internal argument of the V in (57c) is not realized with any VI.

3.2.2 Recategorization

I suggest that both the V and its internal argument in a synthetic nominal compound are Roots. Recall that in Harley (2009), it is proposed that in English, synthetic nominal compounds and right-headed N-N compounds have the same morphological derivation. However, I argue that synthetic nominal compounds must be structurally different from endocentric nominal compounds for two reasons: First, neither the V nor its internal argument is expected to be regarded as the head of a synthetic nominal compound; by contrast, endocentric nominal compounds are right-headed or left-headed. Second, although a Root may take an nP complement, the Root and the nP complement cannot be regarded as a V and its internal argument if the Root is not categorized as a vP. Therefore, I argue that the D-structure in (30a) is unique to endocentric nominal compounds for two reasons. First, the Root which heads the \sqrt{P} is regarded as the head of the compound. Second, the Root which takes an xP complement is not categorized as a vP.

I further argue that the S-structure in (30b) is unique to right-headed X-N compounds with an idiosyncratic interpretation, because the two Roots are embedded in the same xP/domain for non-compositional interpretation. On the other hand, each of the two Roots in a synthetic nominal compound is expected to be embedded in a different xP/domain for non-compositional interpretation, because the V and its internal argument are composed compositionally.

Therefore, I propose that synthetic nominal compounds and endocentric nominal compounds share only the internal structure of the \sqrt{P} . Specifically, I propose that, in the D-structure of synthetic nominal compounds, the \sqrt{P} is first categorized as a vP and then recategorized as an nP;³⁵ consequently, the Root which heads the \sqrt{P} may be regarded a V

³⁵ See Alexiadou 2009 for a similar analysis of Greek derived nominals.

because the \sqrt{P} is categorized as a vP, while the nP complement of the Root may be regarded as the internal argument of the V. Because the highest nP is formed when the vP is nominalized, the Root which is regarded as the V would not be regarded as the head of the compound because it is deeply embedded in the vP. Last, I suggest that the n° which nominalizes the vP is Agent-flavored, thereby the compound may be interpreted as an Agent of the V it contains.³⁶ The D-structures of (56a) and (56b) are illustrated in (60a) and (61a), respectively.

On the other hand, I propose that the surface word-order difference between the synthetic nominal compounds in (56a) and (56b) may be accounted for by different S-structures. The S-structures of (56a) and (56b) are illustrated in (60b) and (61b), respectively. I assume that $\sqrt{\text{raise}}$, $\sqrt{\text{flag}}$ and the n° which heads the highest nP are realized by *sheng*, *qi* and *shou*, respectively (60b), and $\sqrt{\text{song}}$, $\sqrt{\text{sing}}$ and the n° which heads the highest nP are realized by *ge*, *chang* and *jia*, respectively (61b).

(60) a.

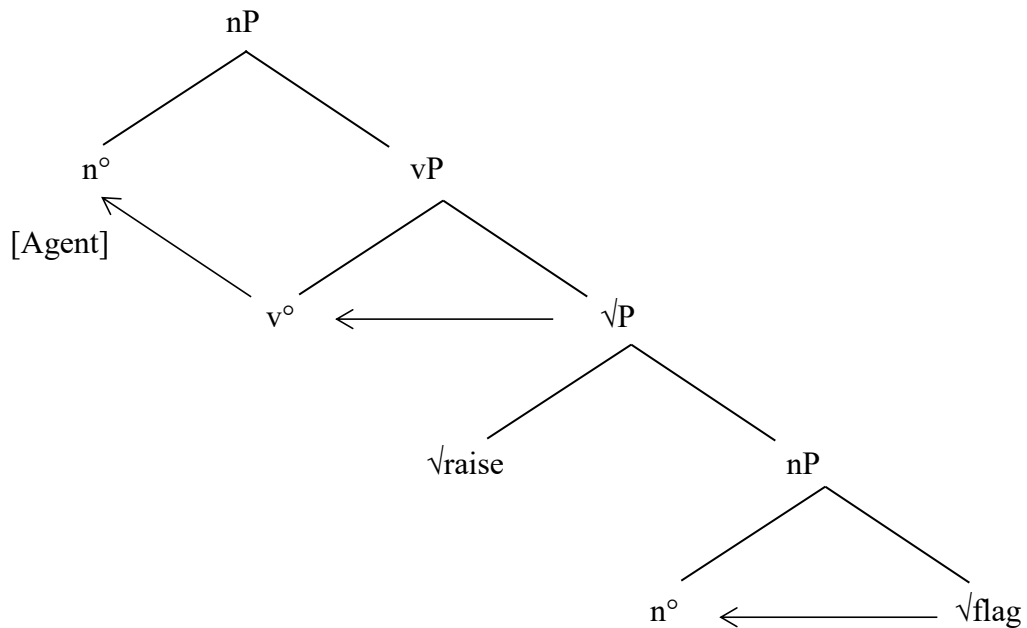

³⁶ The n° in thematic synthetic nominal compounds will be proposed to be Theme-flavored in Section 4.1.5.

b.

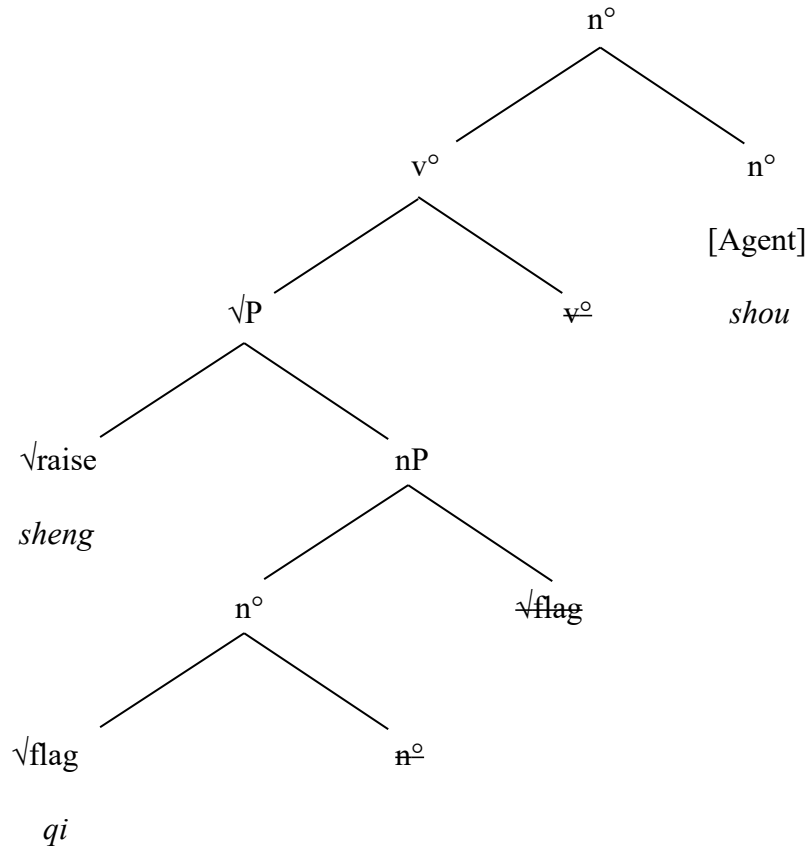

(61) a.

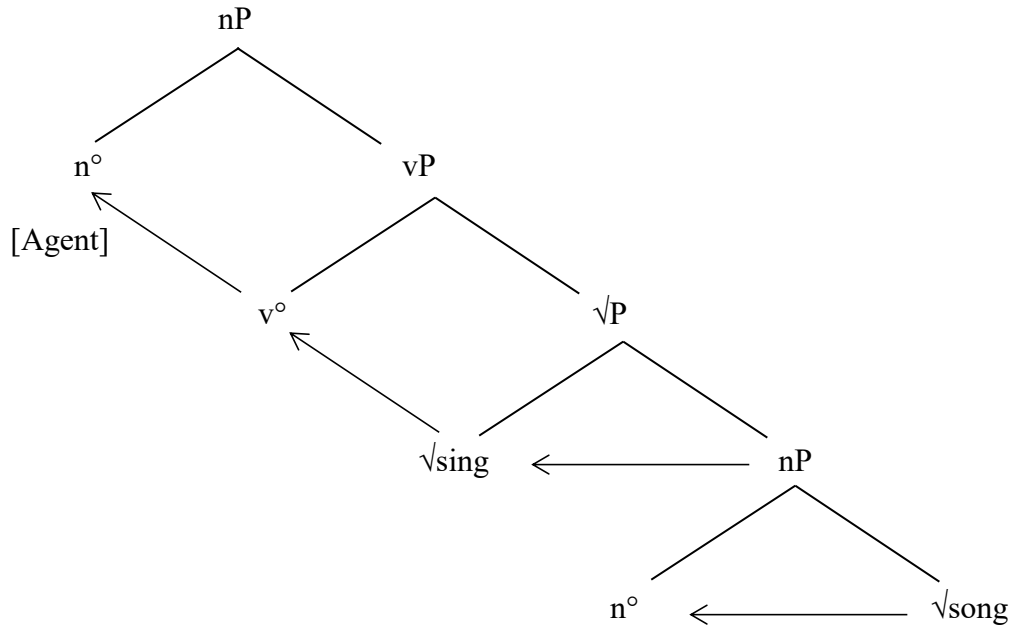

b.

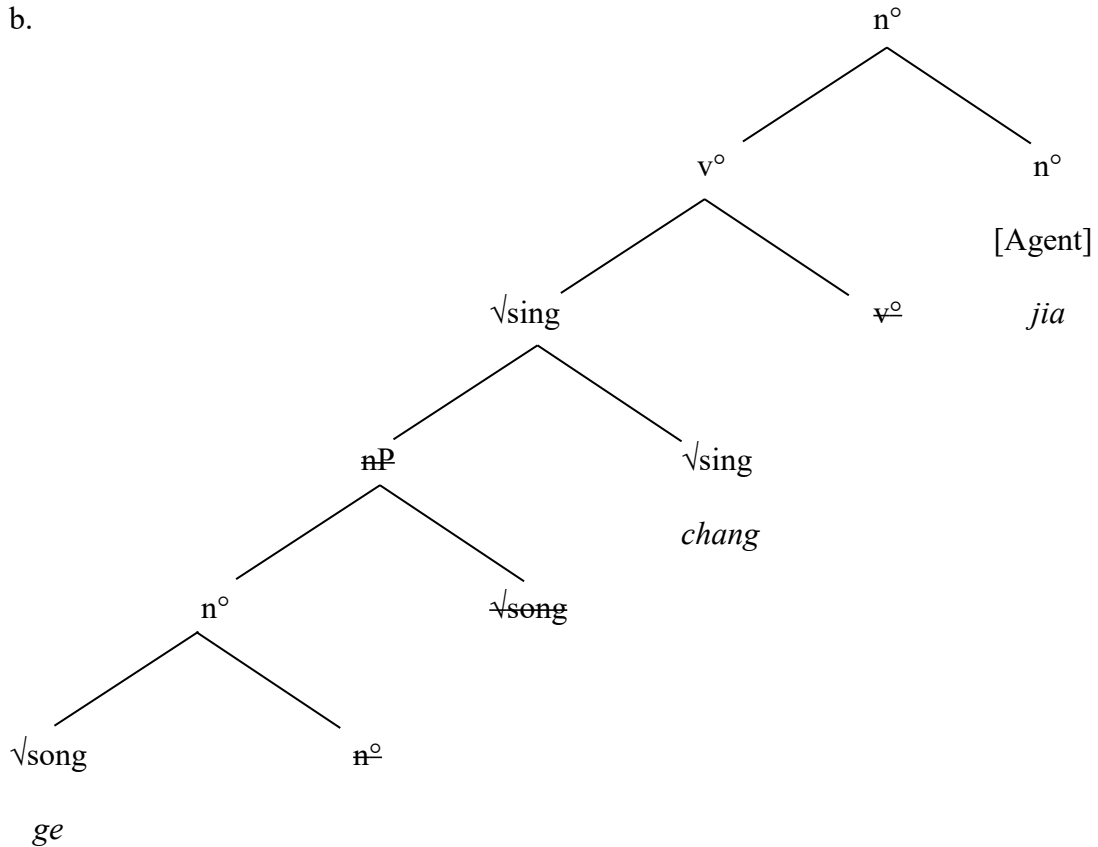

Specifically, (60b) and (61b) illustrate two possible S-structures in which the two Roots, which have been regarded as a V and its internal argument in the D-structure, may be embedded in different xPs, each of which is a domain for non-compositional interpretation in the internal structure of the n° which heads the highest nP. In such a structure, they must be composed compositionally. On the one hand, I suggest that pseudo-incorporation may take place from the \sqrt{P} to the v° , as indicated in (60a). On the other hand, I suggest that pseudo-incorporation may take place from the embedded nP to the Root which heads the \sqrt{P} , as indicated in (61a). Consequently, the two Roots do not invert in (60b), but do in (61b). In addition, I assume that the v° is also fused into the \sqrt{P} as a result of pseudo-incorporation in (60b), and the v° is fused into the Root which heads the \sqrt{P} in (61b). As a result, the v° is not subject to Vocabulary Insertion in either (60b) or (61b). I also assume that the Root in the complement of the nP

complement incorporates into the n° which heads that nP complement, and the n° is also fused into the Root as a result of incorporation, in addition to v° -to- n° head movement, because incorporation or head movement into an x° is mandatory for each xP.

3.2.3 Fusion

I suggest that synthetic nominal compounds in (57) have the same morphological derivations as synthetic nominal compounds in (56), which has been illustrated in (60) and (61). I further suggest that Fusion is a frequently used morphological operation by which certain terminal nodes of a synthetic nominal compound may be eliminated from Vocabulary Insertion.

Compared with (56a), the n° in (57a) is not realized with any VI. I propose that the synthetic nominal compound in (57a) has the same morphological derivation as the synthetic nominal compound in (56a), except that the n° which heads the highest nP is fused into the v° as a result of head movement; consequently, the n° is not subject to Vocabulary Insertion. The D-structure and S-structure of (57a) are illustrated in (62a) and (62b). I assume that $\sqrt{\text{drive}}$ and $\sqrt{\text{vehicle}}$ are realized by *si* and *ji*, respectively.

(62) a.

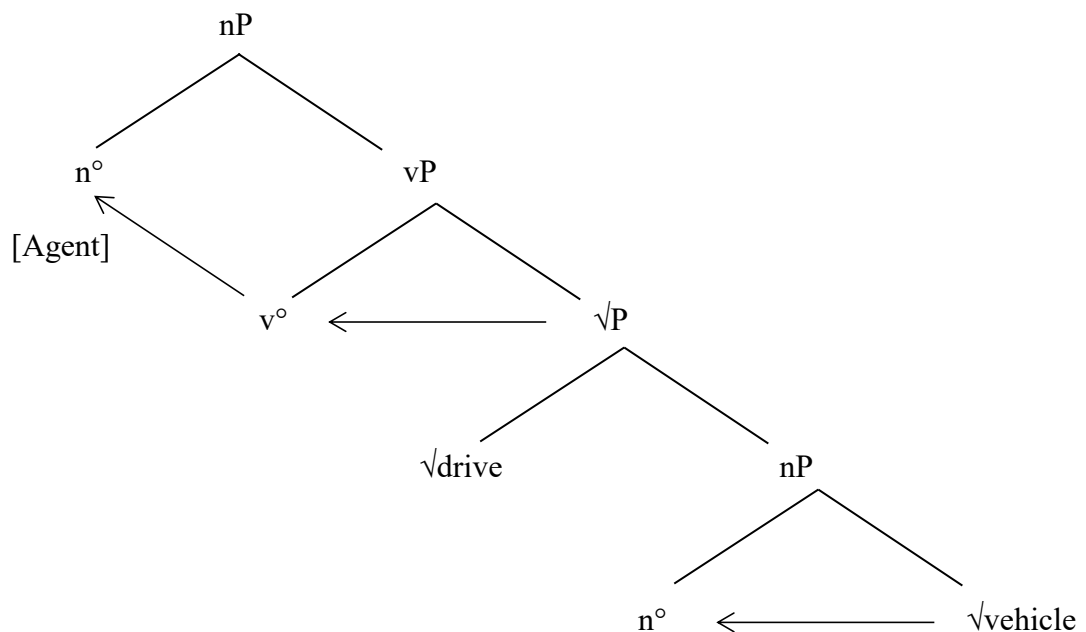

b.

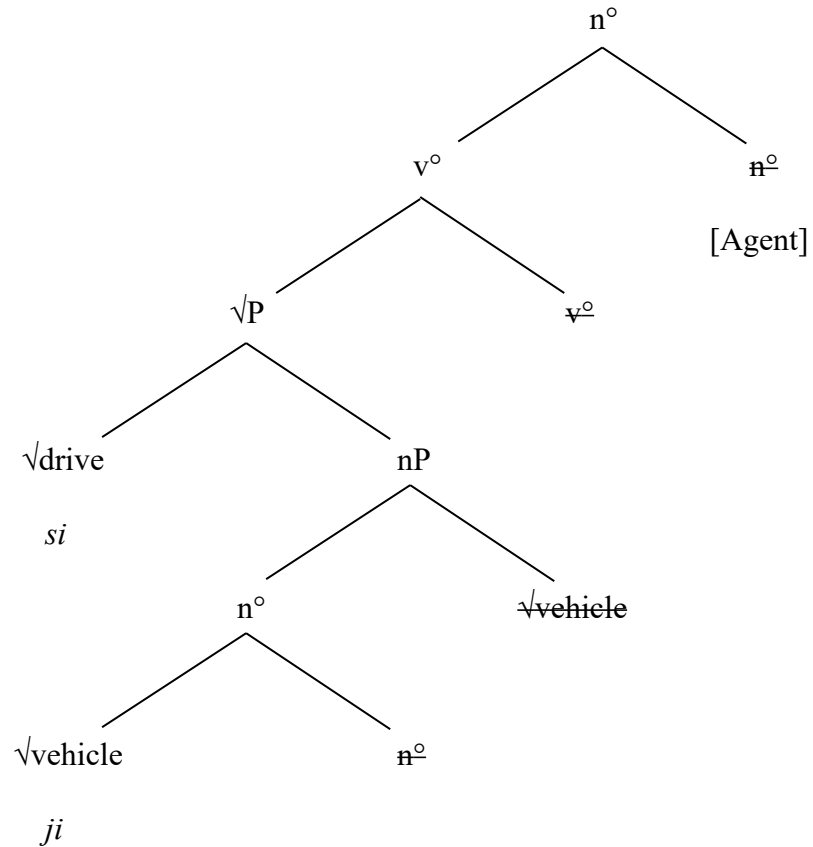

On the other hand, I propose that the synthetic nominal compound in (57b) has the same morphological derivation as the synthetic nominal compound in (56b), except that the n° which heads the highest nP is fused into the v° as a result of head movement. Consequently, the n° is not subject to Vocabulary Insertion. The D-structure and S-structure of (57b) are illustrated in (63a) and (63b). I assume that $\sqrt{\text{city}}$ and $\sqrt{\text{govern}}$ are realized by *cheng* and *guan*, respectively.

(63) a.

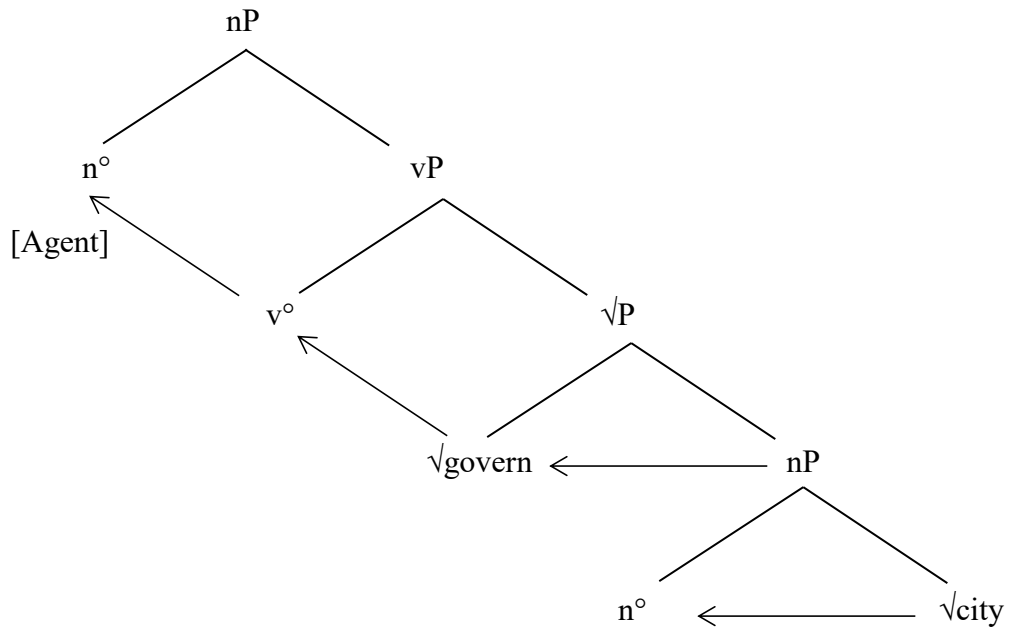

b.

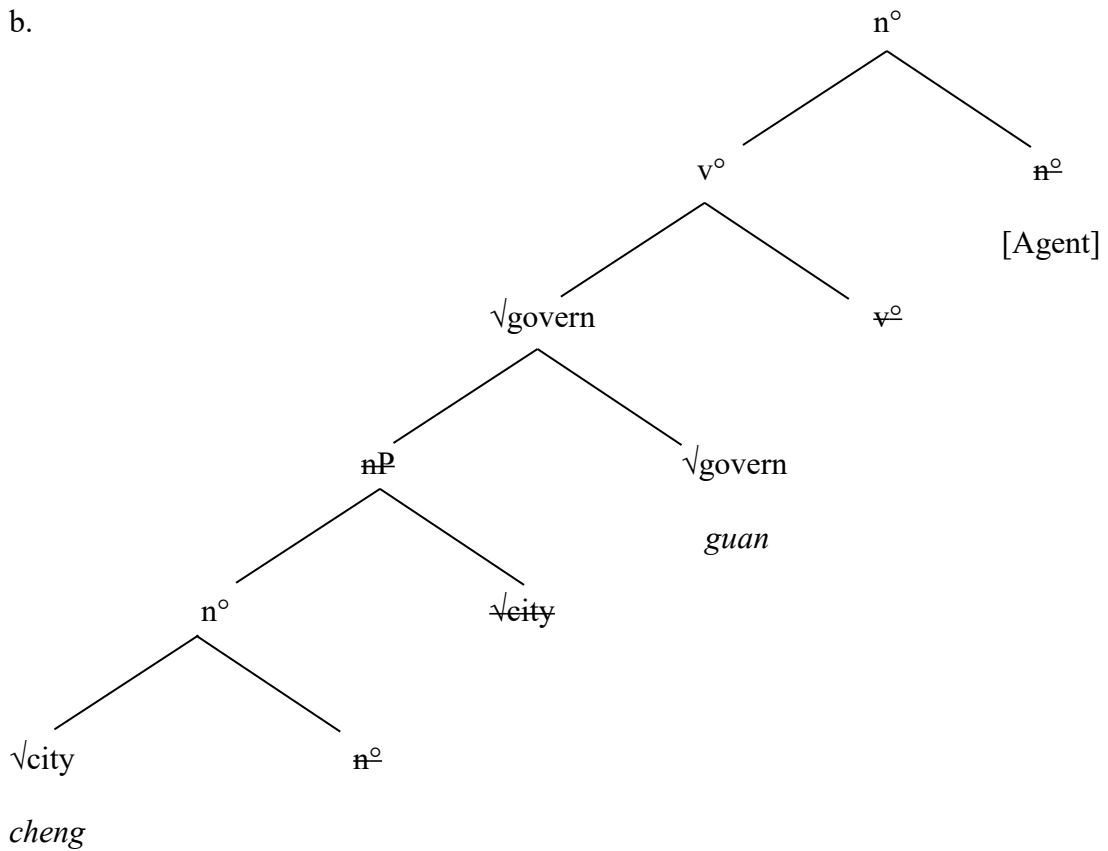

Similarly, I suggest that the synthetic nominal compound in (57c) also has the same morphological derivation as the synthetic nominal compound in (56b), except that the nP

complement is fused into the Root which heads the \sqrt{P} as a result of pseudo-incorporation. As a result, terminal nodes which are embedded in the nP are not subject to Vocabulary Insertion. The D-structure and S-structure of (57c) are illustrated in (64a) and (64b). I assume that $\sqrt{\text{write}}$ and the n° which heads the highest nP are realized by *xie* and *shou*, respectively.

(64) a.

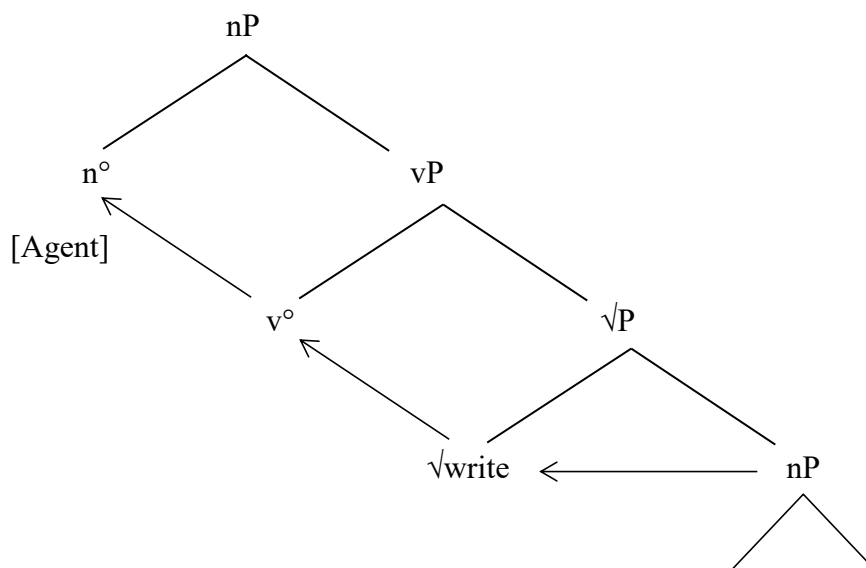

b.

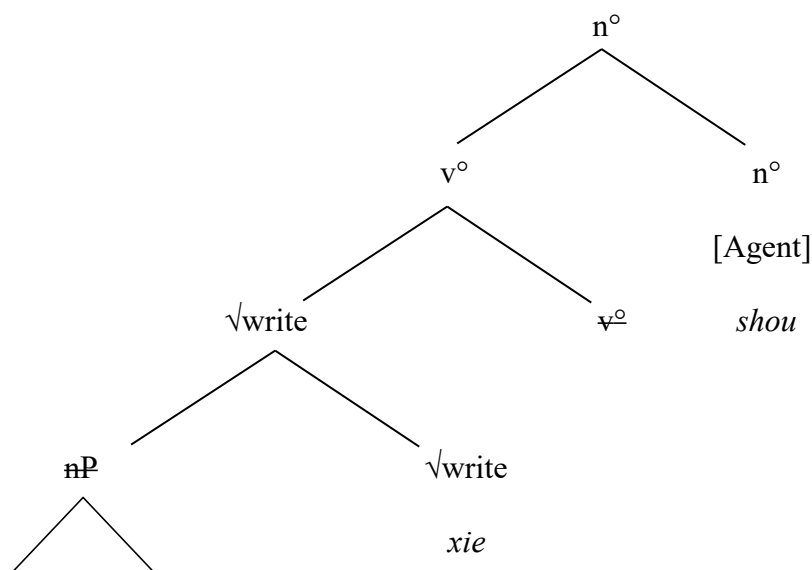

Finally, I propose that the synthetic nominal compound in (57d) also has the same morphological derivation as the synthetic nominal compound in (56b), except that it is the Root which heads the \sqrt{P} that is fused into the nP complement as a result of pseudo-incorporation.

Therefore, the Root which heads the \sqrt{P} that is not subject to Vocabulary Insertion. The D-structure and S-structure of (57d) are illustrated in (65a) and (65b). I assume that $\sqrt{\text{ball}}$ and the n° which heads the highest nP are realized by *qiu* and *shou*, respectively.

(65) a.

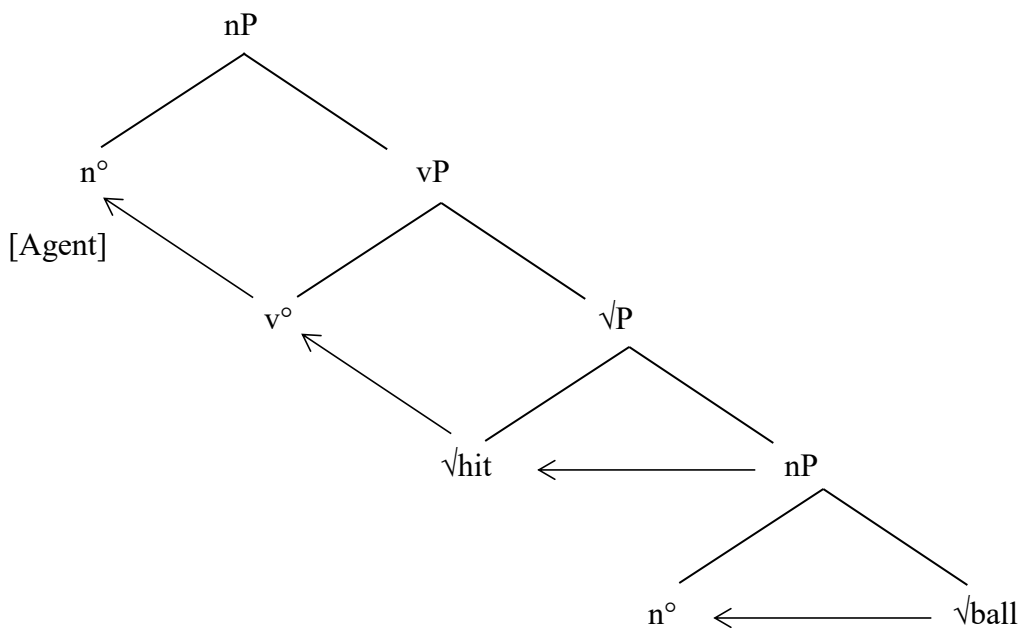

b.

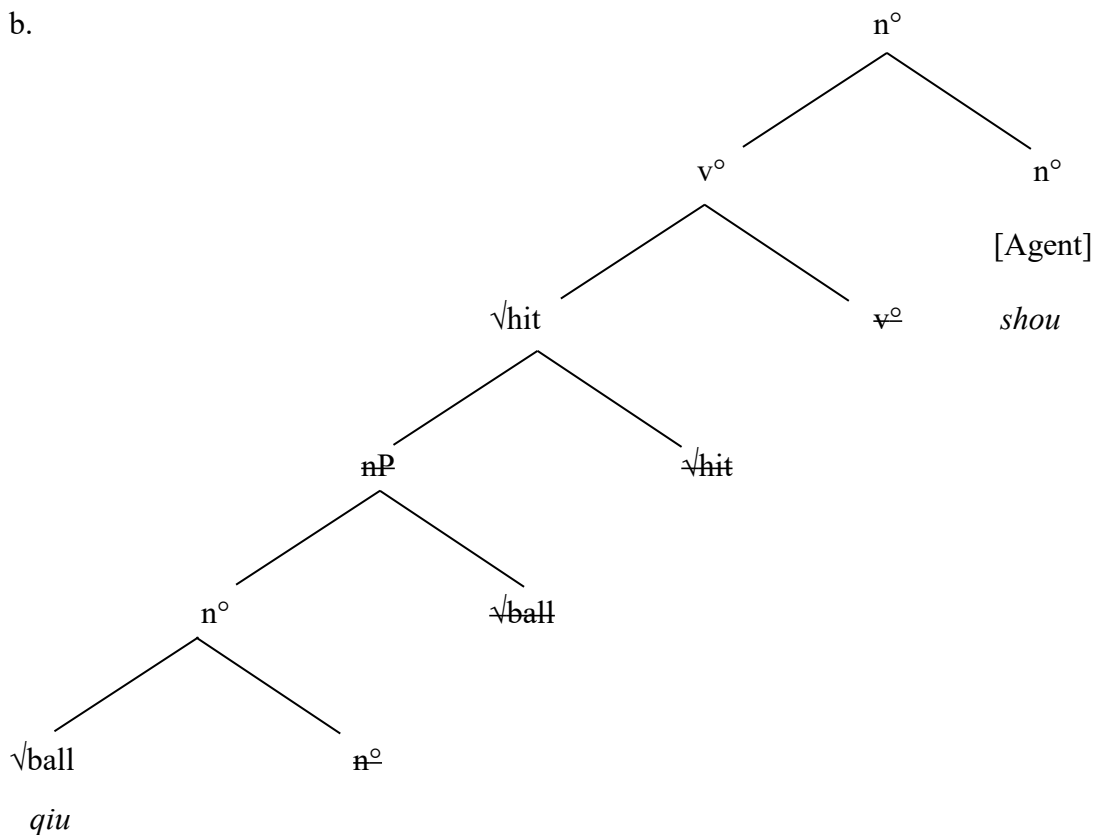

3.2.4 Root allomorphy

To account for the ungrammatical constructions in (58), I suggest that *si* and *ji* are the suppletive VIs for *kai* and *che* for $\sqrt{\text{drive}}$ and $\sqrt{\text{vehicle}}$, respectively. This means that *si* and *ji* must be more specified than *kai* and *che*. Therefore, (58a) and (58b) are ungrammatical because $\sqrt{\text{drive}}$ or $\sqrt{\text{vehicle}}$ may be realized by *kai* or *che* only when the more specified VI, *si* or *ji*, cannot be inserted.

I further propose that *si* and *ji* are contextually specified. Because *si* and *ji* are expected to be inserted to $\sqrt{\text{drive}}$ and $\sqrt{\text{vehicle}}$ in (62), I posit that *si* may realize $\sqrt{\text{drive}}$ only when there is another Root, such as $\sqrt{\text{vehicle}}$, in the same syntactic terminal node/domain for contextual allomorphy; similarly, *ji* may realize $\sqrt{\text{vehicle}}$ only when there is another Root, such as $\sqrt{\text{drive}}$, in the same syntactic terminal node/domain for contextual allomorphy. Because in (52), $\sqrt{\text{drive}}$ is embedded in a V, whereas $\sqrt{\text{vehicle}}$ is embedded in an NP, it follows that $\sqrt{\text{drive}}$ and $\sqrt{\text{vehicle}}$ are not in the same syntactic terminal node/domain for contextual allomorphy. Therefore, (58a) and (58b) are ungrammatical because $\sqrt{\text{drive}}$ and $\sqrt{\text{vehicle}}$ cannot be realized by *si* and *ji*; instead, *kai* and *che* must be inserted to $\sqrt{\text{drive}}$ and $\sqrt{\text{vehicle}}$ even if they are less specified.

Notably, because the single Spell-Out model of morpho-syntax postulates that Vocabulary Insertion is free within the same syntactic terminal node/domain for contextual allomorphy, the fact that a morpheme is bound does not have imply that it is structurally less embedded. For example, the fact that *ji* is bound by *si* does not imply that $\sqrt{\text{vehicle}}$ is less embedded than $\sqrt{\text{drive}}$. Moreover, because $\sqrt{\text{drive}}$ and $\sqrt{\text{vehicle}}$ are realized freely, both $\sqrt{\text{drive}}$ and $\sqrt{\text{vehicle}}$ may be realized with bound morphemes. Evidently, *si* is bound by *ji* and vice versa.

To reiterate, I have shown that free morphemes, such as *kai* and *che*, are not contextually specified. On the other hand, bound morphemes, such as *si* and *ji*, which are the suppletive VIs

of *kai* and *che*, are contextually specified. According to the single Spell-Out model of morpho-syntax, because Vocabulary Insertion is cyclic among syntactic terminal nodes, each of which is a domain for contextual allomorphy, terminal nodes of generic *de*-constructions must be free. Consequently, only *kai* and *che* may realize $\sqrt{\text{drive}}$ and $\sqrt{\text{vehicle}}$ in (52). On the other hand, because Vocabulary Insertion is free within the same syntactic terminal node/domain for contextual allomorphy, terminal nodes of synthetic nominal compounds may be left-bound or right-bound. Therefore, *si* may be bound by *ji* and vice versa in (62).³⁷

3.2.5 The selection of the nP complement

Grimshaw (1979) distinguishes between two types of selection, which are referred to as c(ategory)-selection and s(emantic)-selection in Pesetsky (1982). For example, a V may c-select a complement of a certain syntactic category, and s-select an argument of a certain semantic type. Therefore, the complement argument of a V must not violate either c-selection or s-selection requirements of the V. Merchant (2017) suggests that Roots cannot implement selection requirements;³⁸ on the other hand, an x° may have two selectional features. Because the complement of the Root which heads the $\sqrt{\text{P}}$ in synthetic nominal compounds can only be an nP, I suggest that the nP complement, in addition to the Root which heads the $\sqrt{\text{P}}$, is c-selected by the v° which categorizes the $\sqrt{\text{P}}$ as a vP, because if the complement were c-selected by the Root, it would be expected that the complement could also be an aP, as in right-headed A-N compound.

³⁷ The alternation between *shou*, as in (56a), and *jia*, as in (56b), is a case of x° allomorphy, which I will leave to future research.

³⁸ Therefore, Roots cannot take complement arguments, as assumed by a body of research (see Harley 2014). However, this thesis adopts the assumption that Roots can take complement arguments (à la Harley 2014).

Nevertheless, the grammaticality contrast among (59a), (59b) and (59d) cannot be accounted for by an s-selection requirement of the v° , because the same v° is postulated in the morphological derivation of every synthetic nominal compound. On the other hand, the ungrammaticality of (59a) and (59b) seems to suggest that nP truck and nP Beijing, which are more specified than nP vehicle and nP city, incur a violation of the s-selection requirement of $\sqrt{\text{drive}}$ and $\sqrt{\text{govern}}$, respectively. In other words, $\sqrt{\text{drive}}$ and $\sqrt{\text{govern}}$ may only s-select arguments that are non-specified. On the other hand, because (59d) is grammatical, it seems that $\sqrt{\text{sing}}$ may s-select argument that are specified, or non-specified, as in (57d). To this end, I suggest that Roots can s-select their arguments.

To reiterate, I propose that, in the morphological derivation of synthetic nominal compounds, the nP complement of the Root which heads the \sqrt{P} is c-selected by the v° which categorizes the \sqrt{P} as a vP ; on the other hand, the nP complement is s-selected by the Root which heads the \sqrt{P} . Because $\sqrt{\text{drive}}$ and $\sqrt{\text{govern}}$ may only s-select non-specified arguments, the nP truck (59a') and the nP Beijing (59b') incur a violation of the s-selection requirement of $\sqrt{\text{drive}}$ and $\sqrt{\text{govern}}$, respectively. As a result, (59a') and (59b') are ungrammatical.

3.3 Some cross-linguistic generalizations

So far, the paper has shed light on the syntactic derivation of two types of nominal phrases, i.e., non-predicative *de*-constructions and generic *de*-constructions, and the morphological derivation of two types of nominal compounds, i.e., endocentric nominal compounds and synthetic nominal compounds, in Mandarin. While English endocentric nominal compounds have been addressed in Section 2.2.1, nominal phrases and synthetic nominal compounds in English have not yet been addressed. In Section 3.3.1, it will be argued that

English “phrasal compounds” should be analyzed as nominal phrases (rather than nominal compounds). In Section 3.3.2, I will show that synthetic nominal compounds in English have the same morphological derivation as Mandarin synthetic nominal compounds.

3.3.1 “Phrasal compounds” in English

In Harley (2009), English “phrasal compounds” where an XP seems to constitute the non-head element of an endocentric nominal compound, as exemplified in (66), are analyzed as a subtype of endocentric nominal compounds in which x° -to-Root head movement does not take place. However, because I have proposed that the lack of x° -to-Root head movement in the morphological derivation of an endocentric nominal compound would not only result in a left-headed N-X compounds, but also result in a non-restrictive interpretation of the non-head element, I suggest that phrasal compounds cannot be analyzed as endocentric nominal compounds. This is because not only are English phrasal compounds, such as those in (66), right-headed, but also the non-head element in each of the phrasal compounds serves as a restrictive modifier of the head of the compound.

- (66)
- a. These aren't your standard *stuff-blowing-up effects*.
 - b. When he's not in that mode, though, he does an excellent job with the *bikini-girls-in-trouble genre*.
 - c. I've always found it odd that the people who complain most about realism are *comic-book and science-fiction fans*.
 - d. There's the aforementioned bestiality and *drooling-stroke-victim jokes*.

On the other hand, I propose that English phrasal compounds may be structurally similar to Mandarin non-predicative *de*-constructions, where not only does the NP surface to right of the XP, but also the XP serves as a restrictive modifier of the NP. I will leave a detailed analysis of English phrasal compounds to future research.

It is also noted in Harley (2009) that a phrasal compound may be formed when an XP is directly attached to a derivational affix, as in (67). Because *-ish* (67a), *-y* (67b), and *-ness* (67c) all c-select an nP complement, Harley (2009) suggests that each XP in (67) must have undergone a zero-derivation (Sato 2007) prior to affixation; that is, each XP is categorized by a phonologically null n° as an nP.

- (67) a. feeling a bit *rainy-day-ish*
b. a bit *don't bother-y*
c. the general *bikini-girls-in-trouble-ness* of it all

From a Renumeration perspective, this means that an XP formed in a syntactic derivation may reenter the Numeration as an xP, thereby the xP may be selected in a further morphological derivation. Nevertheless, I suggest that morphological derivations cannot proceed from syntactic derivations.³⁹ Because I have proposed that English phrasal compounds in (66) should be analyzed as nominal phrases, rather than as nominal compounds, I further propose that each XP in (67) is nominalized by an English counterpart of the de° , which is phonologically null, prior to affixation. Specifically, I posit that, in the syntactic derivation of (67a), the de° c-selects an NP; in the syntactic derivation of (67b), the de° c-selects a VP (or NegP, arguably); in the syntactic derivation of (67c), the de° c-selects a SC.

³⁹ This claim needs to be elaborated more in future research.

3.3.2 Synthetic nominal compounds in English

Bauer (2004) suggests that English synthetic nominal compounds are originated from compounds made up of a V and its internal argument (68a). Notably, English synthetic nominal compounds also exhibit a three-way variations with respect to surface form, as exemplified in (68b), (68c), and (68d). I propose that the morphological derivation proposed earlier for each type of synthetic nominal compounds in Mandarin (see Sections 3.2.2 and 3.2.3) may also account for the corresponding compounds in (68). Specifically, (68a) has the same morphological derivation as (57a), which has been illustrated in (62); I assume that *pick* and *pocket* realize $\sqrt{\text{pick}}$, which heads the $\sqrt{\text{P}}$, and $\sqrt{\text{pocket}}$, which is embedded in the nP complement, respectively. (68b) has the same morphological derivation as (56b), which has been illustrated in (61); I assume that *truck*, *drive*, and *-er* realize $\sqrt{\text{truck}}$, which is embedded in the nP complement, $\sqrt{\text{drive}}$, which heads the $\sqrt{\text{P}}$, and the n° which heads the highest nP, respectively. (68c) has the same morphological derivation as (57c), which has been illustrated in (64); I assume that *drive* and *-er* realize $\sqrt{\text{drive}}$, which heads the $\sqrt{\text{P}}$, and the n° which heads the highest nP, respectively. Finally, (68d) has the same morphological derivation as (57d), which has been illustrated in (65); I assume that *truck* and *-er* realize $\sqrt{\text{truck}}$, which is embedded in the nP complement, and the n° which heads the highest nP, respectively.

- (68) a. pick-pocket
b. truck-driver
c. driver
d. trucker

In addition, Alexiadou and Iordachioaia (2015) notice that other synthetic nominal compounds in English, which they refer to as deverbal compounds, may be interpreted idiosyncratically. Specifically, the compounds in (69a) and (69b) are interpreted idiosyncratically because they are built from verbal idioms, whereas the compounds in (69c) and (69d) exist themselves as idioms in the absence of a corresponding verbal idiom.

- | | | | | |
|------|----|-------------|-----|-------------------|
| (69) | a. | eye-catcher | a'. | to catch the eye |
| | b. | ice-breaker | b'. | to break the ice |
| | c. | face-lifter | c'. | #to lift (a) face |
| | d. | baby-sitter | d'. | *to sit (a) baby |

I propose that the compounds in (69) have the same morphological derivation. The morphological derivation of the deverbal compound in (69a) is illustrated in (70). Compared with (61), where pseudo-incorporation takes place from the nP complement to the Root which heads the \sqrt{P} , in (70), head movement takes place instead from the n° which heads nP complement to the Root which heads the \sqrt{P} . Consequently, the Root which is regarded as the V and the Root which is regarded as the internal argument of the V are embedded in the same xP/domain for non-compositional interpretation. According to the single Spell-Out model of morpho-syntax, the Roots may be interpreted idiosyncratically.

(70) a.

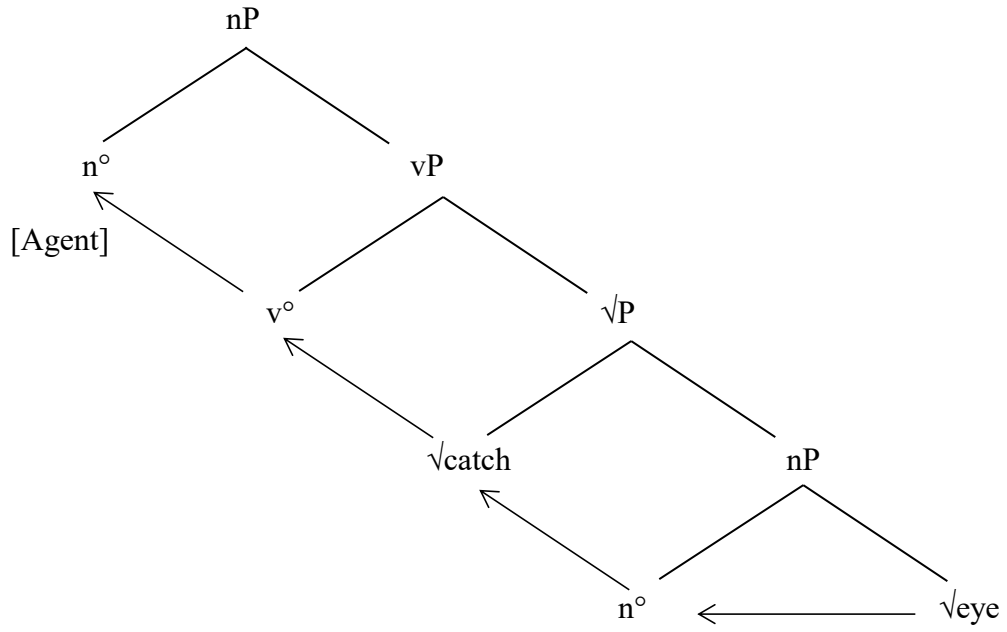

b.

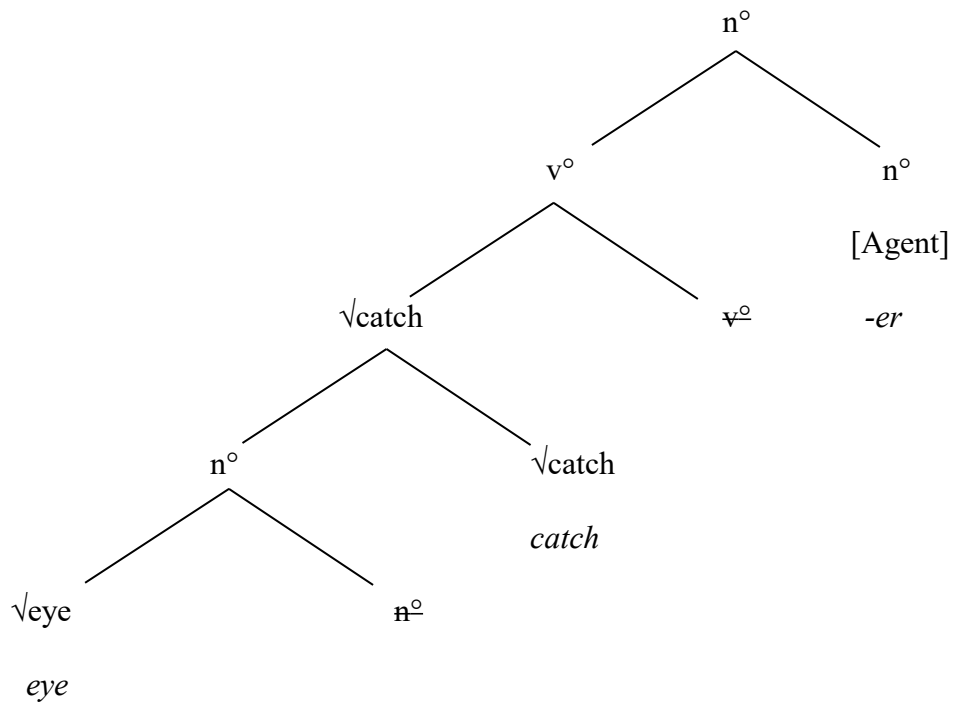

3.4 Interim summary

3.4.1 More on Renumeration

The proposal that morphological derivations proceed to syntactic derivations via Renumeration has been further instantiated in the morpho-syntactic derivation (52) of generic *de*-constructions such as (48a).

As noted in Section 3.2.1, the head N of a right-headed N-N compound may be a synthetic nominal compound. I posit that the highest nP formed in the morphological derivation of a synthetic nominal compound, such as (57a), (57b), (57c) or (52d), may reenter the Numeration as a Root, thereby the Root may be selected to head the \sqrt{P} in the morphological derivation of a right-headed N-N compound, such as (59a'), (59b'), (59c') or (59d').

In addition, an endocentric nominal compound the head of which is a synthetic nominal compound may not only be interpreted compositionally, as in (59a'), (59b'), (59c') and (59d'), but also idiosyncratically, as shown in (71a) and (71b).⁴⁰ This also suggests that a morphological derivation may proceed to a subsequent morphological derivation.

(71)	a.	<i>lao</i>	<i>si-ji</i>	a'.	<i>lao</i>	<i>de</i>	<i>si-ji</i>
		old	driver		old		driver
		'expert'			'old driver'		
	b.	<i>ling-hun</i>	<i>ge-shou</i>	b'.	* <i>ling-hun</i>	<i>de</i>	<i>ge-shou</i>
		soul	singer		soul		singer
		'extremely good/bad singer'			Intended: 'soul's singer'		

⁴⁰ Note that (71a) and (71b) do not have the same interpretation as the corresponding non-predicative *de*-constructions (71a') and (71b').

3.4.2 More on LF

I have shown that the interpretation of a generic *de*-construction, where a VP surfaces to the left of the *de* particle, such as (48a), is based on the internal structure, i.e. the specifier VP, the head *de*^o, and the complement *vP* of the *deP* in (53). Because the VP and the *de*' are composed by means of modification, the VP is interpreted as a restrictive modifier.

The proposal that the first xP in which each Root is embedded is the domain for non-compositional interpretation has also been further instantiated. On the one hand, it has been shown that Roots each of which is embedded in a different xP/domain for non-compositional interpretation must be interpreted compositionally. For example, not only the V and its internal argument in generic *de*-constructions (see (48a), the morpho-syntactic derivation of which has been illustrated in (52)), but also the Roots which are regarded as the V and its internal argument in synthetic nominal compounds (see (56) and (57), the morphological derivation of which have been illustrated in (60) through (65)) are interpreted compositionally.

On the other hand, it has been shown that, if the two Roots in a synthetic nominal compounds are embedded in the same xP/domain for non-compositional interpretation, then the compound may be interpreted idiosyncratically. For example, the deverbal compounds in (69), the morphological derivation of which has been illustrated in (70), are interpreted idiosyncratically, because the two Roots in the compounds are embedded in the same xP/domain for non-compositional interpretation.

3.4.3 More on PF

As has been particularly discussed in Section 3.2.3, a lack of isomorphism between a generic *de*-construction and its corresponding synthetic nominal compound in Mandarin may indicate that Fusion has taken place in the derivation of the compound. Similarly, surface form variations among English synthetic nominal compounds (68) further shows that Fusion is a frequently used morphological operation by which certain terminal nodes of a synthetic nominal compound may be eliminated from Vocabulary Insertion.

In addition, the proposal that each terminal node of a syntactic derivation (including an X or XP which is renumerated from the highest xP formed in a morphological derivation) is a domain for contextual allomorphy, has been instantiated. On the one hand, because each of the two Roots which are embedded in the V and the NP (the internal argument of the V) in a generic *de*-construction (see (48a), the morpho-syntactic derivation of which has been illustrated in (52)) is embedded in a different syntactic terminal node/domain for contextual allomorphy and realized in a cyclic manner, both Roots must be realized with a free morpheme. On the other hand, because the two Roots in a synthetic nominal compound (see (57a), the morphological derivation of which has been illustrated in (62)) are embedded in the same syntactic terminal node/domain for contextual allomorphy and realized freely, each Root may be realized by a morpheme which is bound to the left or to the right.

Up to this point, every aspect of the single Spell-Out model of morpho-syntax has been examined through the study of the two types of nominal phrases, non-predicative *de*-constructions and generic *de*-constructions, and the two types of nominal compounds, endocentric nominal compounds and synthetic nominal compounds in Mandarin (and English).

3.4.4 More on the similarities between morphological and syntactic derivations

Last but not least, the morphological derivation of synthetic nominal compounds and the syntactic derivation of generic *de*-constructions also exhibit similarities with respect to both D-structure and S-structure. I suggest that the similarities may have consequences for the nature of nominalization and its relation to argument structure.

With respect to D-structure, in the morphological derivation of synthetic nominal compounds (60a), the \sqrt{P} is first merged with a v° which heads a vP , which is in turn merged with an Agent-flavored n° that heads an nP . Similarly, in the syntactic derivation of generic *de*-constructions (52), the VP is first merged with a v which heads a vP , which is further merged with an Agent-flavored de° that heads a *deP*.

With respect to S-structure, in the morphological derivation of synthetic nominal compounds where the V surfaces to the left of its internal argument (60b), the two Roots do not invert because the \sqrt{P} , in which both Roots are embedded, is pseudo-incorporated into the v° . Similarly, in the syntactic derivation of generic *de*-constructions (48), the V and its internal argument do not invert because it is the entire VP , consisting of both the V and the NP complement, that is raised to the specifier of the *deP*.

Chapter 4 The syntax of other *de*-constructions and the morphology of other nominal compounds in Mandarin

In this chapter, I will present partial analyses of several other types of nominal phrases and nominal compounds in Mandarin which I will continue to study in future research. Specifically, I will discuss some variants of non-predicative *de*-constructions and generic *de*-constructions, and their implications for the analysis of right-headed V-N compounds and thematic synthetic nominal compounds. I suggest that nominal phrases and nominal compounds where an event structure is involved are always interpreted compositionally. In addition, I will also compare cases of apposition in non-predicative *de*-constructions with exocentric nominal compounds. I propose that apposition in non-predicative *de*-constructions is formed through Merge without projection between two XPs of the same syntactic category. I further propose that the compositional or idiosyncratic interpretation of an exocentric nominal compound arises from apposition (Merge without projection between two xPs of the same syntactic category) or from Root Merger (Merge without projection between two Roots), respectively.

4.1 Event structure in nominal phrases and nominal compounds

4.1.1 More on non-predicative *de*-constructions

Recall that, in non-predicative *de*-constructions where an NP argument is modified by a VP modifier, the NP argument may be interpreted as an external argument of the VP, such as an Agent (17a), a Location (19a) or an Instrument (19b). When the NP argument is an Agent of the VP, the Location or the Instrument of the VP may be introduced in the same non-predicative *de*-construction by an additional P or V, as shown in (72a) and (72b).

- (72) a. *zai shi-tang li chi shi-wu de shi-ke*
 PREP eatery in eat food eater
 ‘food-eating eater in an eatery’
- b. *yong shi-ju chi shi-wu de shi-ke*
 use tableware eat food eater
 ‘food-eating eater using some tableware’

On the other hand, when the NP argument is a Location or an Instrument of the VP, the Agent (NP) of the VP may be introduced directly in the same non-predicative *de*-construction, as shown in (73a) and (73b).

- (73) a. *shi-ke chi shi-wu de shi-tang*
 eater eat food eatery
 ‘food-eating eatery for an eater’
- b. *shi-ke chi shi-wu de shi-ju*
 eater eat food tableware
 ‘food-eating tableware for an eater’

Structurally speaking, I suggest that the additional PP, VP or NP in (72) and (73) is introduced by an additional extended projection of the VP. That is, the additional PP, VP or NP is base-generated in the specifier of an additional *v*P. I further posit that the additional *v*P is structurally more embedded than the *v*P, in the specifier of which the NP argument is base-generated. The D-structure of (72a) is illustrated in (74).⁴¹

⁴¹ Because Vocabulary Insertion has not taken place at this point, glosses are used instead for each syntactic terminal nodes.

(74)

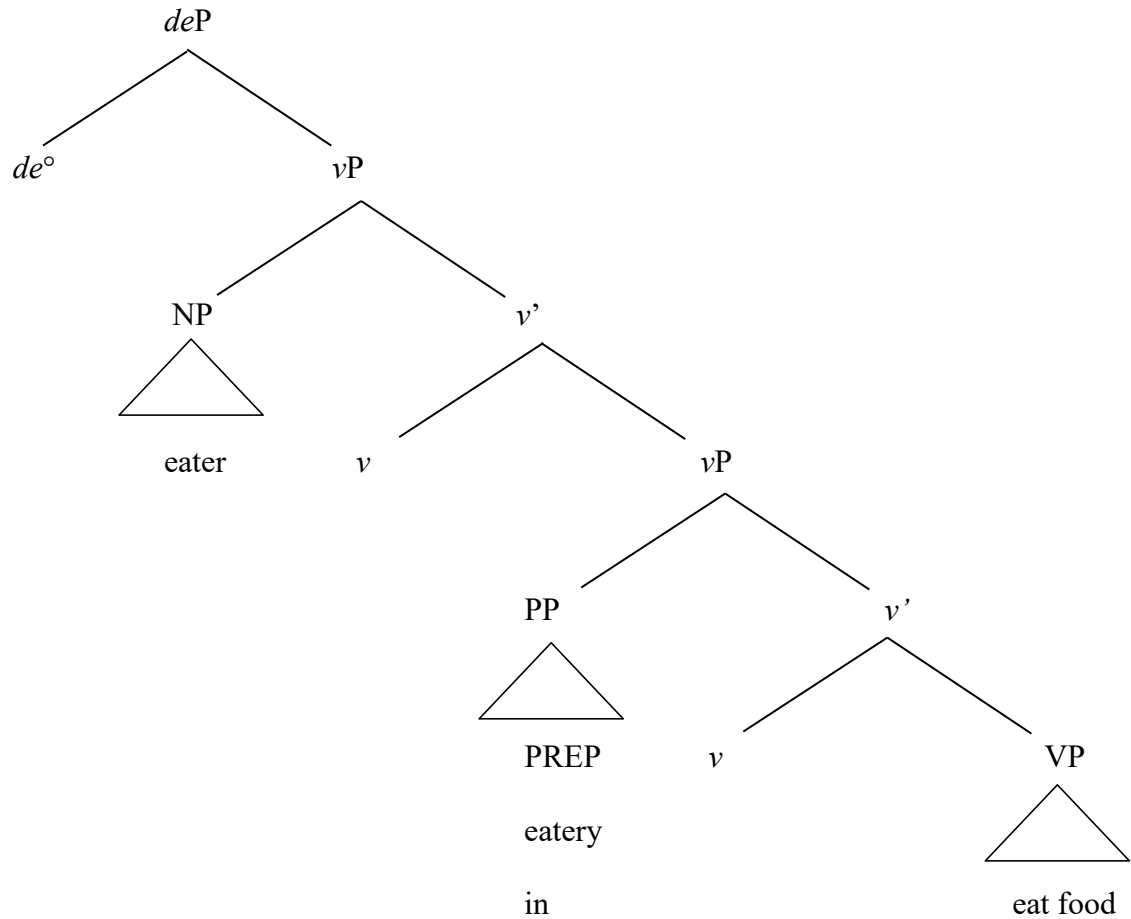

In order to derive the expected surface word order, it is necessary to propose the embedded *vP* is raised to the specifier of the *deP* in the S-structure. Because the *vP* has been analyzed as being of type $\langle e, t \rangle$, while the *de'* is of type $\langle e \rangle$ (see Sections 2.1.5 and 3.1.2), the *de'* would saturate the *vP* as an argument.

From a more semantic perspective, I suggest that there is an event structure involved in the non-predicative *de*-constructions in (72) and (73), because the interpretation of both (72a) and (73a) may be captured by making reference to an event (Davidson 1967), as shown in (75a); The same is true for (72b) and (73b), as shown in (75b).

- (75) a. $\exists e[\text{eat}(\text{food})(\text{eater})(e) \wedge \text{in}(\text{eatery})(e)]$
 b. $\exists e[\text{eat}(\text{food})(\text{eater})(e) \wedge \text{use}(\text{tableware})(e)]$

In Section 4.1.2, I will show that the interpretation of a thematic non-predicative *de*-construction may also be captured by making reference to some event. In addition, thematic non-predicative *de*-constructions will be compared with thematic generic *de*-constructions. In Section 4.1.3, I will discuss two types of nominal compounds where an event structure also seems to be involved. I suggest that nominal phrases and nominal compounds which involve an event structure are always interpreted compositionally. Therefore, in Section 4.1.4, I propose that right-headed V-N compounds are always interpreted compositionally. In Section 4.1.5, the analysis of thematic synthetic nominal compounds will be addressed.

4.1.2 Thematic non-predicative *de*-constructions and thematic generic *de*-constructions

As exemplified in the nominal phrases in (76), which I refer to as thematic non-predicative *de*-constructions, the NP argument which surfaces to the right of the *de* particle is the Theme of the V. Compared with (76d), an additional PP consisting of an NP that is the Location of the V (76a), or a VP which consists of an NP that is the Instrument of the V (76b), or an NP which is the Agent of the V (76c) may be introduced in the same thematic non-predicative *de*-construction.

- (76) a. *zai* *shi-tang* *li* *chi* *de* *shi-wu*
 PREP eatery in eat food
 ‘food to eat in an eatery’
- b. *yong* *shi-ju* *chi* *de* *shi-wu*
 use tableware eat food
 ‘food to eat using some tableware’
- c. *shi-ke* *chi* *de* *shi-wu*
 eater eat food
 ‘food to eat by an eater’
- d. *chi* *de* *shi-wu*
 eat food
 ‘food to eat’

Structurally speaking, I suggest that the additional PP, VP or NP which surfaces to the left of the V in the thematic non-predicative *de*-constructions in (76) is also base-generated in the specifier of an extended projection of the VP, of which the VP is in the complement, as proposed above. I further posit that the NP argument of the V is base-generated in the complement of the V, then raises to the specifier of an additional *v*P.⁴² The S-structure of (76a) is illustrated in (77).⁴³

⁴² I assume that the movement takes place for case reasons. However, there is room for debate.

⁴³ I assume that *zai shi tang li* realizes terminal nodes within the PP; \emptyset realizes the *v*; *chi* realizes the V.

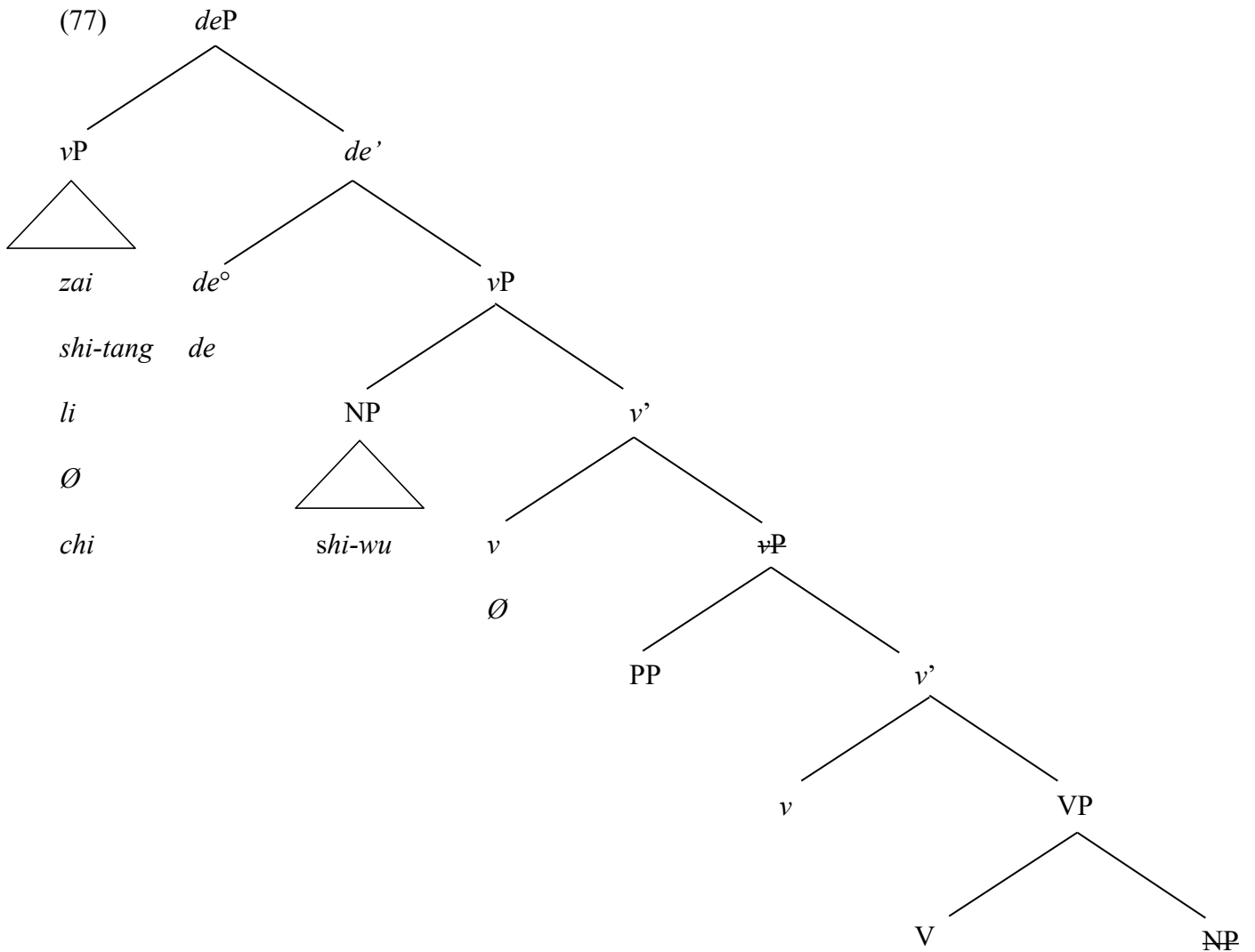

Semantically speaking, I suggest that the interpretation of each thematic non-predicative *de*-construction in (76) may also be captured by making reference to some event, as shown in (78).⁴⁴ I will continue to study event structure in nominal phrases in future research.

⁴⁴ In (78), *x* is a free variable dependent on the context.

- (78) a. $\exists e[\text{eat}(\text{food})(x)(e) \wedge \text{in}(\text{eatery})(e)]$
 b. $\exists e[\text{eat}(\text{food})(x)(e) \wedge \text{use}(\text{tableware})(e)]$
 c. $\exists e[\text{eat}(\text{food})(\text{eater})(e)]$
 d. $\exists e[\text{eat}(\text{food})(x)(e)]$

Compared with thematic non-predicative *de*-constructions, the interpretation of a thematic generic *de*-construction, as exemplified in (79) exhibits more liberty with respect to the event structure involved, as shown in (80).⁴⁵

- (79) a. *zai shi-tang li chi de*
 PREP eatery in eat
 ‘something to eat in an eatery’
- b. *yong shi-ju chi de*
 use tableware eat
 ‘something to eat using some tableware’
- c. *shi-ke chi de*
 eater eat
 ‘something to eat by an eater’
- d. *chi de*
 eat
 ‘something to eat’

⁴⁵ In (80), both x and y are free variables dependent on the context.

- (80) a. $\exists e[\text{eat}(y)(x)(e) \wedge \text{in}(\text{eatery})(e)]$
 b. $\exists e[\text{eat}(y)(x)(e) \wedge \text{use}(\text{tableware})(e)]$
 c. $\exists e[\text{eat}(y)(\text{eater})(e)]$
 d. $\exists e[\text{eat}(y)(x)(e)]$

Because it has been argued that there cannot be an NP argument in generic *de*-constructions (see Section 3.1.3), I posit that the V in thematic generic *de*-construction cannot have an internal argument. To make this happen, I propose that, in the morpho-syntactic derivation of a thematic generic *de*-construction, it is a VP, rather than a V, that is renumerated from the highest vP formed in a morphological derivation in which a Root is categorized by a v° as a vP. In the syntactic derivation, I suggest that the additional PP, VP or NP which surfaces to the left of the V in the thematic generic *de*-constructions in (79) is also base-generated in the specifier of an extended projection of the VP, of which the VP is in the complement, as proposed above. The morpho-syntactic derivation of (79a) is illustrated in (81).⁴⁶ I propose that the de° in thematic generic *de*-constructions is Theme-flavored, such that the nominal phrases may be interpreted as a Theme of the V(P) within them.

⁴⁶ I assume that $\surd\text{eat}$ incorporates into v° (because incorporation or head movement into an x° is mandatory for each xP), and v° is fused into $\surd\text{eat}$ as a result of incorporation (thereby v° is not subject to Vocabulary Insertion). In addition, I assume that *zai shi tang li* realizes terminal nodes within the PP; \emptyset realizes the v; *chi* realizes $\surd\text{eat}$.

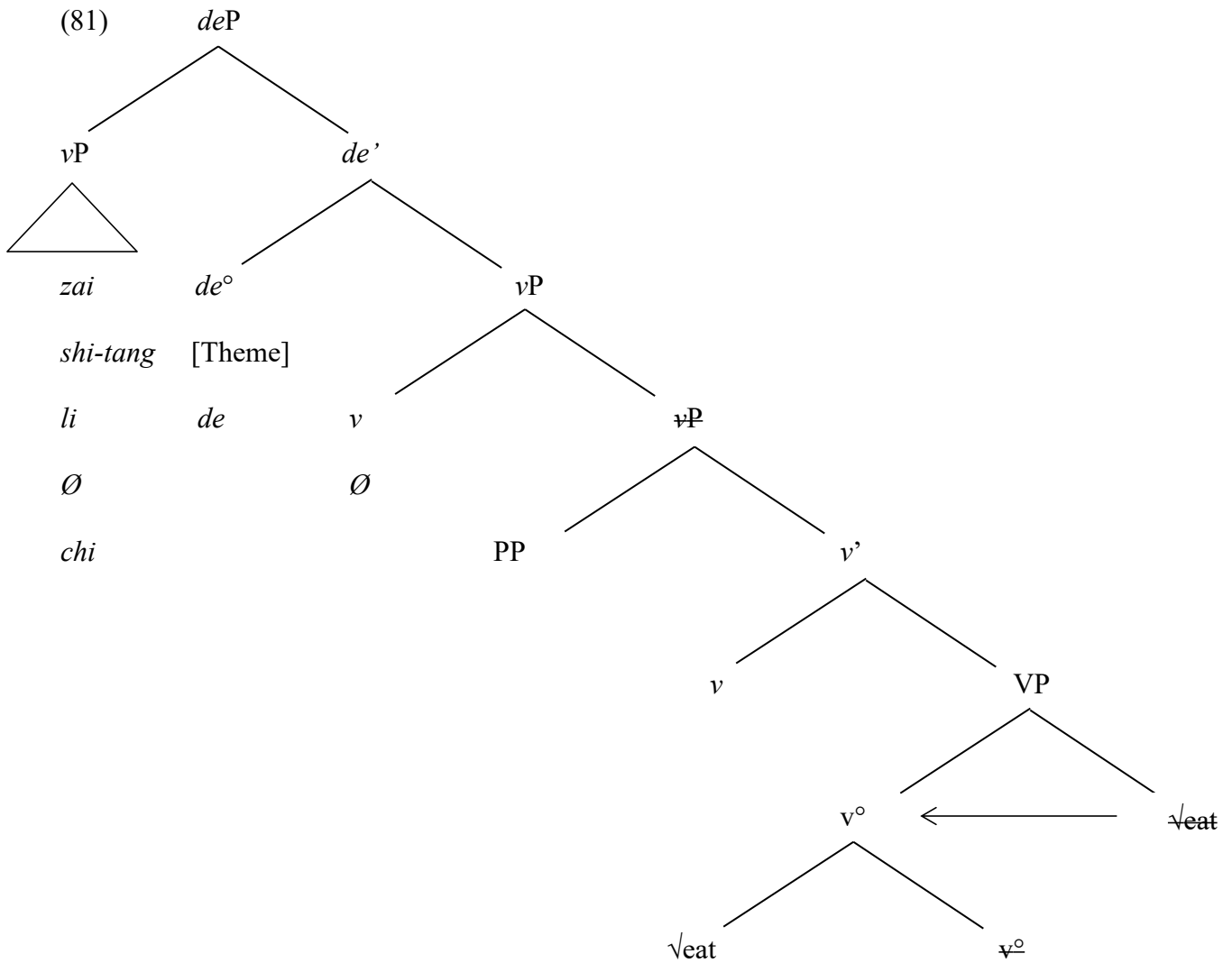

4.1.3 Two types of event-structure nominal compounds

I propose that there are two types of event-structure nominal compounds in Mandarin.

The first type of event-structure nominal compounds in Mandarin are right-head V-N-N compounds where the head N/rightmost element may be regarded as an Agent (82a), a Location (82b) or an Instrument (82c) of the V which is one of the non-head elements of the compound. The other non-head element is a N which may be regarded as the Theme of the V.

- (82) a. *shou* *mu* *ren*
 guard graveyard person
 ‘graveyard keeper’
- b. *shao* *shui* *hu*
 boil water pot
 ‘kettle’
- c. *ban* *gong* *shi*
 do work room
 ‘office’

The second type of event-structure nominal compounds in Mandarin are right-head N-V-N compounds in which the head N/rightmost element may be regarded as the Theme of the V which is one of the non-head elements of the compound. The other non-head element is a N which may be regarded as an Agent (83a), a Location (83b) or an Instrument (83c) of the V.

- (83) a. *jun* *yong* *che*
 military use vehicle
 ‘military-used vehicle’
- b. *wai* *fu* *yao*
 exterior apply medicine
 ‘exterior-applied medicine’
- c. *ping* *zhuang* *shui*
 bottle contain water
 ‘bottled water’

Because the event-structure nominal compounds in (82) may be regarded as the corresponding nominal compounds of non-predicative *de*-constructions where an NP argument is modified by a VP, and the event-structure nominal compounds in (83) may be regarded as the corresponding nominal compounds of thematic non-predicative *de*-constructions where the Agent, Location, or Instrument of the V surfaces to the left of the V, I suggest that both types of nominal compounds are interpreted compositionally. I will leave the structural analysis of event-structure nominal compounds to future research.

So far, every nominal phrase or nominal compound where an event structure is involved is interpreted compositionally. I suggest that nominal phrases and nominal compounds where an event structure is involved are always interpreted compositionally (à la Alexiadou 2009).

4.1.4 Right-headed V-N compounds

In right-headed V-N compounds in Mandarin, the head N may be interpreted as an Agent (84a), a Location (84b), an Instrument (84c), or a Theme (85) of the non-head V. I suggest that right-headed V-N compounds in (84) may be regarded as a subtype of the event-structure nominal compounds in (82), while the right-headed V-N compounds in (85) may be regarded as a subtype of the event-structure nominal compounds in (83). Specifically, the compounds in (84) may be regarded as the corresponding nominal compounds of non-predicative *de*-constructions where an NP argument is modified by a VP, as shown in (84a'), (84b') and (84c'), and the compounds in (83) may be regarded as the corresponding nominal compounds of thematic non-predicative *de*-constructions, as shown in (85a'), (85b') and (85c'). Therefore, I suggest that both types of right-headed V-N compounds, as in (84) and (85), are interpreted compositionally.

$\sqrt{\text{person}}$, respectively; as a result, *shi* is inserted to $\sqrt{\text{eat}}$,⁴⁷ and *ke* is inserted to $\sqrt{\text{person}}$. I also assume that the x° by which each Root is categorized is fused into the Root as a result of incorporation or head movement; consequently, neither x° is subject to Vocabulary Insertion.

(86) a.

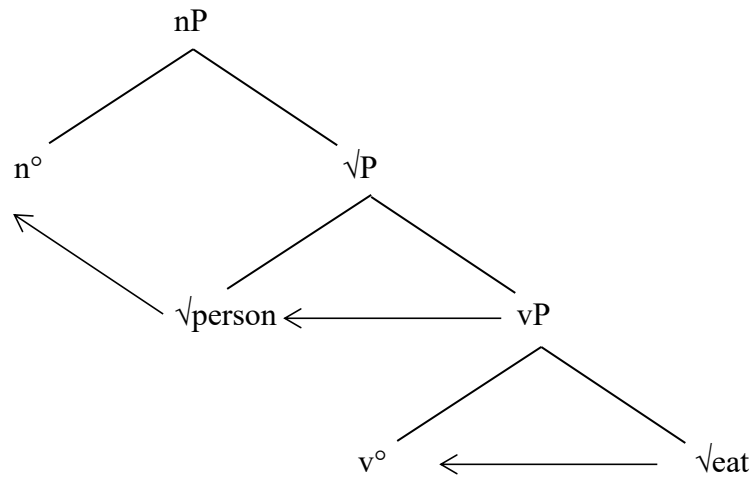

b.

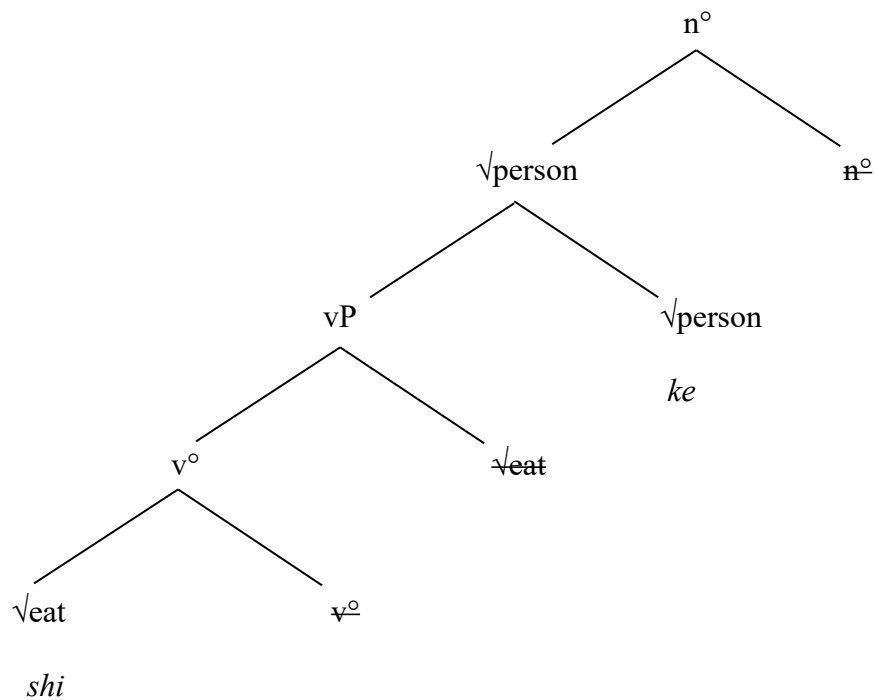

⁴⁷ In addition to *shi*, note that *chi* has been proposed to realize $\sqrt{\text{eat}}$ (see Section 4.1.2). I suggest that this is another case of Root allomorphy (see Section 3.2.4).

4.1.5 Thematic synthetic nominal compounds

Finally, thematic synthetic nominal compounds, which may be regarded as a subtype of synthetic nominal compounds, are formed when a V is nominalized by a Theme-flavored n° , as exemplified in (87a) and (87b).⁴⁸

- (87) a. *shi* *pin*
 eat
 ‘food’
- b. *nian* *tou*
 think
 ‘thought’

I propose that the Root in each thematic synthetic nominal compound is first categorized as a vP by a v° , then recategorized as an nP by a Theme-flavored n° ; consequently, the compound may be interpreted as the Theme of the Root, which may be regarded as a V. In addition to a Root-to- v° -to- n° incorporation and head movement, I suggest that the v° is fused into the n° as a result of head movement such that the v° is eliminated from Vocabulary Insertion. The morphological derivation of (87a) is illustrated in (88).⁴⁹

⁴⁸ The alternation between *pin*, as in (85a), and *tou*, as in (85b), is another case of x° allomorphy (see footnote 73), which I will leave to future research.

⁴⁹ Future research is necessary to explain why it is *shi*, rather than *chi*, that is inserted to $\sqrt{\text{eat}}$ in (88b).

(88) a.

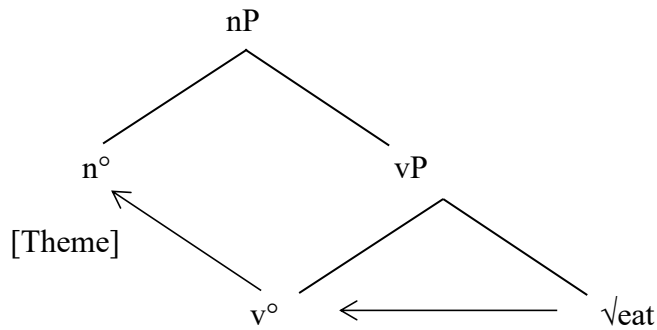

b.

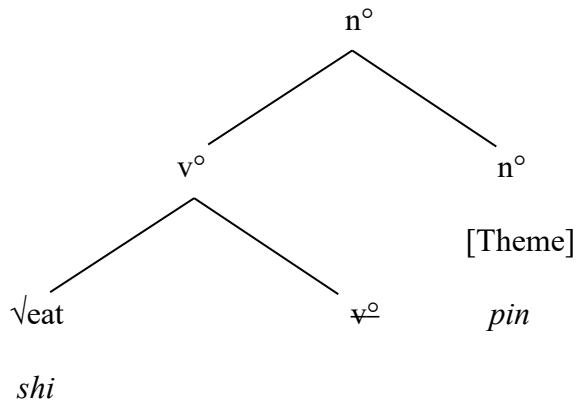

As a side note, it is also possible to form an endocentric nominal compound where the head N is a thematic synthetic nominal compound, as exemplified in (89).⁵⁰

(89) a. *xiao* *chi*
 small eat
 ‘snack’

b. *dan* *juan*
 egg roll
 ‘egg roll’

⁵⁰ I assume that $\sqrt{\text{eat}}$ in (89a) and $\sqrt{\text{roll}}$ in (89b) are recategorized by a phonologically null Theme-flavoured n° . However, it is debatable whether the compounds in (89) may be regarded as endocentric.

4.2 Apposition, Root Merger, and exocentricity

4.2.1 Apposition in non-predicative *de*-constructions

Recall that non-predicative *de*-constructions are recursive; that is, an NP argument may be modified by various XPs, as has been exemplified in (29). Notably, the *de* particle between every two XPs in (29) is mandatory. Nevertheless, there need not be a *de* particle between any two XPs in the non-predicative *de*-constructions in (90) where the NP argument is modified by XPs of the same syntactic category.

- (90) a. *da, ming-liang, kuan-chang de qiu-chang*
 big bright spacious stadium
 ‘big, bright, and spacious stadium’
- b. *bang-qiu-qiu-yuan, lan-qiu-qiu-yuan, zu-qiu-qiu-yuan de qiu-chang*
 baseball player basketball player soccer player stadium
 ‘baseball player, basketball player, and soccer player’s stadium’
- c. *da bang-qiu, da lan-qiu, ti zu-qiu de qiu-chang*
 hit baseball hit basketball kick soccer stadium
 ‘baseball-playing, basketball-playing, and soccer-playing stadium’

I propose that the non-predicative *de*-constructions in (90) are structurally different from cases of recursion (see Section 2.1.5). Specifically, I propose that the XPs (which are specified as APs in (90)) in each non-predicative *de*-construction in (90) are structurally in apposition, which I posit is formed through Merge without projection between two XPs of the same syntactic category, recursively. This means that apposition is an exocentric and flat construction where the XPs are in a symmetric relation. The structural relation among the XPs in (90a) is illustrated in (91).

(91)

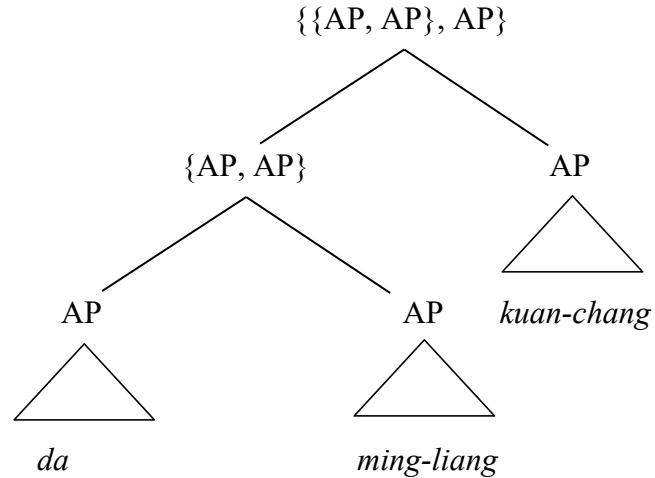

With respect to theta role assignment, I propose that the XPs (which are specified as APs in (91)) jointly assign one theta role to the NP argument; therefore, the theta relation between the NP argument and each of the XPs must be identical. Evidently, XPs which are of the same syntactic category but in different theta relations with the NP argument cannot be in apposition, as shown in (92).

(92) a. **qiu-yuan*, *qiu-chang*, *bang-qiu* *de* *qiu-bang*
 player stadium baseball ball bat

 Intended: ‘player, stadium, and baseball’s bat’

a’. *qiu-yuan* *de*, *qiu-chang* *de*, *bang-qiu* *de* *qiu-bang*
 player stadium baseball ball bat

 ‘player’s stadium’s baseball’s bat’

4.2.2 Exocentric nominal compounds

Exocentric compounds, as opposed to endocentric nominal compounds, are headless. Scalise, Fábregas and Forza (2009) notice that there are limits to the possible categorial combinations of exocentric compounds. For example, exocentric nominal compounds in

Mandarin only consist of five subtypes, as exemplified in (93). However, I suggest that the last two subtypes of exocentric nominal compounds, which are exemplified in (93d) and (93e), may instead be regarded as a subtype of synthetic nominal compound (*cf.* (57a)) and an endocentric nominal compound where the head N is a thematic synthetic nominal compound (*cf.* (89)), respectively. Notably, the remaining three subtypes of exocentric nominal compounds in Mandarin all consist of two elements of the same syntactic category. I will refer to (93a) as an A-A exocentric nominal compound, (93b) as a N-N exocentric nominal compound, and (93c) as a V-V exocentric nominal compound.

- (93) a. *da* *xiao*
 big small
 ‘size’
- b. *jiang* *hu*
 river lake
 ‘vagabond’
- c. *cai* *feng*
 cut sew
 ‘tailor’
- d. *tian* *fang*
 fill room
 ‘second wife (of a widower)’
- e. *ruan* *wo*
 soft lie
 ‘soft sleeper (of a train)’

Scalise, Fábregas and Forza (2009) also notice that the interpretation of exocentric nominal compounds, like (93a), (93b), and (93c), cannot be derived from the meaning of its elements. Therefore, I suggest that the exocentric nominal compounds such as (93a), (93b), and (93c) have an idiosyncratic interpretation. On the other hand, the interpretation of an exocentric nominal compound can also be compositional. For example, the exocentric nominal compounds in (94) are derived from the meaning of its elements.

- (94) a. *fei* *pang*
 fat fat
 ‘obesity’
- b. *ya* *chi* b’. *fu* *mu*
 teeth teeth father mother
 ‘teeth’ ‘parents’
- c. *jiao* *yu*
 educate educate
 ‘education’

According to the single Spell-Out model of morpho-syntax, because Roots must be interpreted compositionally when each of them is embedded in a different xP/domain for non-computational interpretation, I propose that an exocentric nominal compound is interpreted compositionally when each of the two Roots is categorized as an xP (which are specified as an aP in (94a)) separately. Because the two xPs are of the same syntactic category, I further posit that the two xPs are in apposition; that is, the two xPs are merged without projection. I suggest that the xP is then recategorized as an nP by an n°. I further assume that each of the two Roots incorporates into the x°, and each x° is fused into the Root as a result of incorporation. In

addition, the xP which is formed via apposition also incorporates into the n° , and the n° is also fused into the xP. The morphological derivation of (94a) is illustrated in (95). I assume that the VIs *fei* and *pang* are both specified for $\sqrt{\text{fat}}$. The reason why different VIs are inserted to each $\sqrt{\text{fat}}$ and in a specific order are left for future research.

(95) a.

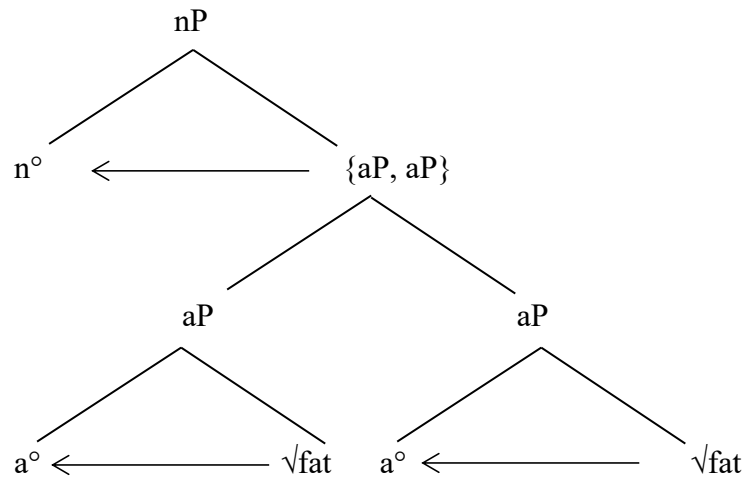

a.

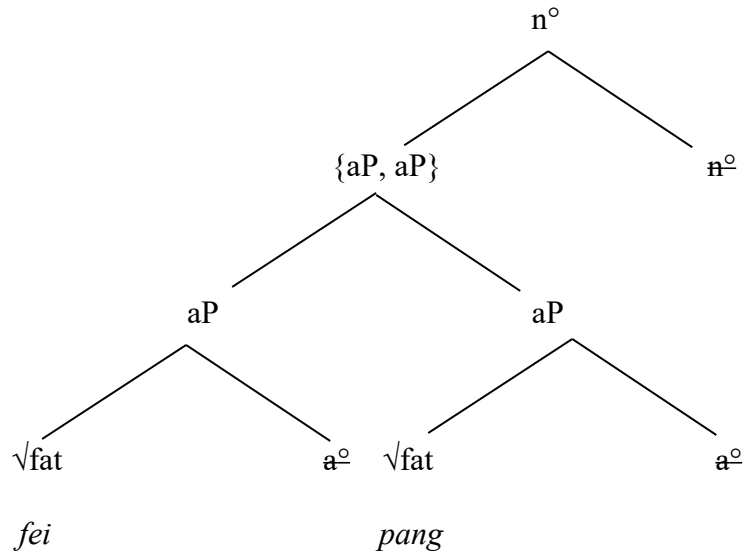

On the other hand, because Roots may be interpreted idiosyncratically if they are embedded in the same xP/domain for non-computational interpretation, which is the first xP which a Root is embedded, I propose that an exocentric nominal compound is interpreted idiosyncratically when both Roots are categorized by the same x° as an xP, prior to the

recategorization of the xP as an nP. To make this happen, I posit that two Roots may be merged without projection, which I will refer to as Root Merger (*cf.* Zhang 2007)). I assume that the result of Root Merger further incorporates into the x°, and the x° is fused into the result of Root Merger as a result of incorporation. In addition, I assume that x°-to-n° head movement also takes place, as a result of which the n° is fused into the x°; Consequently, only the two Roots are subject to Vocabulary Insertion. The morphological derivation of (93a) is illustrated in (96). I assume that the VIs *da* and *xiao* are specified for $\sqrt{\text{big}}$ and $\sqrt{\text{small}}$, respectively.

(96) a.

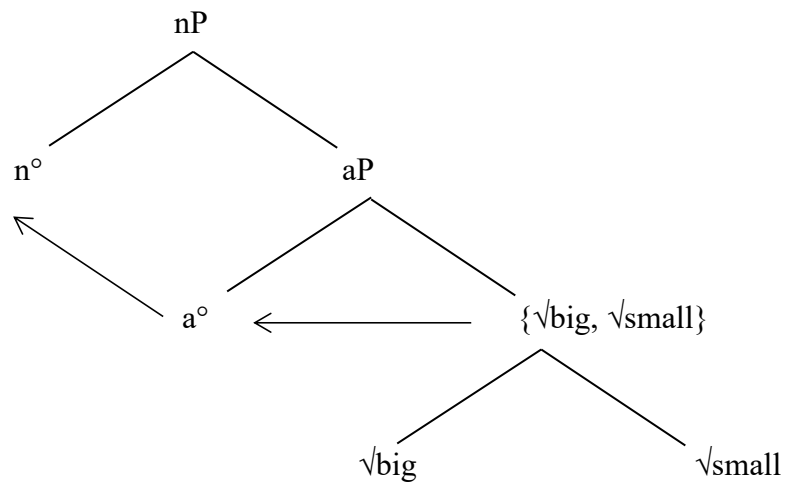

b.

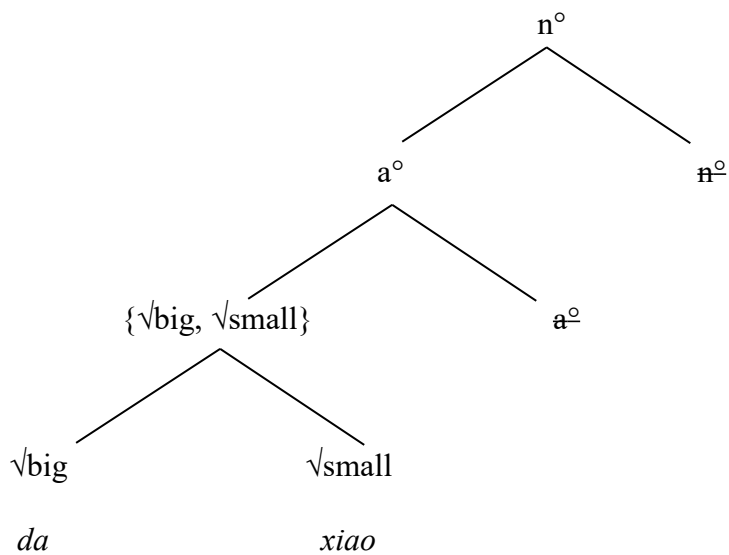

4.2.3 Root Merger as a result of x° selection

Last but not least, it should be noted that there are also limits to the possible semantic combinations of exocentric nominal compounds, despite whether the compounds are interpreted compositionally or idiosyncratically. Specifically, the two Roots in an exocentric nominal compound seem to have either similar⁵¹ or complementary⁵² interpretation.

I suggest that both Roots in an exocentric nominal compound are *s*-selected by the x° which the Root Merger merges with. Therefore, only certain semantic combinations of the Roots may meet the *s*-selection requirement of the x° . Notably, this also means that Root Merger may be understood as a result of x° selection.

It seems that apposition is also limited to certain semantic combinations of the xPs, a line of inquiry I will leave to future research.

⁵¹ e.g., (93b), (94a), (94b), (94c).

⁵² e.g., (93a), (93c), (94b').

Chapter 5 Remarks on the single Spell-Out model of morpho-syntax

In conclusion, through a comparative study of the syntactic derivation of non-predicative *de*-constructions and the morphological derivation of the corresponding endocentric nominal compounds in Mandarin (Chapter 2), and through a comparative study of the syntactic derivation of generic *de*-constructions and the morphological derivation of the corresponding synthetic nominal compounds in Mandarin (Chapter 3), the paper has shown that:

- I. The mismatches between each type of nominal phrases and the corresponding nominal compounds in Mandarin (with respect to LF interpretation and PF Vocabulary Insertion) may be accounted for by three key proposals of the single Spell-Out model of morpho-syntax (which postulates that morphological and syntactic derivations may share one Numeration and one single Spell-Out):
 - I. Renumeration: It is proposed that the highest xP which is formed in each morphological derivation may reenter into the Numeration as an X or XP, thereby the X or XP may be selected in a further syntactic derivation; the highest xP formed in a morphological derivation may also reenter into the Numeration as a Root, in which case the Root would be selected in a subsequent morphological derivation.
 - II. Domain for non-computational interpretation: It is proposed that the first xP in which a Root is embedded is the domain for non-compositional interpretation. Specifically, Roots must be interpreted compositionally when each of them is embedded in a different xP/domain for non-compositional interpretation. On the other hand, Roots may be interpreted idiosyncratically if they are embedded in the same xP/domain for non-compositional interpretation.

- III. Domain for contextual allomorphy: It is proposed that each syntactic terminal node is a domain for contextual allomorphy. Specifically, Roots and x° are realized with phonological content in a cyclic manner if each of them is embedded in a different syntactic terminal node/domain for contextual allomorphy, such that each Root must be realized with a free morpheme; on the other hand, Roots and x° are realized with phonological content freely if they are embedded in the same syntactic terminal node/domain for contextual allomorphy, such that each of the Roots may be realized with a morpheme which is bound to the left or to the right.
- II. Despite the fact that syntactic derivations and morphological derivations differ with respect to how Merge and Move work, similarities between the morphological derivation of each type of nominal compounds and the syntactic derivations of the corresponding nominal phrase may have consequences for the nature of modification and nominalization and their relation to argument structure.

In this chapter, I will provide some concluding remarks on the single Spell-Out model of morpho-syntax and the similarities between the morphological derivation of each type of nominal compounds and the syntactic derivation of the corresponding nominal phrase by making reference to key examples of each type of nominal phrases and the corresponding nominal compounds in Chapter 1.

5.1 Remarks on Renumeration

I began with the proposal that syntactic derivations and morphological derivations may be regarded as different phases of one morpho-syntactic derivation; therefore, morphological derivations and syntactic derivations would share one Numeration. Specifically, it was proposed that morphological derivations proceed to syntactic derivations via Renumeration (see Section 1.4).

It was shown that the highest nP which is formed in the morphological derivation (2b) of an endocentric nominal compound, such as (1a') and (1b'),⁵³ may reenter the Numeration as an NP, thereby the NP may be selected in the syntactic derivation (2a) of a non-predicative *de*-construction, such as (1a) and (1b) (see Section 2.3.1).⁵⁴ In addition, it was shown that the V and its internal argument (NP) in a generic *de*-construction, such as (3a) and (3b), are renumerated from the highest vP and the nP formed in two different morphological derivations, thereby the V and the NP may be selected in the syntactic derivation in (4a) (see Section 3.1.2); in comparison, the Roots which are regarded as a V and its internal argument in a synthetic nominal compound, such as (3a') and (3b'), are selected in the same morphological derivation (3b). It was suggested that the highest xP which is formed in each morphological derivation is no longer a part of the derivation once Renumeration has taken place; on the other hand, the X or XP which is renumerated from the xP would be regarded as a syntactic terminal node, along with other grammatical categories, when it is selected in a syntactic derivation.

⁵³ (1c') and (1d') are also examples of endocentric nominal compounds, the highest nP formed in the derivation of which may reenter into the Numeration as an NP, thereby the NP may be selected in a syntactic derivation, such as (74) or (77), of a non-predicative *de*-construction (72a) or a thematic non-predicative *de*-construction (76a).

⁵⁴ The NP argument in (1c) and (1d) is also renumerated from the highest nP which is formed in some morphological derivation.

5.2 Remarks on LF

I showed that there may be a mismatch between the interpretation of non-predicative *de*-constructions and the interpretation of the corresponding endocentric nominal compounds (see Section 1.3).

On the one hand, it was shown that the interpretation of a non-predicative *de*-construction, such as (7a), (7b), or (7c), is based on the internal structure, i.e., the specifier XP, the head de° , and the complement *aP* of the *deP* (2a). Because the XP and the *de'* are composed by means of modification, the XP is interpreted as a restrictive modifier. In other words, the interpretation of a non-predicative *de*-construction may only be compositional (see Section 2.1).

On the other hand, it was shown that the interpretation of an endocentric nominal compound, such as (7a'), (7b'), or (7c'), is based on the internal structure of the n° which heads the highest nP formed in the morphological derivation of the compound (2b). Therefore, it follows that the Root which is regarded as the non-head element in left-headed N-X compounds (7c') is interpreted as non-restrictive, because it is not embedded in the n° (see footnote 3). In addition, right-headed X-N compounds are interpreted compositionally (7a') when each of the two Roots is embedded in a different xP/domain for non-compositional interpretation (see footnote 1). By contrast, right-headed X-N compounds are interpreted idiosyncratically (7b') when the two Roots are embedded in the same xP/domain for non-compositional interpretation (see footnote 2) (see Section 2.2).

The interpretation of generic *de*-constructions is also based on the internal structure, i.e., the specifier VP, the head de° , and the complement *aP* of the *deP* (4a). Because the VP and the *de'* are composed by means of modification, the VP is also interpreted as a restrictive modifier (Section 3.1). Because the Roots which are regarded as the V and its internal argument are

embedded in different xPs, each of which is a domain for non-compositional interpretation in the morphological derivation of synthetic nominal compounds (4b), they must be interpreted compositionally (Section 3.2).

5.3 Remarks on PF

Third, I showed that there is a mismatch between generic *de*-constructions and the corresponding synthetic nominal compounds with respect to Vocabulary Insertion processes (see Section 1.3).

It was shown that the lack of isomorphism between a generic *de*-construction and the corresponding synthetic nominal compound (8) may indicate that Fusion, which is a frequently used morphological operation by which terminal nodes of a morphological representation may be eliminated from Vocabulary Insertion, has taken place (see Section 3.2.3).

It was further shown that, because the V and its internal argument (NP) in a generic *de*-construction, such as (8a), are renumerated from the highest vP and the nP formed in two different morphological derivations, the two Roots which are embedded in the V and the NP are embedded in different syntactic terminal nodes. Because each of the V and the NP is a domain for contextual allomorphy (4a) and is realized in a cyclic manner, both Roots must be realized with a free morpheme. On the other hand, because the two Roots in a synthetic nominal compound, such as (8a'), are embedded in the same syntactic terminal node/domain for contextual allomorphy (4b) and realized freely, each Root may be realized by a morpheme which is bound to the left or to the right (see Section 3.2.4).

5.4 Remarks on the similarities between morphological and syntactic derivations

Last but not least, despite the fact that syntactic derivations and morphological derivations differ with respect to how Merge and Move work, I showed that the morphological derivation of endocentric nominal compounds (2b) and the syntactic derivation of non-predicative *de*-constructions (2a) exhibit similarities with respect to both D-structure and S-structure. It was suggested that the similarities may have consequences for the nature of modification and its relation to argument structure.

With respect to D-structure, in the morphological derivation of endocentric nominal compounds (2b), the Root which is categorized as an xP is merged with an x° which heads the xP and is asymmetrically c-commanded by the other Root which heads the \sqrt{P} that is categorized as an nP . Similarly, in the syntactic derivation of non-predicative *de*-constructions (2a), the XP is merged with an x which heads an xP and is asymmetrically c-commanded by the NP argument.

With respect to S-structure, in the morphological derivation of right-headed X-N compounds (2b) (see footnotes 1 and 2), the inversion of the two Roots takes place whereby the Root which is regarded as the head of the compound surfaces to the right of the Root which is regarded as the non-head element. Similarly, in the syntactic derivation of non-predicative *de*-constructions (2a), the inversion of the XP modifier and the NP argument also takes place whereby the NP argument is linearized to the right of the XP modifier (see Section 2.3.4).

I also showed that the morphological derivation of synthetic nominal compounds (4b) and the syntactic derivation of generic *de*-constructions (4a) are also similar with respect to both D-structure and S-structure. It was suggested that the similarities may have consequences for the nature of nominalization and its relation to argument structure.

With respect to D-structure, in the morphological derivation of synthetic nominal compounds (4b), the \sqrt{P} is first merged with a v° which heads a vP , which is further merged with an Agent-flavored n° that heads an nP . Similarly, in the syntactic derivation of generic *de*-constructions (4a), the VP is first merged with a v which heads a vP , which is further merged with an Agent-flavored de° that heads a deP .

With respect to S-structure, in the morphological derivation of synthetic nominal compounds where the V surfaces to the left of its internal argument (4b) (see footnote 4), the two Roots do not invert, because \sqrt{P} , in which both Roots are embedded, pseudo-incorporates into the v° . Similarly, in the syntactic derivation of generic *de*-constructions (4a), the V and its internal argument do not invert, because it is the entire VP , consisting of both the V and the NP complement, that is raised to the specifier of the deP (see Section 3.4.4).

In summation, the paper sheds light on the nature of modification and nominalization and their relation to argument structure through a comparative study of the syntactic derivation of non-predicative *de*-constructions and the morphological derivation of the corresponding endocentric nominal compounds in Mandarin, and through a comparative study of the syntactic derivation of generic *de*-constructions and the morphological derivation of the corresponding synthetic nominal compounds in Mandarin. I hope to shed light on the nature of event structure and exocentricity in nominal phrases and nominal compounds in future research (Chapter 4).

References

- Alexiadou, A. (2009). On the role of syntactic locality in morphological processes: the case of (Greek) derived nominals. *Quantification, definiteness and nominalization*, 253-280.
- Alexiadou, A., & Iordăchioaia, G. (2015). Idiomaticity and compositionality in deverbal compounds. In *Handout zum Vortrag auf der Konferenz The 8th Brussels Conference on Generative Linguistics: The Grammar of Idioms (BCGL8), Brüssel 4(5)*.
- Arad, M. (2003). Locality constraints on the interpretation of roots: The case of Hebrew denominal verbs. *Natural Language & Linguistic Theory*, 21(4), 737-778.
- Arad, M. (2005). *Roots and patterns: Hebrew morpho-syntax*. Dordrecht: Springer.
- Baker, M. (1988). *Incorporation. A Theory of Grammatical Function Changing*. Chicago, Illinois: University of Chicago Press.
- Baker, M. (2003). *Lexical categories: Verbs, nouns and adjectives*. Cambridge: Cambridge University Press.
- Bauer, L. (2004). *English exocentric compounds*. New Zealand: Victoria University of Wellington.
- Bobaljik, J. D. (2012). *Universals in comparative morphology: Suppletion, superlatives, and the structure of words*. Cambridge, MA: MIT Press.
- Cheng, L. L. S. (1986). De in Mandarin. *Canadian Journal of Linguistics/Revue canadienne de linguistique*, 31(4), 313-326.
- Cheng, L. L. S., & Sybesma, R. (2009). De as an underspecified classifier: first explorations. *Yuyanxue luncóng*, 39, 123-156.
- Cheung, C. H. C. (2006). Chinese “modifying” DE as a case marker. Paper presented at *WECOL*, 6, 27-29.

- Chierchia, G. (1998). Reference to kinds across language. *Natural language semantics*, 6(4), 339-405.
- Chomsky, N. (1981). *Lectures on government and binding*. Dordrecht: Foris.
- Chomsky, N. (1993). A minimalist program for linguistic theory. In K. Hale & S. J. Keyser (Eds.), *The view from Building 20* (pp. 1-52). Cambridge, MA: MIT Press.
- Chomsky, N. (1995). *The Minimalist Program*. Cambridge, MA: MIT Press.
- Chomsky, N. (2001). Derivation by phase. In M. Kenstowicz (Ed.), *Ken Hale: A life in language*, (pp. 1-52).
- Chomsky, N., & Lasnik, H. (1993). The theory of principles and parameters. *Syntax: An international handbook of contemporary research*, 1, 506-569.
- Davidson, D. (1967). The logical form of action sentences. In N. Rescher (Ed.), *The Logic of Decision and Action* (pp. 81-95). Pittsburgh: Pittsburgh University Press.
- den Dikken, M., & Singhapreecha, P. (2004). Complex noun phrases and linkers. *Syntax* 7, 1-54.
- Grimshaw, J. (1979). Complement Selection and the Lexicon. *Linguistic Inquiry* 10(2), 279-326.
- Grohmann, K. K. (2003). *Prolific Domains: On the Anti-Locality of Movement Dependencies*. Amsterdam: John Benjamins.
- Halle, M. (1997). Distributed morphology: Impoverishment and fission. In B. Bruening, Y. Kang & M. McGinnis (Eds.), *MITWPL 30: Papers at the Interface* (pp. 425-449). Cambridge.
- Halle, M. & Marantz, A. (1993). Distributed Morphology and the Pieces of Inflection. In K. Hale & S. J. Keyser (Eds.), *The View From Building 20* (pp. 111-176). Cambridge, MA: MIT Press.

- Harley, H. (2009). Compounding in distributed morphology. In R. Lieber & P. Stekauer (Eds.), *Oxford Handbook of Compounding* (pp. 129-144). Oxford: OUP.
- Harley, H. (2014). On the identity of roots. *Theoretical Linguistics*, 40, 225-276.
- Huang, S. Z. (2006). Property theory, adjectives and modification in Chinese. *Journal of East Asian Linguistics* 15, 343-369.
- Jackson, S., & Punske, J. (2013). Deriving English compound stress: insights from Distributed Morphology and multiple spell-out. *Linguistic Analysis* 38, 243-74.
- Johnson, K. (2003). Towards an etiology of adjunct islands. *Nordlyd* 31, 187-215.
- Kayne, R. (1994). *The Antisymmetry of Syntax*. Cambridge, MA: MIT Press.
- Kratzer, A., & Heim, I. (1998). *Semantics in generative grammar*. Blackwell.
- Marantz, A. (2001). Words and Things. Ms., MIT & NYU.
- Marantz, A. (2007). Phases and words. In S. H. Choe et al. (Eds.), *Phases in the theory of grammar*. Seoul: Dong In Publisher.
- Massam, D. (2001). Pseudo-incorporation in Niuean. *Natural Language and Linguistic Theory* 19, 153-197.
- Merchant, J. (2017). Roots don't select, categorial heads do: l-selection of PPs may vary by category. Paper presented at *Roots V* in Queen Mary University of London, June 2017.
- Pesetsky, D. (1982). Paths and categories. Ph.D. dissertation. Cambridge, MA: MIT.
- Punske, J. (2016). Compounding. *Language and Linguistics Compass*, 10(8), 382-393.
- Saito, M. & Murasugi, K. (1990). N'-deletion in Japanese: A preliminary study. *Japanese/Korean Linguistics* 1, 258-301.
- Saito, M., Lin, J., & Murasugi, K. (2008). N'-ellipsis and the structure of noun phrases in Chinese and Japanese. *Journal of East Asian Linguistics* 17, 247-271.

- Sato, Y. (2007). Phrasal compounding and the Lexicalist Hypothesis: A multiple spell-out account. Paper presented at *the 2007 International Conference on Linguistics* in Korea, Chung-Ang University, Seoul, Korea, January 20, 2007.
- Sato, Y. (2012). Multiple spell-out and contraction at the syntax-phonology interface. *Syntax* 15, 287-314.
- Scalise, S., Fábregas, A., & Forza, F. (2009). Exocentricity in Compounding. *Gengo Kenkyu* 135, 49-84.
- Simpson, A. (2002). On the status of “modifying” de and the structure of the Chinese DP. In S.W Tang & C.S. Liu (Eds.), *On the formal way to Chinese languages*, CSLI.
- Simpson, J., & Withgott, M. (1986). Pronominal Clitic Clusters and Templates in The Syntax of Pronominal Clitics. *Syntax and semantics*, 19, 149-174.
- Travis, L. D. (1984). *Parameters and effects of word order variation*. Cambridge, MA: MIT Press.
- Zhang, N. N. (2007). Root merger in Chinese compounds. *Studia Linguistica* 61, 170-184.