

The Morphosemantics and Morphosyntax of the Malayalam Verb

by

Amanda Swenson

B.A., Baylor University (2011)

Submitted to the Department of Linguistics and Philosophy
in partial fulfillment of the requirements for the degree of

Doctor of Philosophy in Linguistics

at the

MASSACHUSETTS INSTITUTE OF TECHNOLOGY

September 2017

© Amanda Swenson, MMXVII. All rights reserved.

The author hereby grants to MIT permission to reproduce and to distribute publicly paper and electronic copies of this thesis document in whole or in part in any medium now known or hereafter created.

Author

Department of Linguistics and Philosophy
September 6, 2017

Certified by

Sabine Iatridou
Professor of Linguistics
Thesis Supervisor

Accepted by

David Pesetsky
Professor of Linguistics, Department Head

The Morphosemantics and Morphosyntax of the Malayalam Verb

by

Amanda Swenson

Submitted to the Department of Linguistics and Philosophy
on September 6, 2017, in partial fulfillment of the
requirements for the degree of
Doctor of Philosophy in Linguistics

Abstract

The questions posed and addressed in this dissertation are broadly questions regarding the nature cross-linguistic variation and why languages differ from one another in these particular ways. This thesis focuses on four known points of cross-linguistic variation in the verbal domain: tense, aspect, finiteness and the perfect. It uses data primarily from the Dravidian language Malayalam to explore these questions.

Past work on tense and aspect in Dravidian languages (Amritavalli & Jayaseelan 2005) has claimed that Malayalam, along with the other Dravidian languages, is tenseless. This dissertation, however, shows that Malayalam is empirically different from other tenseless languages and that it does have morphology that encodes tense semantics and a TP. It further examines what have previously been called the two ‘imperfectives’ and argues that the first one is a type of progressive. The second form, is shown to be something between an interative and an imperfective. While the dissertation argues that Malayalam, has tense morphology and a TP, it argues that Malayalam lacks perfect morphology and a PerfP in, minimally, Universal perfects.

The investigation of finiteness focuses on the empirical facts regarding the different non-finite forms in Malayalam and the theoretical implications of these facts. It points out a problem for classifying negation as ‘finite’ versus ‘non-finite’, as has frequently been done (Amritavalli & Jayaseelan 2005, a.o.) and argues that non-finite uses of the *-uka* marker are progressive participles, that Conjunctive Participles are best analyzed as Stump (1985)-style absolutes and that *-athu* gerunds involve nominalization above the TP-level (cf. Borsley & Kornfilt 2000, Baker 2011).

Thesis Supervisor: Sabine Iatridou

Title: Professor of Linguistics

Acknowledgments

This dissertation is the result of a community effort. There is more to be thankful for than is possible to express here, but I will try nonetheless. If I have missed anyone, it was definitely not on purpose and all errors are, of course, my own.

First and foremost, to my friends in Kerala who have taught me so much more than just Malayalam; without you this thesis would not exist, and I would not be the (better) person I am today.

Secondly, while neither of them were officially on my committee, this thesis would have been substantially worse without the extensive input on both the data and the analyses from P. Madhavan and Shijith S. I would have been substantially worse off without all of the support and encouragement I received from them. From Shijith sir I learned to read Malayalam script. You never realize how important reading is until you find yourself somewhere where you can't read.

I am grateful to R. Amritavalli and K.A. Jayaseelan for providing much spirited debate and, in general, making this thesis much better than it ever would have been without their objections and suggestions. Thanks also to Jay, whose work reminded me during my undergrad that I wanted to study Dravidian languages. If not for his work, this thesis might have been a Classics thesis.

Without Sabine Iatridou this thesis might not exist at all. That Sabine became my advisor was somewhat of an accident but it is one that I am immensely grateful for. Sabine has been the perfect advisor with just the right mix of encouragement and tough love and far more confidence in me than I often had in myself. She has been incredibly generous with her time and our meetings and her comments on drafts of this thesis have been invaluable. More than anything, she always cared about me as a person first and a student second. 'Thank you' is very insufficient. This thesis also substantially improved thanks to my other committee members, Kai von Fintel and Norvin Richards. My discussions with them during meetings and their comments on drafts helped make this thesis much better than it would have been otherwise. Norvin has helped me from the beginning of grad school with valuable advice on many

practical details of doing fieldwork. I have greatly benefited from Kai's professional advice and understanding and appreciation of who I am. I frequently have come for meetings and classes with Kai excited about a piece of data in Malayalam or some other another language and left with a new understanding of why that data piece should make me excited about English too.

My time at MIT and this thesis was also greatly enriched by the other faculty members. Shigeru Miyagawa, though not on my committee, has played a considerable role in my graduate career. Thanks for always believing in me, encouraging me, enthusiastically discussing the intricacies of *thaan* with me, and teaching one of my favorite MIT classes on agreement and Japanese. Adam Albright was on the committee for the generals paper that developed into this dissertation. His comments were invaluable and one of their results is chapter 4 of this thesis. He, along with David Pesetsky, helped me get started on the morphology project that was the beginning of this thesis. In addition to teaching a stimulating morphology class, David has given me valuable feedback on chapter 3 of this thesis, as well as on my work on *thaan*. Roger Schwarzschild, though he came to MIT at the end of my time here, helped me think more clearly about parts of chapters 3 and 4. Noam Chomsky reminded me at a critical point during thesis work to look beyond surface appearances in the data to get to the heart of the matter. I admire Irene Heim for her humility and ability to graciously tell you how to make things better. From her I learned the importance of going 'deep' into a language. Donca Steriada also played an important role in my graduate career for encouraging me, during a particular moment in my first year when I was very discouraged, not to give up working on Dravidian languages. I really enjoyed TAing for Michel DeGraff, from whom I learned a great deal about teaching. Our conversations about Haitian Creole and education and language policy, as well as his professional advice, have greatly enriched my MIT experience. I also benefited from conversations with Noah Constant and from his class on information structure, which was my other favorite class at MIT. Being around Danny Fox has reminded me of the importance of childlike joy in working on linguistics puzzles. I also am grateful to have taken classes with and had discussions with Martin Hackl, Ken Wexler,

Maziar Toosarvandani, Michael Kenstowicz, and Ben George during my time at MIT.

This thesis has also greatly benefited from discussions with Athulya Aravind, Enoch Aboh, Bronwyn Bjorkman, Miriam Butt, Seth Cable, Jessica Coon, Veneeta Dayal, Jasmine Maria G., Keerthana Gopinathan, Patrick Grosz, Ishani Guha, Heidi Harley, Despina Ikonomou, Gouthaman K.J., Paul Marty, Mythili Menon, Sarah Murray, Roumi Pancheva, Pritty Patel-Grosz, Minu Sara Paul, Pooja Paul, Paul Portner, Abdul-Razak Sulemana, Peter Svenonius, Sergei Tatevosov, Madhu V. and the participants of TripleA 3, FASAL 6 and 7, the 42nd and 43rd All Indian conferences of Dravidian Linguistics, the EFLU seminar series, FTL at UiO, MIT Ling-lunch, and the MIT-ESSL/LaqLab. Yangchen Roy deserves special thanks for helping me get the Gopalkrishnan thesis and for enthusiastically discussing the Malayalam data and possible analyses with me.

I am also grateful to Mala Ghosh for her encouragement and for supporting my fieldwork with MISTI/MIT-India internships. Additional support for my fieldwork trips was also provided by Ken Hale grants for linguistic fieldwork.

Any shortcomings or errors in the data or analysis are my own responsibility.

Thanks to Jen Purdy, Matt Sikorski, Christine Graham, Mary Grenham and Chris Naylor for their help with practical matters throughout my time at MIT. Thanks to Bev Stohl for being so encouraging.

Thanks to my friends, officemates, and classmates at MIT from whom I learned a lot about linguistics and life and with whom I had a great time: Abdul-Razak, Anouch, Athulya, Despina, Erin, Gretchen, Isa, Isaac, Ishani, Juliet, Mar, Marie, Masako, Mia, Michelle, Paul, Snejana, Suyeon, and TC.

Many other friends outside of the department have made my time in Boston good (a non-exhaustive list): Mary, Camille, Mina, Natalia, Christina, Caleb, Lina, John, Tiara, QT, Mark, Guan-Ting, Marcus, Emily, Anya, Nathan, Hannah, Ming, Yukkee, Gerald, Steph, Heather, Michelle, Ange, Adam, Diana, Parki, Dilpreet, Gao Yu, Ming, Nayoon, Yukari, Claire, Amanda, Nahomy, Christina, Elizabeth, Julli, Lindsay, Laura, Theresa, Juliette, Rachel, Vera, Clizia, Salome, Ambrose, Feiby, and Maurine. Thanks to Erica, who has always been there over the last 10 years, and

Lizzy aunty, who gave the first Malayalam judgments. Thanks to George, who so graciously helped me improve my fieldwork skills, generously answered my tedious questions about the ins and outs of Malayalam with enthusiasm, and supported me during the difficult parts of grad school. Thanks to Revanth, Sam and Kiran for answering my questions about Telugu and for their friendship.

Thanks also to all my friends in Hyderabad for sharing their work with me, having great discussions about linguistics and non-linguistics topics, helping with practical details and in general, making my time there great.

Many thanks to Jessica, Rafa, Austin and Caleb for their hospitality and encouragement in the final stretch. Thanks also to Graeme, Leasa, Pilar, Damon, Susan, Karl, Oleksiy, Pam, Judy, Ann, Matt, and Simone for being great colleagues. Thanks to my LIN 302 students for comments on parts of the material in chapters 1 and 5. Thanks especially to David, Mari, Levan and Andria for their friendship.

I never would have come to grad school had it not been for my undergraduate advisor, Lydia Grebenyova, who was excited to work with me when I came and told her that I wanted to study the syntax of an Indian language. Thanks for being a great teacher, mentor and for having so much faith in me. Her devotion to her students and passion for undergraduate research is unparalleled. Thanks to my other teachers during my undergrad at Baylor for encouraging my interest in linguistics and, in general, broadening my horizons and encouraging me to learn.

My eighth-grade English teacher Mrs. Andersen was the first person to teach me how to draw syntax trees and explain to me why we need DPs. Thanks to my high school English teacher Mrs. Coleman for supporting my desire to learn about grammar in a more sophisticated way and for allowing me to research the ‘unusual’ topics I wanted to for my English papers. Thanks to Senora Holmes and Mme. Rimestad for tirelessly bearing with my questions about why Spanish and French, especially the verbs, work the way they do. Thanks also to Sartha aunty, Vinay uncle and Usha aunty for helping me with my first attempts at fieldwork and patiently answering my questions about Hindi, teaching me about Indian culture and for generally being encouraging.

My thanks to my family and friends outside of Boston for their support and encouragement throughout grad school. The list would be too long, and I am too tired at this point, but you know who you are.

Finally, none of this would have been possible without my parents and sister. Thanks for always being there and loving me unconditionally. From my grandma and granddaddy I learned more than I could ever express about unconditional love and the true meaning of success.

For now we see in a mirror, dimly, but then face to face.

Contents

1	Introduction	17
1.1	Introducing the Puzzle	17
1.1.1	Tense, Aspect & the Perfect	20
1.1.2	Auxiliaries, ‘do-support’, light verbs and Serial Verb Constructions	22
1.1.3	Non-finite forms	23
1.2	Sneak Peek	24
2	A Tense, Aspect and Perfect Primer	29
2.1	Basic assumptions about tense, aspect and the perfect	30
2.1.1	Syntactic and morphological component	30
2.1.2	Semantic component	34
2.2	What is a tenseless language?	56
2.2.1	‘No overt morphology’ camp	57
2.2.2	Tensed account for tenseless language	57
2.2.3	Tenseless accounts for tenseless language	59
2.2.4	Accounts for tenseless languages that are of controversial status	66
2.2.5	‘No TP’ camp	69
2.3	Chapter summary	70
3	Tense & Aspect in Malayalam	73
3.1	A complex puzzle	78
3.2	Malayalam is not a tenseless language	80

3.2.1	Applying the tests to the imperfective morphologies	81
3.2.2	Applying the tests to the past morpheme	87
3.3	The beginnings of a tensed account	92
3.3.1	Interim summary	99
3.4	The difference between the two ‘imperfectives’	99
3.4.1	An intuition about the semantics for <i>-unnu</i>	107
3.4.2	Interim summary	115
3.5	<i>Undu</i> vs <i>aanu</i> : The different ‘being’ verbs in Malayalam	117
3.5.1	Equative, predicative, existential and possessive contexts	118
3.5.2	Location, psychological and medical predicates	121
3.5.3	The immediacy requirement: towards an account for <i>undu</i> and <i>aanu</i>	132
3.6	Chapter summary	141
4	Non-finite clauses in Malayalam	143
4.1	‘Finite’ and ‘non-finite’ negation	145
4.1.1	Problems for a finite based account	146
4.1.2	Possible alternate analysis	149
4.1.3	Interaction of negation and modals	152
4.2	Non-finite uses of <i>-uka</i> marked verbs	154
4.3	Conjunctive/Adverbial Participles	160
4.3.1	Introducing the puzzle/controversial status	162
4.3.2	Properties of Conjunctive Participle Constructions	166
4.3.3	Conjunctive Participles as modified Stump (1985)-style adjuncts	174
4.3.4	Interim summary	184
4.4	Nominalizations in Malayalam	186
4.4.1	Are <i>-athu</i> nominalizations gerunds?	186
4.4.2	Comparison of Malayalam nominalizations & relative clauses	190
4.4.3	Adjectives as relative clauses in Malayalam	197
4.5	Chapter Summary	199

5	The Perfect in Malayalam	203
5.1	Introducing the puzzle	205
5.2	<i>kondu</i> is not a progressive participle; it is a lexical aspect modifier . .	207
5.2.1	<i>kondu</i> and predicate type	207
5.2.2	Why use <i>kondu</i> in Universal perfects?	212
5.3	<i>irikk-</i> is not a perfect auxiliary; instead it has three functional, non- perfect uses	214
5.3.1	<i>irikk-</i> as a viewpoint aspect auxiliary	215
5.3.2	Light Verb use of <i>irikk-</i>	218
5.3.3	<i>irikk-</i> as ‘do’-support	223
5.4	Implications for compositionality	226
6	Conclusion	237
A	Additional differences between <i>-uka</i> and <i>-unnu undu</i>	241
B	On the choice of <i>-u</i> or <i>-i</i>	245

List of Tables

2.1	Tense features and their phonological outputs in English	31
3.1	Hypotheses for the meanings of <i>-unnu</i> and <i>-u</i>	78
3.2	Full tense/aspect paradigm for <i>var-</i> ‘come’	79
3.3	Tense/aspect forms of <i>irikk-</i> ‘sit’	80
3.4	Tense/aspect paradigm for <i>var-</i> ‘come’	81
3.5	Features associated with English tense/aspect auxiliaries	96
3.6	Tense/aspect paradigm for <i>var-</i> ‘come’	96
3.7	Features associated with Malayalam tense/aspect auxiliaries (Version 1)	98
3.8	Features associated with Malayalam tense/aspect auxiliaries (Version 2)	116
3.9	Comparison of the Spanish and the Malayalam copulas	121
3.10	Copulas in location predicates in Malayalam and Spanish	126
3.11	Summary of the uses of the two copulas in Malayalam	131
4.1	Possible Readings for Different Event Types in Absolutives	177
5.1	Options for expressing Universal perfects in Malayalam	215
5.2	Perfects & the Principle of Compositionality	233

Chapter 1

Introduction

1.1 Introducing the Puzzle

The questions posed in this dissertation are broadly the questions of what type of cross-linguistic variation occurs and why languages differ from one another in these particular ways. This thesis focuses on four known points of cross-linguistic variation in the verbal domain: tense, aspect, finiteness and the perfect. It explores these puzzles using data primarily from the Dravidian language Malayalam. In the course of the investigation it will be shown that Malayalam, though very different than English and other related languages, is, in fact, built from the same building blocks as these languages. The evidence for this claim will come from the ‘peculiar’ looking behaviors of Malayalam.

One way languages can vary is with respect to the type of morphology they have. For example, languages can have no tense morphology (Smith et al. (2003), Smith et al. (2007) for Navajo; Smith and Erbaugh (2005) and Lin (2003), Lin (2006), Lin (2010) for Mandarin; Mucha (2012), Mucha (2013) for Hausa; Bohnemeyer (2009) for Yucatec Maya; Tonhauser (2011) for Paraguayan Guarani; Shaer (2003) and Bittner (2005) for Kalaallisut, Matthewson (2006) for St’at’imcets, a.o.) or they can have a multiplicity of tense forms, which make finer grained distinctions than the two to three tenses common in languages like English (Hayashi (2011) and Hayashi and Oshima (2015) for South Baffin Inuktitut; Cable (2013) for Gikuyu; Bochnak and

Klecha (2015a), Bochnak and Klecha (2015b) for Luganda; Mucha (2015), Mucha (2017) for Medumba; Mucha and Fominyam (2017) for Awing, a.o.).

Languages also differ with respect to their morphological resources for expressing the different readings of the perfect. Some languages, such as Turkish, do not have any special perfect morphology; instead, they just use simple tense forms. Others, like Modern Greek (Iatridou et al. 2003) and Georgian, have perfect morphology to express the Existential perfect but not the Universal perfect. Languages like Bulgarian use both dedicated perfect morphology and simple tense forms (Iatridou et al. (2001), Pancheva (2003)). Others, such as English, allow only dedicated perfect morphology and prohibit simple tense forms.

Another area in which languages differ is in how they encode the notion of ‘finiteness’. Languages vary regarding how forms or clauses are classified as ‘finite’ versus ‘non-finite’. Some classify forms based on the presence or absence of one or more of the following types of morphology: tense, mood, agreement, evidential, or honorific (Nikolaeva 2010). A number of other ways of classifying finiteness also exist. In general, the nature of ‘finiteness’ is not well understood (Nikolaeva (2010), McFadden and Sundaresan (2014)).

All of these areas of morphological variation have syntactic correlates: with tense, TP and with the perfect, PerfP. Finiteness also has a syntactic dimension to it. In the early GB-era, IP was the syntactic locus of finiteness and hosted all inflectional morphology. Later work in GB and in Minimalism (beginning with Pollock (1989)) has replaced the early GB-era IP with a series of functional heads which host the different types of inflectional morphology and are responsible for the respective semantics of voice, aspect, perfect, tense, mood, etc. Work in the cartographic tradition (beginning with Rizzi (1997)) has suggested that finiteness deserves its own projection, FinP, low in the CP-level. As such, the question of variation is not simply a morphological one.

This fact raises questions regarding the mapping between the morphology and syntax. For example, if a language lacks a visible exponent of a certain morpheme or set of morphemes, does this mean that it lacks the corresponding syntactic projec-

tion? The answer need not be affirmative. One possibility is that the language has (a) corresponding covert morpheme(s), which appear in the respective syntactic projection. However, it is also a logical possibility that a language could lack a morpheme or a set of morphemes, covert or overt, and, in turn, also lack the corresponding syntactic projection. Another possibility might be that the projection is present in the syntax though it has no (co)overt morphology present in it. If a language chooses the second option, this raises questions about the other implications of the absence of the syntactic projection. For example, if a language were to lack a TP, how would this affect case licensing, licensing an EPP feature, nominalization, finiteness or binding in that language?

The second option also raises questions for the mapping of the morphosyntax and semantics. For example, if a language lacks a set of morphology and the corresponding syntactic projection, what other mechanism does it use to get the semantics? Such a language would need to have other, non-morphosyntactic ways of indicating these relationships. The literature on tenseless languages has already suggested that, in addition to morphosyntactic features on T, languages can use information encoded in the semantics of lexical and/or viewpoint aspect or pragmatic principles to obtain temporal information. The specifics of the alternate mechanism can vary from language to language (as the tenseless literature shows). One reason for this variation is that languages can differ in the exact semantics a particular feature encodes. One example of this can be found by comparing the English and German present tenses (Pancheva & von Stechow 2004). The puzzle for each language is then two-fold: what is the alternate mechanism being used and what language internal factors along with universal principles cause that mechanism to be selected?

On the flipside, if a language has more specifications for a certain category, questions regarding the nature of the morphology-syntax mapping also need to be asked. For example, does each individual piece of morphology license its own syntactic projection or are there just more featural specifications possible for certain heads in certain languages? If the first option is chosen, is there a fixed order to these heads language internally and cross-linguistically? Relatedly, do all these heads have to project in all

languages? Questions of these sorts have been entertained in the cartographic literature (beginning with Rizzi (1997)) and also in work by Ritter & Wiltschko (2005, 2010, 2014), a.o. No matter the specifics of the morphosyntax in a given language, the pieces involved in any account that might be presented should be compositional (Frege 1884).

This dissertation explores these questions in the context of the Dravidian language Malayalam. For tense, the focus in this dissertation will be on what the criteria should be for discerning whether or not a given language is tensed or tenseless, as Amritavalli & Jayaseelan (2005) have controversially claimed that Malayalam is a tenseless language. The dissertation will argue that Malayalam has both tense morphology and a TP. With respect to aspect, it will be shown that Malayalam uses a large range of lexical aspect modifying markers and light verbs, in addition to having nuanced variations in its viewpoint aspect system. The examination of the perfect will investigate whether or not Malayalam has a PerfP and perfect morphology. Despite superficial evidence that it does, the claim ultimately will be that Malayalam in fact lacks both perfect morphology and a PerfP, at least in Universal perfects. The investigation of ‘finiteness’ in Malayalam will not focus on what constitutes ‘finiteness’ in Malayalam, but rather on the distributions of the different ‘non-finite’ forms in Malayalam. The next three subsections provide some additional information about the larger theoretical significance of this investigation and how the ‘peculiarities’ of Malayalam, in fact, show that it is built using the same ‘atoms’ as other languages.

1.1.1 Tense, Aspect & the Perfect

The existing work on tense, aspect and the perfect in Malayalam focuses almost exclusively on whether or not Malayalam has a TP in its clausal structure and what the role of the morphology is in drawing this conclusion. On one side, Amritavalli and Jayaseelan (2005), Amritavalli (2014), and Jayaseelan (2014) claim that Malayalam lacks tense morphology and a TP. This is not a priori impossible as a diverse number of languages have been argued to lack tense morphology and/or a TP cross-linguistically, as discussed above.

However, this position is a controversial and novel claim for Malayalam. Grammars have long claimed that Malayalam has tense morphology (Gundert 1851, Caldwell (1856), Peet (1860), Frohnmeyer (1913), Raja Raja Varma (1917), Asher and Kumari (1997), a.o.) and Babu and Madhavan (2003) and Menon (2011) have argued in favor of Malayalam having a TP in the syntax. This thesis will argue, along with the grammars and Hany Babu & Madhavan (2003) and Menon (2011) that Malayalam has tense morphology. It will also show that Amritavalli & Jayaseelan’s arguments that Malayalam lacks a TP are not conclusive. It will then argue that Malayalam and English both have roughly the same morphological tense and viewpoint aspect features in the syntax. This explains why the same pattern of auxiliary usage is found in both languages.

While this thesis argues that Amritavalli & Jayaseelan are wrong in calling Malayalam a tenseless language, they are right in their intuition that the tense/aspect/perfect system in Malayalam, is, in some ways, quite different from that of English and other related languages. For example, this thesis will show (following Hany Babu 2006) that the so called ‘imperfective’ viewpoint aspect in Malayalam is different from that of Italian and Hindi in that it allows accidental generalizations, among other things. It will build on the intuitions in Hany Babu (2006) and extend them beyond the ‘generic’ reading to the event-in-progress reading. It will suggest that, contra Hany Babu (2006), a unified account of the two readings is merited and sketch the intuition for what such an account might look like.

It will also argue that Malayalam uses a number of morphemes to modify lexical aspect and the vP domain. For example, it uses light verbs (in the sense of Butt 2010) to provide additional information about the event and lexical aspect markers to modify the lexical aspect of predicates.

Turning to the perfect, the dissertation argues that Malayalam lacks a PerfP and dedicated perfect morphology in, minimally, the Universal reading of the perfect. Instead, it makes use of either simple tense forms or viewpoint aspect along with the lexical aspect modifier morpheme and an auxiliary to express what is semantically equivalent to the perfect in other languages. As such, while the elements that create a

(Universal) perfect meaning are quite different in Malayalam and English, nonetheless Malayalam adds further typological support to Iatridou et al. (2003) and Pancheva (2003, 2013)'s proposal that lexical aspect and viewpoint aspect determine the types of perfect a language can have. That a language without perfect morphology might more heavily rely on the aspectual resources it has is unsurprising given the findings in the tenseless literature.

1.1.2 Auxiliaries, ‘do-support’, light verbs and Serial Verb Constructions

In the examination of tense, aspect and the perfect, the thesis will explore the role of auxiliaries, ‘do-support’, light verbs and what have been called ‘Serial Verb Constructions’ in Malayalam and situate them with respect to the cross-linguistic data. Generally these terms are not always well defined, and often times it is not clear how the phenomena labeled with these terms differ from one another.

This dissertation will refer to auxiliary verbs as those verbs which are present in the syntax specifically to rescue stranded features (Bjorkman 2011, under review). It will be shown that Malayalam has the same feature configurations as English does in the cases of sentences marked with just viewpoint aspect and tense. This will result in the same pattern of auxiliaries in the two languages. It will further consider questions of auxiliary selection in Malayalam, which has three main auxiliary verbs: *undu*, *aanu* and *irikk-*.

The auxiliary *irikk-*, in addition to its function as a viewpoint aspect auxiliary, has two other functional uses: a light verb use and a ‘do’ support use. ‘Do’-support, on the other hand, occurs when V and v are pronounced separately from one another (Bjorkman 2011, under review). The term ‘light verb’ will be used in the narrow sense of Butt (2010). What have been called Serial Verb Constructions in Malayalam will be examined and instead argued to be absolutive constructions as defined by Stump (1985).

It will be shown that Malayalam has multiple verbs that can be used for ‘do’

support. The thesis will suggest that Aboh (2009, 2016) may be on the right track in arguing that Serial Verb Constructions and auxiliaries may be governed by a common principle and need to be more carefully explored cross-linguistically.

1.1.3 Non-finite forms

A second question this thesis will focus on has to do with the poorly understood notion of ‘finiteness.’ The focus in the dissertation will be not so much on what counts as finiteness in Malayalam but on the behavior of three different ‘non-finite’ forms.

Nikolaeva (2010) and McFadden & Sundaresan (2014) provide useful summaries of the way the term ‘finiteness’ has been used. Broadly speaking, in the descriptive literature, especially when following the Latin grammatical tradition, ‘finiteness’ is often a term linked to verb forms and not clauses. These finite verb forms are inflected for tense, agreement, mood, etc. (as discussed above). Forms that do not meet these requirements, such as participles, gerunds, and infinitives are then called ‘non-finite’ forms.

Nikolaeva (2010) suggests that what makes a non-finite clause non-finite is that it is not wholly ‘verbal’, but rather it is of a mixed nature. Gerunds and infinitives are claimed to have properties of both verbs and nouns (Comrie (1976), Koptjevskaja-Tamm (1993), also see Abney (1987), Baker (2011)) while participles are claimed to have the properties of both verbs and adjectives (Haspelmath (1994)). An additional question raised here then is, what is meant by terms like ‘noun,’ ‘verb’ and ‘adjective’? This is not a trivial question and has been answered in a number of ways (cf. Chomsky 1970, Jackendoff 1977, Baker (2003), a.o.).

In more recent work in both the generative and non-generative tradition ‘finiteness’ has been defined as a clausal property, not a property of individual forms. In this way, finite clauses are defined as those that can form independent sentences by themselves, have overt subjects and create locality restrictions for binding. However, as both Nikolaeva (2010) and McFadden & Sundaresan (2014) note, even a clausal-based definition of finiteness runs into problems when faced with a wider range of languages.

A few examples include phenomena like infinitives that show agreement in European Portuguese and allow overt subjects Raposo (1987), Tamil participle clauses and Irish, Tamil, Malayalam and Sinhala infinitival clauses that allow both an EC and overt NP subject (Sundaresan & McFadden 2009), and the Icelandic long-distance reflexive which allows long-distance binding only out of subjunctive clauses (Hicks (2009), Reuland (2001), Sigurdsson (1991)).

As one can see, the picture here is still messy. If the intuition that non-finite forms are somehow ‘mixed categories’ is right, then the question of better defining ‘non-finiteness’ stands at the heart not only of better understanding the property of clauses but also of understanding the most basic building blocks of language. This discussion of what categories are universal and how they are defined is especially interesting here in that Malayalam has been argued to lack one of the basic building block categories, namely lexical adjectives (Menon 2016, Menon and Pancheva (2014)).

1.2 Sneak Peek

The method for exploring the puzzles described above will be to scrutinize the use of each of the relevant morphemes to provide new insights as to their meanings. The moving parts that will be examined in the course of the thesis are given in (1). Chapter 2 provides an overview of the basic grammar for tense, aspect and the perfect assumed. It will also contain a brief review of the literature on tenseless languages.

- (1) a. *-u/i*
- b. *-um*
- c. *-unnu*
- d. *-uka*
- e. *aanu*
- f. *undu*
- g. Conjunctive/Adverbial participles
- h. *-athu* nominalization

- i. *-kondu*
- j. *-ittu*
 - (i) functional uses of *irikk-*

Chapter 3 begins the main arguments of the thesis. The overarching theme of this chapter is the morphosemantics and morphosyntax of tense and aspect in Malayalam. It begins with an overview of Amritavalli & Jayaseelan’s (2005) proposal that Malayalam, along with the other Dravidian languages, is tenseless. It is then pointed out that it is possible to accept Amritavalli and Jayaseelan’s assertion that ‘finiteness’ is not linked to tense in Dravidian without accepting their claim that Dravidian languages lack tense morphology and a TP. The first part of this chapter highlights the difficulty of the tense-aspect puzzle in Malayalam and then shows that while Amritavalli & Jayaseelan could be right about what counts as finiteness/anchoring in Malayalam, the assertion that Malayalam is tenseless is not empirically supported. The first half of this chapter shows that Malayalam is empirically different from other tenseless languages and does have morphology that encodes tense semantics, making it a tensed language for those in the ‘no overt morphology’ camp.

The second section provides a sketch of an analysis for tense and aspect in Malayalam. It argues that Malayalam has a TP with tense features, which spell out as tense morphemes when nothing intervenes between the verb and T (a la Bjorkman 2011, Bjorkman (sion)), and as auxiliaries when another active head intervenes. This explains the distribution of auxiliaries and the obligatory nature of predicative copulas in Malayalam. Having a TP makes Malayalam a tensed language for those in the ‘no TP’ camp. The argument that Malayalam is a tensed language constitutes the first part of the chapter.

The second part of the chapter took a closer look at the semantics of the *uka* and *unnu* forms, (1-c)-(1-d), which have been generally called the two ‘imperfectives’. It will be argued here *uka* is an intensional progressive while *unnu* is used when a situation involves multiple, temporally connected episodes taking place within close succession, like an iterative. But it differs from an iterative in that it is necessary that

these iterations take place within another interval, *i*, in the actual world. Because this interval has or gets the subinterval property, it results in accidental generalizations over these episodes. Because the Topic Time is contained in the Situation Time, this gives a Klein (1994) progressive meaning while the ‘generalizing’ step that gives the progressive meaning also results in a report on the state of things in the actual world, i.e. the ‘generic’ use of *unnu*. This results in it having the appearance of an imperfective.

Finally, the last section turns to the question of why Malayalam uses different copulas to realize the stranded tense features in the progressive and the imperfective. The main conclusion is that the *undu* copula, (1-f), is the existential copula, also used to express possession. When it is used in location, psychological and medical predicates, it expresses immediacy (cf. Patel-Grosz’s (2016) immediacy requirement in certain negative imperatives cross-linguistically). The copula in (1-e), *aanu*, is argued to be the elsewhere copula.

Chapter four’s main focus is to provide the empirical facts regarding the different non-finite forms in Malayalam and the theoretical implications of these facts. The first section provides an overview of what have been called ‘finite’ and ‘non-finite’ negation in Malayalam and how they have been used as a diagnostic for finiteness. It then shows that ‘finiteness’ does not seem to be the governing factor in determining the use of negation in Malayalam and suggests what an alternative account might look like. The remaining three sections of chapter 4 provide case studies of three ‘non-finite’ forms in Malayalam: the *uka* ‘citation infinitive/verbal participle’ which this thesis will claim is a progressive participle, the Conjunctive/Adverbial Participle, which will be argued to be a Stump (1985)-style absolute adjunct, and the *athu* ‘gerund’, which the thesis will claim is a type of nominalization that occurs above TP (cf. Borsley and Kornfilt (2000), Baker 2011).

The negation, Conjunctive Participle and *athu* nominalization data presented here will strengthen the arguments from chapter 3 against the tenseless account put forth by Amritavalli & Jayaseelan (2005, et. seq.). While flawed, Amritavalli & Jayaseelan’s (2005) account raises many important questions. Central to their proposal is

the notion of ‘finiteness’. This notion is generally poorly understood, but generally one could say, however ‘finiteness’ is defined, that languages have a variety of both ‘finite’ and ‘non-finite’ forms. The data provided in this paper highlights a number of differences between the three ‘non-finite’ forms in Malayalam. The Conjunctive Participle will play a further role in chapter 5 as it is a crucial component of several of the perfect forms.

Chapter 5 will synthesize all of the parts discussed in the previous chapters and further introduce/explore those in (1-h)-(1-j). The main claim of this chapter is that Malayalam, like Modern Greek (Iatridou et. al. 2003), does not use an active Perf head to express perfect semantics in Universal perfects. Instead, Malayalam uses a combination of the Conjunctive participle, a special a lexical aspect modifier, (1-i), along with tense and either the progressive or ‘imperfective’ viewpoint aspect marker to form the verb used in the Universal perfect. Simple progressive or ‘imperfective’ verb forms without *kondu* can also be used in the perfect in Malayalam. It will also show that, in addition to serving as a viewpoint aspect auxiliary in forms with *kondu*, *irikk-*, (1-j-i), also functions as a light verb which express ‘surprise/unexpectedness’ and as a type of ‘do’ support. The Existential perfect form, which is composed by the Conjunctive participle, the morpheme in (1-j), and the existential copula, (1-f), will also be briefly discussed.

Despite the differences between the Malayalam perfect and the perfect in languages like English, this thesis argues that Malayalam provides further support for the predictions made by Iatridou et al. (2003) and Pancheva (2003, 2013) that the types of lexical and viewpoint aspects a language has will influence the readings of the perfects that it can have. Pancheva (2013) argues, based on data from Greek, Bulgarian, and the Austronesian languages Saisiyat and Niuean, that this prediction is, in fact, borne out. The Malayalam further expands the typology and provides support for this prediction.

Chapter 2

A Tense, Aspect and Perfect

Primer

This chapter is split into two parts: The first half of the chapter surveys the syntactic, morphological and semantic components of tense, aspect and the perfect. This brief, but somewhat in-depth overview is necessary background for the discussion of ‘tenselessness’ in the second half of chapter two, the investigation of the Malayalam tense and aspect in chapter three and the exploration of the Malayalam perfect in chapter five.

The focus of the second half of this chapter, the question ‘what does it mean for a language to be tenseless?’, is an important question to ask in light of Amritavalli and Jayaseelan’s claim that Malayalam is a tenseless language. In the literature, there are basically two different things that can be meant by the term ‘tenseless.’ One major conclusion of the dissertation will be that Malayalam is not a tenseless language (contra Amritavalli & Jayaseelan 2005, Amritavalli 2014 and Jayaseelan 2014). Chapter 3 of the thesis shows that Malayalam is empirically different from other tenseless languages. It, instead, argues for a tensed account along the lines of what Bjorkman (2011, under review) argues for English. In order to argue that Malayalam is not a tenseless language, it is important to know what such a language would look like.

2.1 Basic assumptions about tense, aspect and the perfect

Like all phenomena in natural language, ‘tense,’ ‘aspect’ and ‘the perfect’ have syntactic, morphological and semantic components. This thesis explores all three components of tense, aspect, and the perfect in Malayalam. Before doing that, it spells out and gives a bit of background on the basic theoretical framework assumed in the thesis. The majority of this section focuses on spelling out the semantics. However, it begins with some notes on the syntax and morphology.

2.1.1 Syntactic and morphological component

Turning first to the syntax, the first question to ask is where in the syntactic tree the relevant morphology goes. In the Government and Binding (GB) era, tense, aspect and perfect morphology were located at Infl. Besides simply being the location for this morphology, Infl was also involved in licensing nominative case, hosted an Extended Projection Principle (EPP) feature and was the locus of finiteness. More recently, IP has been replaced with an expanded series of functional projections. In this set of expanded projections, the location of tense morphology has often been assumed to be T. Generally, properties like nominative case assignment and hosting an EPP feature attributed to Infl in GB have been ascribed to T in Minimalism. The syntactic locus of finiteness is more controversial and will be discussed in section 2. Aspect morphology is generally assumed to be at Asp. Iatridou et. al. (2003), Pancheva (2003), Pancheva and von Stechow (2004), and Bjorkman (2011), a.o. have argued that the perfect should also license its own projection, PerfP, the head of which is the location of perfect morphology. This thesis follows these works in assuming that the perfect licenses such a projection and that this projection is located between TP and AspP in the clausal spine. These projections comprise the syntactic component of tense, aspect and the perfect.

The next thing to think about is the morphological nature of tense, aspect and

the perfect. Of course, the syntactic definition and the morphological definition are simply describing different parts of a single entity. In order to link them, it will be argued that the morphological component has two parts. The first and most obvious of these parts is the phonological realization of the morphology. An example of this is the *-ed* that marks the past tense in a verb like *walk-ed*. The second part is an abstract, formal morphological feature. This abstract feature is needed because it is not the case that there is always a single morpheme to express a given meaning. The English past tense provides one example. While the *-ed* suffix is added to regular verbs to mark the past tense, there are irregular verbs that use stem changes to mark the past tense, (cf. *eat* + PAST → *ate* (**eat-ed*)), or do not change their forms at all (cf. *put* + PAST → *put* (**put-ed*)). Thus, it seems reasonable to say that there is a formal feature [PAST], which can be pronounced in different ways. These abstract formal features are present in the syntax. Tense features like [PAST] and [PRESENT] ([PRES]) and perhaps [FUTURE] ([FUT]) will be present on the T head. Aspect features like [PROGRESSIVE] ([PROG]) and [PERFECTIVE] ([PERFV]) will be present in the Asp head. The [PERFECT] ([PERF]) feature will be present on the Perf head. The phonological component will use the features to produce the proper phonological realizations, table 2.1.

Past	Present	Future
<i>live</i> + PAST → <i>lived</i>	<i>live</i> + PRES → <i>lives</i>	<i>live</i> + FUT → <i>will live</i>
<i>put</i> + PAST → <i>put</i>	<i>put</i> + PRES → <i>put</i>	<i>put</i> + FUT → <i>will put</i>

Table 2.1: Tense features and their phonological outputs in English

The interpretive component of the grammar will use these features to assign the sentence a temporal meaning, (1).

- (1)
 - a. PAST → past interpretation
 - b. PRES → present interpretation
 - c. FUT → future interpretation
 - d. PERFV → perfective interpretation
 - e. PROG → progressive interpretation

f. PERF \rightarrow perfect interpretation

This is the basic picture. One focus of this dissertation will be to see how these morphological features ‘drive’ the syntax via their participation in Agreement relationships. So far, the proposed grammar introduces inflectional features, such as [PAST], [PERF], [PERFV], etc in functional projections that are separate from that of the verb. The obvious question then becomes, how do the verb and inflectional material unite? One answer that has been given is that this happens via local movement (Pollock 1989 et seq.; Travis (1984); Bobaljik (1995); Embick and Noyer (2001)). In more recent Minimalist approaches, this question has been handled using the operation Agree. The idea here is that instead of requiring movement, features can simply be valued in situ if the relationship between the two heads is local. If the required locality exists, then a dependency can be established between the two heads, i.e. an Agreement relationship can be established.

This type of proposal is advantageous in that it can explain multiple occurrences of the same inflectional features on multiple verbs. This is found in constructions such as Serial and ‘quasi-Serial’ Verb Constructions (Aikhenvald and Dixon (2006), Zwicky (1969), Pullum (1990), Cardinaletti (2001)), and ‘parasitic participles’ (Den Dikken and Hoekstra (1997), Wurmbrand (2003), a.o.). Under an Agree analysis this data can be straightforwardly accounted for by saying that multiple verbs have an Agree relationship with a single inflectional head. This type of data is difficult for a movement-based theory to account for. In fact, in Minimalism, it is often assumed, following Chomsky (2000), that Agreement between the probe and goal is a necessary precursor of movement. As such, an Agree based theory has greater empirical coverage than a strictly movement based one.

Exactly how one formulates Agree is some matter of controversy. Chomsky (1998) argues that Agree is ‘Downward’. On this account an unvalued feature (called ‘the Probe’) on a given head search (probe) for a c-commanding valued feature (called ‘the Goal’) on another head. The Probe will then enter into an Agree relationship with the Goal and thereby gain valued features. On this formulation, feature

valuation by Agree is ‘Downwards’. On the other hand, it has been argued that unvalued features (‘Probes’) are valued via a ‘Reverse/Upwards’ Agree relationship. Here the Upwards directionality comes because the higher, valued feature (‘the Goal’) probes for the closest unvalued feature (‘the Probe’) (see Adger (2003); Baker (2008); Zeijlstra (2008), Zeijlstra (2010); Haegeman and Lohndal (2010); Merchant (2011); Wurmbrand (2011); Bjorkman 2011, under review, a.o.). This thesis does not take a position regarding what formulation is correct.

The tree in (2) provides an illustration for the system developed so far. There will be an Agreement relationship between the v head and Asp head, the Asp head and Perf head and the Perf head and T head. Further details of this system will be covered in more depth in chapter three where it will be used to explain the distribution of auxiliaries in Malayalam.

(2) Syntax & morphology of tense, aspect and the perfect

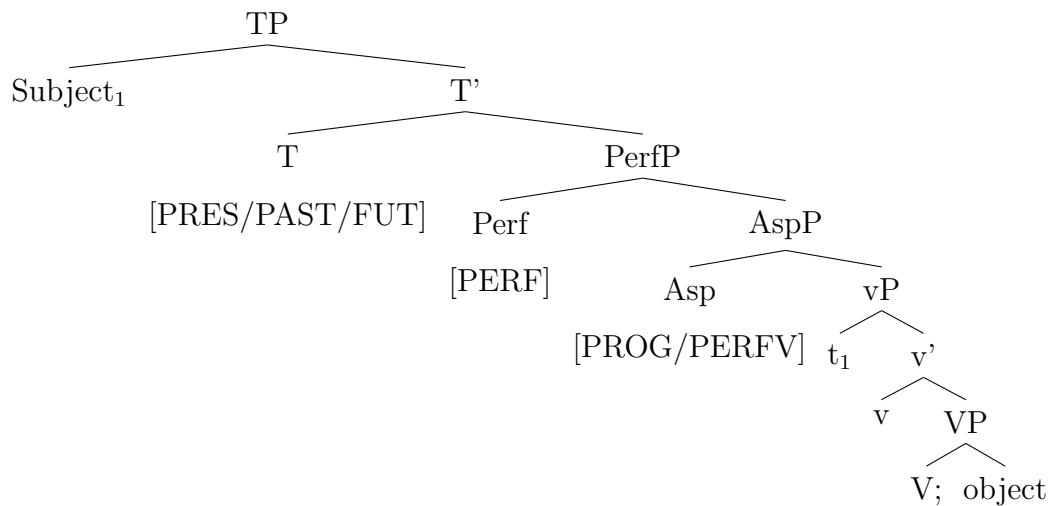

In sum, so far two components of tense, aspect and the perfect have been described: the syntactic component of tense, aspect and the perfect (TP, AspP, and PerfP) and the morphological component, which has two parts: i) the abstract morphological [TENSE/ASPECT/PERFECT] features and ii) their phonological realizations. The tree in (2) has shown the way in which these two components interact.

2.1.2 Semantic component

The final thing that it is necessary to think about is the semantics of tense, aspect and the perfect. In the grammar developed here, this specifically means the component that deals with the way the formal, abstract morphological features are interpreted. The remainder of this section gives basic background on tense, aspect and the perfect based on works such as Klein (1994), Kratzer (1998), Beck and von Stechow (2015), Iatridou et. al. (2003), and Pancheva (2003). Readers who are familiar with these accounts can skip ahead to the next section.

Basic semantics of tense and aspect

This section begins with basic assumptions based on Klein's (1994) reformalization of a Reichenbach (1947)-style account, where someone with no background in tense and aspect semantics might begin, and builds towards a slightly more sophisticated account (either that of Kratzer (1998) or Beck & von Stechow (2015)¹). Since this is only a very short section of the dissertation, it obviously will not do justice to the full picture, but the hope is that this section will allow the reader without background to follow the rest of the discussion in the dissertation.

The exploration of the semantics of tense, aspect and the perfect begins by defining some key terms, starting with the Utterance Time (UT), which is the smallest time interval in which a sentence is uttered (said). It is tempting to think of the UT as 'now' and in many instances this is correct. However, caution is needed in that the notion of 'now' can be stretched beyond just the smallest time interval in which the sentence is said to a larger interval including that time, roughly corresponding to something like 'in the present era.' This use of 'now' is shown in (3-a), where 'now' refers to a span of over 200 years. 'Now' can also be used to give a recent past meaning, (3-b), or an imminent future/futurate (Copley (2008), Copley (2009)), (3-c).

¹This thesis does not take a position on the quantificational versus pronominal status of tense. Either approach would suffice for the purposes of this thesis.

- (3) a. The US has its own government now.
 b. He came just now.
 c. Im going home now.

The second term that will be used to talk about time is the Situation Time (ST), which is the time interval in the actual world throughout which the predicate (roughly the event) holds. Like all intervals, the ST has a Left Boundary (LB) and a Right Boundary (RB), indicated in (4-b) and the other timelines with '[' and ']' respectively. For the UT, this does not really come up, as it is all right to think of UT as a point in time.

- (4) a. What happened yesterday: Mary fell asleep at 5pm and woke up at 7pm.

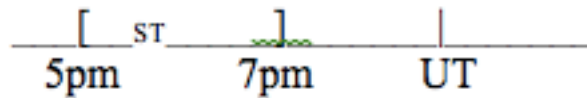

b.

The English past tense will be used as an illustration to help the reader better answer the question of what tense is. Looking at the sentence in (5-a) and its graphic representation (read left to right) in (5-b) the first and seemingly most intuitive hypothesis (H1) is that PAST encodes the temporal relationship that the entire $ST < UT$. This seems to work for (5).

- (5) a. Mary left.

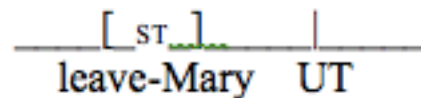

b.

However, under closer scrutiny, it becomes obvious that H1 cannot properly account for the semantics of tense. For (6-b), H1 predicts at UT that 'Mary' is not asleep anymore (the entire $ST < UT$). This seems correction in that (6-b) can be followed by (6-c), yielding the timeline in (6-d).

- (6) a. I walked into the room and saw Mary lying on the floor.
 b. She was sleeping.
 c. So, I shook her, and she woke up.

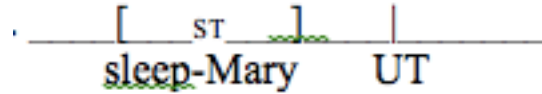

d.

However, the sentence in (6-b) could be followed by the sentence in (7-a), which would have the timeline in (7-b). In this case, the ST starts before the UT but can continue into and even beyond the UT. Thus H1 cannot be correct.

- (7) a. In fact, she was sleeping so soundly that it was impossible to wake her up. She is still lying there asleep. (And, since I know she hasn't slept in 3 days, I'm sure she will still be lying there asleep tomorrow morning.)

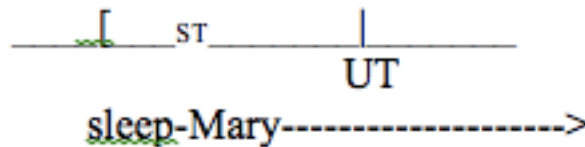

b.

An even more striking example that illustrates the same concept is found in (8). For (8-b), H1 predicts at UT that 'Mary' is not dead anymore (the entire $ST < UT$), as shown in (8-c). The obvious problem with this is that world knowledge tells us that that the state of 'Mary being dead' still holds at UT (and will hold forever beyond that). As a result, the proper timeline is the one in (8-d).

- (8) a. I walked into the room and saw Mary lying on the floor.
 b. She was dead.

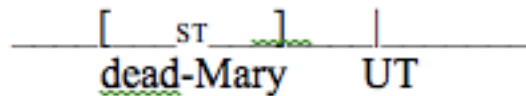

c.

- b. $UT < TT$ (Future tense)
- c. $UT \subseteq TT$ (Present tense)

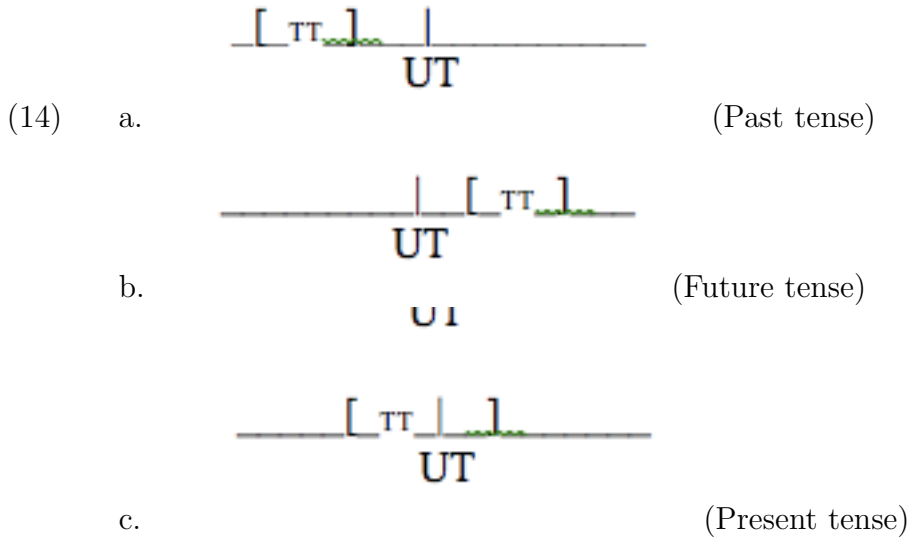

Recall that each of these semantic relationships would be expressed by a matching formal, abstract morphological feature present at T0: PAST, FUT, and PRES, respectively.²

The definition of tense in (13) refers to only two of the three intervals that have been discussed here, the Utterance Time and the Topic Time. Languages also encode the relationship of the ST and TT, and this relationship is called ‘(viewpoint) aspect.’ Examples of the different aspects are given in (15) and their timelines in (16).

- (15) a. $ST \subseteq TT$ (Perfective aspect)
- b. $TT \subseteq ST$ (Progressive aspect)

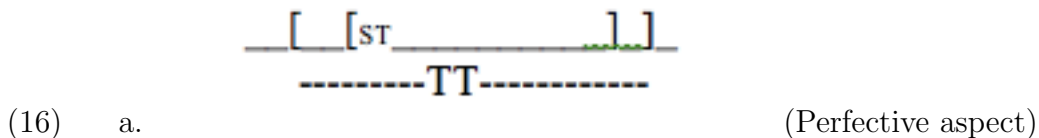

²Things are a bit more complex when it comes to the future. The future is frequently argued to include a modal auxiliary, WOLL, in English and in other languages (cf. Copley 2002, 2009; Matthewson 2006 for St’at’imcets (Salish), a.o.). This WOLL in combination with present tense is pronounced as *will* while with past tense it is pronounced as *would*. This thesis abstracts away from these issues.

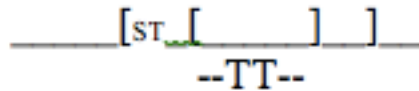

b. (Progressive aspect)

The sentence in (17) and (18) are helpful for understanding the concept of aspect. The TTs here have been bolded while the STs have been italicized. In the perfective sentence in (17) the entire event of reading *Anna Karenina* is contained inside the TT ‘last week.’ This sentence would be an acceptable thing to say when the book was read in its entirety in the week prior to the week containing the UT. The progressive sentence in (18) simply means that at the time that the speaker walked into the room, there was an event of ‘John reading *Anna Karenina*’ going on. The aspect does not specify if ‘John’ is still reading *Anna Karenina* in (18) at the UT (that is the job of tense). It only specifies that the TT is contained inside of John’s reading event.

Perfective aspect

(17) a. **Last week**, *John read Anna Karenina.*

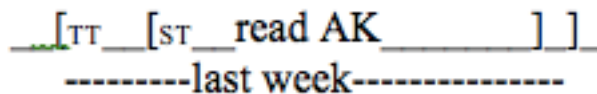

b.

Progressive aspect

(18) a. **When I walked in**, *John was reading Anna Karenina.*

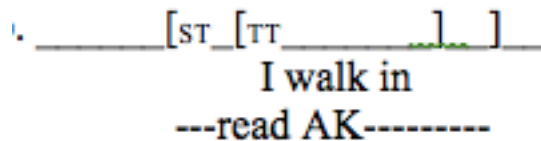

b.

Recall from the earlier discussion that these aspectual relationships will each be expressed by a corresponding abstract, formal morphological feature present at Asp: PERFV³ and PROG, respectively. In order to talk about the phonological realiza-

³Chapter 3 assumes, following the arguments in Bjorkman (2011, under review) that English, in

tion of these viewpoint aspect features, a brief but important segue into lexical aspect (also called aktionsart) is needed.

Lexical aspect is a property of individual predicates. The lexical aspect gives further information about the type of event occurring. This ‘information’ is hierarchically organized. Predicates are broadly separated into statives and eventives (cf. Vendler (1957)). Stative predicates are non-dynamic, non-agentive predicates such as *love*, *know*, *be tall*, etc. Dynamic and/or agentive predicates, such as *throw*, *win*, *build a house*, *eat*, *develop*, *talk*, etc. are called ‘eventives.’ These predicate classes are further divided into telic and atelic predicates. Telic predicates are those which have a telos/culmination and atelic ones are those that do not. Both telic and atelic predicates can be further divided into those predicates which are punctual and those which are durative. A graphic representation of these relationships is given in (19).

(19)

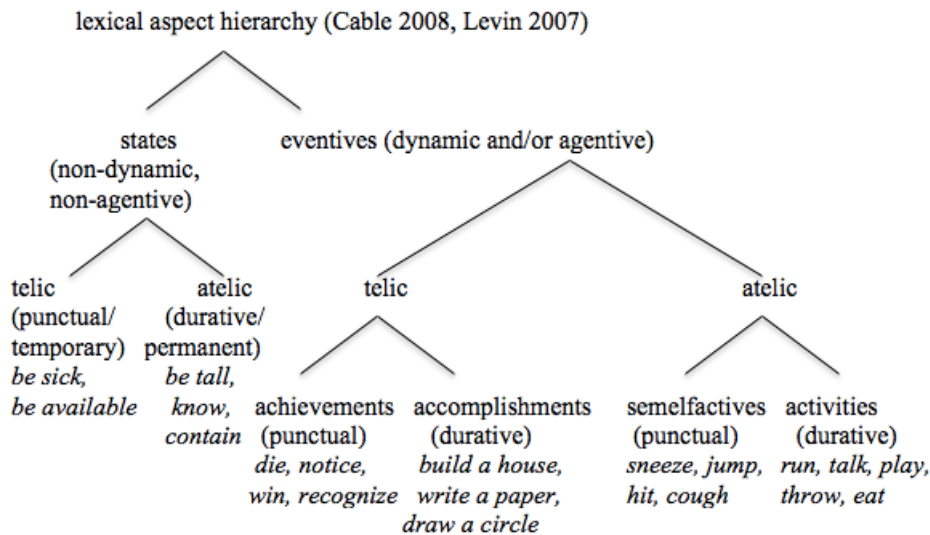

The phonological realization of the progressive aspect feature will be expressed on non-statives using *be* + Verb-*ing*. Some examples include *be throwing*, *be building*, *be eating*, *be developing*, *be talking*, etc. Perfective aspect is simply spelled out using simple past forms such as *threw*, *built*, *ate*, *developed*, *talked*, etc. It is more difficult

fact, lacks a [PERFV] aspect feature. For now, though this is not relevant. The point of this section is to sketch a basic overview of what a simplified grammar for tense and aspect might look like.

to tell if non-dynamic, non-agentive verbs are in the progressive or perfective aspect in English as stative verbs cannot be marked with *be +Verb-ing* in English (cf. **I am loving my mother*). Instead the simple tense forms, i.e. *I love my mother*, must be used.

In sum, lexical aspect is a property of individual predicates which gives further information about the type of event being described by the vP. On the other hand, tense and (viewpoint) aspect are properties of a clause. Tense encodes the relationship between the UT and the TT while (viewpoint) aspect encodes the relationship between the TT and ST. They together work to convey the temporal interpretation of a sentence. Example (20) provides a clear illustration of these facts. Example (20-b) asserts that the $TT < UT$ (past) and the $TT \subseteq ST$ (progressive). In other words, my walking into the room (TT) happens while ‘Mary’ is sleeping (ST) and my walking into the room (TT) preceded the UT.

- (20) a. I walked into the room and saw Mary lying on the floor.
 b. She was sleeping.

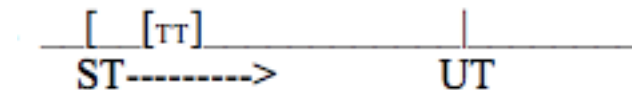

c.

Remember from the discussion of ‘dead’ versus ‘asleep’ that the relationship between ST and UT is not specified by the tense. Due to the lack of world knowledge mitigating otherwise (as in the case of ‘dead’), (20-b) is compatible with the meaning expressed by either (21-a) or (21-b):



- (21) a.

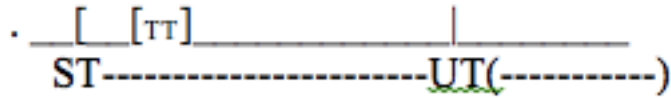

b.

In other words, the sleeping event could have completed before the UT (21-a) or be continuing at the UT (or beyond it), (21-b). Morphologically, the combination of tense and aspect in English is represented in (22).

- (22)
- a. He is eating chicken. (Present progressive)
 - b. He was eating chicken. (Past progressive)
 - c. He will be eating chicken. (Future progressive)
 - d. He ate chicken. (Past perfective)
 - e. He will eat chicken. (Future perfective)

Notice that the combination of present perfective is missing. This form would look like *He eats chicken*. However, the interpretation of this form has a different meaning from what we would expect of a present perfective. The present perfective would assert that the UT contains the TT (say ‘at this very instant’) and that the ST (‘eat chicken’) is contained inside the TT (at this very instant). However, this is not what the sentence *He eats chicken* means. Rather, this sentence suggests that generally he eats chicken (i.e. he’s not a vegetarian, though maybe he does not eat red meat). Cross-linguistically, present perfectives are rare, possibly because it is difficult to get a completed event occurring inside the UT.

This basic review ends with a bit more practice regarding the way that tense and aspect combine. By looking at the sentences below one can see that a future perfective, (23), and a past perfective, (24), only differ in that the UT precedes the TT in the future while the reverse is true in the past. Both sentences have perfective semantics and, as a result, the ST (‘reading of AK’) is contained inside the TT. The difference between the past perfective, (24), and the past progressive, (25), is that the

ST ('AK reading') in the progressive contains the TT ('last week') while the reverse is true in the perfective ($ST \subseteq TT$). Both sentences are past tense and thus the TT ('last week') precedes the UT.

future: $UT < TT$, perfective: $ST \subseteq TT$

- (23) a. Next week I **will read** Anna Karenina



past: $TT < UT$, perfective: $ST \subseteq TT$

- (24) a. Last week I **read** Anna Karenina

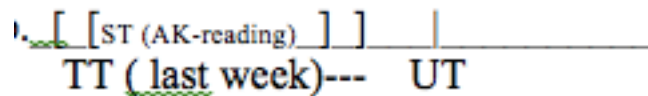

past: $TT < UT$, progressive: $TT \subseteq ST$

- (25) a. Last week I **was reading** Anna Karenina

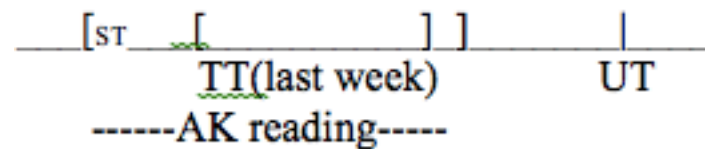

This is the simplest version of tense semantics, which will more or less do for the purpose of this thesis. Much more has been said about tense and aspect.⁴ Only two parts of this larger body of work will be relevant here. First, in order to understand the basic ideas in the overview of the tenseless literature in the second part of this chapter, a debate about the nature of tense (referential versus quantificational) will

⁴For example, see work by Sauerland (2002), Thomas (2014), Abusch (1991), von Stechow (2002), Altshuler and Schwarzschild (2013), Altshuler and Schwarzschild (2012), among many others, for further puzzles and complications.

be introduced. Second, an overview of what is called the imperfective paradox is given. This will help serve as a backdrop for teasing apart certain facts about the different ‘imperfective’ markers in Malayalam in the second half of chapter 3.

The first complication revolves around the nature of tense. There is disagreement about whether tense should be treated like a pronoun (Partee (1973), Kratzer 1998, a.o.), i.e. referentially, or if it should instead be understood as a type of existential quantification (Prior (1967), Ogihara (1989), Kusumoto (1999), Beck & von Stechow 2015, a.o.). Examples of past tense entries from both camps can be found in (26). The entry in (26-a) is a referential one. Here the relationship of UT to TT, i.e. tense, is encoded via a presupposition. Here the superscript g represents the variable assignment function and the superscript c represents the context.

- (26) a. $[[\text{past}]]^{g,c} = [[\text{past}]]^{g,c}$ is only defined if c provides an interval t that precedes t_0 (UT). If defined, then $[[\text{past}]]^{g,c} = t$. (Kratzer 1998 p10)
- b. $[[\text{past}]] = \lambda C_{\langle i,t \rangle} . \lambda t_i . \lambda I_{\langle i,t \rangle} . \exists t' [t' < t \ \& \ C(t') \ \& \ I(t')]$ (Beck & von Stechow 2015 p6: 8)

In the quantificational entry in (26-b), the past tense is a function of type $\langle \langle i,t \rangle, \langle i, \langle \langle i,t \rangle, t \rangle \rangle \rangle^5$ which first takes a contextual restrictor of type $\langle i, t \rangle$, followed by a time argument, t . It then takes a predicate of times, I , and returns a truth-value. Concretely, the t variable represents the UT in the entry in (26-b). The predicate of times represented by I will be the meaning of the AspP. The TT variable, t' , is introduced via existential quantification and contextually restricted by a contextual restrictor, C .

The tree in (27-h) gives an example of a referential style account using entries from Kratzer (1998). It shows the interpretation of a past perfective sentence, here ‘I ate a banana’. The relevant entry for the perfective aspect is given in (27-a) and the computation is given in (27-b)-(27-f).⁶ Kratzer uses type l for events, s for worlds, i

⁵Note that Beck & von Stechow (2015) use i as the type for times and t as the type for truth-values.

⁶For more on the general compositional framework background assumed see Kratzer and Heim (1998) and Fintel and Heim (2011).

for times and t for truth-values. The Asp and T nodes in the syntax contain [PERFV] and [PAST] features, respectively. The presence of these morphological features in the syntax tell the interpretative component of the grammar to use the lexical entries in (27-a) and (26-a).

- (27) a. $[[\text{PERFV}]]^{g,c} = \lambda P_{\langle l, \langle s, t \rangle \rangle}. \lambda t_i. \lambda w_s. \exists e[\tau(e) \subseteq t \ \& \ P(e)(w)=1]$
 (Kratzer 1998, p17)
- b. $[[\text{vP}]]^{g,c} = [[\text{I eat a banana}]]^{g,c} = \lambda e'_l. \lambda w'_s. \text{I eat a banana}(e')(w')$
- c. $[[\text{Asp}]]^{g,c} = [[\text{PERFV}]]^{g,c} ([[\text{vP}]])^{g,c}$
- d. $= [\lambda P_{\langle l, \langle s, t \rangle \rangle}. \lambda t_i. \lambda w_s. \exists e[\tau(e) \subseteq t \ \& \ P(e)(w)]] (\lambda e'_l. \lambda w'_s. \text{I eat a banana}(e')(w'))$
- e. $= \lambda t_i. \lambda w_s. \exists e[\tau(e) \subseteq t \ \& \ \text{I eat a banana}(e)(w)]$
- f. $[[\text{TP}]]^{g,c} = \lambda w_s. \exists e[\tau(e) \subseteq g(i) \ \& \ \text{I eat a banana}(e)(w)]$ (where $g(i) < t_c$ (the UT))
- g. There is an event e of the speaker eating a banana, whose running time τ is included in the contextually salient past time $g(i)$.
- h.

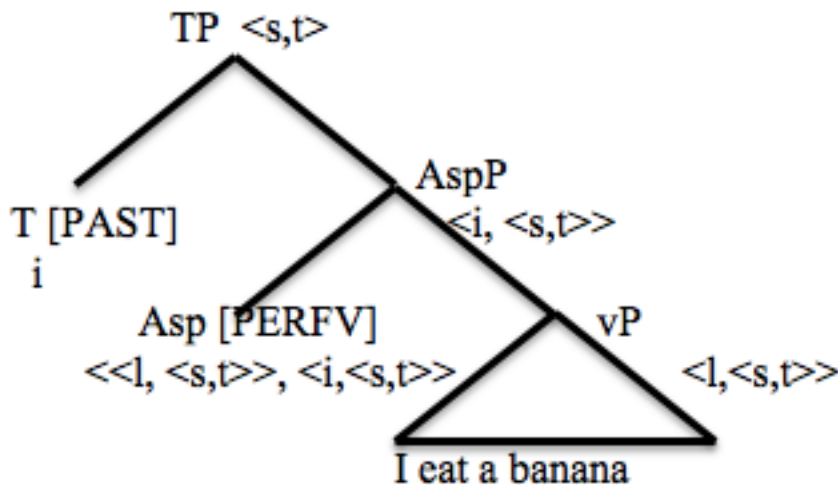

The tree in (28-j) provides an example of a quantificational account for a past perfective sentence using the entries in Beck & von Stechow (2015). The entries for the past tense and perfective aspect are given in (28-a)-(28-b) and the calculation

is in (28-c)-(28-i). Here t' represents the TT and t represents the UT. Beck & von Stechow (2015) use type i for times, v for events, s for worlds, and t for truth-values. The [PERFV] and [PAST] morphological features in the syntax tell the interpretative component to use the semantic entries in (28-b) and (28-a) for the computation.

- (28) a. $[[\text{PAST}]] = \lambda C_{\langle i,t \rangle} . \lambda t_i . \lambda I_{\langle i,t \rangle} . \exists t' [t' < t \ \& \ C(t') \ \& \ I(t')]$ (Beck & von Stechow 2015 p6:8)
- b. $[[\text{PERFV}]] = \lambda t_i . \lambda P_{\langle v,t \rangle} . \exists e [\tau(e) \subseteq t \ \& \ P(e)]$ (Beck & von Stechow 2015 p5:7)
- c. $[[\text{vP}]] = [[\text{I eat a banana}]] = \lambda e'_v . \text{I eat a banana } (e')^7$
- d. $[[\text{AspP}]] = [[\text{Asp}]]([[\text{vP}]])$
- e. $= [\lambda P_{\langle v,t \rangle} . \exists e [\tau(e) \subseteq t' \ \& \ P(e)]] (\lambda e'_v . \text{I eat a banana } (e'))$
- f. $= \exists e [\tau(e) \subseteq t' \ \& \ \text{I eat a banana}(e)]$
- g. $[[\text{TP}]] = \exists t' [t' < t \ \& \ C(t') \ \& \ [\exists e [\tau(e) \subseteq t' \ \& \ \text{I eat a banana}(e)]]$
- h. $= \lambda t . \exists t' [t' < t \ \& \ C(t') \ \& \ [\exists e [\tau(e) \subseteq t' \ \& \ \text{I eat a banana}(e)]]$
- i. There is a relevant time t' before t such that there is an event e of the speaker eating a banana whose running time τ is included in t' .
- j.

⁷Beck & von Stechow (2015), unlike Kratzer (1998), do not assume a modal component in the vP for perfective sentences. While due to the imperfective paradox, the modal component is necessary in the progressive, in simple imperfective sentences it is not 'essential' just to get the tense/aspect meanings that this thesis is focusing on.

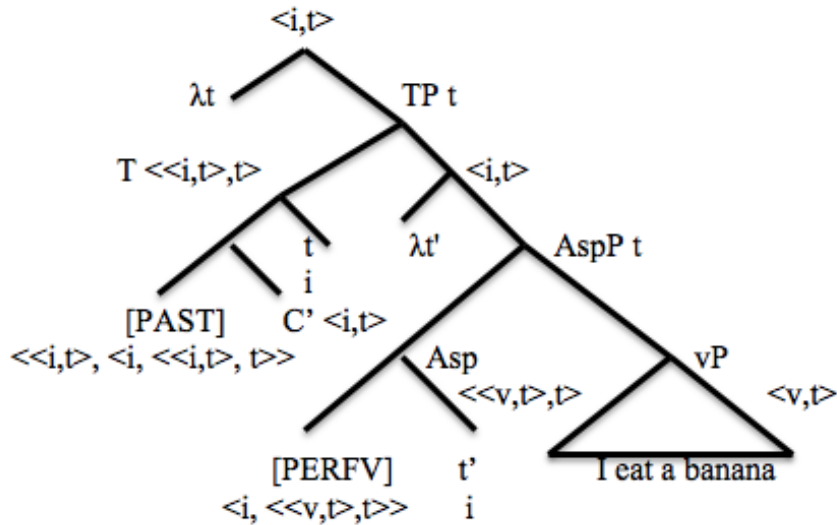

These compositions should give the reader an idea of how the referential and quantificational accounts respectively handle the tense and aspect system proposed so far. They also illustrate the way that the syntax and morphological features work together with the interpretative component to yield a compositional semantic analysis. Whether one assumes a quantificational theory or a referential theory of tense, the role of tense is to relate the Utterance Time and the Topic Time. The role of viewpoint aspect is to relate eventualities with times (following Smith (1991), Klein 1994).

The second complication involves progressive aspect. The puzzle here has been called the imperfective paradox.⁸ The empirical part of the puzzle has to do with the different entailments different types of predicates have in the progressive. Specifically, the progressive of an activity predicate like ‘play basketball’ entails that there was an event of playing basketball. However, the progressive of an achievement predicate like ‘draw a circle’ does not entail that an event of drawing a circle occurred (the drawer could have been interrupted and left the circle unfinished).

In order to account for this empirical puzzle, Dowty (1979) proposed the notion

⁸It is called the ‘imperfective paradox’ not the ‘progressive paradox’ because in many languages there is a single morphological form which expresses both the ‘event-in-progress’ reading and the ‘characterizing/generic/habitual’ reading (see Krifka et al. 1995 for an overview of the ‘characterizing/generic/habitual’ reading). English uses the progressive to express ‘event-in-progress’ readings and the form that morphologically looks like it should express the present perfective (‘He eats meat’) to express the ‘characterizing/generic/habitual’ reading.

of ‘inertia worlds’. These are those worlds in which everything goes as expected (i.e. where there is culmination of all predicates). Worlds (including the actual world) where unexpected events happen that prohibit culmination are not allowed into the inertia worlds. For a clause with progressive aspect to be true, this simply means that the TT (represented by t in (29)) must be contained, non finally, in the larger interval t and that the ST (here represented by τ) must be contained inside t' . This formulation allows the ST to contain the TT, as per the Klein (1994) progressive meaning, but for there to be additional time, here represented by t' for the event to culminate in an inertia world.

$$(29) \quad [[\text{PROG}]] = \lambda w. \lambda t. \lambda P_{\langle s, \langle v, t \rangle \rangle}. \forall w' [w \text{ INERT}_t w' \rightarrow \exists t' [t \text{ is a non-final part of } t' \ \& \ \exists e [\tau(e) \subseteq t' \ \& \ P(w')(e)]]] \text{ (Beck \& von Stechow 2015, cf. Dowty, 1979)}$$

The tree in (30-h) provides an example of how a progressive computation for a past tense sentence like ‘I was eating a banana’ would proceed using a quantificational account for tense. The entry for the past tense in (30-a) is repeated from above. Beck & von Stechow account for the intensional nature of the progressive by assuming a ModalPhrase just above the vP. The computation is given in (30-c)-(30-g).

$$(30) \quad \begin{aligned} \text{a.} \quad & [[\text{PAST}]] = \lambda C_{\langle i, t \rangle}. \lambda t_i. \lambda I_{\langle i, t \rangle}. \exists t' [t' < t \ \& \ C(t') \ \& \ I(t')] \\ \text{b.} \quad & [[\text{vP}]] = [[\text{I eat a banana}]] = \lambda e'_{v.} \text{ I eat a banana } (e') \\ \text{c.} \quad & [[\text{AspP}]] = [[\text{Asp}]](\lambda w'. [[\text{ModIP}]])) \\ \text{d.} \quad & = [\lambda P_{\langle s, \langle v, t \rangle \rangle}. \forall w' [w \text{ INERT}_{t'} w' \rightarrow \exists t' [t' \text{ is a non-final part of } t' \ \& \ \exists e [\tau(e) \subseteq t' \ \& \ P(w')(e)]]]]([\lambda w'. \lambda e'. e' \leq w' \ \& \ \text{I eat a banana}(e')]) \\ \text{e.} \quad & = \forall w' [w \text{ INERT}_{t'} w' \rightarrow \exists t' [t' \text{ is a non-final part of } t' \ \& \ \exists e [\tau(e) \subseteq t' \ \& \ e \leq w' \ \& \ \text{I eat a banana}(e)]] \\ \text{f.} \quad & [[\text{TP}]] = \exists t [t < t''' \ \& \ C(t) \ \& \ \forall w' [w \text{ INERT}_t w' \rightarrow \exists t' [t \text{ is a non-final part of } t' \ \& \ \exists e [\tau(e) \subseteq t' \ \& \ e \leq w' \ \& \ \text{I eat a banana}(e)]]]] \\ \text{g.} \quad & = \lambda w. \lambda t'''. \exists t [t < t''' \ \& \ C(t) \ \& \ \forall w' [w \text{ INERT}_t w' \rightarrow \exists t' [t \text{ is a non-final part of } t' \ \& \ \exists e [\tau(e) \subseteq t' \ \& \ e \leq w' \ \& \ \text{I eat a banana}(e)]]]] \\ \text{h.} \quad & \end{aligned}$$

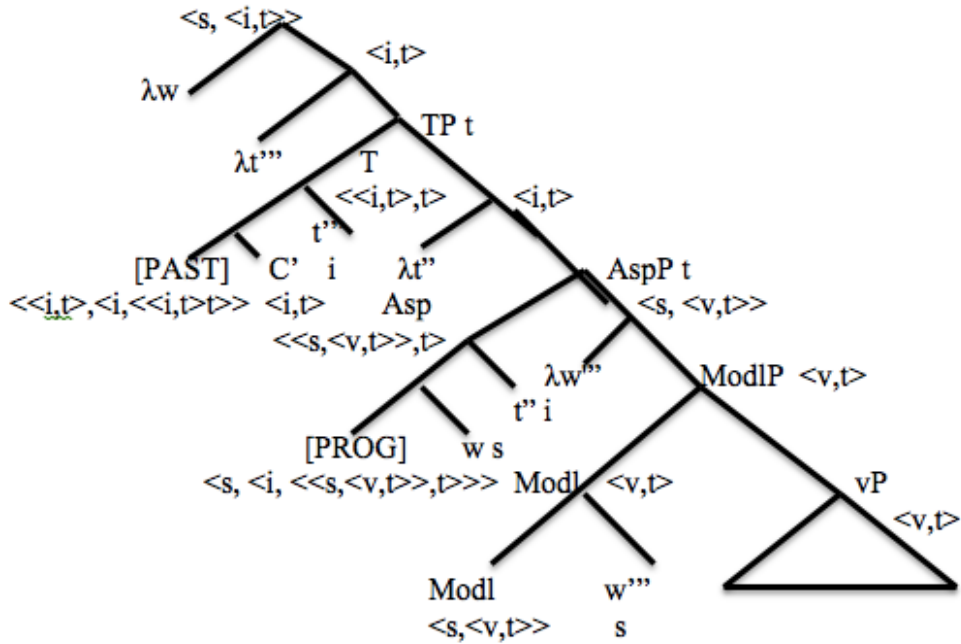

This concludes the background on the semantics of tense and aspect.

Basic semantics of the perfect

This section briefly covers the semantics of the perfect. The sentence in (31) is an example of a perfect sentence. This section will first examine three potential candidates for a semantic account for the perfect, ultimately choosing a Perfect Time Span account (Iatridou et. al. 2003; Pancheva 2003, 2013; Pancheva & von Stechow 2004; and Rothstein (2008); a.o). The second part of the section will discuss the different readings the perfect can have.

(31) I have been sick since 2015.

Reading #1: I have been sick throughout the entire interval between 2015 and the UT (say with cancer)

Reading #2: There is at least one instance of me being sick between 2015 and the UT (maybe I am changing my insurance and have to tell them about my health history)

Given the framework advanced so far, one might ask whether the perfect is a type

of aspect or a type of tense. This is not a trivial question and there has been much debate about the exact nature of the perfect. In Anteriority theory (Reichenbach 1947, Inoue, Klein (1992), Klein 1994, a.o.) the perfect is viewed as syntactically and semantically being a viewpoint aspect. This position, however, predicts that other viewpoint aspects, such as the perfective and progressive, should be in complementary distribution with the perfect. However, this is not the case. In (33)-(35), there are four events, represented by x's, of visiting the Met inside the Perfect Time Span (PTS). The fact that each event represents a completed visit to the Met is the result of the perfective aspect in the sentence. Although commonly confused with the perfect because of the closeness of names in English, the perfective is not equivalent to the perfect. One of the reasons this is so can be seen from the fact that it is possible to have a sentence with a perfect progressive interpretation. In English, the perfect combines with the three tenses (present, future and past) and two aspects (perfective and progressive) in a morphologically visible manner:

- (32)
- a. I have visited the Met (present perfect perfective)
 - b. I will have visited the Met (future perfect perfective)
 - c. I had visited the Met (past perfect perfective)
 - d. I have been visiting the Met (present perfect progressive)
 - e. I will have been visiting the Met (future perfect progressive)
 - f. I had been visiting the Met (past perfect progressive)

The sentences in (32) show that the perfect is not in complementary distribution with viewpoint aspect, as predicted by Anteriority Theory.

Another possibility is that the perfect is a type of lexical aspect (aktionsart). This, in fact, is the position of Result State theory (Parsons (1990), Kamp and Reyle (1993), Giorgi and Pianesei 1998, a.o.). On this theory the perfect is a type of derived aktionsart, specifically a derived result state. This would predict that the perfect, as a type of aktionsart, should appear below viewpoint aspect in the syntax, as the role of aktionsart is to provide more information about what type of event is occurring. The role of viewpoint aspect, on the other hand, is to relate eventualities

with times (Smith 1991, Klein 1994). Given the English, Greek, and Bulgarian data pointed out in Iatridou et. al. 2003 and Pancheva 2003, this ordering would be problematic for the morphology, assuming something like the Mirror Principle (Baker 1985). If viewpoint aspect were located below the perfect on this theory, they would also need to be derived aktionsarten. In other words, viewpoint aspect would no longer link events and times but would simply give further information about the type of event occurring. If the move was made to view viewpoint aspects as derived aktionsarten, it would require a new answer about how events are related to times. A potential solution, proposed by Kamp, Reyle & Rossdeutscher (2013) is for verbs to have temporal features in their lexical entries.

A third option, that requires less extreme modifications of the grammar, is that of the Perfect Time Span (PTS) account for the perfect (Iatridou et. al. 2003; Pancheva 2003, 2013; Pancheva & von Stechow 2004; and Rothstein 2008; a.o.). This is an approach in the spirit of what is known as the Extended Now theory (McCoard (1978), Dowty 1979, a.o.). On this approach, the perfect is like a relative tense, i.e. one that relates two Topic Times to each other, instead of relating a single Topic Time with the Utterance Time.

Like all intervals, the PTS has a left and a right boundary. The left boundary (LB) of this time span is set by an adverbial (*since 1990, for 3 years, always*, etc) or by the context (for example, the speaker's birth). The right boundary (RB) of the time span is set by tense: in the present the right boundary is the utterance time, in the past, the right boundary is before the utterance time, and in the future, the right boundary is after the utterance time. This is exemplified in (33)-(35).

- (33) a. Since Thursday, I have visited the Met four times. (present perfect perfective)



b.

- (34) a. I saw him last Tuesday. At that point, he had visited the Met three times. (past perfect perfective)

- b.

his birth x x x RB |

Tues UT
- (35) a. By Monday, Ann will have visited the Met two times. (future perfect perfective)
- b.

Ann is born x | x RB or

UT Monday
- c.

Ann is born x x | RB or

UT Monday
- d.

Ann is born | x x RB

UT Monday

The reading in (35-c) becomes particularly salient if something like, ‘In fact, for all I know, she may have been to the Met twice already’ is added.

Pancheva (2003) provides the formal PTS account entry for the perfect in (36). The first function of the perfect here is to set up the PTS, a TT interval, represented by the time interval variable t'' in (36). The second function of the perfect is to locate the TT (represented by the time interval variable t' in (36) in a final subinterval of the PTS, in other words, with the right boundary.

- (36) $[[\text{perfect}]] = \lambda p_{\langle i, t \rangle}. \lambda t'_i. \exists t''_i [\text{PTS}(t'', t') \ \& \ p(t'')]$
 PTS (t'' , t') iff t' is a final subinterval of t'' (Pancheva 2003 p284: 9b)

The reader can see the calculation for the present perfect perfective sentence *I have eaten a banana*, in (37). The relevant entries are in (37-a)-(37-c). Here Kratzer’s referential entry for tense is used. Her entry for perfective aspect as been modified to remove the world argument, as the presence of this argument is not crucial for our purposes. The computation is given in (37-d)-(37-h). Just like other functional categories, a morphological [PERF] feature located on Perf tells the interpretative component to use the entry in (37-b).

- (37) a. $[[\text{past}]]^{g,c} = [[\text{past}]]^{g,c}$ is only defined if c provides an interval t that

precedes t_0 (UT). If defined, then $[[\text{past}]]^{g,c} = t$. (Kratzer 1998 p10)

- b. $[[\text{perfect}]]^{g,c} = \lambda p_{\langle i,t \rangle}. \lambda t'_i. \exists t'' [PTS(t'', t') \ \& \ p(t'')]$
 $PTS(t'', t')$ iff t' is a final subinterval of t''
- c. $[[\text{PERFV}]]^{g,c} = \lambda P_{\langle l,t \rangle}. \lambda t_i. \exists e[\tau(e) \subseteq t \ \& \ P(e)=1]$
- d. $[[\text{vP}]]^{g,c} = [[\text{I eat a banana}]] = \lambda e_l. \text{I eat a banana}(e)$
- e. $[[\text{AspP}]]^{g,c} = [[\text{perfective}]]^{g,c} ([[vP]]^{g,c})$
- f. $= \lambda t_i. \exists e[\tau(e) \subseteq t \ \& \ \text{I eat a banana}(e)]$
- g. $[[\text{PerfP}]]^{g,c} = \lambda t'_i. \exists t''_i. t' \text{ is a final subinterval of } t''. [PTS(t'', t') \ \& \ \exists e[\tau(e) \subseteq t'' \ \& \ \text{I eat a banana}(e)]]$
- h. $[[\text{TP}]]^{g,c} = \lambda t'_i: t_c \subseteq t'. \exists t''_i. t' \text{ is a final subinterval of } t''. [PTS(t'', t') \ \& \ \exists e[\tau(e) \subseteq t'' \ \& \ \text{I eat a banana}(e)]]$
- i.

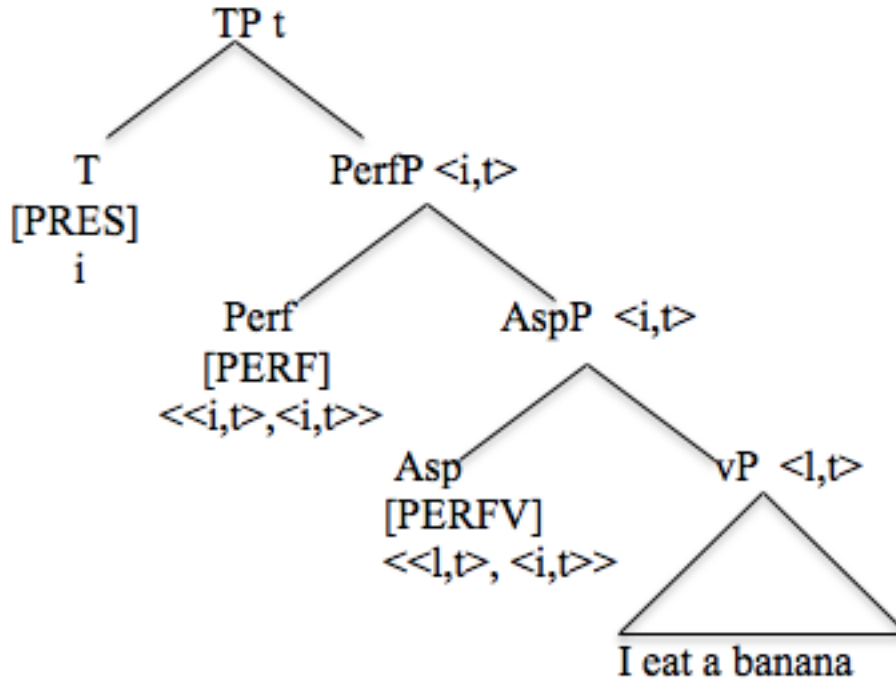

In this system, viewpoint aspect relates eventualities to times and the perfect is like a relative tense in that it introduces an additional TT interval and relates this interval to the main TT. The present tense sets the UT as being contained inside the main TT that is the RB of the PTS. This provides an explanation for the

morphological ordering that does not force us to view viewpoint aspect as a type of derived aktionsart, as in the Result State theory. This approach also does not make a prediction that the perfect should be in complementary distribution with viewpoint aspect, unlike the Anteriority theory. For the remainder of this dissertation, the PTS account will be assumed.

The discussion so far has been centered on the basic semantics of the perfect. The rest of the section will focus on two different types of readings the perfect can have. Examples (33)-(35) are an instance of what is known as the Existential perfect. This simply means that there has been at least one instance of the event in the PTS. In other words, the Existential perfect requires that there be existential quantification over points in the time span. It says nothing, however, about whether or not the event still holds at UT.

A second reading that the perfect can have is called the Universal perfect reading. On this reading, the eventuality holds throughout the PTS (i.e. there is universal quantification over points in the time span. In other words, the predicates have what is known as the ‘subinterval property’: if there is an instantiation of a predicate that occurs at i , it also occurs at every subinterval of i). This universal quantification is provided by a durative adverb such as *for one week (now)*, *(ever/at least) since Monday*, or *always*. The adverbs *for one week* and *since Monday* are eventuality level adverbs and allow but do not force a Universal perfect reading. If the additional words in parenthesis are added to these adverbials, they become perfect-level adverbs and, like *always*, require a Universal perfect reading (Iatridou et. al. 2003).

In order for a form to be compatible with a Universal perfect meaning, it must have an aspectual specification that is compatible with the universal quantification needed for a Universal Perfect. In other words, Universal perfects can only occur with stative or activity predicates (which naturally involve the subinterval property) or progressive marked non-stative predications (which obtain the subinterval property by their viewpoint aspect). Just as with the Existential perfect, the right boundary of the PTS on a Universal perfect reading varies with tense: in the present the right boundary is the utterance time, in the future, the right boundary is after the utterance

time, and in the past, the right boundary is before the utterance time.

A crucial question at this point is, is there a single semantics for the different perfect readings? The answer of the PTS account is that there is. Specifically, the type of perfect expressed will depend on different grammatical factors such as the interpretation and/or scope of adverbs combined with the type of viewpoint aspect present and the aktionsart of the predicate. The role of adverbs in obtaining the different readings can be seen in a sentence like (38) and (39). The interpretation of (38) varies depending on what the adverbial phrase *for three months* modifies (i.e. the adverb scope is the critical factor), while in (39) the way the adverbial phrase *since Monday* is interpreted will determine which reading the sentence gets.

(38) Betsy has been in Boston for three months

- a. Universal: ADV is a PTS modifier (high scope)
- b. Experiential: ADV is an event-time modifier (low scope)

(39) Betsy has been in Boston since Monday.

- a. Universal: durative PTS-modifying ADV
- b. Experiential: inclusive PTS-modifying ADV (Pancheva 2013 slide 14)

The sentences in (40)-(44) highlight the role of viewpoint aspect and aktionsart. With a telic predicate like ‘write a letter,’ the availability of the different readings is highly constrained by the viewpoint aspect: the progressive is needed for a universal reading, (41), and the perfective is needed for an experiential reading, (40). This is due to the fact that telic predicates do not by themselves license the subinterval property. Progressive aspect must do this job. Atelic, activity predicates, on the other hand, can license the subinterval property themselves and are thus compatible with a universal reading even without the progressive. They allow universal and existential readings with both perfective and progressive viewpoint aspects, (42)-(43).

(40) Betsy has written a letter since Monday. (perfv telic)

- a. *universal: perfective durative PTS-ADV

- b. experiential: perfective inclusive PTS-ADV
- (41) Betsy has been writing a letter since Monday. (prog telic)
- a. universal: progressive durative PTS-ADV
 - b. ?⁹experiential: progressive inclusive PTS-ADV (Pancheva 2013 slide 19)
- (42) Ann has watched TV since Monday. (perfv atelic, activity)
- a. universal: perfective durative PTS-ADV
 - b. experiential: perfective inclusive PTS-ADV
- (43) Ann has been watching TV since Monday.(prog atelic, activity)
- a. universal: progressive durational PTS-ADV
 - b. ?experiential: progressive inclusive PTS-ADV
- (44) Have you ever been watching TV when the tube exploded? experiential: progressive viewpoint aspect (Comrie 1976)

Such an account predicts that, cross-linguistically, the types of lexical and viewpoint aspects a language has will influence the readings of the perfects that it has. Pancheva (2013) argues, based on data from Greek, Bulgarian, Saisiyat and Niuean (Austronesian) that this prediction is, in fact, borne out. Chapter 5 of this thesis will show that, despite the seemingly drastic differences between the perfect in English and Malayalam, Malayalam actually provides further evidence in support of this prediction.

This ends the review of the perfect and the larger review of the syntax, morphology and semantics assumed for tense, aspect and the perfect. The next section will focus on tense and explore what it means for a language to be ‘tenseless’.

2.2 What is a tenseless language?

Section 1 surveyed the syntactic, morphological and semantic components of tense, aspect and the perfect. This section will focus mainly on tense and will ask the

⁹Pancheva gives this reading a ? but I would give it a *.

specific question, what does it mean for a language to be tenseless? This is a relevant question because one major conclusion of the dissertation will be that Malayalam is not a tenseless language (contra Amritavalli & Jayaseelan 2005, Amritavalli 2014 and Jayaseelan 2014). Chapter 3 of the thesis shows that Malayalam is empirically different from other tenseless languages. It, instead, argues for a tensed account along the lines of what Bjorkman (2011, under review) argues for English.

There are basically two different things that can be meant by the term ‘tenseless.’ This section presents a brief summary of these two camps. Before getting into the details of any of these accounts though, all parties involved agree that all languages, even tenseless ones, have a way to express temporal semantics (i.e. the semantic component of tense). Instead, tenseless languages are ones in which part or all of (both) the morphological or syntactic components of tense are missing. Exactly what is missing is where the disagreement lies.

2.2.1 ‘No overt morphology’ camp

In what I will call the no overt morphology camp, a tenseless language is one which lacks overt morphology that encodes temporal semantics (Smith et al 2003, 2007 for Navajo; Smith & Erbaugh 2005 and Lin 2003, 2006, 2010 for Mandarin; Mucha 2012, 2013 for Hausa; Bohnemeyer 2009 for Yucatec Maya; Tonhauser 2011 for Paraguayan Guaran; Shaer 2003 and Bittner 2005 for Kalaallisut, Matthewson 2006 for St’at’imcets) as opposed to lacking a TP (which is what the second camp will claim). Those accounts that define tenselessness as languages with no overt morphology can broadly be separated into a tensed account (have covert, i.e. phonologically null, tense features/morphology) or a tenseless account (have no covert or overt tense features/morphology).

2.2.2 Tensed account for tenseless language

Matthewson (2006) is an example of a tensed account. In St’at’imcets root sentences can receive a present or past interpretation but not a future one, (45-a). As such,

she argues that the language has a single [TENSE] feature that is defined as in (46). Notice that Matthewson assumes a pronominal account of tense. Here i represents a time variable.

St'at'imcets

- (45) a. **matq** [kw s-Mary]
 walk DET NOM-Mary
 'Mary walked/Mary is walking' [ok Pres, ok Past, X Fut](Matthewson 2006 p8: 14)
- b. **matq** *kelh* [kw s-Mary]
 walk WOLL DET NOM-Mary
 'Mary will walk.' (Matthewson 2006 p20: 37)

- (46) [[TENSE]] ^{g,c} is only defined if no part of $g(i)$ is after t_c .
 If defined [[TENSE]] ^{g,c} = $g(i)$ (Matthewson 2006 p8: 13)

This feature is spelled out by a covert tense morpheme. It does not necessarily have to be located at T, though it could be. As such a sentence such as (45-a) would have the meaning in (47).

- (47) $\lambda w_s. \exists e[\text{walk}(e)(w) \ \& \ \text{agent}(\text{Mary})(e)(w) \ \& \ \tau(e) \subseteq g(i)]$ (where no part of $g(i)$ follows t_c .) (Matthewson 2006 p8: 15b)

In order to get future interpretations, *kelh* must be added, (45-b). Matthewson argues that *kelh* is not a tense marker, as previously thought but the equivalent of English WOLL. Future temporal semantics are obtained when *kelh* combines with the [TENSE] feature. The calculation for the St'at'imcets future sentence in (45-b) is given in (48-b)-(48-d).

- (48) a. $[[\text{kelh}]]^{g,c} = \lambda P_{\langle i, \langle s, t \rangle \rangle}. \lambda t_i. \lambda w_s. \exists t'[t < t' \ \& \ P(t')(w)=1]$
- b. $[[\text{AspP}]]^{g,c} = \lambda t_i. \lambda w_s. \exists e. [\text{walk}(e)(w) \ \& \ \text{agent}(\text{Mary})(e)(w) \ \& \ \tau(e) \subseteq t]$
- c. $[[\text{kelhP}]]^{g,c} = \lambda t_i. \lambda w_s. \exists t' [t_i \ t' \ \& \ \exists e [\text{walk}(e)(w) \ \& \ \text{agent}(\text{Mary})(e)(w) \ \& \ \tau(e) \subseteq t']]$
- d. $[[\text{TP}]]^{g,c} = \lambda w_s. \exists t' [g(i) < t' \ \& \ \exists e [\text{walk}(e)(w) \ \& \ \text{agent}(\text{Mary})(e)(w) \ \& \ \tau(e)$

$\subseteq t'$] (where no part of $g(i)$ follows t_c) (Matthewson 2006 p20: 36, 38b-d)

2.2.3 Tenseless accounts for tenseless language

A tenseless account of a tenseless language is one in which there is no abstract, formal morphological tense feature (and as a result no covert tense morpheme). Remember that there is universal agreement that tenseless languages still have a way to express temporal semantics. Also recall that in the grammar spelled out so far, the abstract, formal, morphological [TENSE] feature is what has been communicating to the interpretative component that a given string should receive a particular temporal interpretation. Since this feature is absent in tenseless accounts of tenseless languages, something else must play this role.

Tonhauser (2011), Bittner (2005), Bohnemeyer (2009), Smith et. al. (2003, 2007), (Smith & Erbaugh 2005), Mucha (2012, 2013) argue that when a language lacks tense morphology and a [TENSE] features, other mechanisms like pragmatic factors, temporal anaphora and aspectual specification, are used to express the relationship between TT & UT. Temporal anaphora is roughly the idea that tense is pronominal and that tense can relate one TT to another contextually determined TT, instead of relating the TT and UT. This arises for Tonhauser as the result of different semantic rules that tenseless as opposed to tensed languages have. For Bittner, Bohnemeyer and Mucha, temporal anaphora arise as a result of pragmatic reasoning.

Tonhauser (2011) focuses on Paraguayan Guarani. As in St'at'imcets, simple sentences can have a present or past, but not future, interpretation, (49). The use of adverbs also confirms this: a given sentence can be modified by a past or present adverb but not a future one.¹⁰ However, in certain contexts where a previous conjunct is morphologically marked to express the future, a given unmarked verb can receive a future interpretation. This asymmetry is the key point Tonhauser needs to account for. An example of future marking in a previous conjunct is given in ((50)). The future marker in ((50)) is the prospective aspect marker (glossed as PROSP) on the

¹⁰Matthewson (2006) also shows parallel facts in St'at'imcets that present and past, but not future, temporal adverbs are allowed with such sentences.

verb in the ‘since’ clause.¹¹

(8) Paraguayan Guarani

- (49) a-jahu
A1sg-bathe
‘I am/was/#will be bathing.’ [ok Pres, ok Past, X Fut]

Context: It’s morning and the speaker is talking about a goose walking past her and the addressee.

- (50) Ja’u-ta-re ko ganso ko’ero, a-juka ko ka’aru-pe.
A1pl.incl-eat-PROSP-for this goose tomorrow A1sg-kill this afternoon-at
‘Since we are going to eat this goose tomorrow, I will kill it this afternoon.’
(Tonhauser 2011 p260: 5, 4c)

Tonhauser explains this asymmetry by using two separate semantic rules in tenseless and tensed languages. On Kratzer’s (1998) formalization of a pronominal account for tense, the entries for tense include a presupposition that the context provides a TT that precedes the UT (in the case of past tense) or contains the UT (in the case of present tense). For tensed languages, Tonhauser’s rule basically does the same work as Kratzer’s presupposition, though instead of being written into a lexical entry for tense, Tonhauser assumes that the final step of the computation is to apply the rule in (51).

Matrix clause rule (tensed analysis)

- (51) The final translation of a matrix clause translated as ϕ of type $\langle w, \langle i, \langle i, \tau \rangle \rangle \rangle$ is $\phi(w_0, t_{\text{topic time}}, \text{now})$ of type τ . (Tonhauser 2011: 22, p270)

In a tenseless language, the final step of the computation is to apply the rule in (52). The only difference between (51) and (52) is that in (52), another TT interval is used instead of the UT.

Matrix clause rule (tenseless analysis)

¹¹A1=a type of prefix that marks transitive subjects as well as some intransitive subjects.

- (52) The final translation of a matrix clause translated as ϕ of type $\langle w, \langle i, \langle i, \langle i \rangle \rangle \rangle$ is $\exists t(\phi(w_0, t_{\text{topic time}}, t))$ of type τ .

Basically, in more Kratzerian terms, in a tenseless language there is no presupposition that defines TT in relation to the UT. Instead, tense is defined via relating one contextually given TT to another such TT. Since tenseless languages lack formal, tense morphology features, this information is encoded in a semantic rule, not the lexical entry for the tense feature. If the TT of the ‘antecedent’ clause follows the UT, say because the verb in that clause is marked with a prospective aspect which licenses future readings, then the TT of the clause containing the zero-marked verb can also be interpreted as occurring after the UT.¹²

Kalaallisut (West Greenlandic), the focus of Bittner’s (2005) work, like Paraguayan Guarani and St’at’imcets, has no present or past tense morphemes, and unmarked sentences can receive both past and present interpretations, (53), (also see Shaer (2003) who makes the same point).

- (53) aggir-puq
 come.IND-3sg
 ‘He is/was coming.’ (Shaer 2003 p146: 7a)

The basic idea of Bittner’s analysis is similar to Tonhauser’s. In Kalaallisut certain markings on the verb yield certain default interpretations. Since events can only be reported as facts if they have already happened, the presence of a factive mood marker, will yield a past default interpretation. Likewise, in isolation, current states, processes, and habits will obtain a default present reading from the UT, the default TT. Future readings are obtained via one of many prospective mood markings. However, when the context introduces a TT that has a different relationship with the UT

¹²Specifically she uses the mechanism of context update in a dynamic semantics Aloni et al. (2000), to say that a context σ' can be updated with a future TT only if the current context, σ , already supports a future TT. She argues that temporal reference is contextually restricted to non-future times in Paraguayan Guarani because Paraguayan Guarani lacks a future tense (in the sense of $UT < TT$), and instead uses an event time option, $UT = TT < ST$, for future reference. As such, future discourse is expressed using prospective aspect/modal markers, possibility and necessity modals, and prospective moods.

than the default TT, that new TT can be used instead of the UT. This temporal anaphora allows non-default tense interpretations to appear.

Bohnenmeyer, studying Yucatec Mayan, proposes that this language also expresses tense semantics by using temporal anaphora instead of tense features with lexical entries specifying the relationship of the TT with respect to the UT. His model generates temporal anaphora by using the definition in (54) along with the pragmatic principles in (55) and (56).

(54) *Natural temporal reference point* (NTRP): A time interval t is an NTRP in a given discourse iff t is identified in that discourse as either (a) the coding time of some utterance or (b) a calendrical time interval or (c) an event time (the ‘run’ time of an event described in the discourse). (Bohnenmeyer 2009 p34: 31)

(55) *Preferred topic time selection*: The topic times selected in a given discourse context are preferred to be identical to or include NTRPs identified in the same discourse context. (Bohnenmeyer 2009 p36: 33)

(56) *iconicity implicature*: ”The order of clauses iconically reflects the order of events.” (p38)

Root perfective marked sentences without any adverbs will be interpreted as past based on (54c), (55) and (56): perfective aspect introduces its own event time that can serve as the TT, (55), and this event presumably occurs before the event of uttering the sentence ($TT < UT$). Root progressive marked sentences without any adverbs will take the UT as their TT due to (54a) and (55), ($UT \subseteq TT$). Temporal adverbs providing calendrical intervals will provide another potential TT for the sentences, due to (54b).¹³

In Hausa, sentences lack tense morphemes but have aspectual marking. Mucha (2012, 2013) builds off of the system first presented in Smith et al (2003, 2007) for

¹³Bohnenmeyer does not have isolated simple root sentences with adverbs in his paper, so I am not sure exactly what happens when, say, a present tense adverb is added to a root perfective marked sentence.

Navajo¹⁴ and extends and adapts the analysis to Mandarin (Smith & Erbaugh 2005) to account for temporal interpretation in Hausa. The core of the proposal here is that aspectual information is used along with pragmatic principles to provide default interpretations for clauses. However, these defaults can be overridden, as in other languages surveyed in this section, when the context provides another TT that has a different relationship with the UT than that of the default TT.

In this account, viewpoint aspect interacts with the pragmatic principles in (57)-(59) to yield temporal interpretation.

(57) *Deictic Principle*: Situations are located with respect to Speech Time [=UT].
(Smith et. al. 2007: 1, p44)

(58) *Bounded event constraint*: Bounded events are not located in the present.
(Smith et. al. 2007: 2, p45)

(59) *Simplicity Principle of Interpretation*: choose the interpretation that requires the least info added or inferred (Smith et. al. 2003: 18, p186)

Smith et. al. (2003) further propose the pragmatic principle in (61) to account for zero-marked verbs, i.e. verbs that are not overtly marked for viewpoint aspect. Such verbs are common in Navajo and Mandarin, (61). In these zero-marked cases, stative verbs will be interpreted as having progressive viewpoint aspect while eventive verbs will be interpreted as having perfective aspect.

(60) *Temporal Schema Principle*: Interpret zero-marked clauses according to the temporal schema¹⁵ of the situation expressed. (Smith et. al. 2003: 19, p187)

Mandarin

¹⁴According to Smith et. al. Navajo is 'partially tensed' in having tense participles that appear to encode tense semantics but are not obligatory. As such, Navajo may not be a tenseless language in the sense meant in this section.

¹⁵The term 'temporal schema' here refers to whether a predicate is stative or eventive. This basic idea has previously been proposed by Welmers and Welmers (1968) for Igbo and Damoiseau (1982) and Déchaine (1991) for Haitian.

- (61) a. Wo **zhu** zai Lutedan.
 I live in Rotterdam
 ‘I live in Rotterdam.’ [ok Pres, X Past, X Fut]
- b. Zhangsan **dapuo** yi-ge heaping
 Zhangsan break one-Cl vase
 ‘Zhangsan broke a vase.’ [X Pres, ok Past, X Fut] (Lin 2010 p307: 3a-b;
 Lin 2006 p3:3a)

The system then works as follows to obtain the temporal semantics: progressive marked sentences receive default present interpretations as a result of the Deictic Principle and the Simplicity Principle. Since situations are located with respect to the speech time, as stated in the Deictic Principle, and the event is unbounded, the simplest interpretation is that of the present. The same principles plus the Bounded Event Constraint apply to perfective marked sentences to give a default past interpretation: since bounded events cannot occur in the present, a past interpretation is simpler than a future interpretation because it does not require the addition of a modal base. Future interpretations are obtained when the verb is marked with a future mode in Navajo, a modal marker plus prospective aspect marker in Hausa and a modal marker in Mandarin, (as (62-b) below shows).

These principles are viewed as pragmatic principles not semantic ones because they can be overridden by adverbs and context such that verbs have tense interpretations other than their default interpretations. In Mandarin, the addition of a past time adverb like ‘yesterday’ or ‘in 1989’ to a sentence with a progressive viewpoint aspect is enough to override the default present interpretation and to give a past interpretation, (62-a).

Mandarin

- (62) a. Wo *1989 nian* **zhu** zai Lutedan.
 I 1989 year live in Rotterdam
 ‘I lived in Rotterdam in 1989.’ [ok Past] (Lin 2010 p307: 3c)
- b. wo *hui* **zhu** zai Lutedan.
 I will live in Rotterdam
 ‘I will live in Rotterdam.’ [ok FUT]

An adverb alone is not sufficient to override the default in Hausa, (63-b). However, when put in a context that makes an alternate topic time salient, the default is overridden, (64). As a result of this possibility, a given progressive or perfective sentence in the right context can receive a present¹⁶, past, or future interpretation.

- (63) a. Ali yana wasa
 Ali 3SG.M.PROG play
 ‘Ali is playing.’
 b. ??yana wasa jiya.
 3SG.M.PROG play yesterday
 ‘He was playing yesterday.’

Context question: What was Hasan doing when Ali entered his house yesterday?

- (64) Lokacin da Ali ya zo, Hasan yana wasa.
 When Ali 3SG.M.REL.PFV come Hasan 3SG.M.PROG play
 ‘When Ali came, Hasan was playing.’ (Mucha 2012, p195-196: 17, 21)

To account for this, Mucha proposes the principle in (65).

- (65) *Contextual Reference Time Anchoring*: Explicit temporal information may override pragmatic defaults. If the previous discourse context provides a TT alternative to the pragmatic default, this TT serves as a temporal anchor for the time variable of the sentence. (Mucha 2013, p393: 48)

The time variable, say t_6 , referred to here is located at T. All sentences will have this variable, which simply refers to the TT provided by the context, whatever that may be. The calculation for a simple sentence like ‘Hawwa ran’ is provided in (66).

- (66) a. $[[\text{AspP}]]^g = \lambda t_i. \lambda w_s. \exists e [\text{run}(e)(w) \ \& \ \text{agent}(\text{Hawwa})(e)(w) \ \& \ \tau(e) \subseteq t]$
 b. $[[\text{TP}]]^g = \exists = \lambda w_s. \exists e [\text{run}(e)(w) \ \& \ \text{agent}(\text{Hawwa})(e)(w) \ \& \ \tau(e) \subseteq g(6)]$
 (where $g(6)$ is the contextually provided topic time) (Mucha 2013 p395: 52)

¹⁶Mucha notes that it is hard to get a present perfective sentence because bounded events generally do not happen in the instant that is the UT.

2.2.4 Accounts for tenseless languages that are of controversial status

This section began with a review of a tensed account (Matthewson 2006) for the tenseless language Statimcets where a phonologically null [TENSE] feature present in the syntax indicates that sentences receive a non-future interpretation. It then surveyed tenseless accounts (Tonhauser 2011, Bittner 2005, Bohnemeyer 2009, Smith & Erbaugh 2005, and Mucha 2012, 2013) which lack any [TENSE] features and instead use temporal anaphora, aspectual information and pragmatic principles to obtain temporal interpretations. This section briefly examines three accounts (those of Lin 2006, 2010, Shaer 2003, and Ritter & Wiltschko 2005, 2009, 2014) that the authors consider to be tenseless accounts, because they do not propose any covert tense morphemes/tense features, but that others in the literature consider to be tensed accounts for various reasons.

Let us begin with Lin (2006, 2010) for Mandarin. Lin views his approach as a tenseless account because he does not have any covert tense morphemes. However, Matthewson (2006) and Tonhauser (2011) both consider his account to be tensed, presumably because Lin's entry for the perfective has past temporal semantics written into it, (67-a).

- (67) a. perfective aspect = $\lambda P_{\langle i,t \rangle}. \lambda t_{Top}. \lambda t_0. \exists t[t \subseteq t_{Top} \ \& \ P(t) \ \& \ t_{Top} \ i \ t_0]$
 b. progressive aspect = $\lambda P_{\langle i,t \rangle}. \lambda t_{Top}. \exists t[t_{Top} \subseteq t \ \& \ P(t)]$ (Lin 2006 p6: 8, p4: 5b)

As such, they argue that Lin's analysis is not tenseless; it just bundles tense and aspect together. In other words, one might say that Lin shifts the location of the [PAST] feature from T to Asp. Note that he does not write any temporal interpretation into his entry for progressive aspect, (67-a). Here one could say that in progressive sentences there is no [TENSE] feature present in the syntax and the temporal interpretations are obtained via one/some of the default processes mentioned in the previous section.

The particular formulation that Lin adopts is similar to that of Smith et al. (2003, 2007) in many ways. First, sentences with no aspectual marking, like those in (61), will obtain their viewpoint aspect via telicity: telic verbs will have a default perfective aspect while atelic verbs will have a default progressive interpretation in telicity dependent languages (Bohnenmeyer and Swift (2004)). Secondly, perfective verbs will receive a past tense interpretation via the entry for the perfective, (67-a). Progressive verbs will receive a default present tense interpretation, since matrix clauses are evaluated with respect to the UT, as (61-a) showed. As expected for a default, this present progressive interpretation can be overridden by past temporal adverbs, (62-a), which introduce an alternative TT to the context. This present default could be derived using the principles in (57) and (59) proposed by Smith et. al. (2007).

In a similar vein as Lin, Shaer (2003), focusing on Kalaallisut, questions whether there must be a one to one mapping between the syntax, morphology and semantics; in other words, must tense morphology/tense features be located at T. He argues that temporal semantics could, for both English and Kalaallisut, be obtained from the VP through a dynamic semantics approach based on Muskens (1995) and that TP is not needed for tense semantics/to host temporal morphology/features. Like Lin, Shaer simply shifts the location of the [TENSE] features. While he does not propose any covert tense morphemes, he proposes to put them at the VP-level via writing temporal meanings into lexical entries for verbs themselves.

The final account of controversial status in the ‘no overt morphology’ camp is that of Ritter and Wiltschko (2005), Wiltschko and Ritter (2010) and Ritter and Wiltschko (2014), which defines tense/tenselessness in relation to anchoring (i.e. what connects the event in a clause to the utterance context). Ritter and Wiltschko propose that all languages project an IP, which selects for other functional categories like AspP and is the syntactic locus of anchoring. Languages vary, however, with respect to the exact substantive content of Infl. In English, this substantive content is tense, in Blackfoot it is person and in Halkomelem it is location. What syntactically distinguishes tensed languages from tenseless ones is that the substantive content of Infl in a tensed language will be tense; where as in a tenseless one, it will be something else.

The substantive content of Infl is determined by looking at what type of contrastive morphological marking¹⁷ that a language has. This is formalized using a [*u*coincidence]-feature (in the sense of Hale (1986)) located at Infl. Since Halkomelem and Blackfoot do not have any overt tense morphology and they do not propose any covert tense morphology, they consider their account to be a tenseless account. However, Tonhauser (2011) considers their account as a tensed account, because these languages do have overt locative and person markers which check the [*u*coincidence]-feature and thus constrain temporal interpretations.

In Ritter & Wiltschko's system, languages obtain their temporal interpretation in three ways: i) valuation of the [*u*coincidence]-feature via the morphology representing the substantive content in Infl (deictic valuation), ii) real world knowledge given the valuation of the [*u*coincidence]-feature (deictic valuation) and iii) via default valuation of the [*u*coincidence]-feature in such atemporal contexts as counterfactuals (anaphoric valuation). Tensed languages obtain their temporal interpretation from i) and iii). Tenseless languages receive valuation via ii) and iii). An example of valuation via ii) follows: if a Halkomelem sentence has a distal morpheme that values the [*u*coincidence]-feature negatively and a 1st or 2nd person subject, the sentence must have a past interpretation since the same person cannot be in two places at once. Crucially, though, if there is a 3rd person subject, no such inferences can be drawn, and the sentence will be ambiguous between a present and a past interpretation.

This concludes the overview of the 'no overt morphology' camp. Those in this camp define tenselessness using morphological criteria. Specifically, a tenseless language is one which lacks overt morphology. This camp further bifurcates into those who assume a tensed account for tenseless languages and those who assume a tenseless account for tenseless languages. In a tensed account, the abstract, formal morphological [TENSE] feature is present in the syntax. It is simply not pronounced. On a tenseless account, a tenseless language lacks the abstract, formal morphological

¹⁷Here 'contrastive' means a feature that has content even if it is not marked in the morphology (i.e. there is some overt and opposite morphology that it contrasts with). In other words, in order for there to be a null INFL substantive content morpheme, say a null proximal locative marker, there must be an opposite overt marker such as an overt distal locative marker.

[TENSE] feature. In these languages, temporal interpretation is obtained via temporal anaphora, aspectual information and pragmatic principles.

2.2.5 ‘No TP’ camp

This section turns to the other component that could conceivably be missing: the syntactic component of tense, i.e. TP. Those taking this position, the no TP camp, include Bošković (2012) for Serbo-Croatian, Turkish, Japanese, a.o., Todorovic (2014) for Serbo-Croatian and Kang (2014) for Korean. The basic idea is that, typologically, languages which lack a DP tend to also lack its clausal counterpart, the TP. The basic idea is set forth in Boskovic's paper and extended and expanded in the Todorovic and Kang works. This camp assumes that properties linked with T will be absent in tenseless languages. For them the absence of EPP properties (such as the presence of *there* expletives), the presence of nominative as a default (as opposed to structural) case, evidence of lack of movement to Spec/TP (such as subject-object asymmetries in extraction), the absence of Sequence of Tense effects, the inability of CP to be a phase, allowance of null copulas in predicate nominative constructions and finiteness mismatches in VP ellipsis are all taken as evidence that a language lacks a TP.

With respect to the morphological component, there are suggestions that morphemes previously analyzed in some languages as tense morphemes are really aspect or agreement morphemes. However, for Boskovic and Kang, it is possible for a language to lack tense morphology and a TP yet still have an abstract, formal morphological feature in the syntax. Given the lack of T, Boskovic suggests that such a feature could be located at V, for example. In principle, this feature could have an overt or covert realization. For languages that lack this feature, Boskovic suggests that the semantics could be worked out using a system such as Lins (2006), and Kang (2014) works out a semantics along these lines for Korean. Notably, the account in Lin (2006) fits in the ‘no overt morphology’ camp in that its main diagnostic for a tenseless language is the lack of tense morphology. However, his account also fits in the ‘no TP’ camp. Lin, in his 2006 paper and especially in his more syntax-oriented 2010 paper, argues that Mandarin, as a tenseless language, must lack a TP, in addition to lacking covert

tense morphology.

Thus, in sum, for the ‘no TP’ camp, a tenseless language is one that lacks a TP. With respect to the morphological component, it can still have an abstract, formal morphological [TENSE] feature located on, say, V (or Asp), and this feature could have an overt or covert realization. This camp suggests that if a language lacks the abstract, formal morphological [TENSE] feature, an account like Lin (2006)’s could be formulated to account for the temporal interpretations of sentences in these languages.

2.3 Chapter summary

Section 1 of this chapter reviewed the basic syntax, morphology and semantics assumed for tense, aspect and the perfect. It assumed that tense, aspect and perfect all project their own projections and that the ordering of these projections is [TP [PerfP [AspP [vP [VP]]]]]. It also assumed that they each have the appropriate abstract, formal morphological [TENSE/PERFECT/ASPECT] feature. This feature is what communicates with the interpretive component and can have either an overt or covert realization. Following Klein (1994), and many others, tense was defined as the relationship between the Topic Time and the Utterance Time. (Viewpoint) aspect was defined as the relationship between the Situation Time and the TT. Both tense and (viewpoint) aspect are properties of clauses. Lexical aspect/aktionsart, however, is a property of individual predicates and provides further information about the type of event occurring. Two potential ways of formalizing tense semantics, namely a pronominal account (Partee 1973, Kratzer 1998, a.o.) and a quantificational account (Prior 1967, Ogihara 1989, Kusumoto 1999, Beck & von Stechow 2015, a.o.), were briefly explained. Either account will do for the purposes of this thesis. The imperfective paradox was then briefly explained and used to motivate a modal account of the progressive (Dowty 1979, Beck & von Stechow 2015, a.o.). A Perfect Time Span account of the perfect (Iatridou et. al. 2003; Pancheva 2003, 2013, a.o.) was then motivated and the formalization of that account provided in Pancheva (2003)

adapted.

Section 2 examined the question of what it means to be a ‘tenseless’ language. All parties involved agree that all languages have a way to express the semantic component of tense. Instead, tenseless languages are ones in which part or all of (both) the morphological or syntactic components of tense are missing. Languages reported to be tenseless include Hausa, Yukatek Maya, Paraguayan Guarani, Navajo, Blackfoot, Halkomelem, St’at’imcets, Kalaallisut, Serbo-Croatian, Japanese, Korean, Mandarin, and Turkish.

Two definitions for ‘tenselessness’ were then provided based on the camps present in the literature. For a tenseless analysis in the ‘no overt morphology’ camp, being ‘tenseless’ means one of two things. On a tensed account like Matthewson (2006), tenseless languages are simply missing overt tense morphology but have the abstract, formal morphological [TENSE] feature. On a tenseless account, that the language lacks the formal, abstract morphological feature and thus has neither overt nor covert tense morphology (Tonhauser 2011, Bittner 2005, Bohnemeyer 2009, Smith et. al. 2003, 2007, Smith & Erbaugh 2005, and Mucha 2012, 2013). These researchers suggest that when a language lacks [TENSE] features, other mechanisms like pragmatic factors, temporal anaphora and aspectual specification, are used to express the relationship between TT and UT. Analyses in the ‘no overt morphology’ camp that are of controversial status in the literature include Lin (2006, 2010) and Shaer (2003), where the location of the abstract tense features is shifted from T to Asp or V. Another account of controversial status is that of Ritter & Wiltschko (2005, 2009, 2014) who claim that tenseless languages are those in which anchoring is done using a deictic category other than tense. This category will have its own morphological marking and a corresponding formal feature occurring at the general head Infl.

For those in the ‘no TP’ camp, the defining characteristic of a tenseless language is that it lacks a TP. With respect to the morphological component, it can still have an abstract, formal morphological [TENSE] feature located on, say, V (or Asp), and this feature could have an overt or covert realization. This camp suggests that if a language lacks the abstract, formal morphological [TENSE] feature, an account

like Lin (2006)'s could be formulated to account for the temporal interpretations of sentences in these languages.

The next chapter will show that Malayalam is empirically different from the tenseless languages described in this chapter.

Chapter 3

Tense & Aspect in Malayalam

In the literature, the investigation of the tense/aspect system in Malayalam focuses almost exclusively on whether or not Malayalam has a TP in its clausal structure and what the role of the morphology is in drawing this conclusion. On one side, Amritavalli & Jayaseelan (2005), Amritavalli (2014), and Jayaseelan (2014)¹ claim that Malayalam, as well as the other major Dravidian languages Kannada, Telugu and Tamil, lacks tense morphology and a TP and does not use tense to anchor clauses. This is not a priori impossible as a diverse number of languages have been argued to lack tense morphology and/or a TP cross-linguistically, as discussed in the previous chapter.

However, this position is a controversial and novel claim for Malayalam. Grammars have long claimed that Malayalam has tense morphology (Gundert 1851, Caldwell 1856, Peet 1860, Frohnmeyer 1913, Raja Raja Varma 1917, Asher & Kumari 1997, a.o.) and Hany Babu & Madhavan (2003) and Menon (2011) have argued in favor of Malayalam having a TP in the syntax. This chapter will argue, along with the grammars and Hany Babu & Madhavan (2003) and Menon (2011) that Malayalam has tense morphology. Chapter four will also show that Amritavalli & Jayaseelans arguments that Malayalam lacks a TP are not conclusive.

¹Throughout the thesis Amritavalli & Jayaseelan (2005), Amritavalli (2014), and Jayaseelan (2014) will be references as a single account since the 2014 papers simply offer further evidence for the account put forth in the 2005 paper. It will be specifically noted in cases where the papers differ from one another.

However, while this thesis argues that Amritavalli & Jayaseelan are wrong in calling Malayalam a tenseless language, they are right in their intuition that the tense/aspect/perfect system in Malayalam, is, in some ways, very different from that of English. The next page or so will provide a brief overview of their proposal. Amritavalli & Jayaseelan (2005) rely heavily on negation data and on intra-Dravidian comparison, particularly with Kannada, to build their claim that Malayalam is a tenseless language. One goal of their proposal is to provide a unified clause structure for positive and negative sentences across Dravidian.

Amritavalli & Jayaseelan begin with a puzzle from Kannada. Negative root clauses in Kannada do not contain finite verbs, i.e. verbs with tense and agreement morphology². Instead, Kannada uses ‘non-finite’ forms in negative clauses. The gerund is used in negative root clauses to express present tense, (2-a). Infinitives are used to express past tense in negative root clauses, (2-b). Here some other marking, namely that of infinitives and gerunds, seems to be controlling tense interpretation in Kannada negative clauses.

- (1) a. avanu bar-utt-aanne.
 He come-PRES-3MSG
 ‘He comes.’
- b. avanu ban-d-anu.
 He come-PAST-3MSG
 ‘He came.’
- (2) a. avanu bar-uvud(u) illa.
 he come-gerund NEG
 ‘He does not come.’
- b. avanu bar-al(u) illa.
 He come-INF NEG
 ‘He did not come.’ (Amritavalli & Jayaseelan 2005: 3, p181)

Since these root negative clauses should be just as ‘finite’ as their positive counterparts, (1), which have tense and agreement marking, Amritavalli and Jayaseelan

²Unlike Malayalam, Kannada has verbal agreement morphology, as seen in (1). The other major literary Dravidian languages Tamil and Telugu also have verbal agreement morphology.

suggest that the negation, *illa*, itself incorporates ‘finiteness.’ Perhaps this could be understood to mean that *illa* is a negative ‘finite’ verb. Since *illa* does not contain either tense or agreement marking, they conclude that tense and agreement cannot be what makes a verb ‘finite’ in Malayalam; something else must be responsible for marking the verb as being ‘finite.’

In searching for a possible candidate, they note that modals, like *illa*, take infinitival complements in Kannada. Modals, like the ‘finite’ verbs in (1), also cannot co-occur with *illa*; instead they have dedicated negative counterparts. Based on these parallels, they argue that what makes both *illa* and modals ‘finite’ is mood³ and that both modals and *illa* target a single projection in the syntax, MoodP. Amritavalli (2014) further explains that this means for them that the clause is anchored to the utterance via worlds, which is a possibility in line with the proposal in Ritter & Wiltschko (2005, 2009). They further argue that agreement is a reflex of indicative mood, and thus provide a unified ‘finiteness’-as-mood account for both positive and negative root sentences. Why the assumption is made that there is a link between agreement and indicative mood is not clear to me, since languages like Spanish and Ancient Greek show agreement in the subjunctive mood (and optative in Ancient Greek), in addition to the indicative mood. In sum, for Amritavalli and Jayaseelan, what makes a verb ‘finite’ is the relationship it has with MoodP not TP. This is a reflection of their main insight: tense and ‘finiteness’ are separate notions in Dravidian. This is the first part of their account.

The second part of their account argues that tense marking in positive root clauses cannot actually be tense marking; otherwise it would cause a verb to be ‘doubly marked’ for ‘finiteness,’ here assuming that finiteness is a property of individual verbs, since this is where the relevant morphology appears.⁴ To avoid this problem, they propose that all morphemes previously analyzed as tense morphemes are actually

³I think that what is mainly meant by ‘mood’ is ‘modality,’ as cases involving modals are what are discussed in the Amritavalli and Jayaseelan papers, not cases involving other moods than the indicative. Malayalam, for instance, does not have a subjunctive mood (Jayaseelan 1999).

⁴I will point out below that this issue of being being ‘doubly marked’ for ‘finiteness’ does not actually take their first conclusion, that tense and ‘finiteness’ are separate notions in Dravidian, seriously.

aspect morphemes. Then, since the language now lacks tense morphemes, they assert that there is no longer any need for a TP in the syntax.

Temporal semantics are then to be obtained as follows: when an infinitive is in the scope of MoodP, it yields a past tense interpretation and when a gerund is in the scope of MoodP, it gives a present tense interpretation. How exactly the semantics would work is not spelled out beyond a suggestion in Amritavalli (2014) that something along the lines of the system in Lin (2006) might work.

Amritavalli and Jayaseelan argue for this same system in Malayalam by pointing out that, while it uses fully inflected regular verb forms in both positive and negative sentences, unlike Kannada, it, nonetheless, appears to have finite and non-finite negation forms. Example (4) shows that the finite negation in Malayalam regular verbs is also *illa*. Modals in Malayalam, as in Kannada, are defective and have their own negative forms that are not inflected for tense and take infinitival complements, (3).⁵ They take this as evidence that Malayalam, like Kannada, encodes ‘finiteness’ as mood and that *illa*, along with modals located in MoodP, serve as ‘finiteness’ markers. Note that Malayalam, unlike Kannada and the other Dravidian languages, lacks agreement morphology.

(3) avan var-uka-(y)ee veenda
 he come-INF-EMPH need.NEG
 ‘He need not come at all.’ (Amritavalli & Jayaseelan 2005 p201: 41)

(4) avan var-unn-illa
 he come-PRES-NEG
 ‘He is not coming/he does not come.’ (Amritavalli & Jayaseelan 2005 p181: 4a)

Turning to negative clauses in Malayalam like those in (4), which contain both tense marking and the finite negation, *illa*, they argue that the problem of having ‘double finiteness marking’ again occurs if tense markers are also ‘finiteness’ markers in Malayalam. To remedy this, they reanalyze tense marking as aspect marking. Since, Malayalam no longer has tense morphology, they argue that it no longer has need

⁵In the positive sentence the form of the modal would be *veenam*.

of a TP to host that morphology.⁶ In negative clauses, *illa* is the finite element. In positive clauses, they propose that, parallel with Kannada, agreement is the finite element. However, unlike Kannada, Malayalam does not have verbal agreement. As such, a null agreement marker is proposed to exist in Malayalam positive clauses. Agreement, modals and *illa* occur in MoodP. In Malayalam then, temporal interpretations would be obtained as follows: perfect(ive) aspect in the scope of a finiteness element yields past tense and imperfective aspect in the scope of a finiteness element yields present tense.

One of the first problems for Amritavalli & Jayaseelan’s account is that this supposed problem of being ‘doubly marked’ for ‘finiteness’ does not actually take their first conclusion seriously. Namely, if tense is not a ‘finiteness’ marker in Dravidian, then it should be able to co-occur in a clause with mood (modal) marking or its reflex, agreement, without causing any problems of ‘double finiteness marking.’ Perhaps Amritavalli and Jayaseelan might try to explain away this problem by saying that what counts as ‘finiteness’ marking in a given language is subject to parametric variation. Even if this is so, it still does not take their claim that ‘finiteness’ does not equal tense in Dravidian seriously.

It is possible to accept Amritavalli and Jayaseelan’s assertion that ‘finiteness’ is not linked to tense in Dravidian without accepting their second claim that Dravidian languages lack tense morphology and a TP. The first part of this chapter will show that while Amritavalli & Jayaseelan’s first assertion could be true, the second part is not empirically supported. The first half of this chapter shows that Malayalam is empirically different from the tenseless languages surveyed above. To begin with, unlike Paraguayan Guarani, Navajo, Blackfoot, Halkomelem, St’at’imcets, and Mandarin, matrix sentences with verbs not marked with tense morphology are not allowed. Secondly, Malayalam does not allow adverbs or contextually salient TTs to override the temporal interpretations provided by the tense morphemes. Additional arguments

⁶Jayaseelan (2014) argues that MoodP is part of an expanded CP-level. Below MoodP there is an IP which hosts the subject in its specifier position. He still maintains though that IP is not TP and that Malayalam is a tenseless language (no TP, no tense morphology, no anchoring via tense). This raises interesting questions regarding the role of IP vs TP, which will be taken up in chapter 4.

against a tenseless account come from the formation of the Universal Perfect and the ‘second’ imperfective and the distribution of auxiliaries. The second half of the chapter sketches the beginning of a tensed analysis for the tense and aspect system in Malayalam. In doing so, it shows the difference between what have been called the two ‘imperfectives’ in Malayalam and also offers an in depth investigation of copula selection in Malayalam.

3.1 A complex puzzle

Let us begin by appreciating the difficulty of the task. Questions about the morphosemantics of tense and aspect in Malayalam are complicated for two reasons. The first is that, as will be shown, the exact meanings of the morphemes expressing tense are not always clear. Part of the problem is that, due to widespread sandhi, it is often difficult to figure out where morphemes begin and end. The second is that in the midst of the controversy over whether or not Malayalam is tenseless, the semantic terms have not been well-defined and the full tense and aspect paradigms have not been considered. The tense paradigm, with the verb *var-* ‘come’, used by Amritavalli & Jayaseelan to build their analysis is presented in the leftmost column of 3.1. The middle column shows the traditional tense labels.⁷ The rightmost column shows the new labels Amritavalli & Jayaseelan argue for.⁸

Morphology	traditional	Amritavalli & Jayaseelan
var- unnu	present	imperfective
vann- u	past	perfective/perfect

Table 3.1: Hypotheses for the meanings of *-unnu* and *-u*

The presentation of the facts in 3.1 is actually somewhat misleading as it is incomplete, in the sense that, as was shown in chapter 2, to convey the temporal

⁷Gundert (1851), Caldwell (1856), Peet (1860), Frohnmeyer (1913), Raja Raja Varma (1917), Asher & Kumari (1997), Hany Babu & Madhavan (2003), Menon (2011), a.o.

⁸Amritavalli & Jayaseelan (2005) and Jayaseelan (2014) use the terms ‘perfective’ and ‘perfect’ interchangeably. Following the semantics literature, this thesis assumes the distinct definitions given in chapter 2. The rest of the dissertation provides arguments that the *u* is neither a perfective nor a perfect marker; it is simply past tense marking.

interpretation of a sentence, both tense and aspect are needed. The basic tense and aspect combinations are given in 3.4. The tense forms of imperfective 1 can be created by adding *-unnu* to the verb stem and then using the appropriate tense form of the *undu* copula.⁹ To create the tense forms of 'imperfective 2',¹⁰ *-uka* is added to the verb stem and the appropriate tense form of the *aanu* copula is added. Perfective forms are created by adding the traditional tense markers to the verb.¹¹ Examining the paradigm as a whole will help us gain a more complete perspective on tense and aspect in Malayalam.

-	Imperfective 1	'Imperfective 2'	Perfective
Present	var- unnu (<i>undu</i>)	var-uka(y) <i>aanu</i>	—
Past	var- unnu <i>undaayirunnu</i>	var-uka(y) <i>aayirunnu</i>	vann-u
Future	var- unnu <i>undaayirikkum/undaakum</i>	var-uka(y) <i>aayirikkum</i>	chirikk-um

Table 3.2: Full tense/aspect paradigm for *var-* 'come'

Table 3.4 shows that things immediately look more complicated for a tenseless analysis than the paradigm in 3.1 suggests. In both the 'imperfectives,' auxiliaries with tense marking appear. This is puzzling for an account that claims Malayalam lacks tense morphology and instead simply 'reads tense off' of aspect in the presence of mood. One might try to counter that these auxiliaries could actually be analyzed as being some type of 'compound' verbs themselves. Notice that the past and future auxiliaries end with the past and future 'perfective' forms, *irunn-u* and *irikk-um* respectively, of the verb in 3.3. This verb, in addition to being frequently used with its lexical meaning, also has a number of uses as an auxiliary, light verb and 'do' support. Its use will be discussed in chapter 5. Further notice that the auxiliary verb used in the past and the first future forms of 'imperfective' 2 is added to *und-* to form the auxiliary verb in imperfective 1.

Whatever answer that might be propose for the fascinating puzzle regarding the

⁹Adding *undu* in the present gives an emphatic (do-support) feel, i.e. a type of verum focus. In normal speech, the final *u* in *unnu* is dropped to give *varunnundu(aayirunnu/undaa(yirik)kum)*.

¹⁰It will be argued in the second part of this chapter that 'Imperfective 2', in line with the intuition in Hany Babu & Madhavan (2003) is simply a progressive, not an imperfective.

¹¹In some verbs the past perfective form ends in *i*, e.g. *pook*- 'go' has *pook-unnu (undu)* as its present imperfective 1 and *pooy-i* as its past perfective form. This alternation does not seem to be phonologically conditioned. See Appendix B.

Tense	Imperfective 1	‘Imperfective’ 2	Perfective
Present	irikk- unnu (<i>undu</i>)	irikk-uka(y) <i>aanu</i>	—
Past	irikk- unnu <i>undaayirunnu</i>	irikk-uka(y) <i>aayirunnu</i>	irunn-u
Future	irikk- unnu <i>undaayirikkum/undaakum</i>	irikk-uka(y) <i>aayirikkum</i>	irikk-um

Table 3.3: Tense/aspect forms of *irikk-* ‘sit’

nature of the auxiliary verbs, the next section will argue that a tenseless account for Malayalam is not tenable. The next section will argue that Amritavalli & Jayaseelan are right in saying that *unnu* is an imperfective marker but wrong in reanalyzing the traditional past tense marker as a perfective/perfect. Instead, it argues that it is simply a past tense marker. It also argues that Malayalam has a null present tense morpheme. Although it is argued below that Amritavalli & Jayaseelan are not right about Malayalam being tenseless, they are right in observing that the tense and aspect system in Malayalam is more complex than it seems at first glance. The second half of this chapter will also illustrate this point as well with respect to the two ‘imperfectives.’

3.2 Malayalam is not a tenseless language

Recall from the previous chapter that researchers use the term ‘tenseless’ in different ways. For some this means that a language lacks overt tense morphology (Matthewson 2006), both covert and overt tense morphology (Tonhauser 2011, Bittner 2005, Bohnemeyer 2009, Smith et. al. 2003, 2007, Smith & Erbaugh 2005, Lin 2006, 2010, and Mucha 2012, 2013), that it lacks a TP (Boskovic 2012, Kang 2014, Todorovic 2014, Lin 2010) or that something other than tense serves as the anchor (Ritter & Wiltschko 2005, 2009, 2014). Despite the disagreement, there seem to be some empirical commonalities that tenseless languages, at least on the semantic and anchoring definitions share. Namely, in Paraguayan Guarani, Navajo, Blackfoot, Halkomelem, St’at’imcets, and Mandarin, matrix sentences with verbs not marked with tense morphology are allowed. Secondly, many tenseless languages allow contextually salient TTs (and sometimes just adverbs) to override the temporal default interpretations

provided by other morphemes. Something like this would be necessary to explain how Malayalam has the full range of tense and aspect combinations under Amritavalli & Jayaseelan’s system.

It will be shown in this section that Malayalam does not have either of these properties. Further arguments against a tenseless account come from the formation of the Universal Perfect and the ‘second’ imperfective and the distribution of auxiliaries. It will be shown in chapter 4 that Amritavalli & Jayaseelan’s arguments that Malayalam lacks a TP are, at best, not conclusive.

3.2.1 Applying the tests to the imperfective morphologies

This section examines the argument that *unnu* is an imperfective marker that can yield a default present reading. It begins by sketching why Amritavalli and Jayaseelan probably reached the conclusion that *unnu* is an imperfective marker. It ultimately argues that they are right in concluding that *unnu* is an imperfective marker, though they are wrong in arguing that it yields a default present tense (or alternately, that it is a form that bundles imperfective aspect and present tense).

It is quite probable that knowledge of the paradigm in 3.4, repeated below, though not spelled out in any of their papers, is one of the reasons they argue that *unnu* is an imperfective marker.

-	Imperfective 1	‘Imperfective 2’	Perfective
Present	var- unnu (<i>undu</i>)	var-uka(y) <i>aanu</i>	—
Past	var- unnu <i>undaayirunnu</i>	var-uka(y) <i>aayirunnu</i>	vann-u
Future	var- unnu <i>undaayirikkum/undaakum</i>	var-uka(y) <i>aayirikkum</i>	chirikk-um

Table 3.4: Tense/aspect paradigm for *var-* ‘come’

Specifically, like an imperfective marker, the same *unnu* verb can be used to express both the progressive (*njaan var-unnu* ‘I am coming (right now)’) and the generic (*njaan var-unnu* ‘I come (in general)’). Looking at the past and future forms of imperfective 1, as shown in Table 3.4, we see that an *unnu* marked verb is a component of both the past and the future imperfective. If *unnu* were genuinely a present tense marker, this would be surprising. However, if *unnu* is an imperfective

marker used with an auxiliary verb that encodes tense semantics, then its use in all tenses of the imperfective is not surprising. From here on out, this thesis will follow Amritavalli and Jayaseelan and gloss *unnu* as the imperfective.

Given the acceptance of *unnu* as an imperfective marker, the question now is, does *unnu* simply receive a default present tense in the absence of a temporal auxiliary?¹² If this were so, this default present tense would be expected to be overrideable by things like past tense adverbs or context, as in Mandarin and Hausa. This would then result in a past imperfective meaning. The Mandarin data in (5) provides an informal illustration of how this process would work. The sentence in (5a) has a present interpretation when uttered in an out-of-the-blue context because the sentence has imperfective aspect obtained via the default telicity principle spelled out in Lin (2006). However, when a past adverbial is added to the same sentence, (5-b), the default present is overridden to yield a past tense meaning.

- (5) a. Wo zhu zai Lutedan.
 I live in Rotterdam
 ‘I live in Rotterdam.’ (#‘I lived in Rotterdam’ when uttered in isolation.)
- b. Wo 1989 nian zhu zai Lutedan.
 I 1989 year live in Rotterdam
 ‘I lived in Rotterdam in 1989.’ (Lin 2010, p307: 3)

Now turning to Malayalam, we see in (6) that the facts here are different. Only the ‘traditional’ past tense form of the verb, *thamasicch-u*, is compatible with the past tense adverbial ‘in 1966.’ The *unnu* is not licit with the past tense adverbial, contrary to what a default tense analysis like Lin’s (2006) would predict.

- (6) njaan aayiratthi tollaayiratthi arupatthi aar-il Koch-il
 I thousand nine.hundred sixty six-LOC Kochi-LOC
 {thamasicch-u, *thamasikk-unnu, *thamasikk-uka(y)-aanu, *thamasikk-um}
 live-PAST live-IMPV1 live-IMPV2-be.PRES live-FUT
 ‘I lived in Kochi in 1966.’

¹²These auxiliaries are not indicators of mood. The only auxiliary with any modal flavor is the future one which contains the future/modal marker *um*.

This pattern holds with other types of verbs and adverbs as well. The sentence in (7) uses the telic achievement predicate *jayikk-* ‘win’ and (8) uses the stative predicate *peedikk-/peedi var-* ‘be afraid/scared.’¹³ These sentences show that a past tense adverb like *innale* ‘yesterday’ is only compatible with the traditional past tense marked verb, *jayicch-u* and *peedicch-u*, respectively.

- (7) innale njaan {jayicch-u, *jayikk-unnu, *jayikk-uka(y)-aanu,
yesterday I win-PAST win-IMPV1 win-IMPV2-be.PRES
*jayikk-um}
win-FUT
‘Yesterday I won.’
- (8) a. njaan innale vaikunneeram {peedicch-u, *peedikk-unnu,
I yesterday evening fear-PAST fear-IMPV1
*peddikk-uka(y)-aanu, *peedikk-um}
fear-IMPV2-be.PRES fear-FUT
‘I was scared/afraid yesterday evening.’
- b. *enikku innale vaikunneeram peedi var-unnu
I.DAT yesterday evening fear come-IMPV1
‘I was scared/afraid yesterday evening.’

These facts also hold for embedded clauses. Just as in root clauses, a past adverb cannot override the default present tense that would be obtained from the imperfective aspect. Here only the traditional past tense form, *jayicch-u*, is possible.

These facts also hold for embedded clauses. Just as in root clauses, a past adverb cannot override the default present tense that would be obtained from the imperfective aspect. Here only the traditional past tense form, *jayicch-u*, is possible.

- (9) a. [innale njaan {jayicch-u, *jayikk-unnu, *jayikk-uka(y)-aanu,
yesterday I win-PAST win-IMPV1 win-IMPV2-be.PRES
*jayikk-um} ennu] vinu viccharicch-u
win-FUT COMP Vinu think-PAST
‘Vinu thought that yesterday I won.’
- b. [innale njaan {jayicch-u, *jayikk-unnu, *jayikk-uka(y)-aanu,
yesterday I win-PAST win-IMPV1 win-IMPV2-be.PRES

¹³For some reason the present tense of *peedikk-*, *peedikk-unnu*, is not possible when *ippum* is added; the compound form must be used in this case. Without the adverb, *peedikk-unnu* is fine. The explanation for this alternation is left to further research.

*jayikk-um} ennu] vinu viccharikk-unnu
 win-FUT COMP Vinu think-IMPFV1
 ‘Vinu thinks that yesterday I won.’

Additionally, future adverbs cannot occur with *unnu*, or the traditional past tense, (10). Either the simple future form, *-um*, or the periphrastic going to future is required. Imperfective 2 can also be used here on a futurate reading in say, a situation where an optimist claims that tomorrow he will win, despite having failed in previous attempts. Section 3.5 argues that the ability of imperfective 2 to get futurate readings while imperfective 1 cannot falls out from their different semantics.

- (10) naale njaan {jayikk-um, jayikk-aan pook-unnu,
 tomorrow I win-FUT win-INF go-IMPFV1
 jayikk-uka(y)-aanu, *jayikk-unnu, *jayicch-u}
 win-IMPFV2-be.PRES win-IMPFV1 win-PAST
 ‘Tomorrow I will win/am going to win.’

The same facts hold for stative predicates like *peedikk-/peedi var-* ‘be afraid/scared.’

- (11) a. njaan naale raavile {peedikk-um, *peedicch-u}
 I tomorrow morning fear-FUT fear-PAST
 ‘I will be scared/afraid tomorrow morning.’
 b. *enikku naale raavile peedi var-unnu
 I.DAT tomorrow morning fear come-IMPFV1
 ‘I will be scared/afraid tomorrow morning.’

This data strongly argues against a Mandarin-style default tense analysis, where past tense adverbs can override the present temporal defaults that would be gained from imperfective aspect, for the imperfective marker *unnu* in Malayalam. One might try to rescue the default tense analysis by appealing to the context override system in Hausa. Mucha (2012, 2013) points out that in Hausa the default temporal interpretations obtained from the morphologically marked aspect are strong enough that adverbs alone cannot override them. However, Mucha shows that contexts can override the default interpretations in Hausa. In (12a) a sentence with progressive marked aspect receives a default present interpretation in an out-of-the-blue context. Unlike in

Mandarin, the presence of a past time adverbial in an out-of-the-blue context with a progressive marked sentence only marginally yields a past tense interpretation in Hausa, (12-b). However, when an additional context question like that given in above (13) is added, a progressive marked verb can receive a past tense interpretation.

- (12) a. Ali yana wasa
 Ali 3SG.M.PROG play
 ‘Ali is playing.’
- b. ??yana wasa jiya.
 3SG.M.PROG play yesterday
 ‘He was playing yesterday.’

Context question: What was Hasan doing when Ali entered his house yesterday?

- (13) Lokacin da Ali ya zo, Hasan yana wasa.
 When Ali 3SG.M.REL.PFV come Hasan 3SG.M.PROG play
 ‘When Ali came, Hasan was playing.’ (Mucha 2012, p195-196: 17, 21)

However, these facts do not replicate in Malayalam. Example (14) shows that, unlike Hausa, a past tense context question, (14a), cannot override the default present interpretation that would be obtained from the imperfective, (14). Instead, one of the past imperfective verbs must be used here.¹⁴

- (14) a. Dileepu innale viid-il vann-appool Vinu endu
 Dileep yesterday house-LOC come.PAST-at.that.time Vinu what
 cheyy-uka(y)-aayirunnu?
 do-IMPFV2-PAST
 ‘What was Vinu doing when Dileep came to his house yesterday?’
- b. Dileepu vann-appool Vinu {kalikk-unn-undaayirunnu,
 Dileep come.PAST-at.that.time Vinu play-IMPFV1-be.PAST
 kalikk-uka(y)-aayirunnu, *kalikk-unnu, *kalikk-uka(y)-aanu}
 play-IMPFV2-be.PAST play-IMPFV1.PRES, play-IMPFV2-be.PRES
 ‘When Dileep came, Vinu was playing.’

¹⁴IMPFV 2 is the best form to use in a situation like (14) and also (17), as speakers frequently comment that it is the best form to use in response to a question (what many speakers call a second person answer). IMPFV1 is used to give a report to someone else (what many speakers call a third person answer). There will be further discussion of these facts in the next section.

In Hausa, progressive marked verbs are not compatible with future adverbs, (15), but if the progressive marked sentence with a future adverb is put in the right context, (16), it is grammatical.

- (15) #Tana wasa gobe.
 3.SG.F.PROG play tomorrow
 ‘She will be playing tomorrow.’ (Mucha 2012 p195: 18)

Context question: What will Ali be doing when I come home tomorrow?

- (16) Ali yana wasa gobe.
 Ali 3SG.M.PROG play tomorrow
 ‘Ali will be playing tomorrow (.when you come).’ (Mucha 2012 p197: 24)

However, once again, the Malayalam facts are different. Example (17) shows that a future context question cannot override the proposed default present interpretation that would be obtained from the imperfective *unnu* marking in Amritavalli & Jayaseelans system. Here the future would need to be used.

- (17) a. njaan naale viit-il varum-bool vinu endu
 I tomorrow house-LOC come.FUT-when Vinu what
 cheyy-uka(y)-aayirikkum?
 do-IMPFV2-be.FUT
 ‘What will Vinu be doing when I come home tomorrow?’
 b. Vinu naale {kalikk-uka-y-aayirikkum, kalikk-unn-undaayirikkum
 Vinu tomorrow play-IMPFV2-be.FUT play-IMPFV1-be.FUT
 *kalikk-unnu, *kalikk-uka(y)-aanu}
 play- IMPFV1-PRES play-IMPFV2-be.PRES
 ‘Vinu will be playing tomorrow.’

The fact that neither adverbs nor context can override the proposed default present tense obtained from the *unnu* imperfective suggests that, in fact, no such default present tense is available.

We might also think that Malayalam simply bundles present and imperfective together and expresses them as *unnu*. However, recall that *unnu* is used in the present, past and future forms of imperfective 1. This argues against such an analysis. A plau-

sible hypothesis at this point is that Malayalam has a null present tense morpheme that locates the utterance time as a subset of the topic time. An overt correlate of this generally null present tense marker is the present auxiliary *undu*.

The next section offers evidence from the adverb and contexts tests, used in this section, as well as additional arguments from imperfective 2, universal perfects, and auxiliary selection to argue that the traditional past tense morpheme is, in fact a past tense morpheme, not a perfect or perfective morpheme. Amritavalli & Jayaseelan’s arguments for reanalyzing the past tense marker as a perfective/perfect marker, namely Conjunctive/Adverbial Participle Constructions/Serial Verb Constructions, so called ‘gerunds’ and negation facts, will be examined in chapter 4.

3.2.2 Applying the tests to the past morpheme

Turning now to the *u/i* morpheme, this section argues that it indeed is just a past tense marker, following the traditional intuitions. The argument begins with the adverb and context tests used in the previous section. That section showed that when past tense adverbs like *innale* ‘yesterday’ and *aayiratthi tollaayiratthi arupatthi aar-il* ‘in 1966’ occur in a sentence, only the past tense *u/i* form is licensed. Example (18) show that the present adverb *ippum* ‘now’ can only be used with the past and future forms when the ‘now’ is in the preceding or upcoming second. As such, this parallels English sentences like *I won (just) now*, and *I will/am going to win now* (said just before putting an opponent in checkmate in a game of chess).

- (18) a. *ippum njaan {jayikk-uka(y)-aanu, jayikk-unnu-∅}*
 now I win-IMPFV2-be.PRES win-IMPFV1-PRES
 ‘Now I am winning.’
- b. *ippum njaan jayicch-u*
 now I win-PAST
 ‘I (just) won.’ #‘I am winning.’
- c. *ippum njaan {jayikk-um, jayikk-aan pook-unnu-∅}*
 now I win-FUT win-INF go-IMPFV1-PRES
 ‘I will/am going to win now.’ #‘I am winning.’

Again, the same facts hold for stative predicates like *peedikk-/peedi var-* ‘be afraid/scared.’ In (19) *ippum* ‘now’ can be used with the future tense when it conveys ‘I will be afraid in the upcoming instant’ and with the past tense when it means ‘Just a second ago, I was afraid.’ Neither the past nor the present can be used with *ippum* ‘now’, however, to mean ‘I am scared/afraid right now.’

- (19) a. enikku ippum peedi var-unnu-∅.
 I.DAT now fear come-IMPV1-PRES
 ‘I am scared/afraid right now.’
- b. njaan ippum {peedicch-u, peedikk-um}
 I now fear-PAST fear-FUT
 ‘I {was afraid a second ago, will be afraid in the upcoming instant.}’

Thus present adverbs are no more able to override the past or future defaults than mismatching adverbs can with the imperfective forms. Examples (20) and (21) also show that, unlike their Hausa counterparts in (23) and (24), that present and future contexts are not able to override the past tense semantics of *u/i*. Example (20) shows that a future context cannot override the default past interpretation that would be obtained from the perfective/perfect verb in Amritavalli and Jayaseelan’s system. Likewise, (21) shows that a present context cannot override their proposed past temporal default.¹⁵

- (20) a. inu rathri njaan kunjun-u bakshanum kodukk-aam-oo?
 today night I baby-DAT food give-MOD-Q
 ‘Am I supposed to feed the baby tonight?’
- b. nii varum-bool eekku, kunju {urang-irikk-um, *urang-i}
 You come.FUT-when by.then baby sleep-irikk-FUT sleep-PAST
 ‘When you arrive, the baby will already be asleep.’
- (21) a. enikku bhayangramaayi veshikk-unnu-∅! Enikku kazhikk-uvaan
 I.DAT great hunger-IMPV1-PRES I.DAT take-INF
 valladu und-oo?
 anything be-Q
 ‘Im starving! Is there anything to eat?’

¹⁵See Chapter 4 for more information on the Conjunctive/Adverbial Participle, glossed as -PART in (21-b)

- b. Juhī ippum kappa {paakam cheyth-u
 Juhī now tapioca cook do-PARTfinish-NOMLZ-EMP
 kazhinj-ath-ee ull-uu, *paakam cheyth-u}
 be-EMP cook do-PAST
 ‘Juhī has cooked (finished cooking) kappa now.’

These Malayalam facts are different from the Hausa ones, (23) and (24), where these contexts do allow for the perfective marked sentences to receive future and present meanings, despite their default past tense meanings, (22).

- (22) a. Ali ya yi wasa.
 Ali 3SG.M.PFV do play
 ‘Ali played.’
- b. #Hawwa ta dafa wake yanzu
 Hawwa 3.SG.F.PFV cook beans now
 ‘Hawwa cooks/has cooked beans now.’
- c. #Hawwa ta dafa wake gobe.
 Hawwa 3SG.F.PFV cook beans tomorrow
 ‘Hawwa will cook beans tomorrow.’ (Mucha 2012 p195: 16, 19-20)

Context question: Am I supposed to feed the baby tonight?

- (23) Kafin ka iso jaririn ya yi barci
 Before 2SG.M.SBJV arrive baby.DEF 3SG.M.PFV do sleep
 ‘When you arrive, the baby will already be asleep.’

Context question: I’m starving, is there anything to eat?

- (24) Hawwa ta dafa wake yanzu
 Hawwa 3SG.F.PFV cook beans now
 ‘Hawwa has cooked (finished cooking) beans now.’ (Mucha 2012 p196-197:
 25-22)

Amritavalli and Jayaseelan are not clear about whether they are reanalyzing the traditional past tense as a perfective or a perfect marker. The fact that *ippum* ‘now’ cannot be used with the present perfect, (21-b), perhaps suggests that traditional past tense morphology should not be reanalyzed as perfect morphology, since present

adverbs can occur with present perfect verbs in English and with perfect verbs in Korean, even though in Korean, perfect marked verbs have default past interpretations, (25).

- (25) a. John-un hakkyo-ey ka-ss-ta
 John-TOP school-LOC go-PERFECT-DECL
 ‘John went to school.’
- b. John-un cikum hakkyo-ey ka-ss-ta
 John-TOP now school-LOC go-PERFECT-DECL
 ‘John has gone to school now.’ (Kang 2014, p75: 61)

Based on these tests, it looks like *u/i* is simply a past tense marker and not a perfective or perfect marker. However, a few caveats are in order. First, adverbs meaning ‘now’ do not always refer to the utterance time but can also refer to times like ‘in the present age.’ This makes their usage as a diagnostic tool a bit suspect. Secondly while Malayalam, unlike Hausa (Mucha 2012, 2013) and Navajo (Smith et. al. 2007), does not allow a recent past/result state interpretation when a present adverb occurs with a perfective marked verb, suggesting that *u/i* is simply a past marker, it is possible that an additional factor is at play here. Specifically, in many languages, present perfectives are hard to obtain. So, perhaps it just particularly difficult to get any present perfective meaning in Malayalam and the present adverb and context tests with *u/i* just reflect this fact.

However, there are reasons beyond the adverb and context tests to believe that *u/i* is simply a past tense and not a perfect or perfective marker. One reason has to do with the Universal Perfect. There are multiple ways that one can express a Universal Perfect in Malayalam, two of which are given in (26) and (27). In (26) there is an *i* that appears after the verbal root. This *i* is traditionally assumed to be the marker of the Conjunctive/Adverbial participle (see chapter 4 for more information). However, Amritavalli & Jayaseelan try to argue that all *u/i* markers are perfective or perfect. If this were a perfective marker, it would be expected to destroy the homogeneity needed for a Universal perfect reading. One might try to counter this by saying that the imperfective marker that follows it can override the perfective semantics.

However, such an analysis could not be offered for the data in (27). Here there is no imperfective marking following the *u*. Such an analysis in general creates problems, as the second past imperfective form of ‘write’ is *ezhuth-uka(y)-aayirunn-u*. This form could be used to explain to someone why you missed a call ‘I was writing a paper.’ If *u/i* is a perfective marker, then it is not clear how this form would get its imperfective meaning.

(26) njaan ponn-appol, avan moonnu manikkooor-aayi paper
 I leave.PAST-when he three hours-adv paper
 ezhuth-i-kkond-irikk-uka(y)-aayirunnu
 write-PART-LAM-AUX-IMPFV2-be.PAST
 ‘When I left, he had been writing the paper for 3 hours.’

(27) njaan ponn-appol, avan moonnu manikkooor-aayi paper
 I leave.PAST-when he three hours-adv paper
 ezhuth-uka(y)-aayirunnu
 write-IMPFV2-be.PAST
 ‘When I left, he had been writing the paper for 3 hours.’

If *-u/i* were exclusively a morpheme with perfect semantics, then it would seem that Malayalam has no way to express a simple past perfective. These interpretations, as we have seen in this section, are available, however. Additionally, if this *u/i* were really a perfect marker and we assume the Mirror Principle of Baker (1985) and the ordering of functional projections outlined in chapter two, it is not in the expected location in (26). Here it is below both aspect and tense marking instead of being above the aspect morphology but below the tense morphology. These tests lend further support to *-u/i* being simply a past tense morpheme. The next section will present another piece of evidence from the distribution of auxiliaries arguing against the past tense marker being reanalyzed as a perfect or perfective marker. It also provides the beginnings of a formal analysis for tense and aspect in Malayalam.

3.3 The beginnings of a tensed account

The previous section argued that Malayalam is not a tenseless language, specifically that it has both a past tense morpheme, *-u/i*, and a null present tense morpheme. This section provides a broad overview of what a tensed account for Malayalam might look like. It proposes that Malayalam has a TP with tense features, which spell out as tense morphemes when nothing intervenes between the verb and T, and as auxiliaries when another active head intervenes (a la Bjorkman 2011, under review). This account explains the distribution of auxiliaries and the obligatory nature of copulas in Malayalam. Having a TP would make Malayalam a tensed language for those in the ‘no TP’ camp.

This section will use the account for the distribution of auxiliaries cross-linguistically in Bjorkman (2011, under review) to argue that Malayalam lacks a [PERFV] feature and that the *u/i* is simply a past tense marker, thus further supporting the conclusions drawn in the previous section. It also provides the beginnings of a more formal account for the tense and aspect system in Malayalam. As such, this section begins with an overview of Bjorkmans account.

The central idea here goes back to the question discussed at the beginning of chapter 2: if inflectional information is introduced in a separate syntactic position from the verb, how does it unite with the verb? There we said that local Agreement is responsible for uniting the verb and inflectional material. However, sometimes features may appear in a location where it is not possible to have local Agreement. The basic idea then in Bjorkman’s work is that auxiliaries occur to rescue these features that become ‘stranded,’ i.e. have no local head to Agree with.

Bjorkman frames her account using a Distributed Morphology (DM) framework (Halle and Marantz (1993), Halle and Marantz (1994), et seq.). The post-syntactic component of this framework allows for inflectional features to be introduced separately from the verb (in places like T, Perf, Asp) and so during the derivation it is possible for these inflectional features to get ‘stranded’ (i.e. not be united with the verb).

Looking at a diverse set of languages, including English, Basque, Finnish, Kinande (Bantu), Latin, French, Romanian, and Arabic, Bjorkman notices two basic patterns in the distribution of auxiliaries cross-linguistically. The first is the additive pattern found in the passive voice (*was eaten, is eaten*) and progressive aspect (*was eating, is eating*) in English, the imperfective and perfective aspects in Basque, and the Finnish perfect. In these cases, an auxiliary occurs with every instance of the verb. The second pattern is the overflow pattern found in interactions between tense and aspect in Kinande, the perfect and the passive in Latin and past tense and imperfective aspect in Arabic. In this pattern, an auxiliary does not occur uniformly in a given paradigm, but only in certain combinations. The Arabic data in (28) provides an example. In Arabic auxiliaries only appear with the past imperfective, (28-c) but not with the present imperfective, (24b), or the simple past form, (24a). In other words, neither the past nor the imperfective alone triggers the presence of an auxiliary. It is only the combination that results in the presence of an auxiliary.

- (28) a. darasa
 study.PAST.PERFV.3SGM
 ‘He studied.’
- b. ya-drusu
 3M-IMPFV.study
 ‘He studies.’
- c. Kaana ya-drusu
 Be.PAST.3SGM 3M-IMPFV.study
 ‘He was studying/He used to study.’ (Benmamoun (2000), p. 27-29)

Bjorkman accounts for the cross-linguistic range of patterns in the distribution of auxiliaries by making use of the idea that languages can vary with respect to what features they have that are involved in encoding the syntax of inflectional categories. She begins with the observation that a language does not have to have both [Past] and [Present] features or both [Imperfective] and [Perfective] features in the syntax. Rather, it could simply have just a [PAST] feature or just a [PRES] feature appearing at T and/or just an [IMPFV] feature or a [PERFV] feature appearing at Asp, with the opposite feature being contrastively underspecified. In her system, auxiliary verbs

appear when a feature cannot be united with a verb (i.e. is stranded) because another feature is intervening.

Turning back to Arabic, Bjorkman argues that the pattern in (28) occurs because Arabic has only a [PAST] feature appearing at T and only an [IMPFV] feature appearing at Asp. As a result, no auxiliary is needed in the present imperfective or the past perfective because the verb can unite with the [IMPFV] feature in the case of the present imperfective and with the [PAST] feature in the case of the past perfective. This is schematized in (29)-(30).

- (29) darasa (Past (Perfective))
 study.PAST.PFV.3SGM

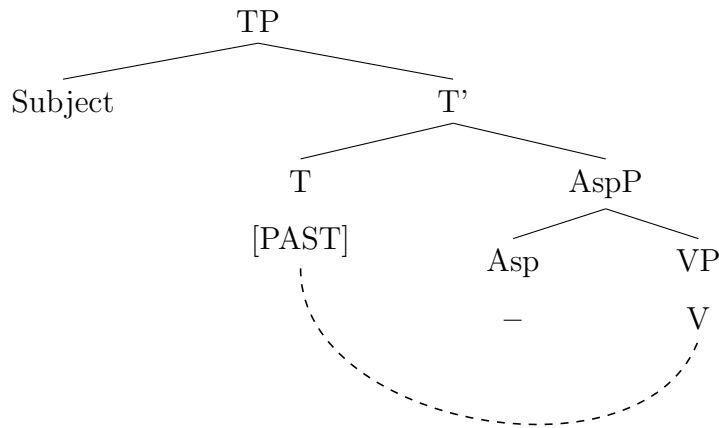

- (30) ya-drusu
3M-IMPF.study

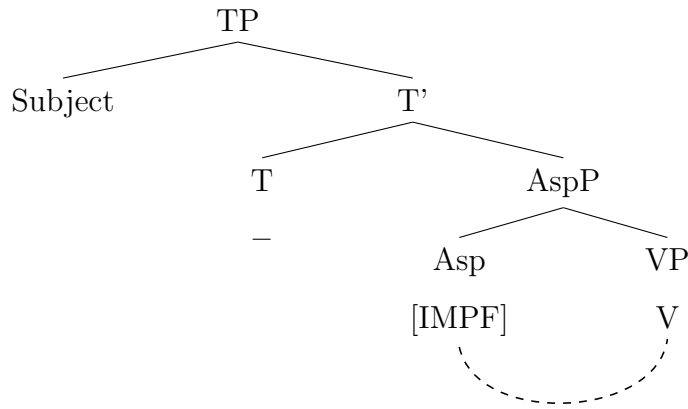

(Bjorkman under review, p20: 13)

However, an auxiliary is needed in the past imperfective because the [PAST] feature at T is stranded due to the intervening [IMPFV] feature at Asp. This is schematized in (31).

- (31) kaana ya-drusu
be.PAST.3SGM 3M-IMPF.study

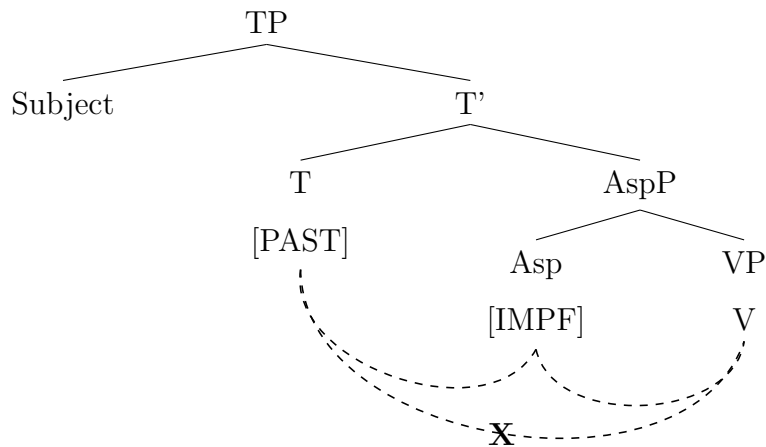

(Bjorkman under review p21: 14)

As further evidence for this position, Bjorkman notes that the copula is absent in Arabic in the present but mandatory in the past and future. These facts follow

if there is no [PRES]-feature in the syntax in Arabic. She also provides independent evidence that Arabic has only an [IMPFV] feature due to the fact that perfective marking can be used in sentences that do not have perfective interpretations.

In English the progressive form uniformly contains an auxiliary in all tenses and the perfective uniformly lacks an auxiliary in all tenses. This, Bjorkman argues, is because English has both [PRES] and [PAST] tense features and only a [PROG] aspect feature, as illustrated in 3.5.

English	Tense/aspect combination	features
is walking	present progressive	[PRES][PROG]
was walking	pas progressive	[PAST][PROG]
walked	past ‘perfective’	[PAST]

Table 3.5: Features associated with English tense/aspect auxiliaries

English equative sentences, unlike Arabic, also require a copula irrespective of the tense. This is compatible with the features Bjorkman proposes for English.

Turning now to Malayalam, recall that this chapter has so far argued for the meanings given in (32-a)-(32-c). The next section will further discuss the meaning of the morpheme in (32-e) and (32-d) follows the general consensus in the literature.

- (32)
- a. *unnu*: imperfective
 - b. *:* present
 - c. *u/i*: past
 - d. *um*: future/modal
 - e. *uka*: imperfective

Recall from table 3.6, repeated below, that in all instances of imperfective 2 and in the past and future of imperfective 1, a copula is required to express tense.

-	Imperfective 1	‘Imperfective 2’	Perfective
Present	var- unnu (<i>undu</i>)	var-uka(y) <i>aanu</i>	—
Past	var- unnu <i>undaayirunnu</i>	var-uka(y) <i>aayirunnu</i>	vann-u
Future	var- unnu <i>undaayirikkum/undaakum</i>	var-uka(y) <i>aayirikkum</i>	chirikk-um

Table 3.6: Tense/aspect paradigm for *var-* ‘come’

In the present form of imperfective 1, the presence of the copula gives *verum focus*. The previous section argued that Malayalam has a null present tense marker, when the copula is not present, based on the fact that *unnu* without an auxiliary can only be used with present adverbs and present contexts. No auxiliaries are present in the perfective forms. Using Bjorkman’s proposal, this pattern suggests that Malayalam has a [PRES] feature in the syntax, which corresponds to either the null present morpheme or an overt auxiliary, the copula *undu*, as well as a [PAST] feature that corresponds to the past tense morpheme *u/i*. Such a position is supported by the fact that Malayalam, unlike Arabic, does not generally allow null copulas in present sentences (or past sentences), (33).

- (33) a. *njaan doctor aanu*
 I doctor be.PRES
 ‘I am a doctor.’
- b. *njaan doctor aayirunn-u*
 I doctor be-PAST
 ‘I was a doctor.’
- c. **njaan doctor*
 I doctor
 ‘I am/was a doctor.’

We also can assume that, like Arabic, Malayalam has just an [IMPFV] feature since there does not appear to be a dedicated perfective marker for main verbs in Malayalam, and as we saw from the universal perfect data in the previous section, the past tense marker *u/i* does not double as a perfective marker. Malayalam could, in principle, just have a null perfective marker for main verbs. However, given Bjorkman’s system, the distribution of auxiliaries in Malayalam suggests that this is not the case. If Malayalam did have a [PERFV] feature, null or otherwise, this feature would be expected to intervene between the verb and T causing the tense feature in the perfective to become stranded. This would then trigger the insertion of an auxiliary. However, no auxiliary appears in the perfective in Malayalam. As such, we could posit the Vocabulary Insertion Entries in (34) for Malayalam.¹⁶

¹⁶I follow Bjorkman in assuming a Distributed Morphology framework here, though nothing in

Vocabulary Insertion Rules (Version 1)

- (34) a. - ↔ [PRES]
 b. -um ↔ [FUT/MOD]
 c. u/i ↔ [PAST]
 d. -unnu ↔ [IMPFV]
 e. uka ↔ [IMPFV]

In Table 3.7 we see that in all the tense and aspect combinations where there are two features ([IMPFV] +[PRES], [PAST] or [(FUT)MOD]) an auxiliary is present. This is because when the [IMPFV] feature intervenes between the verb and a higher head like T, the feature at T becomes stranded and an auxiliary is needed. However, none of the perfective verbs have auxiliaries suggesting that there is only one feature here, that of tense.

-	Imperfective 1	‘Imperfective 2’	Perfective
Present -	var- unnu (<i>undu</i>) [PRES][IMPFV]	var-uka(y) <i>aanu</i> [PRES][IMPFV]	— -
Past -	var- unnu <i>undaayirunnu</i> [PAST][IMPFV]	var-uka(y) <i>aayirunnu</i> [PAST] [IMPFV]	vann-u [PAST]
Future -	var- unnu <i>undaayirikkum/undaakum</i> [FUT/MOD][IMPFV]	var-uka(y) <i>aayirikkum</i> [FUT/MOD][IMPFV]	chirikk-um [FUT/MOD]

Table 3.7: Features associated with Malayalam tense/aspect auxiliaries (Version 1)

Given that Malayalam lacks a perfective feature, there is a question of how to obtain perfective semantics. Here there seem to be two options. The first is that there is an AspP in the syntax. It just has no features. Such an Asp is interpreted as the unmarked feature. In the case of Malayalam and English, that would be the perfective feature since both languages have other dedicated imperfective/progressive morphology. The second option is that there is no AspP in the syntax when there is no feature on Asp. In this case the semantics of verbs would be enriched with viewpoint aspectual properties in the perfective but not in the imperfective. Moving forward I what follows crucially relies on this framework. The difference between (d) and (e) will be explored in the next section and the VI rules revised accordingly. The form in (e) will be argued to be a progressive marker.

will choose to assume the first option, but the second one could also conceivably be worked out. When a tense or aspect feature is present at Asp or T, this feature will be used by the interpretative component to spell out the semantics corresponding to the feature valuation, as explained in chapter 2. How exactly the intricacies of tense semantics work in Malayalam, for example whether a quantificational or pronominal approach to tense is best, is something I will leave for future research. But the auxiliary and copula data fit with the data from the previous section to argue that Malayalam does have morphology that encodes tense in a Klein (1994) sense.

3.3.1 Interim summary

Before moving on, let us take stock of the conclusion in this chapter so far. Section one highlighted the complexity of the tense-aspect puzzle in Malayalam. Section two compared Malayalam to other languages argued in the literature to be tenseless and showed that Malayalam is empirically different from these languages. Malayalam does have morphology that encodes tense semantics, making it a tensed language for those in the ‘no overt morphology’ camp. This section provides a sketch of an analysis for tense and aspect in Malayalam. The previous subsection argued that Malayalam has a TP with tense features, which spell out as tense morphemes when nothing intervenes between the verb and T, and as auxiliaries when another active head intervenes. The evidence offered here came from the distribution of auxiliaries and the obligatory nature of copulas in Malayalam. Having a TP makes Malayalam a tensed language for those in the ‘no TP’ camp.

3.4 The difference between the two ‘imperfectives’

Two questions arise at this point. First, what is the difference between the two imperfectives? On any account we expect there to be a competition between the two imperfectives. However, we have said nothing that hints as to what this competition might be. The second concerns the fact that imperfective 1 and 2 spell out the stranded tense feature using different copulas. The second half of this section explores

the behavior of these two copulas in Malayalam more closely. It will not ultimately provide a formal account for why the two imperfectives use different copulas, but it will present a more careful study of the subtle meanings of these two copulas than has previously been done. This information will lay the foundation for a formal account.

I begin this section by teasing apart the meaning of the two imperfectives. A seemingly straightforward solution is simply to say that imperfective 2 is a progressive marker due to the fact that it only has an event-in-progress reading, (35). Imperfective 1, on the other hand, looks like an imperfective marker in that it can have both an event-in-progress reading and a characterizing reading, (36). As such, an updated version of the Vocabulary Insertion rules might be those in (37).

(35) *njaan chirikk-uka(y) aanu*
 I laugh-PROG be.PRES
 ‘I am laughing (now).’ #‘I laugh (in general).’

(36) *njaan chirikk-unnu-∅*
 I laugh-IMPFV-PRES
 ‘I am laughing (now)’ or ‘I laugh (in general).’

Vocabulary Insertion Rules (Version 2)

- (37) a. $-\emptyset \leftrightarrow [\text{PRES}]$
 b. $-um \leftrightarrow [\text{FUT}/\text{MOD}]$
 c. $u/i \leftrightarrow [\text{PAST}]$
 d. $-unnu \leftrightarrow [\text{IMPFV}]$
 e. $uka \leftrightarrow [\text{PROG}]$

However, the rest of the section will argue that such a straightforward distinction is not possible. The gist of the argument will be that while *uka* ‘imperfective 1/progressive’ looks more or less compatible with an intensional progressive meaning like the one outlined in chapter 1, *-unnu* ‘imperfective 2’ differs in a number of ways from imperfective markers, in say Italian or Hindi, one of which is that it is not an intensional operator.

Returning back to the VI rules in (37), since *uka* and *unnu* can both have event-in-progress (progressive) uses, one might ask if there are any subtle meaning shifts that result from choosing one form over the other in a given progressive context.

Earlier in the chapter it was noted that, unlike the progressive in English and Malayalam, the *unnu* imperfective cannot be used in a futurate sentence, i.e. in a sentence expressing a plan about the future that lacks any future marking, (38).

Context: An optimist claims emphatically that tomorrow he will win, despite having failed in previous attempts.

- (38) naale njaan {jayikk-uka(y)-aanu, *jayikk-unnu- \emptyset }.
 tomorrow I win-PROG-be.PRES win-IMPFV-PRES
 ‘Tomorrow I am going to win.’

Copley (2008) argues that futurates involve modal semantics. The ability of the *uka* progressive marker to appear in a futurate context, just like the English progressive, fits with the idea introduced in chapter one via the imperfective paradox, that progressives often contain a modal meaning. However, the inability of *unnu* to occur in futurates would be compatible with an account where *unnu* is simply an existential operator.

Another, perhaps related, difference is that in English a progressive sentence like (39) can be used to describe either of the following two scenarios:

- (39) He was writing his autobiography when he died.

Scenario 1: He is sitting at his desk, pen in hand/keyboard in front of him, writing his autobiography, when he suddenly has a heart attack and dies instantly.

Scenario 2: He dies in his sleep. One of the many projects he happened to have going on around the time of his death was the writing of his autobiography. [He was not actually engaged in the act of writing at the moment when he died.]

In Malayalam, on the other hand, the facts are different. The progressive marked sentence in (39a) can be used to describe scenario 1, but the sentence using *unnu* in (40-b) cannot be used here. It can only be used to describe scenario 2. Speakers

suggest that the happenstance factor is particularly important in licensing (40-b).

- (40) a. avan marikk-um-bol avan avan-te aathmakadha
 he die-UM-when he he-GEN autobiography
 ezhuth-uka(y)-aayirunnu
 write-PROG-be.PAST
 ‘He was writing his autobiography when he died.’ [ok Scenario 1, X
 Scenario 2]
- b. avan marikk-um-bol avan avan-te aathmakadha
 he die-UM-when he he-GEN autobiography
 ezhuth-unn-undaayirunnu
 write-IMPFV-be.PAST
 ‘He was writing his autobiography when he died.’ [ok Scenario 2, X
 Scenario 1]

Another place where a subtle meaning difference exists is in (41). When the progressive is used, as in (40a), the sentence has the meaning that I was laughing constantly throughout the movie (because it was so funny). However, when *-unnu* is used, the meaning is that, during the time the speaker watched the movie, they laughed a number of times, perhaps whenever a particular line was said or a particular character appeared. Speakers comment that the ‘action’ described by verbs with *unnu* feels ‘bounded’ or ‘contained’ and it is viewed as a single event, even though it contains multiple episodes of a given event.

- (41) a. njaan sinimu kand-aapol njaan chirikk-uka(y)-aayirunnu
 I movie see.PAST-when I laugh-PROG-be.PAST
 ‘When I saw [watched] the movie, I was laughing.’ [laughing throughout
 the movie]
- b. njaan sinimu kand-aapol njaan chirikk-unnu-undaayirunnu
 I movie see.PAST-when I laugh-IMPFV-be.PAST
 ‘When I saw [watched] the movie, I was laughing.’ [laughing at multiple
 points throughout the movie]

These intuitions that the progressive use of *unnu* is episodic in nature, has a ‘happenstance’ feel, and cannot be used in futurates aligns with Hany Babu’s (2006) intuitions

about the so-called ‘generic/characterizing’ use of *unnu*. Specifically, he will argue that it is extensional and episodic.

There are two ways in Malayalam to give what appear to be characterizing readings: *-unnu*, (42), and *-um*, (41a). The *um* in Malayalam has a number of uses, beyond characterizing readings. One of these is as the future marker; see Hany Babu (2006) for overview of other uses. The general consensus in the Malayalam literature is that *um* is a modal (John (1987), Hany Babu (1997), Amrtiavalli & Jayaseelan 2005, et. seq., a.o.).¹⁷

- (42) njaan chirikk-unnu-∅
 I laugh-IMPFV-PRES
 ‘I am laughing (now)’ or ‘I laugh (in general)’
- (43) a. njaan chirikk-um
 I laugh-MOD
 ‘I laugh (in general)’ #‘I am laughing (now).’ or ‘I will laugh’ [certain]
- b. njaan chirikk-aam
 I laugh-MOD
 ‘I may laugh.’

The sentences in (44) show one way that generic uses of *unnu* differ from generic uses of *um*: *unnu* can be used to describe accidental generalizations, while *um* cannot be.

¹⁷Often times the modal *aam* is more commonly used in places where an English future would be used because it conveys less certainty than *um* does. For example, if you tell someone (i), they will most likely respond *paray-aam* not *paray-um* to mean ‘I will tell (them)’ even when they fully intend to pass on your well wishes to their family. Speakers comment that this is because life is uncertain; something might happen that would prevent them from telling their family, despite their best intentions.

- (i) Veed-il ull-a ellarodum ente anweshanam paray-anam
 house-LOC be-REL all I.GEN regards tell-DEB
 ‘Say/tell my regards to your family.’

Another example of the same type can be found when saying goodbye to a friend. To express the equivalent of the English sentence ‘I will see you tomorrow’ when saying goodnight to a friend people generally say: *naale kaan-aam* not *naale kaan-um*, even when both participants fully plan to see each other the next day. Again speakers comment that this is due to the uncertainty of life. An *-um* marked form would be appropriate in the context of a very serious matter, say when affirming to a teacher that the speaker will be present for the next days exam. This thesis will not explore the shades of certainty encoded in *um* as compared to other modals like *aam*.

- (44) a. Chennai-yil daivangal thingi-ppaarkk-unnu- \emptyset
 Chennai-LOC gods dense-dwell-IMPFV-PRES
 ‘Gods dwell densely in Chennai, i.e. Chennai happens to have a lot of
 temples.’
- b. ??Chennai-yil daivangal thingi-ppaarkk-um
 Chennai-LOC gods dense-dwell-MOD
 ‘Gods dwell densely in Chennai, i.e. the essential property of Chennai is
 that it has a lot of temples.’ (ok as a prediction: ‘Chennai will have a
 lot of temples.’) (Hany Babu 2006 p10: 11 from Jayamohan 2001)

One of the properties of generics, according to Krifka et al. (1995) is that they cannot be used for accidental generalizations. The data in (44) suggest that while *um* fits Krifka et. al.s definition of a generic, *-unnu* does not. Hany Babu (2006) further points out that *unnu* has an episodic property. This is also not expected with a generic (Carlson (2005)).

Hany Babu, as well as some other speakers consulted, find (45) very odd because it suggests that Usha has been getting up at 6am since the beginning of time. These speakers note that when an adverb like *oru aazhchayaayi* ‘for one week’ that limits the interval containing the events being generalized over is added, (46), it no longer has a strange feel. The parallel sentence with *um*, (45-b), suffers from no such problem.

- (45) a. #usha ennum aaru-manikku ezhuneelkk-unnu- \emptyset
 Usha daily 6-oclock get.up-IMPFV-PRES
 ‘Usha gets up daily at six oclock.’
- b. usha ennum aaru-manikku ezhuneelkk-um
 Usha daily 6-oclock get.up-MOD
 ‘Usha gets up daily at six oclock.’ (Hany Babu 2006 p11: 12)
- (46) oru aazhchay-aayi usha ennum aaru-manikku ezhuneelkk-unnu- \emptyset
 one week-become Usha daily 6-oclock get.up-IMPFV-PRES
 ‘For the last one week, Usha has been getting up at six oclock.’ (Hany Babu
 2006 p11: 13)

Some speakers I have consulted do not find (44a) or the sentences in (47) odd. I suspect this is because these speakers simply accommodate a more restricted timespan.

- (47) a. *usha ennum pazhum kazhikk-unnu-∅*
 Usha daily banana take-IMPV-FV-PRES
 ‘Usha daily eats bananas.’
- b. *usha ennum ambala-thil pook-unnu-∅*
 Usha daily temple-LOC go-IMPV-FV-PRES
 ‘Usha daily goes to the temple.’
- c. *usha kochi-yil thamasikk-unnu-∅*
 Usha Kochi-LOC live-IMPV-FV-PRES
 ‘Usha lives in Kochi.’

In light of the fact that *unnu* can describe accidental generalizations, Hany Babu (2006) suggests that *unnu* is not an intensional operator but an extensional one.¹⁸ In what follows, the thesis will continue to call this reading the ‘generic’ for ease of reference even though it argues that *unnu* does not license a true generic reading. The *um* characterizing reading, on the other hand, does not allow accidental generalizations, suggesting that an intensional analysis for it is on the right track. Due to the episodic nature of *unnu*, also unexpected for generics as defined in Krifka et. al., Hany Babu (2006) proposes that the primary function of *unnu* is to license a situation variable which will then either be bound by an existential copula, in the case of event-in-progress readings, and an extensional GEN operator or adverb of existential closure, as in (46), in the case of ‘generic’ readings. He does not further spell out what the semantics of this extensional GEN OP would look like.

Whether or not it is correct to accept Hany Babu’s proposal regarding the existential and extensional GEN OPs, Hany Babu’s desire to provide a unified analysis for event-in-progress/progressive and the ‘generic’ uses of *unnu* can be accepted. Progressives uses of *unnu* require a happenstance context and do not license futurates, which is compatible with *unnu* being extensional. It also has the episodic requirement.

The progressive form, *uka*, on the other hand, can be used in futurate contexts and on a true event-in-progress reading (scenario 1 for (40)) in contexts which require access to inertia worlds, which suggests that we might give it the same entry as Beck

¹⁸As such, one would not expect generic *unnu* to be a ‘finiteness’ marker located in MoodP as Hany Babu & Madhavan (2003) propose because if *unnu* is not an intensional operator, it should not be inherently linked to the place where anchoring by mood/modals (of which *um* is one), in other words by worlds, occurs.

& von Stechow (2015) give the English progressive.

$$(48) \quad \lambda w. \lambda t. \lambda P_{\langle s, \langle v, t \rangle \rangle}. \forall w' [w \text{ INERT}_t w' \rightarrow \exists t' [t \text{ is a non-final part of } t' \ \& \ \exists e [\tau(e) \subseteq t' \ \& \ P(w')(e)]]] \text{ (Beck \& von Stechow 2015, cf. Dowty, 1979)}$$

This then would be the semantics corresponding with the [PROG] feature. What then would be the semantics of *unnu*? Hany Babu's claim that progressive/event-in-progress uses come when the situation variable is bound via existential closure, sometimes via the existential copula *undu* only gives the semantics that there exist a series of episodes. However, as Carlson (2005) notes, progressive/event-in-progress readings are distinct from iteratives. Indeed such a meaning is quite different from even the extensional Klein (1994) progressive meaning of Topic Time \subseteq Situation Time.

A key empirical fact motivating Hany Babu's proposal is that when the copula *undu* is absent, an *-unnu* marked sentence can have either the event-in-progress or a 'generic' reading, (48a). However, when *undu* is added, only the event-in-progress reading is possible, (49-b).¹⁹

- (49) a. suuryan kizhakku udhikk-unnu- \emptyset
 sun east rise-IMPFV-PRES
 'The sun rises in the east.' [generalization over a series of episodes of individual risings] or 'The sun is rising in the east.'

¹⁹The two sentences are not totally equal in their information structure properties, even when they both have a progressive/event-in-progress use. Speakers consulted note that the addition of the *undu* copula in present tense sentences gives an emphatic/verum focus reading. For example, if someone tells you *kazhikku* 'eat!' and you respond back *kazhikk-unnu undu*, it has the feel of saying something like 'I AM eating' with the connotation that you do not like the fact that they were telling you to eat. Also, if you are expecting a guest, but he is quite late and then finally he calls your husband, you can ask your husband after the phone call *avan var-unn-oo?* 'Is he coming?' And your husband can reply *avan var-unnu undu* 'he IS coming.' It also can be used in cases where English uses emphatic 'do'-support: if someone asks you, doubtfully, 'Do you love your husband?', you can respond back *njaan bhārathāav-e sneehikk-unnu undu* 'I DO love my husband.' I suspect that the reason that the present of *undu* but not the past triggers this type of inference comes from the fact that *undu* alternates with the null present marker. Perhaps one could make an analogy with the type of information structure properties obtained with an overt subject is used in a null subject language like Spanish (cf. *hablo español* 'I speak Spanish' vs *Yo hablo español* 'I speak Spanish.' These information structure facts are compatible with *undu* introducing an immediacy requirement in certain contexts, as will be suggested below.

- b. suuryan kizhakku udhikk-unn-undu
 sun east rise-IMPFV-be.PRES
 ‘The sun is rising in the east.’#‘The sun rises in the east.’ (Hany Babu
 2006 p)

Hany Babu (2006) suggests that *undu* is the existential copula and thus introduces an existential operator that is in complementary distribution with the generic operator, which is why when *undu* occurs only the event-in progress reading is possible.

In what follows it is suggested that the two separate operators are not needed. Instead in the following sections it will be suggest that *unnu* has a single meaning that is narrower than a generic because it is not intensional and episodic but wider than an iterative because it has the subinterval property, unlike iteratives. This meaning will allow for both the more limited ‘generic’ and ‘event-in-progress’ uses of *unnu*. The inspiration for this alternate account is the same facts in (49) coupled with a more in-depth study of the two copulas in Malayalam. The claim will be that *undu* sometimes carries an ‘immediacy requirement’ like that found by Patel-Grosz (2016) in certain negative imperatives cross-linguistically. Forms with this immediacy requirement cannot be used as general prohibitions. I will suggest that this anti-generality extends to *undu* in Malayalam making the data in (49) unsurprising. This intuition also brings one of the questions that this section began with, namely, why is the auxiliary different in the progressive, *-uka*, form and the imperfective, *unnu*, form?, back into focus.

3.4.1 An intuition about the semantics for *-unnu*

This section sketches an intuition for the semantics of *unnu*. The basic idea is that *unnu* involves the occurrence of an iterative inside of a special interval which also has the subinterval property. The claim is then that *unnu* shares properties with both iteratives and generics but is neither.

Payne (1997) defines an iterative as a ‘punctual event takes place several times in succession’ (p39). Carlson (2005) adds that the episodes of the event are connected with each other in time and often have further implications such as intensity or a

prolonged activity, as in (50-a).

- (50) a. John coughed and coughed.
b. The bird was flapping its wings.

He notes that progressives, while they often imply iteration, as in (50-b), are not iteratives themselves. One way that generics differ from iteratives is that generics do not describe a connected series of events. Generics, like statives, also have the subinterval property, which iteratives lack.

The idea for *-unnu* is that it introduces an interval, *i*, in the actual world (@) which contains multiple episodes of a given event, *e*. This would result in a Klein (1994)-like perfective meaning, $ST \subseteq TT$. However, then a generalization is made that since *i* contains multiple episodes of *e*, all subparts of *i* contain an instance of *e*. This results in the interval having the subinterval property like a generic sentence, and unlike an iterative sentence. However, unlike a generic sentence, it is existential and episodic. Since the interval has the subinterval property, it provides a Klein-like progressive meaning ($TT \subseteq ST$). In (51), repeated from above, the topic time, watching the movie, is equivalent to *i*. This means that multiple events of laughing occurred in *i*, resulting in the generalization that every subpart of *i* contains an instance of laughing.

- (51) njaan sinimu kand-aapol njaan chirikk-unnu undaayirunnu
I movie see.PAST-when I laugh-IMPFV be.PAST
'When I saw [watched] the movie, I was laughing.' [laughing at multiple
points throughout the movie]

This need not be the case. To see this, look at example (52). Here the Topic Time, 'when I slipped on the floor' is very short, probably simply an instant.

- (52) a. njaan veen-aapol avan thumm-unnu undaayirunnu
I slip.PAST-when he sneeze-IMPFV be.PAST
'He was sneezing when I slipped on the floor.' [he happened to be in a
state of sneezing every few seconds (say because he had a cold)]

- b. njaan veen-aapol avan thumm-uka(y)-aayirunnu
 I slip.PAST-when he sneeze-PROG-PAST
 ‘He was sneezing when I slipped on the floor.’ [the moment I slipped, he
 was in the middle of a sneeze]

In (51a) *-unnu* again deals with an interval, *i*, in the actual world which contains multiple episodes of a sneezing event, *e* (Klein-like perfective meaning) and then generalizes that since *i* contains multiple episodes of *e*, that all subparts of *i* contain an instance of *e*. This results in a Klein-like progressive meaning. The difference here is that the time of slipping (the topic time) is contained in *i*, which is an interval all of whose subintervals contain an instance of sneezing. This contrasts in meaning with the purely progressive meaning of the *uka* progressive marked sentence in (52-b).

The same idea explained for (51) and (51a) works for (53), repeated from above. There is an interval, *i*, in the actual world which contains multiple episodes of a writing event, *e* (Klein like perfective meaning). Then a generalization is made that since *i* contains multiple episodes of *e*, all subparts of *i* contain an instance of *e* to give a Klein-like progressive meaning. The dying time (the topic time) is then placed inside of *i*, and every subinterval of *i* contains an instance of writing.

- (53) avan marikk-um-bol avan avan-te aathmakadha
 he die-UM-when he he-GEN autobiography
 ezhuth-unn-undaayirunnu
 write-IMPFV-be.PAST
 ‘He was writing his autobiography when he died.’ [incidentally one of the
 projects he happened to have going at the time of his death (though he
 didn’t have to be writing when he died)]

The ‘generic’ cases from above, repeated here in (54), can likewise be accounted for with this idea. The interval *i* contains multiple events in the actual world of gods dwelling in Chennai (in temples)/the sun rising in the east/Usha getting up at six o'clock. Then a generalization is made that since *i* contains multiple episodes of *e*, all subparts of *i* contain an instance of *e* to give a Klein-like progressive meaning. This generalization, at the same time, can be taken the state of things in the actual world,

resulting in the ‘generic’ use.

- (54) a. Chennai-yil daivangal thingi-ppaarkk-unnu- \emptyset
 Chennai-LOC gods dense-dwell-IMPV-PRES
 ‘Gods dwell densely in Chennai, i.e. Chennai happens to have a lot of
 temples.’
- b. suuryan kizhakku udhikk-unnu- \emptyset
 sun east rise-IMPV-PRES
 ‘The sun rises in the east.’[generalization over a series of episodes of
 individual risings] or ‘The sun is rising in the east.’
- c. oru aazhchay-aayi usha ennum aaru-manikku ezhuneelkk-unnu- \emptyset
 one week-become Usha daily 6-oclock get.up-IMPV-PRES
 ‘For the last one week, Usha has been getting up at six oclock.’ (Hany
 Babu 2006 p11: 13)

From these sentences, we can see that the size of the interval i is determined by one of the three things: non-instantaneous when clauses (i.e. ‘when’ clauses that are equivalent to the Topic Time), (51), adverbs, (54-c), and context, (44a), (47), for those speakers who accept these sentences, and (53a)-(53b), for all speakers.

In the case of a stative verb like *kan-* ‘see’, (55), the predicate already has the subinterval property, so generalizing over the interval i is not necessary. The murder time would then be located inside of i . Stative predicates conform to the episodic requirement via their subevents.

Context question: What were you doing last night at the time of the murder?

- (55) a. innaale rathri njaan sinimu kan-unnu undaayirunnu
 yesterday night I cinema see-IMPV be.PAST
 ‘Last night I was seeing [watching] a movie.’
- b. innaale rathri njaan sinimu kan-uka(y)-aayirunnu
 yesterday night I cinema see-PROG.PAST
 ‘Last night I was seeing [watching] a movie.’

The generalizing leap in the examples with non-stative verbs from simply being a bounded collection of interactions of an event to that bounded interval being viewed as a single event which has a subinterval property, has not been explained here.

The example in (56) perhaps suggests that this is the result of a pragmatic process controlled by world knowledge.

Context question: What were you doing last night at the time of the murder?

- (56) a. *innaale rathri njaan sarigal vang-unnu undaayirunnu
 yesterday night I saris buy-IMPFV be.PAST
 ‘Last night I was buying saris.’
- b. innaale rathri njaan sarigal vang-uka(y)-aayirunnu
 Yesterday night I saris buy-PROG-be.PAST
 ‘Last night I was buying saris.’

Given what we have seen so far, we would expect (55a) to mean that the interval i had many events of sari buying in it and then after generalizing over these events, every subinterval of i has an event of sari buying in it and the murder time is contained within this interval, giving a progressive meaning. In other words, we would expect a situation were the speaker was going from store to store buying different saris during i and then the murder happened at some point during all that sari buying. Perhaps the reason that instantaneous predicates like ‘sneeze’, and ‘laugh’ are acceptable while an instantaneous predicate like ‘buy a sari’ is not is that they can be iterated on a moment-to-moment basis whereas multiple sari buying events take more time, i.e. there is transfer times between shops, browsing times, etc. So world knowledge rules out generalizing that every subinterval of i has an event of sari buying in it. One might then wonder about sentences like (53b)-(54-c) where the predicates cannot be iterated on a moment-to-moment basis. Here we might say that the adverb *ennum* ‘daily’ and the world knowledge that the sun only rises once per day defines ‘subinterval’ as ‘day.’ So, i would be a longer span of time, say one week/month/year, etc. or since the dawn of time, and for every subinterval (=day) in that interval, the property holds.

Some further evidence that this intuition is on the right track comes from the following. Speakers comment that the generalizing occurs when there is a ‘running context’ (i.e. that there is an interval, i), which seems to mean that either there is a context which the speaker can see, or possibly hear (for some speakers), occurring in front of him/her which he/she is commenting on, or that the interlocutors already

have a shared context (due to their shared history as close friends or family members).

When no information about the relationship of the speaker with the addressee or whether or not the speaker saw the relevant situation is given, speakers asked to judge the acceptability of sentences like (57) often comment that it is more natural to use the progressive to answer the question. This is because it is ‘more direct’ (what many speakers call a ‘second person answer’) and ‘less removed’ than the *unnu* form. The *unnu* form is used to give a report to someone else (what many speakers call a ‘third person answer’).

- (57) a. Dileepu innale viid-il vann-appool Vinu endu
 Dileep yesterday house-LOC come.PAST-at.that.time Vinu what
 cheyy-uka(y)-aayirunnu?
 do-PROG-PAST
 ‘What was Vinu doing when Dileep came to his house yesterday?’
- b. Dileepu vann-appool Vinu {kalikk-unn-undaayirunnu,
 Dileep come.PAST-at.that.time Vinu play-IMPFV-be.PAST
 kalikk-uka(y)-aayirunnu}
 play-PROG-be.PAST
 ‘When Dileep came, Vinu was playing.’

An example of this ‘third person answer’ (report to someone else) use is given in (58).

Context: You are sitting observing a group of people (consisting of your own children or strangers) eating and you are giving a running commentary about the situation to someone else (who is not a member of the group eating).

- (58) avan dosa kazhikk-unnu- \emptyset , avan chapati kazhikk-unnu- \emptyset , avan
 he dosa take-IMPFV-PRES he chapatti take-IMPFV-PRES he
 choru kazhikk-unnu- \emptyset ...
 rice take-IMPFV-PRES
 ‘He is eating dosa; he is eating chapatti; he is eating rice’

The *uka* progressive does not require the additional interval *i*, which has extra contextual requirements regarding visual (or possibly auditory) evidence/shared context, or have the extra generalizing step present in the *unnu* form. As a result, it may seem more ‘direct’ since it does not require these extra mechanisms.

Speakers comment that the use of *unnu* marked forms can seem theatrical to use if the speaker cannot see the addressee. For example, if someone calls you on the phone and asks you ‘what you are doing?’, it is odd to respond ‘I am eating’ using the *-unnu* marked form, *kazhikk-unnu-∅*, because the other person cannot see what you are doing. Instead, the progressive form, *kazhikk-uka(y)-aanu*, should be used in this context.

The theatrical feeling here comes because, when presented with this context question out of the blue (i.e. when the context question and its answer are not embedded within a larger conversation) and with abstract participants (i.e. the person being asked to provide the judgment in this context does not know anything about who the interlocutors are or their relationship to each other), ‘there is no context running,’ as one speaker comments. Using the *unnu* marked form here feels theatrical because it assumes that such a context exists, yet none does here. As a result, the only way to accommodate the utterance is to assume that speaker is trying to create a ‘running context’ by using the *-unnu* form and this feels theatrical.

Some speakers have commented that when shouting ‘I’m going’ from the doorstep to someone else in the house who could not see the speaker (perhaps because they were in a different room), that they would not use the *unnu* form, *pook-unnu-∅*, in this context. Instead, they would use the progressive form, *pook-uka(y)-aanu*. Other speakers, though, said that use of the *unnu* form in that context is perfectly acceptable. Perhaps this variation can be accounted for based on what counts as a ‘running context’ for different speakers. Those speakers who accept the *unnu* form in this context may be assuming that since both interlocutors are in the same house they will have both be aware of other parts of the context leading up to leaving such as the door opening, the car starting, etc. that would help them create that ‘running context.’

Despite the role that visual evidence seems to play in licensing a ‘running context’ there are contexts where it is fully acceptable (and very common) to use *unnu* marked forms when speaking with someone on the phone (i.e. when the speaker cannot see the addressee). Whether or not is possible to use the *unnu* form on the phone as

an answer the the question ‘what are you doing?’ depends on the relationship of the interlocutors and the nature of the conversation.²⁰ If they do not know each other (say, a sales person or bureaucrat) or have a strictly formal relationship (say, or business colleagues that do not know each other well) then *unnu* marked forms would never be used; only progressive marked forms would be used to express progressive meanings. If the interlocutors have a close relationship (say, a mother and child or two friends), then *unnu* forms may be used. In this case, it depends on the nature of the conversation. If it is a casual conversation then *unnu* marked forms can be used. If it is a serious conversation, they will not be used. The following two examples provide illustrations of examples when the interlocutors are close but are having a serious conversation and, as such, should not use *unnu*.

Context: Your close friend is the editor of a journal. She sends you an email in her official capacity reminding you that your review is due soon. You want to write back, thank her for the reminder, and tell her that you are writing the review.

Here the appropriate form to use would be the progressive one, *ezhuth-uka(y)-aanu*, not the *unnu* form, *ezhuth-unnu-∅* because the *unnu* form would be too casual in this context. If she sent you an email simply as your friend about something else you were writing, it would be natural to answer with the *unnu* form.

An additional context further illustrates this point.

Context: Your mother calls you to discuss about a serious matter (such as a family problem or a serious illness). For example, maybe your cousin has just been diagnosed with cancer. After giving the initial information, your mother might ask, ‘What are you doing now? I need to tell you more about his condition.’

In this context, if you are eating, the appropriate form to use is the progressive, *kazhikk-uka(y)-aanu*. If the *unnu* form, *ezhuth-unnu-∅*, is used, it is very disrespectful because it conveys that you do not care about the fact that your cousin has cancer and you just want to be left alone because the situation is a normal one for you. However, if the question comes in the context of your nightly call with your mom,

²⁰If the person is in the same room as the speaker, it is perfectly natural to say ‘I am eating’ using either form, *kazhikk-unnu-∅* or *kazhikk-uka(y)-aanu*.

where both of you have had ordinary days and you both are reasonably happy, it is perfectly acceptable to use the *unnu* form, *ezhuth-unnu-Ø*, to answer her question.

Many speakers comment that a progressive, *-uka(y)-aanu*, form is more respectful than an *unnu* form. Probably this is because the use of the progressive assumes no prior context and assuming a prior context where there is not one is rude. There is a parallel with this in the pronominal system in Malayalam. For example, there are several 2nd person pronouns in Malayalam. One of these pronouns, *nii*, is only used to address close friends. Using this pronoun to call someone you do not know would be rude because it assumes a shared, positive context exists between the interlocutors. An unknown person would feel annoyed that someone they did not know was calling them in such a familiar way. See Swenson & Marty (under revision) for further details about how the distance between interlocutors plays an important role in the Malayalam pronominal system.

While providing some suggestive facts about how the interval *i* (the ‘running context’) is created, there are many open questions for further research. A point to consider before moving on though, is that, however, the interval *i* is created and the semantics of the *unnu* form are formalized, concrete factors like visual and auditory (for some speakers) evidence or a shared history seem to play an important role. This fits with the existential nature of *unnu* that has been argued for in this chapter. The intuitions expressed in this section have, hopefully, helped further expose the complexity of the puzzle and will provide a possible direct for future work on the semantics of *-unnu*. Hany Babu & Madhavan (2003) point out a number of other differences between progressive marked sentences and those marked with *unnu undu* for which the present account has no explanation. These data points are included in appendix A.

3.4.2 Interim summary

This subsection so far has argued that Malayalam *uka* is an intensional progressive marker. On the other hand *unnu* is used when a situation involves multiple, temporally connected episodes taking place within close succession, like an iterative. But

it differs from an iterative in that it cares that these iterations take place within another interval, *i*, in the actual world. Because this interval has or gets the subinterval property, it results in accidental generalizations over these episodes. Because the Topic Time is contained in the Situation Time, this gives a Klein (1994) progressive meaning while the ‘generalizing’ step that gives the progressive meaning also results in a report on the state of things in the actual world, i.e. the ‘generic’ use of *unnu*. This results in it having the appearance of an imperfective. A summary of all of the parts and features argued for thus far is given in the Table in 3.8.

-	Imperfective 1	Progressive	Perfective
Present -	var- unnu (<i>undu</i>) [PRES][‘IMPFV’]	var-uka(y) <i>aanu</i> [PRES][PROG]	— -
Past -	var- unnu <i>undaayirunnu</i> [PAST][‘IMPFV’]	var-uka(y) <i>aayirunnu</i> [PAST] [PROG]	vann-u [PAST]
Future -	var- unnu <i>undaayirikkum/undaakum</i> [FUT/MOD][‘IMPFV’]	var-uka(y) <i>aayirikkum</i> [FUT/MOD][PROG]	chirikk-um [FUT/MOD]

Table 3.8: Features associated with Malayalam tense/aspect auxiliaries (Version 2)

One question still to be answered is why the presence of the *undu* copula as in (59-b) rules out the progressive/event-in-progress reading. Hany Babu (2006) tries to account for these facts by saying that two different types of quantifiers are used to obtain the event-in-progress verses the ‘generic’ use and that *undu*, the existential copula, is the overt representation of the existential operator used in the progressive cases. The previous subsection argued against such a proposal above and suggested that the facts in (59) can be accounted for via an independent requirement the *undu* copula sometimes carries.

- (59) a. suuryan kizhakku udhikk-unnu- \emptyset
sun east rise-IMPFV-PRES
‘The sun rises in the east.’ [generalization over a series of episodes of individual risings] or ‘The sun is rising in the east.’
- b. suuryan kizhakku udhikk-unn-undu
sun east rise-IMPFV-be.PRES
‘The sun is rising in the east.’ #‘The sun rises in the east.’ (Hany Babu 2006 p)

The next section will provide a more in depth exploration of the two copulas in Malayalam to lead us closer to a formulation of this independent requirement.

3.5 *Undu* vs *aanu*: The different ‘being’ verbs in Malayalam

In this section the use of the two copulas will be examined. Like Spanish, Malayalam has two different copulas: *undu* and *aanu*. Just as in Spanish, the general notions like ‘temporary’ versus ‘permanent’ seem to play a role in determining which copula is used. Based on this, a first hypothesis might be that the account for *ser* and *estar* can be extended to Malayalam. Menon (2008), Menon (2016) argues against such an extension, and while this chapter presents a slightly different set of facts than Menon does, it ultimately agrees with her conclusion that the Malayalam copulas differ from *ser* and *estar*.

In order to test the hypothesis that the Malayalam copulas are like the Spanish ones, one must answer the following two questions: first, what is the account for *ser* and *estar* in Spanish and secondly, does the Malayalam data match the Spanish data? In fact, the first question is a bit simplistic, as finding a single, unified account that can explain the distribution of *ser* and *estar* has proven difficult. Since the remainder of this chapter will argue against a Spanish-style account based on empirical differences between Spanish and Malayalam, an in-depth overview of the literature on *ser* and *estar* will not be given. See Camacho (2012), Camacho (2015) for a summary of the different accounts and references.

Rather, the rest of this chapter will highlight the empirical differences between Spanish and Malayalam and then suggest that something along the lines of ‘immediacy’, i.e. how relevant the situation being discussed is to the present moment, is a better direction to pursue for Malayalam. Cross-linguistic evidence from East Austrian German, Norwegian, Kutchi Gujarati and English show that immediacy is encoded in the grammar in these languages as well, not necessarily in copula selec-

tion, but in the way negative prohibition is expressed Patel-Grosz (2016). The first part of this section examines the more straightforward use of copulas in Malayalam and Spanish in equative, predicative, existential and possessive contexts. The second part of the section examines location, medical condition, and psychological predicates, where the facts are more subtle to detect in Malayalam and the important differences between Spanish and Malayalam become clear. The third section provides further details regarding the immediacy requirement and what an account based on this might look like for Malayalam.

3.5.1 Equative, predicative, existential and possessive contexts

In the Malayalam literature, it is common to see *undu* referred to as the existential copula and *aanu* referred to as the equative copula (Mohanan and Mohanan (1999), Menon 2008, 2016 a.o.). The so called ‘equative’ copula *aanu* gets its common name from examples like (60-a), where it equates two referring individuals. It is also used in predicative constructions where it is used for both states, (60-c), and events, (60-b). The other place that only *aanu* is used is in clefts, (56).

- (60) a. *asha raman-te chechi aanu/*undu*
 Asha Raman-GEN older.sister be.PRES
 ‘Asha is Raman’s older sister.’
- b. *malsaram aaru mani-kku aanu/*undu*
 match six time-DAT be.PRES
 ‘The match is at 6 o'clock.’
- c. *avan sundar-an aanu/*undu*
 he beauty-MASC be.PRES
 ‘He is beautiful.’ (Menon 2008 p19: 13-14)
- (61) *vinu aanu/*undu deepa-yude sahodari-ye snehikkunn-athu*
 Vinu be.PRES Deepa-GEN sister-ACC love-NOMLZ
 ‘It is Vinu who loves Deepa’s sister.’

In possessive and existential contexts, Malayalam only allows the copula *undu*. Exam-

ple (62) provides instances of both permanent, (62-a), and temporary, (62-b)-(60-c), existential uses of *undu*.

- (62) a. deivam undu/*aanu
 God be.PRES
 ‘God exists.’ (Mohanana & Mohanana 1999: 19)
- b. meesha meel puthakam undu/*aanu
 table on book be.PRES
 ‘There is a book on the table.’ (Asher & Kumari 1997 p100: 479)
- c. adukkala-thil pampu undu/*aanu
 kitchen-LOC snake be.PRES
 ‘There is a snake in the kitchen.’

Another area where only *undu* is used is in possessive constructions. Example (63) shows that the same construction is used for both inalienable, (63-a), and alienable possession, (63-b).²¹

- (63) a. enikku chechi undu/*aanu
 I.DAT older.sister be.PRES
 ‘I have an older sister.’
- b. enikku car undu/*aanu
 I.DAT car be.PRES
 ‘I have a car.’

That the same copula should be used in both the existential and the possessive is unsurprising. Much work since Benveniste (1966) including Freeze (1992), den Dikken

²¹Menon (2016) claims that *aanu* is possible in (63-b). However, speakers I have presented this sentence to responded by asking me what I was trying to say. They said it was an ungrammatical sentence and corrected it to *enikku kaaru undu*. When asked if it was possibly a dialect variant/if they had ever heard anyone else say that sentence, they then came up with the context given in (i) in which *aanu* could be used.

- (i) a. tann-ikku scooter und-oo?
 you-DAT scooter be.PRES-Q
 ‘Do you have a scooter?’
- b. alla, enikku caaru aanu
 NEG.be I.DAT car be.PRES
 ‘No, it is a car that I have.’

In other words, this structure can only be used in a cleft construction contrasting that it is a car as opposed to something else that is possessed.

(1995, 1997, 2006), among many others, has argued for a decompositional account of ‘have’ verbs into ‘be’ plus a preposition in a number of languages from Finnish to Tagalog. In languages that lack a ‘have’ verb, an oblique case marked subject plus the existential copula are used instead. This is exactly what is found in Malayalam.

The facts in Spanish²² are more or less parallel to the Malayalam facts at first glance: *aanu* is used in the same type of sentences where *ser* is used. Examples (64-a)-(64-b) provide the parallel Spanish sentences for the Malayalam sentences in (60-a)-(60-b). The first difference between the two languages, however, can be seen by comparing (60-c) and (64-c). In Malayalam, (60-c), only *aanu* can be used, while in Spanish, (64-c), either copula can be used. When *ser* is used, the sentence makes a statement about Alejandro’s general character. When *estar* is used, it makes a comment about Alejandro’s current behavior.

- (64) a. Maria es/*esta la hermana de Juan.
 Maria SER/ESTAR the sister of Juan
 ‘Maria is John’s sister.’
- b. El partido es/*estar a las seis.
 The match SER/ESTAR at the six
 ‘The match is at 6pm.’
- c. Alejandro es/esta agradable.
 Alejandro SER/ESTAR pleasant
 With SER: ‘Alejandro is pleasant (in general).’ With ESTAR: ‘Alejandro is being pleasant (today).’ (Camacho 2012a: 1)

Unlike in Spanish, in Malayalam only *aanu* is possible with a predicative state. For *undu* to be used, in (60-c) the adjective *sundaran* ‘beautiful’ must be changed to the noun *saundayam* ‘beauty’ and there must be a dative subject. In other words, a possessive construction must be used.

In sum, the data presented so far can be summarized in Table 3.9.

Spanish, unlike Malayalam, uses neither *ser* nor *estar* to express either existentials or possessive constructions. Instead, it has independent verbs meaning ‘exist’, *existe*, and ‘have’, *tener*. That the two languages differ on this point should not be a major

²²Thanks to Mar Bassa Vanrell for her Spanish judgments.

-	undu	estar	aanu	ser
Equative/predicative use	-	-	-	
X is Y's sister	N	N	Y	Y
The match is at 6pm	N	N	Y	Y
He is beautiful/agreeable	N	Y (currently)	Y	Y (usually)
Possession	Y	N	N	N
Existential use	Y	N	N	N

Table 3.9: Comparison of the Spanish and the Malayalam copulas

deterrent to a hypothesis that what *estar* is to Spanish, *undu* is to Malayalam and what *ser* is to Spanish, *aanu* is to Malayalam. However, the data in the next section, in addition to the facts in (60-c) and (64-c), are more damaging for such an account.

The functions of the Malayalam copulas presented in this section are well known and easily determined, as they are in complementary distribution in these constructions. However, this complementary distribution breaks down in location, medical condition predicates and psychological predicates.

3.5.2 Location, psychological and medical predicates

This section will show that a subtle meaning difference occurs in location, psychological and medical predicates when *undu* versus *aanu* is used. The facts regarding these predicates are noticeably different than in Spanish. In the next section, it will be argued that the Malayalam facts might be better explained via the notion of ‘immediacy.’

Let us first turn to location predicates. The examples (65) show that *undu* and *aanu* can both be used to express locations. When asked out of the blue, speakers find it notoriously difficult to differentiate the meanings of the sentences in (65). Either sentence could be an appropriate response to a question like (66), depending on what subtle meaning the speaker wants to convey.

- (65) a. njaan delhi-yil undu.
I Delhi-LOC be.PRES
‘I am in Delhi.’

- b. *njaan delhi-yil aanu.*
 I Delhi-LOC be.PRES
 ‘I am in Delhi.’

- (66) *enth-okke undu vishesham?*
 what-all be.PRES news
 ‘What’s new?’

If for example one calls a friend that one has not talked to in some time just to chatch up and, after greeting the person being phoned, asks (66) and that person responds with (65-a), the person calling will say something like ‘oh, sorry for catching you at a bad time, I’ll call back later.’ This is because using (65-a) in this contexts is like saying ‘I am in Delhi, so I am busy now.’ If, on the other hand, the speaker responds with (65-b), the person calling will continue with some follow up questions about what that person is doing in Delhi and the conversation will go on. This data shows that using *aanu* to give a location is simply a neutral statement about location.²³ The use of *undu*, however, has some special effects.

The use of *undu* versus *aanu* is not linked to temporary or permanent place since both sentences in (65), could be used to describe either a temporary or a permanent (in the sense of settlement) position; instead the relevant factor is whether or not the speaker wants to make a neutral statement or a statement that conveys that the present location has some kind of immediate implication for the hearer, for example that there is no time to talk now. This implication does not have to negative. For example, if the speaker is in town unexpectedly and phones their friend, they might say (65-a) as a way to indicate a desire to meet the other person.

Another example that shows the special effects is (67)

Scenario: People in the department like to eat lunch together. Today the lab technician, Unni, is not present at the lunch. However, his friend Nithin is there. Usually, Nithin only comes to lunch when Unni comes. A third person comes in and,

²³It is possible to use (65-b) to express something like ‘I’m in Delhi so I’m helpless;’ however this is a clefted use. For example, if someone calls me and asks me to do something for him, thinking I am in my office in Kochi. I can say (65-b) to express that I am in Delhi not Kochi and so am unable to help that person. Clefted readings are freely available with *aanu* but these are not the readings being focused on in this section.

seeing Nithin but not Unni, and asks with surprise, ‘Where is Unni?’

- (67) a. unni lab-il undu
Unni lab-LOC be.PRES
‘Unni is in the lab.’
- b. unni lab-il aanu
Unni lab-LOC be.PRES
‘Unni is in the lab.’

Here (67-a) is the most natural response because it conveys that right now, Unni is in lab (i.e. has a lot more work than usual) and that is why he is not at lunch, despite the fact that Nithin is there. The use of *undu* is used to communicate about the situation immediately at hand. If (67-b) is used, it conveys that Unni is in lab because that is normally where he works; it is a statement about the general situation, not the current situation. As such, it does not answer the question being asked in this context. If said, it would leave the hearer with a ‘and so.?’ feeling, i.e. more information would need to be added. A cleft reading is also possible in (67-b), as in most cases where *aanu* is present. What is interesting to note is that there is an additional, non-clefted, reading possible in (67-b) as well.

Another place where the special effects with *undu* can be seen is in (68). Example (68-a) is not a good general question. Instead it needs to a context like the following to be licensed: ‘Unni’ is known to be somewhat of a character and the speaker wants to ask something like ‘Where is that guy? What is he up to now?/What kind of trouble is he getting into now?’ Example (68-b) is what would be used to simply ask a general question.

- (68) a. unni evide undu?
Unni where be.PRES
‘Where is Unni?’
- b. unni evide aanu?
Unni where be.PRES
‘Where is Unni?’

It is only acceptable to answer such a question with (69-a) if ‘Unni’ can be seen by

the person answering the question, say because he is in the room with this person. If he cannot be seen, say because he is upstairs, then (69-b) would be the correct way to answer the question.

- (69) a. unni ivide undu.
 Unni here be.PRES
 ‘Unni is here.’
- b. unni ivide aanu.
 Unni here be.PRES
 ‘Unni is here.’

One necessary condition for the use of *undu* is the person/thing must be mobile. For example, it is possible to use *undu* with a person, (70-a) or a mobile object such as a book, (70-b), but it is not possible to use *undu* with the location of an immobile object like a city, (70-c).

- (70) a. unni kochi-yil undu
 Unni kochi-LOC be.PRES
 ‘Unni is in Kochi.’
- b. aa pusthakam library-il undu
 that book library-LOC be.PRES
 ‘That book is in the library.’
- c. #kochi kerala-thil undu
 kochi kerala-LOC be.PRES
 ‘Kochi is in Kerala.’

Example (70-b) would be used as an answer by a librarian to a student wanting to check out the book, who inquired if it was in the library or not. If *aanu* is used here, then the sentence simply states the normal location of the particular book, i.e. that since it is a reference book, all normal circumstances holding, it will be in the library. Saying (70-c) sounds comical because this sentences makes it sound like Kochi, a city, has just arrived in Kerala and so that event requires some immediate action on the hearers part. In other words, it is a funny sentence because it suggests that Kochi is traveling. That Kochi is in Kerala is a fact about the way things generally are and so only the *aanu* copula is allowed to express the location of non-mobile things like

cities.²⁴

In sum, both copulas can be used to express the location of mobile things/persons. When the speaker wants to convey that the location is not just a general statement but immediately relevant to the situation at hand, *undu* is used. For statements about how things usually are *aanu* is used. Let us now compare these facts with the Spanish ones. The examples in (71) show that in unlike Malayalam, where both copulas can be used with subtle shifts in meaning, only *estar* is possible in the Spanish equivalents of the location predicates seen above.²⁵

- (71) a. Juan *esta/*es* en Madrid
Juan *ESTAR/SER* in Madrid
'Juan is in Madrid.'
- b. El libro *esta/*es* en la biblioteca
the book *ESTAR/SER* in the library
'The book is in the library.'
- c. Juan *esta/*es* en el laboratorio
Juan *ESTAR/SER* in the lab
'Juan is in the lab.'

The next example shows the reverse case where Spanish allows both copulas and Malayalam only allows *aanu*, (72). Also recall from (64-c) above, that Spanish can use either copula (with a meaning shift) with a predicative state, while Malayalam allows only *aanu*, (60-c).

²⁴At first glance, one apparent counter example might seem to be the sentences in (i). In Spanish either *ser* or *estar* could be used in this context (Camacho 2012a). When asked, speakers will say both sentences are possible in Malayalam as well. However, they are the answers to different questions. Example (i-a) is an answer to the question 'Where is the bathroom?' while (i-b) is the answer to the question 'Do you have a bathroom?.'

- (i) a. bathroom *avide aanu*
bathroom there be.PRES
'The bathroom is there.'
- b. bathroom *avide undu*
bathroom there be.PRES
'We have a bathroom there.'

²⁵*Ser*, though not allowed in (71-c) in Spanish, is allowed in Catalan, however (Mar Bassa Vanrell, pc).

- (72) Madrid es/esta en España
 Madrid SER/ESTAR in Spain.
 ‘Madrid is in Spain.’

In the first part of this section, it seemed that *undu* was roughly comparable to *estar* and *aanu* was roughly equivalent to *ser*. However, this comparison has been challenged by location predicates. The data here has shown that the Malayalam and Spanish facts differ in a number of ways, summarized in 3.10. With respect to Malayalam, the generalization is that when the speaker wants to convey that the location is not just a general statement but immediately relevant to the situation at hand, *undu* is used. For statements about how things usually are *aanu* is used.

location	<i>undu</i>	<i>estar</i>	<i>aanu</i>	<i>ser</i>
Person is in city	Y(imm)	Y	Y	N
Book is in library	Y(imm)	Y	Y	N
Person is in lab	Y(imm)	Y	Y	N
City is in state	N	Y	Y	Y
Bathroom is there	Y (have)	Y	Y	Y

Table 3.10: Copulas in location predicates in Malayalam and Spanish

Psychological predicates are another area where complementary distribution between *undu* and *aanu* breaks down and where speakers have trouble differentiating the meaning between sentences using the different copulas out-of-the-blue. Menon (2008, 2016) claims that with most psychological predicates only the *undu* copula can be used. There seems to be some speaker variation though with respect to the facts. Speakers that I consulted also accepted *aanu* in all cases but noted that the meaning that its use is often dispreferred in daily contexts. All speakers tend to prefer *undu* to express psychological predicates due to the fact that *undu* is used to express ones feelings about an immediate situation at hand. In that way, one makes the minimal comment about ones feelings. When *aanu* is used, a statement is made about the way things are. Given that a weaker, more immediate alternative is available, the use of *aanu* in daily life can feel overly expressive or emotive. The rest of this subsection provides relevant examples.

One example that shows the psychological predicates show the same types of

special usages found with *undu* in location predicates is as follows.

Scenario: Normally, I love dogs and am not afraid of them at all. However, one night I am walking home and two angry looking dogs starts coming my way.

- (73) a. enikku (pattigal) pedi aanu
I.DAT dogs fear be.PRES
'I am afraid (of dogs).'
- b. enikku (pattigal) pedi undu
I.DAT dogs fear be.PRES
'I am afraid (of dogs).'

In this context, (73-a) is not an acceptable thing to say since the speaker generally is not afraid of dogs. Example (73-b) is the right thing to say in this context because it communicates that in the immediate situation, the speaker is afraid of those dogs and wants the person hearing him/her to help in some way. People find (73-a) inappropriate in the situation given, as it does not convey enough fear in the situation. Several speaker commented that it would be like turning to one's friend and making a general statement such as, 'I like to eat ice cream' in the face of an imminent calamity, in this case a bite by a wild dog. Example (73-a) can be correctly used in this scenario given above if it has a clefted meaning. Here there is an assumption that the dropped object refers to wild dogs as opposed to pet dogs, a common pragmatic leap given that there is a large wild dog population in Kerala.

Another examples comes from the predicate *sheenam* 'tired.'

- (74) a. enikku sheenam aanu
I.DAT tired be.PRES
'I am tired.'
- b. enikku sheenam undu
I.DAT tired be.PRES
'I am tired.'

If someone asks how you are and you simply want to express that now you are feeling tired but otherwise fine and are planning on pushing through despite your tiredness, (74-b) should be used. If (74-a) is used, the hearer will tell you to go lie down and

take rest since your general state is one of exhaustion.

Example (75-a) would be said to express that generally, ‘Unni’ has a strong anger towards something, say bureaucratic hassle. When *undu* is used, (75-b), it means that Unni is angry due to a particular situation currently at hand.

- (75) a. unni-kku desham aanu
Unni-DAT anger be.PRES
‘Unni is angry (at some person/situation)’
- b. unni-kku desham undu
Unni-DAT anger be.PRES
‘Unni is angry (at some person/situation).’

With a predicate like *sneham* ‘love’, *aanu* once again expresses permanency and fullness of feelings. Using *undu*, (76-b), is more common because, generally, people do not love each other so fully and permanently. It is important to note that that using *undu* does not convey that the speaker does not genuinely love the person under discussion, just that he is making a comment that is limited to the immediate situation; he is making no comment about who he generally loves. To use *aanu* is to make a very strong statement. One exception is when expressing love towards one’s mother. If ‘Unni’ wants to say he loves his mother (76-a) would be the most natural way to express this because, generally, one is in a state of loving one’s mother and it is generally positive to make such strong statements about ones feelings towards ones mother.

- (76) a. unni-kku sneham aanu
Unni-DAT love be.PRES
‘Unni loves (someone).’
- b. unni-kku sneham undu
Unni-DAT love be.PRES
‘Unni loves (someone).’

Undu is also more frequently used with *santhosam* ‘happiness’ because usually people are not in a general state of deep happiness. However, if say, a child who is living abroad calls his/her father suddenly to say he/she is planning a trip home soon, the

child's father can say (77-a) to convey his great happiness, i.e. how that phone call put him into a general state of happiness, not merely happiness with the situation at hand.

- (77) a. enikku santhosam aanu
I.DAT happiness be.PRES
'I am happy (with someone/some situation).'
- b. enikku santhosam undu
I.DAT happiness be.PRES
'I am happy (with someone/some situation).'

When it comes to psychological predicates, the use varies based on the speaker understanding and conceptualization of these types of feelings: the line between what is a general feeling and what is in reaction to a particular situation seems to differ somewhat among speakers. A concrete example of this comes from speakers who reject the use of *aanu* with predicates like *nirabandam* 'obligation' due to the fact that they feel they have no general obligations in life that are so strong (towards family members, God, etc.), though in particular circumstances they do have such obligations, in which cases they would use *undu*. On the other hand, if a devout Muslim is asked, they will affirm that it is extremely odd to use *undu* when talking about the obligation to pray five times a day. In this context, only (78) would be used. This fits with other general comments that speakers have made that the use of *aanu* is somewhat determined by ones community, socioeconomic status, family practices and individual beliefs/personality.

- (78) anju neram niskaram nirabandam aanu
five times praying obligation be.PRES
'I am obligated to pray five times a day.'

Predicates describing medical conditions also show this special 'immediacy' behavior with *undu*. For example, if your friend Unni has been sick for a few days and you want to give the latest development/his condition right now, (79-b) should be

used.²⁶

- (79) a. unni-kku pani aanu
Unni-DAT fever be.PRES
'Unni has a fever.'
- b. unni-kku pani undu
Unni-DAT fever be.PRES
'Unni has a fever.'

To inquire about Unni's general condition, (79-a) should be used, i.e. this is a good answer to the questions such as 'How is Unni/is Unni well?' and 'Why isn't Unni in the office today?'

In the case of diabetics, both copulas can also be used. Example (80-b) might be said in response to the question 'What happened to you? You look weak now.' It might also be an answer on a form one fills out when they go to enroll in new school or job, i.e. in answer to a question such as 'What facts should the school/job know about you?' Example (80-a), with *aanu*, would be limited to contexts such as a general educational pamphlet about diabetics, say one of the type that might be distributed in schools to raise general awareness.

- (80) a. enikku prameham aanu
I.DAT diabetics be.PRES
'I am a diabetic.'
- b. enikku prameham undu
I.DAT diabetics be.PRES
'I am a diabetic.'

The temporariness or permanence of the condition does not matter here. If someone asked the question 'What happened to you? You look weak now.' or 'Is there anything we should know about you?' (say in the context of joining a new job), (80-b) would be the correct response, irrespective of whether the speaker is a type 2 diabetic who has

²⁶It can also be the response in a scenario where there is some doubt about whether our compaymate 'Unni' is really sick or if he has simply called in sick in order to go to the beach with his friends. In this scenario, (79) should be used to confirm that Unni really is sick, i.e. it provides *verum focus*. Menon (2016) also notes this use of *undu* with location predicates. She comments "undu is used to ask whether the entity is where it is expect to be" p102.

to take daily insulin shots and very carefully manage her diet or if she has developed a mild, temporary case of diabetics due to a pregnancy. Rather, what is relevant here is whether information about the general situation or information about its relevance to a specific situation currently at hand is being given.

The range of uses between *undu* and *aanu* in Malayalam could be summarized in Table 3.11.

<i>undu</i>	<i>aanu</i>
Existential	equative
Possession	Predicative
Immediate locations	general locations
Immediate feelings	general feelings
Immediate medical condition	general medical conditions
Verum focus	Clefts
Existential, episodic ‘imperfective’	progressive (intensional)

Table 3.11: Summary of the uses of the two copulas in Malayalam

In contrast, Spanish does not exhibit this sensitivity to immediacy. Example (81-a) shows that Spanish, unlike Malayalam, is sensitive to the permanence or temporariness of the type of diabetics. The sentence in (81-b) with *ser*, unlike sentences with *aanu* in Malayalam, has a fixed meaning of a general trait of the person. It cannot be used, as *aanu* can be, to express that that ‘Juan’ did not come to the office because he is sick today. The sentence in (81-c) shows that it is not possible to use *ser* with psychological predicates, while it is possible to use *aanu* with them in Malayalam.

- (81) a. Maria esta/es diabetico.
 Maria ESTAR/SER diabetic
 With ESTAR: ‘Maria is a type 1 diabetic/has temporarily become diabetic due to pregnancy, etc.’
 With SER: ‘Maria is a type 2 diabetic.’ (most normal usage)
- b. Juan esta/es enfermo.
 Juan ESTAR/SER sick
 With ESTAR: Juan is sick and will hopefully recover soonish
 With SER: Juan is crazy.

- c. Juan esta/*es enojado/enamorado/content con Maria.
 Juan ESTAR/SER angry/in.love/happy with Maria
 ‘Juan is angry/in love/happy with Maria.’

Given the variety of empirical differences between Spanish and Malayalam, something beyond what has been said for Spanish needs to be said. The next section will offer a suggestion.

3.5.3 The immediacy requirement: towards an account for *undu* and *aanu*

This section extends the immediacy account for negative imperatives (Patel-Grosz 2016) to the copulas in Malayalam. It begins with a brief summary of Patel-Grosz (2016). This work points out in those languages that do not have dedicated negative prohibitive markers, in contexts of immediacy, special markers/positions do appear. It provides examples from East Austrian German, Norwegian, Kutchi Gujarati and English. In East Austrian German and Norwegian, imperatives occurring with pre-verbal negation are only possible in immediate contexts, such as when someone in a bar is lighting a cigarette in front of the speaker, (82-a), or when the speaker is sitting in a room full of gas, (83). Post verbal negation in East Austrian German functions as sentential negation and allows both immediate and non-immediate interpretations, (82-b).

East Austrian German

- (82) a. Net raoch!
 Not smoke.IMP
 ‘Dont you smoke! (Put out that cigarette!)’ #‘don’t smoke (in general)!’
- b. Raoch net!
 Smoke.IMP not
 ‘Don’t you smoke! (Put out that cigarette!)’
 ‘Don’t smoke (in general)!’ (Patel-Grosz 2016 p8: 33)

Context: People are sitting in a room full of petrol Norwegian

- (83) a. Ikke ten fyrstikken!
 NEG light.IMP match.the
 ‘Don’t light the match!’
- b. #Tenn ikke fyrstikken!
 Light.IMP NEG match.the
 ‘Dont light the match!’ (Patel-Grosz 2016 p10: 43)

East Austrian German

- (84) a. Wennst oid wern wust, muast gsund bleibn.
 If.2SG old become want.2SG must.2SG healthy stay
 ‘If you want to become old, you have to stay healthy...’
- (i) #Net raoch! #Net trink!
 Not smoke.IMP not drink.IMP
 ‘Don’t smoke!’ ‘Don’t drink!’
- (ii) Roach net! Trink net!
 Smoke.IMP not drink.IMP not
 ‘Don’t smoke!’ ‘Don’t drink!’ (Patel-Grosz 2016 p8: 34)

Preverbal negation is also ruled out in ‘life advice scenarios’ in East Austrian German, (84) where it is not possible for the situation to be immediate. Kutchi Gujarati expresses negative prohibition in immediate contexts with the preverbal negation form *na*. Patel-Grosz notes that this form appears in declarative sentences as regular sentential negation, (85).

Kutchi Gujarati

- (85) a. Valji dhor-yo
 Valji run-PERFV.M.SG
 ‘Valji ran.’
- b. Valji dhor-yo ni
 Valji run-PERFV.M.SG NEG
 ‘Valji didnt run.’
- c. Valji na dhor-yo
 Valji NEG run-PERFV.M.SG
 ‘Valji didn’t run.’

However, when it is used with an imperative it functions as a specialized prohibitive,

(86-c). Like preverbal negation in East Austrian German, Kutchi Gujarati cannot use the preverbal *na* negation with an imperative in a life advice scenario, (87).

- (86) a. Dhor!
Run.IMP
'Run!'
- b. Dhor ni!
Run.IMP NEG
'Don't run!' (regular negated imperative)
- c. Na dhor!
NEG run.IMP
'Don't you run!' (specialized prohibitive)
- (87) a. tamne bimari vagar-na chokra-ne mota karva che, tho:
'If you want to raise healthy adults, then:'
- b. #biri na pi!
Cigarette NEG drink.IMP
'Don't you smoke!'
- c. Biri pi ni!
Cigarette drink.IMP NEG
'Don't smoke.'
- (88) a. aa chai na pi!
This tea NEG drink.IMP
'Don't you drink this tea!'
- b. #aa chai pi ni!
This tea drink.IMP NEG
'Dont drink this tea!' (Patel-Grosz 2016 p9:38-41)

English negative imperatives with an overt subject have the same distribution as East Austrian German imperatives with preverbal negation and Kutchi Gujarati preverbal *na* negation. They can only be used to express prohibition in the situation at hand, not a general prohibition, (89), and they cannot be used in life advice scenarios, (90).²⁷

²⁷Norvin Richards (pc) points out that there is a potentially confounding factor with 'don't you' imperatives in that they involve a particularly strong emphasis and thus, in addition to 'situation at hand' cases, they can also be used with general advice cases where the advice is particularly passionately given, for example, a doctor who cares a lot about keeping children away from smoking could say 'Here's my advice: don't spank them, don't let them be exposed to lead paint, and for

- (89) a. Don't you touch me!
 b. Don't you call him!
 c. Don't you smoke in front of the children!
- (90) If you want to raise healthy adults, here's part of my advice
 a. #Don't you smoke in front of the children!
 b. Don't smoke in front of the children! (Patel-Grosz 2016 p8: 35-36)

In sum, a number of languages encode an immediacy requirement in negative imperatives.

In the previous section the Malayalam copula data in locative, psychological and medical predicates also show sensitivity to the immediate context: *undu* was used to express immediacy while *aanu* expressed general statements. Three representative causes are summarized below.

First, for location predicates both copulas can be used with different meanings: if one calls a friend just to chat and is told, after asking the person 'what's new?', (91-a), they will then say something like 'oh, sorry for catching you at a bad time. I'll call back later.' If, on the other hand, a friend calls unexpectedly saying they are in Delhi (where the hearer lives), (91-a) expresses that the speaker wants to meet the hearer since they are in town. This is because the use of *undu* suggests that there is some action required in the immediate context, in the same way that saying 'Don't you smoke!' means 'Put out that cigarette!'. The use of (91-b) is just a neutral, general statement about the location of the speaker.

- (91) a. njaan delhi-yil undu.
 I Delhi-LOC be.PRES
 'I am in Delhi.'

heaven's sake, don't you dare smoke in front of them!' even if he knows the parents are non-smokers (and have showed no signs of planning to start smoking). However, the basic point that, without this passionate/emphatic advice context, the 'don't you' construction only fits with 'situation at hand' cases stands. *Undu*, the copula proposed to be an immediacy marker in Malayalam, also has some type of passionate/emphatic component, as can be shown by its verum focus uses. One might surmise that these uses might be an indirect result of the immediacy requirement, as such situations often involve a dispute or point of doubt related to a current conversation or immediate command.

- b. njaan delhi-yil aanu.
 I Delhi-LOC be.PRES
 'I am in Delhi.'

In psychological predicates, the use of *undu*, (92-b), is often preferred because this only makes reference to the feelings about a certain situation and does not comment about general feelings. The implication is that, since some particular circumstance has resulted in 'Unni' loving that person, that will lead to some type of 'special' behavior/strengthened appreciation towards that person in the immediate context. The fact that (92-b) can be used without implying that 'Unni's' love towards that person is temporary/not genuine is a direct result of the fact that only a comment about the immediate situation is being made. A general comment is not being made here. For that, (92-a) should be used.

- (92) a. unni-kku sneeham aanu
 Unni-DAT love be.PRES
 'Unni loves (someone).'
- b. unni-kku sneeham undu
 Unni-DAT love be.PRES
 'Unni loves (someone).'

In medical predicates, both copulas may be used but with slightly different meanings. Example (93-b) would be used in a context where someone was having a diabetic attack or when replying to a question about any health conditions a school should be aware of. In both cases, this information requires immediate action (say, helping someone get to the doctor or putting a flag in the file to alert the proper teachers of the condition so the child can be monitored). Example (93-a) is used for making a general comment about the speaker being a diabetic; it might be used in an information pamphlet circulated to raise general awareness among diabetic and non-diabetic people.

- (93) a. enikku prameham aanu
 I.DAT diabetics be.PRES
 'I am a diabetic.'

- b. enikku prameham undu
 I.DAT diabetics be.PRES
 ‘I am a diabetic.’

The temporariness or permanence of the condition does not matter here. If someone asked the question ‘What happened to you? You look weak now.’ or ‘Is there anything we should know about you?’ (say in the context of joining a new job), (80-b) would be the correct response, irrespective of whether the speaker is a type 2 diabetic who has to take daily insulin shots and very carefully manage her diet or if she has developed a mild, temporary case of diabetics due to a pregnancy. Rather, what is relevant here is whether information about the general situation or information about its relevance to a specific situation currently at hand is being given.

Returning to the data that instigated the investigation of the copulas in Malayalam, it seems that an immediacy requirement is also active here. One explanation for why in (94-b) only the ‘event-in-progress/progressive’ use is possible is that the ‘generic’ use is not relevant enough to the immediate context at hand, which is the contribution *undu* is making here.

- (94) a. suuryan kizhakku udhikk-unnu- \emptyset
 sun east rise-IMPV-PRES
 ‘The sun rises in the east.’ [generalization over a series of episodes of individual risings] or ‘The sun is rising in the east.’
- b. suuryan kizhakku udhikk-unn-undu
 sun east rise-IMPV-be.PRES
 ‘The sun is rising in the east.’ #‘The sun rises in the east.’ (Hany Babu 2006)

Another fact that is encouraging for such an explanation comes from speakers comments about when it is appropriate to use the forms in (96). Specifically, if ‘Unni’s’ father calls ‘Unni’s mother’ and asks (95), if ‘Unni’s’ mother can see ‘Unni’, then she can reply with (96-a). If ‘Unni’ cannot be seen by his mother, say because he is upstairs, then (96-b) would be the correct way to answer the question. This comment is very similar to the comments speakers made about the role of visual evidence in

licensing the ‘running context’ interval, *i*, that is needed for the felicitous use of the *-unnu* ‘imperfective’. Perhaps the immediate context present with some uses of *undu* sometimes overlaps with the ‘running context’ and/or helps identify this interval *-unnu* requires. This ‘overlap’ may be the reason for the verum focus effects *undu* triggers. In any case, *-unnu* was argued to be existential in nature. The fact that an existential operator would pair with a copula that encodes information about the immediate situation seems reasonable.

(95) unni evide undu?
 Unni where be.PRES
 ‘Where is Unni?’ (‘Where is that guy? What is he up to now?/What kind of trouble is he getting into now?’)

(96) a. unni ivide undu.
 Unni here be.PRES
 ‘Unni is here.’
 b. unni ivide aanu.
 Unni here be.PRES
 ‘Unni is here.’

Given the data in this section, it seems that *undu* is not merely an auxiliary in the sense of Bjorkman (2011, under review): it is spelling out some additional content in addition to tense features, hence the immediacy requirement in some cases. That having been said, this section leaves many key questions unanswered. For example, how exactly immediacy is defined and how exactly a speaker determines whether a given situation counts as being immediant or not is not clear at this point. Additionally, there seem to be a number of pragmatic and dialect factors at play in determining immediacy in Malayalam. Future work will need to further investigate these points. This section has shown though that the Malayalam copulas do not parallel the use of the different copulas in Spanish. Given the nuances of meaning described above for Malayalam, the immediacy hypothesis seems like a promising intuition for an account that can capture the full range of the Malayalam data.

Another question that this section raises is why the immediacy requirement is

found only with locative, psychological and medical predicates but not with possessive or existential uses of *undu*. One might simply say there are two distinct *undus*, but this is not deeply explanatory. Another idea might be to say that *undu* is undergoing some type of perspective shift, which limits the existence of the locative, psych and medical condition readings to a time that is immediately local to a particular moment. What exactly triggers this perspective shift/why existential and possessive uses of *undu* are never in the scope of the shifting operator is not yet clear, but there are at least two reasons such an account is plausible. First, Swenson & Marty (under revision) argue that certain pronouns in Malayalam are perspective sensitive items, i.e. Malayalam is a language that is already known to allow some perspective shift. Secondly, it has been established that tenses can function as shifting indexicals (Schlenker (1999)). One might worry that indexical shift involves intensional operators while *-unnu* has been argued to be an extensional operator. However, all the sentences used to show that *-unnu* was existential, lacked the *undu* copula. Perhaps this fact is meaningful. One could also explore some type of syntactic explanation for these facts, perhaps taking inspiration from something along the lines of Diesing (1992). Differentiating between these options is left to future work.

Now let us turn to an overarching intuition for the role of *aanu*. It will be argued that *aanu* is the elsewhere copula. One motivating piece of data is that in (97). In light of the data presented so far, the example in (97-b) below is surprising. Earlier sections showed that *aanu* is required in copular sentences with non-mobile objects such as cities. Using *undu* in these copular constructions resulted in the odd meaning that the city was moving from place to place and that the current location was only the city's present location. In (97-b), however, the use of the progressive, which contains the *aanu* copula results in the odd, present location reading. This is not an effect that is expected with *aanu*.

- (97) a. kochi periyarinte azhimkha-thu sthithi cheyy-unnu- \emptyset /#undu
 Kochi Periyar-GEN mouth-DAT position do-IMPFV-PRES
 'Kochi lies at the mouth of the Periyar (river).'

- b. #kochi periyar-inte azhimkha-thu sthithi cheyy-uka(y)-aanu
 Kochi Periyar-GEN mouth-DAT position do-PROG-be.PRES
 ‘Kochi is lying at the mouth of the Periyar (river).’ [makes it sound like
 Kochi can move and this is just its present location]

Following Dowty (1979) I propose that this effect is a result of the progressive marker combining with a predicate with a non-mobile subject, as this problem does not appear with a mobile subject, (98). In other words, it is not really about the copula. However, what this example shows us is that *aanu* probably does not have a semantics that encodes any information about the general state of a persons feelings or health. If it did, such a meaning would need to be bleached each time it was used in the progressive. While this is not impossible, the simplest move seems to be to say that it is an elsewhere copula. Any effects of long term or strong feelings most probably are gained via pragmatic principles specifying that since an ‘weaker alternative discussing only the immediate context was available but not used, the speaker intends a stronger meaning.

- (98) a. sari kidakkay-ude kiizhe kidakk-unnu- \emptyset /undu
 sari bed-GEN under lie-IMPFV-PRES/be.PRES
 ‘The sari is lying under the bed.’
 b. sari kidakka-yude kiizhe kidakk-uka(y)-aanu
 sari bed-GEN under lie-PROG-be.PRES
 ‘The sari is lying under the bed.’

This fact, in combination with the fact that *aanu* is used as a copula to express non-immediate situations elsewhere, suggests that *aanu* is an elsewhere copula.

This section has argued *undu* is the existential copula also used to express possession. When it is used in location, psychological and medical predicates, it expresses immediate situations (cf. Patel-Groszs (2016) immediacy requirement in negative imperatives cross-linguistically). It was suggested that the immediacy requirement that *undu* sometimes carries perhaps can explain why *undu* is the coupla used in *-unnu* ‘imperfectives.’ *aanu* was argued to be the elsewhere copula that is a true auxiliary in the sense of Bjorkman (2011, under review).

3.6 Chapter summary

This chapter began with an overview of Amritavalli & Jayaseelan’s (2005) proposal that Malayalam, along with the other Dravidian languages, is tenseless. It was then pointed out that it is possible to accept Amritavalli and Jayaseelan’s assertion that ‘finiteness’ is not linked to tense in Dravidian without accepting their claim that Dravidian languages lack tense morphology and a TP. The first part of this chapter highlighted the difficulty of the tense-aspect puzzle in Malayalam and then showed that while Amritavalli & Jayaseelan could be right about what counts as finiteness/anchoring in Malayalam, the assertion that Malayalam is tenseless is not empirically supported. The first half of this chapter shows that Malayalam is empirically different from other tenseless languages and does have morphology that encodes tense semantics, making it a tensed language for those in the ‘no overt morphology’ camp.

The second section provided a sketch of an analysis for tense and aspect in Malayalam. The first subsection argued that if Malayalam has a TP with tense features, which spell out as tense morphemes when nothing intervenes between the verb and T (a la Bjorkman 2011, under review), and as auxiliaries when another active head intervenes, this explains the distribution of auxiliaries and the obligatory nature of predicative copulas in Malayalam. Having a TP would make Malayalam a tensed language for those in the ‘no TP’ camp.

How exactly the intricacies of tense semantics work in Malayalam, for example whether a quantificational or pronominal approach to tense is best, was left for future research. The point of this chapter was simply to show via the adverb, context, Universal perfect, past progressive, auxiliary and predicative copula data that Malayalam does have tense in a Klein (1994) sense and a TP.

The second part of the chapter took a closer look at the semantics of the *uka* and *unnu* forms, what have been generally called the two ‘imperfectives’. It was first shown that *uka* is an intensional progressive while *unnu* is used when a situation involves multiple, temporally connected episodes taking place within close succession,

like an iterative. But it differs from an iterative in that it cares that these iterations take place within another interval, *i*, in the actual world. Because this interval has or gets the subinterval property, it results in accidental generalizations over these episodes. Because the Topic Time is contained in the Situation Time, this gives a Klein (1994) progressive meaning while the ‘generalizing’ step that gives the progressive meaning also results in a report on the state of things in the actual world, i.e. the ‘generic’ use of *unnu*. This results in it having the appearance of an imperfective.

Finally, an in depth look at copula usage was undertaken. The main conclusion was that *undu* is the existential copula also used to express possession. When it is used in location, psychological and medical predicates, it expresses immediate situations (cf. Patel-Grosz’s (2016) immediacy requirement in certain negative imperatives cross-linguistically). *aanu* was argued to be the elsewhere copula.

Chapter 4

Non-finite clauses in Malayalam

The previous chapter sketched the beginning of an account for how ‘finite’ clauses obtain their temporal interpretations in Malayalam. It showed that even if Amritavalli & Jayaseelan (2005) are right that finiteness in Malayalam should be understood as anchoring via worlds rather than times, there are still reasons to believe that Malayalam has a TP and tense morphology. That finiteness might be expressed via anchoring by worlds in Malayalam is plausible (cf. Ritter & Wiltschko 2005, 2009, 2014), but I will leave a targeted verification of this claim to future research. In this chapter, the focus will be on non-finite forms.

Cross-linguistically, languages can have a number of ‘non-finite’ forms. While they all share the property of being ‘non-finite’ because they are missing whatever counts as ‘finite’ in that language, they generally differ from each other in a number of ways. Gaining an understanding of the empirical consequences of the different types of clausal structure present in non-finite forms cross-linguistically, will help us reach a deeper understanding of individual languages and also provide insight into the meaning of finiteness cross-linguistically.

The goal of this chapter is to look more closely at three specific forms that have been classified as being non-finite in Malayalam. These forms have all been classified as ‘non-finite’ because they are missing ‘something.’ What exactly that ‘something’ is is not clear. Work by Abney (1987) and Stump (1985), a.o. has improved our understanding of different ‘non-finite’ forms in English. Nikolaevas (2010) typological

survey of finiteness suggests that what makes a non-finite clause non-finite is that it is not wholly ‘verbal’ rather it is of a mixed nature. Gerunds and infinitives are claimed to have properties of both verbs and nouns (Comrie 1976, Koptjevskaja-Tamm 1993, also see Abney 1987, Baker 2011) while participles are claimed to have the properties of both verbs and adjectives (Haspelmath 1994). To date in the generative literature, no careful comparison of the ‘non-finite’ forms in Malayalam has taken place. Better understanding their distribution and the explanations for it is an interesting question in its own right and the goal of this chapter.

In this chapter, three different types of ‘non-finite’ forms will be examined: infinitives, ‘gerunds’ and Conjunctive Participles, in addition to exploring what has been called ‘finite’ vs ‘non-finite’ negation in section 1. The last two forms and the different negations have been used to argue for a tenseless account. However, the data in this chapter show that they, in fact, are not arguments for such an account. Section 2 show that the non-finite *uka* form generally called an infinitive in the generative literature is more probably the progressive participle (cf. Raja Raja Varma 1917).

Section 3 argues that Conjunctive/Adverbial Participles are structurally small, roughly vPs. It further shows that Conjunctive Participle Constructions/Serial Verb Constructions are semantically underspecified for tense and viewpoint aspect and require the clauses involved to be pragmatically linked either via causation, manner or sequence of events. It suggests that a modified version of a Stump (1985) style approach can account for these facts. The modification is needed because, unlike English absolutes, Malayalam Conjunctive Participles cannot occur with Individual Level Predicates or multiple temporal adverbs. It is suggested that these facts can be explained by the reduced size of Conjunctive Participles.

Section 4 shows that what have traditionally been called ‘gerunds’ (in the sense of an English-style ‘poss-ing’ gerund (Abney 1987)) are actually tensed, relative clauses with number and gender agreement acting as the head noun. Section 5 concludes.

4.1 ‘Finite’ and ‘non-finite’ negation

Commonly, Dravidian languages are viewed as having two types of negation (Asher & Kumari 1997, Amritavalli & Jayaseelan 2005, Amritavalli 2014, a.o.): a ‘finite’ one and a ‘non-finite’ one. The ‘finite’ negation, *illa* in Malayalam, gets its name from the fact that it occurs with main verbs, (1). In infinitival constructions, this negation cannot be used, (2-a). Instead the ‘non-finite’ *aa-* negation must be used, (2-b). This ‘non-finite’ negation cannot be used to negate main verbs, (3).¹

- (1) a. avan var-unn(u)-∅ illa.
He come-IMPFV-PRES NEG
‘He does not come.’
- b. avan vann-(u) illa.
He come-PAST NEG
‘He did not come.’ (Amritavalli & Jayaseelan 2005: 4, p195)
- (2) a. *avan [PRO ninth-uvaan illa] nookk-i.
He swim-INF NEG look-PAST (i.e. tried)
‘He tried not to swim.’
- b. avan [PRO ninth-aa-the irikk-uvaan] nookk-i.
He swim-NEG-AUG irikk-INF look-PAST (i.e. tried)
‘He tried not to swim.’ (Amritavalli & Jayaseelan 2005: 31, 32b, p196)
- (3) a. *avan var-aa(-the)
he come-NEG-AUG
‘He does not come.’
- b. *avan var-aa-th-unnu-∅
he come-NEG-EPENTHETIC-IMPFV-PRES
‘He does not come.’

¹As Jayaseelan (2003) notes, the nature of the augment in (3) is poorly understood. Examples such as (i-a), where *aa-* appears without *the*, show that the negation is just *aa-* not *aathe*.

- (i) a. avann-u jooli kitt-aa-nj-athu albhutam aanu
He-DAT job get-NEG-??-NOMLZ surprise be.PRES
‘It is suprising that he didnt get the job.’ (Asher & Kumari 1997 p16: 74b)
- b. ellaavarum var-aa-th-irunn-aal...
all come-NEG-AUG-irikk-if
‘If no one comes...’ (Mathew 2014 p22: 11-12)

I suspect that the *th-* may be appearing for phonological reasons, i.e. to prevent hiatus. Note that the *e* does not always occur with the *th-*, for example in (i-b).

- c. *avan var-unn(u)-∅-aa(-the)
 he come-IMPV-FV-PRES-NEG-AUG
 ‘He does not come.’

Example (4) shows that the *aa-* verses *illa* distinction cannot be accounted for in terms of *illa* being matrix negation while *aa-* is embedded negation. This example shows that *illa* can occur in embedded clauses.

- (4) [asha raaman-e premikk-unn(u)-∅ illa ennu] unni paranj-u
 Asha Raman-ACC love-IMPV-FV-PRES NEG COMP Unni say-PAST
 ‘Unni said that Asha does not love Raman.’

4.1.1 Problems for a finite based account

In general, ‘finiteness’ is not well understood. It is defined in a variety of ways by different researchers (Nikolaeva 2010, McFadden & Sundaresan 2014, a.o.). For the purpose of describing the negation facts, the Dravidian literature talks in terms of ‘finite’ verses ‘non-finite’ forms. For example, Amritavalli (2014) argues that when the tense morpheme shifts from the lexical verb to the dummy verb *irikk-* ‘sit’, as in (5-b)/(6-b), the lexical verb is demoted to a participle (a ‘non-finite’ form). As such, this participle requires ‘non-finite’ *aa-* negation, while the dummy ‘main/finite’ verb requires ‘finite’ *illa* negation, (6-b). One weakness of this account is that it does not explain why the dummy verb occurs. Example (7) shows that no such verb is needed in the positive counterparts of (5-b)-(6-b).

- (5) a. rajan onnum paranj-illa.
 Rajan nothing said.PAST-NEG
 ‘Rajan said nothing.’
 b. rajan onnum paray-aa-the irunn-u
 Rajan nothing say-NEG-AUG irikk-PAST
 ‘Rajan did not say anything.’ (Mathew 2014 p23: 14-17)
- (6) a. *avan var-unn(u)-∅ illa illa
 he come-IMPV-FV-PRES NEG NEG
 ‘He doesnt not come.’

- b. avan var-aa-the irukk-unn(u)- \emptyset illa
 he come-NEG-AUG irikk-IMPV-PRES NEG
 ‘He doesn’t not come.’ (Amritavalli 2014 p299: 24)
- (7) a. rajan entoo paranj-u
 Rajan something say-PAST
 ‘Rajan said something.’
- b. avan vann-u
 he come-PAST
 ‘He came.’

If the view that finiteness is about clauses not about forms is adopted, then (5-b) shows that *aa-* negation can, in fact, occur in a main ‘finite’ clause just like *illa* can, (5-b). At this point, one might wonder if the negated lexical verb could be constituting its own separate, ‘non-finite’ clause. If this were so, then it might suggest that *aa-* can, in fact, only be used in ‘non-finite’ clauses.

However, a biclausal analysis for the *aa-* negation constructions in (5)-(6) can be ruled out through binding tests. Malayalam has a form *thaan*, which disallows co-argument binding, (8-a).² The antecedent must be either separated from *thaan* by a clause boundary, (8-b), or a PP or DP boundary, (8-c)-(8-d). For co-argument binding, another form, *thanne thanne*, is used, (8-e). Example (9) shows that only *thanne thanne* is allowed when there is *aa-* negation on a main verb. This suggests that the *aa-* negation participle and the dummy verb, *irikk-* ‘sit’, form a single clause.

- (8) a. * anu_i than- $\text{ne}_{i/*j}$ null-i.
 Anu self-ACC pinch-PAST
 ‘ Anu_i pinched herself $_{i/*j}$.’
- b. [unni_j than- $\text{ne}_{i/*j/*k}$ premikk-unn(u)- \emptyset ennu] anu_i paranj-u.
 Unni self-ACC love-IMPV-PRES COMP Anu say-PAST
 ‘ Anu_i said that Unni_j loves {her $_{i/*k}$, *himself $_j$ }.’
- c. anu_i [than- $\text{te}_{i/*j}$ kutti-ye] null-i.
 Anu self-GEN child-ACC pinch-PAST
 ‘ Anu_i pinched her $_{i/*j}$ child.’
- d. anu_i [than- $\text{te}_{i/*j}$ mukalil] oru vimanam kand-u.
 Anu self-GEN above one plane see-PAST

²See Swenson & Marty (under revision) for more details about the behavior of *thaan*.

- ‘Anu_i saw a plane above herself_{i/*j}.’
- e. anu_i than-ne thanne_i null-i.
 Anu self-ACC EMP pinch-PAST
 ‘Anu_i pinched herself_i.’
- (9) a. *avan_i than-ne_{i/*j} adikk-aa-the irunn(-u)
 he self-ACC beat-NEG-AUG irikk-PAST
 ‘He_i didn’t beat himself_{i/*j}.’
- b. avan_i than-ne thanne_i adikk-aa-the irunn(-u)
 he self-ACC EMP beat-NEG-AUG irikk-PAST
 ‘He_i didn’t beat himself_i.’

Such a clausal definition of finiteness seems more fitting if it is assumed that the dummy verb *irikk-* ‘sit’ is functioning as a type of ‘do’ support and that do support occurs when T and the inflectional head with which it agrees are not immediately local (Bjorkman 2011). In other words, if this account is right, ‘do’ support should only occur when something prevents the verb from agreeing with the T head. In the case of (5-b), (6-b), and (9-b) that should be the *aa-* negation.

The presence of this negation would then trigger ‘do’ support. In this system, the dummy verb appears because the presence of negation causes the lexical verb to be unable to agree with T. The negation does not appear because the lexical verb has already been demoted by the presence of the dummy verb, as in Amritavalli’s system. Given that other languages with ‘do’ support that have been studied do not have multiple types of negation like Malayalam, there is, of course, nothing in any of the existing analyses for ‘do’ support that tells what type of negation should occur where. Providing an account for these facts is a task for future work. See chapter 5 section 3 for some further discussion.

The takeaway point for now is the following: example (2) shows that ‘non-finite’ clauses only allow *aa-* negation. However, the examples in (5) show that main verb ‘finite’ clauses can have both *illa* and *aa-* negation, albeit with a slight meaning difference according to Mathew’s translations. Given these facts, ‘finiteness’ does not seem to be the governing factor in determining the use of negation in Malayalam.

4.1.2 Possible alternate analysis

Based on the data and discussion so far, it seems like a new analysis that is not defined in terms of the poorly understood concept of ‘finiteness’ is in order. An alternative approach might rest on *aa-* and *illa* having different scope restrictions. One possibility would be to understand *-aa-* negation as low level negation and *illa* negation as higher level negation. Mathew (2014), in fact, has already argued that *aa-* in Malayalam is not ‘non-finite’ negation, but vP-level negation based on evidence from quantifier scope and NPI licensing. The sentences in (10) show that *illa* scopes over subject quantifiers, while *aa-* scopes under them, (11).

Neg>Subj *Subj>Neg (*illa*>*ellaavarum* **ellaavarum*>*illa*)

- (10) a. *ellaavarum vann-illa*
 all come.PAST-NEG
 ‘Not all came.’
- b. *ellaavarum vann-ill-engil...*
 all come.PAST-NEG-if
 ‘If not all of them come...’

Subj>Neg (*ellaavarum* > *-aa-*)

- (11) *ellaavarum var-aa-th-irunn-aal..*
 all come-NEG-AUG-irikk-PART form-if
 ‘If no one comes..’ (Mathew 2014 p22: 11-12)

These data suggest that the subject is higher than *aa-* but lower than *illa*. This is supported by data from NPIs, such as *aarum* and *onnum*³, where we see that subject and object NPIs are licensed with *illa*, (12) and that object, (14-a), but not subject, (13), NPIs are licensed with *aa-*.

³When the negation is removed, the sentences in (i) are unacceptable, as expected with NPIs.

- (i) a. **aarum uttharam paranj-u.*
 nobody answer say-PAST
 ‘Nobody said the answer.’
- b. **rajan onnum paranj-u.*
 Rajan nothing said-PAST
 ‘Rajan said nothing.’

illa > Subj/Obj NPI

- (12) a. aarum uttharam paranj-illa.
Nobody answer said.PAST-NEG
'Nobody said the answer.'
- b. rajan onnum paranj-illa.
Rajan nothing said.PAST-NEG
'Rajan said nothing.'

*-aa- > Subj NPI

- (13) a. *aarum uttharam paray-aa-th-irunn-u
no.one answer say-NEG-AUG-irikk-PAST
'No one said the answer.'
- b. *uttharam aarum paray-aa-th-irunn-u
answer none say-NEG-AUG-irikk-PAST
'No one said the answer.'

-aa- > Object NPI (in its scope)

- (14) a. rajan onnum paray-aath-irunn-u
Rajan nothing say-NEG-irikk-PAST
'Rajan did not say anything.' (Mathew 2014 p23: 14-17)
- b. *onnum rajan paray-aa-th-irunn-u
nothing Rajan say-NEG-AUG-irikk-PAST
'Rajan did not say anything.' (Madhavan p.c.)

illa > scrambled Obj NPI

- (15) onnum rajan paranj(-u)-illa
nothing Rajan say-PAST-NEG
'Rajan said nothing.' (Madhavan p.c.)

Example (14-b) shows that, with -aa- negation, when an object NPI is scrambled above the subject, the sentence becomes bad, suggesting that the NPI is no longer in the scope of -aa-. However, when *illa* is used, (15), the sentence is good, suggesting that the scrambled object is in the scope of the negation.⁴

⁴Asher & Kumari (1997), Mathew (2014) and Swenson et al. (2015) argue that the sentence

Based on the data in (12)-(14-a) and the fact that *aa-* can only attach directly to verbal roots, Mathew concludes that *aa-* is vP level negation. As such, *-aa-* does not seem to be ‘non-finite’ negation but, rather, simply vP-level negation (which is therefore ‘non-finite’). One advantage of such an analysis is that if the locus of *aa-* negation is a NegP just above the vP, then this would create the type of intervention environment that is predicted to trigger ‘do’ support, as discussed above. Regarding the subject, which the quantifier scope data showed was higher than *aa-*, Mathew concludes that it moves outside of the vP but to a position lower than *illa*. Taking the next natural step, which Mathew does not take, one could investigate the following possibility: if the subject is in Spec/TP, and *illa* is higher than the subject, *illa* selects for something larger than a TP. As such, it could not appear with infinitives because they could not be structurally large enough. Given that finiteness is frequently linked with higher positions such as TP or CP, this could explain why it has been called ‘finite’ negation.

This account would nicely handle the Conjunctive/Adverbial Participle data. These participles will be discussed in detail in section 3, where they will be argued to be vPs. Example (16-a) shows that the ‘finite’ negation, *illa*, cannot be used with Conjunctive/Adverbial Participles. Instead the ‘non-finite’ negation, *-aa-*, is required, (16-b). Note that *aa-* cannot be used by itself with a main verb, (16-d); only *illa* is allowed, (16-c).

- (16) a. *avan onnum paranj-illa pooy-i.
 he anything say.PART -NEG go-PAST
 ‘He left without saying anything.’
- b. avan onnum paray-aa-the pooy-i.
 he anything say-NEG-AUG go-PAST

initial position is a topic position. Assuming anti-symmetry Kayne (1994), Jayaseelan (2001) argues that Malayalam needs a TopP directly above the vP to account for different possible word orders. If Jayaseelan’s account is adopted, and it is assumed that the subject is in Spec/vP, then the object could simply be outside the vP but lower than TP. Alternatively, if it is assumed, following Rizzi (1997), that there are TopPs in the expanded CP-level, then this data could be showing that the object is outside of the TP in a CP-level TopP and that *illa* is located higher than a CP-level TopP. The fact that *illa* can scope over subjects but that the vP-level negation *aa-* cannot suggests that subjects move outside of the vP. This suggests that the second option assuming a CP-level TopP is the right one. If so, this suggests that *illa* is, indeed, very high-level negation.

‘He left without saying anything.’

- c. avan onnum paranj-illa.
he anything say.PAST-NEG
‘He did not say anything.’ (Jayaseelan 2003 p77: 36-38)
- d. *avan onnum paray-aa-(the).
he anything say-NEG-AUG
‘He did not say anything.’

Since Conjunctive/Adverbial Participles are not larger than TPs, it naturally follows that *illa* cannot be used with them and that the vP-level negation *aa-* is required. However, such a story is more difficult with *athu* nominalizations, which have also been argued to be non-finite based on the distribution of negation in them.

- (17) a. *[nii koozha vaang-unn- \emptyset -athu illa] ellaavarum ariy-um
you bribe take-IMPFV-NOMLZ NEG all know-GEN
‘Everyone knows that you do not take bribes.’
- b. [nii koozha vaang-aath-athu] ellaavarum ariy-um
you bribe take-NEG- NOMLZ all know-GEN
‘Everyone knows that you do/did/will not take bribes.’

Section 4 of this chapter provides an argument that *athu* nominalization occurs above TP. One would then have to say that *illa* selects for something larger than this nominalization. While this is possible, how exactly it would be done in a way that is not highly stimulatory is not clear-cut. Another possibility is that this high *illa* only occurs with verbs and that the nominalization occurs before the verb reaches the level where *illa* is.

4.1.3 Interaction of negation and modals

Another problem for the alternate suggestion comes from the future. Unlike in the present and past tenses, there seems to be a co-occurrence restriction on *illa* and the future marker, (18-a). The negation of the future is accomplished by either the *uka* progressive participle plus *illa* or just the verbal root plus *illa*, (18-b)-(18-c).

- (18) a. *John var-um illa
 John come-FUT NEG
 ‘John will not come.’
- b. John var-uka illa
 John come-PROG NEG
 ‘John will not come.’
- c. John var-illa
 John come-NEG
 ‘John will not come.’ (Jayaseelan 2014 p198-199: 18-20)

This pattern depends on the type of verb. In the case of stative verbs, the bare verb stem can also be used for the negation of the present and the future, (19).

- (19) a. enikku ariy-illa.
 I.DAT know-NEG
 ‘I don’t know.’
- b. avar-u nammal-e kand-aal ariy-illa
 they-DAT we(INCL)-ACC see-CONDIT know-NEG
 ‘They won’t know us if they see us.’

This complementary distribution between *um* and *illa* mirrors that of modals, which cannot be negated by *illa* but, instead, have their own negative forms.

- (20) a. enikku veenam
 I.DAT want
 ‘I want (it).’
- b. *enikku veenam-illa
 I.DAT want-NEG
 ‘I don’t want (it).’
- c. enikku veenda
 I.DAT want.NEG
 ‘I don’t want (it).’

Also like modals *-um* can be followed by the past tense form of the copula *aanu* to express past tense, (21). Hany Babu (1997) takes this as an argument that *um* is not a future tense marker but a modal.

- (21) a. poog-aam aayirunnu
 go-MOD be.PAST
 ‘could have gone’
- b. poog-anam aayirunnu
 go-MOD be.PAST
 ‘should have gone’
- c. poog-um aayirunnu
 go-MOD be.PAST
 ‘would have gone’ (Hany Babu 1997 p83: 19)

The alternative account sketched above would not, in any obvious way, explain the co-occurrence restriction between modals and the *illa* negation. Finding an analysis that can account for all the facts is a task for future research. Having discussed this language internal criteria for ‘finiteness’, the thesis will now turn to the more general properties associated with ‘finite’ and ‘non-finite’ forms.

4.2 Non-finite uses of *-uka* marked verbs

The first non-finite form that will be examined in this thesis is that of non-finite uses of *uka*. This morpheme has generally been called the citation infinitive in the generative literature and in Asher & Kumari’s (1997) grammar. However, chapter 3 argued that this morpheme is the progressive viewpoint aspect marker for finite verbs in Malayalam. In both finite and non-finite forms, it seems to be functioning analogously to a progressive participle in English. In fact, Raja Raja Varma (1917) calls this form the mid verbal participle (*natuwinayeccam*). Malayalam has another form, *-(uv)aan* which is often called the ‘purposive infinitive’ in the generative literature because it is the form used in embedded infinitives, such as those in (22). Raja Raja Varma (1917) also calls these *(uv)aan* forms (post verbal) participles.

- (22) a. raaman [bakshnam und-aak-uvaan (*ennu)] thirumaanicch-u.
 Raaman food exist-CAUS-INF COMP decide-PAST
 ‘Raman decided to make food.’
- b. raaman [ood-uvaan] sramicch-u.
 Raman run-INF try-PAST

‘Raman tried to run.’

- c. amma [visakk-aan] aagrahicch-u.
mother hungry-INF want-PAST
‘The mother wanted to be hungry.’ (Menon 2011 p5-7: 8a, 14a,c)

These differences of terms raise an interesting question: what makes something a participle versus an infinitive? Generally, there is agreement that participles and infinitives are both ‘non-finite’ forms, but it is not so clear how non-finite forms differ from one another. It is quite possible that the *uka* form, which is used as the citation form of the verb in Malayalam, may have begun to be called an infinitive simply because the citation form in languages like Latin is the infinitive. This type of comparative label though, does not lead us any closer to understanding the nature of non-finite distinctions cross-linguistically.

Following the arguments in chapter 3 that *-uka* is a progressive viewpoint aspect marker on finite verbs and the facts presented below that show that its non-finite uses also seem to carry some progressive meaning, throughout the thesis it will be glossed as a progressive. However, this should not stop further inquiry into the fundamental question raised above. In order to make a bit of headway towards that larger question, the syntactic environments where non-finite *-uka* constructions can occur will be shown below.

It will be shown that *uka* constructions, while having some properties of nouns, seem to more closely pattern the distribution of adjectives. This is an interesting observation in light of Menon’s (2016) work that argues that Malayalam lacks an adjectival category.

Three environments in colloquial Malayalam where non-finite uses of *uka* can be found are i) in subject position in ‘gerund’ like sentences, (23), ii) in coordination structures, (24), and iii) in certain types of future sentences, (25)-(27). In non-finite situations where *uka* appears, it is directly bound to the verbal stem. In ‘gerund’ like sentences, *-uka* behaves like a nominal, (23-b), on par with *athu* nominalization, (23-a), which is discussed in detail in section 4.

- (23) a. [kallam paray-unn- \emptyset -athu] thet-aanu
 lie say-IMPV-PRES-NOMLZ wrong-be.PRES
 ‘Telling lies is wrong.’
- b. [kallam paray-uka] thet-aanu
 lie say-PROG wrong-be.PRES
 ‘Telling lies is wrong.’ (Asher & Kumari p322: 1591)

The *uka* form also serves a nominal role in coordination. Finite sentences, which have fully verbal verbs, cannot be coordinated in Malayalam, (24-a). Instead the finite verbs are changed to the *-uka* form, the conjunction marker *um* added then the verb *cheyy-* ‘do’ is used as a type of ‘do’ support, (24-b).⁵

- (24) a. *raaman vann-u-yum krishnan pooy-i-yum.
 Raman come-PAST-CONJ Krishnan go-PAST-CONJ
 ‘Raman came and Krishnan went.’
- b. raaman var-uka-yum Krishnan pook-uka-yum cheyth-u
 Raman come-PROG-CONJ Krishnan go-PROG-CONJ do-PAST
 ‘Raman came and Krishnan went.’ (Asher & Kumari 1997 p135: 647c)

A third place that *uka* is used is in the future of sentences with negation, emphatic marking and clefts. In negated and in emphatic future sentences, *-uka* seems to have a more verbal role. Non-stative verbs in Malayalam can use either the *uka* marked form or the bare root form to express future negative sentences, (25-b)-(25-c). In emphatic clauses with a future meaning, *uka* is also used and comes below the emphatic marker and below the form of the *undu* copula carrying the future marker, (26). In clefted structures *uka* appears in the same place that *athu* nominalizations occur, (27), i.e. in a more nominal role.

⁵This verb *cheyy-* frequently appears with nouns, (i) and, in its light verb use, commonly serves to verbalize nouns, (ii).

- (i) johan avan-te jooli cheyth-u
 John he-GEN work do-PAST
 ‘John did his work.’ (Paul 2013 p3: 7)
- (ii) sudha ayaal-e googil cheyth-appool aan-ee...
 Sudha that-man-ACC Google do.PAST-at.that.time be.PRES-EMPH
 ‘It was (only) when Sudha googled that guy, that...’ (Paul 2013 p)

- (25) a. *John var-um illa.
John come-FUT NEG
'John will not come.'
- b. John var-uka illa.
John come-PROG NEG
'John will not come.'
- c. John var-illa.
John come-NEG
'John will not come.' (Jayaseelan 2014 p198-199: 18-20)
- (26) avan var-uka-yee ull-uu.
He come-PROG-EMPH be.RP-FUT
'He will just come.' (Asher & Kumari 1997 p290: 1436)
- (27) a. [nammal eppoozh-aanu chell-uka ennu] avar choodik- \emptyset
we.INCL when-be.PRES go-PROG COMP they ask-IMPV-PRES
'They are asking when [it is] that we will go (there).'
- b. [enth-aanu var-aa-th-athu ennu] njaan choodicch-u
why-be.PRES come-NEG-AUG-NOMLZ COMP I ask-PAST
'I asked why (he) would not come.'

According to Nikolaeva (2010) who cites Haspelmath (1994), participles are most like adjectives in their properties. Despite the mostly nominal like uses above, one could make a case that non-finite uses of *uka* have a syntactic distribution most like adjectives. The rest of this section shows why this case could be made. Throughout, the properties of *uka* participles are contrasted with *athu* nominalizations.

The first reason is that, like adjectives, *-uka* participles cannot have a specifier position, (28-b).

- (28) a. avan/avan-oodu kallam paray-unn- \emptyset -athu thet-aanu.
he/he-SOC lie tell-IMPV-PRES-NOMLZ wrong-be.PRES
'His telling lies is wrong/for him to tell lies is wrong.'
- b. *avan/avan-oodu/avan-te/avan-u kallam paray-uka thet-aanu.
he/he-SOC/he-GEN/he-DAT lie tell-INF wrong-be.PRES
'His telling lies is wrong/for him to tell lies is wrong.'

They also do not assign case to their objects, (29-b), and they cannot appear with

manner adverbs⁶, (30-b).

- (29) a. [kaayal-il kutti-ye neenth-aan anuvadikk-unn- \emptyset -athu] njaan
lake-LOC child-ACC swim-INF let-IMPV-PRES-NOMLZ I
ethirthth-u
oppose-PAST
'I opposed letting the child swim in the lake.'
- b. *[kaayal-il kutti-ye neenth-aan anuvadikk-uka] njaan ethirthth-u
lake-LOC child-ACC swim-INF let-PROG I oppose-PAST
'I opposed letting the child swim in the lake.'
- (30) a. [melle avan kazhikk-unn- \emptyset -athu] aarogyatthi-nnu
slowly he eating-IMPV-PRES-NOMLZ health-DAT
nall-athu aanu
good-NOMLZ be.PRES
'His eating slowly is good for health.'
- b. *[melle avan kazhikk-uka] aarogyatthi-nnu nall-athu aanu
slowly he eating-PROG health-DAT good-NOMLZ be.PRES
'His eating slowly is good for health.'

Some people will occasionally accept *-uka* in embedded subject position, but those speakers prefer *athu* nominalization, (31-a), and do not consistently accept sentences like (31-b).

⁶Manner adverbs can only modify verbs in Malayalam, (i).

- (i) a. melle njaan kulikk-unnu- \emptyset .
slowly I bathe-IMPV-PRES
'I bathe slowly.'
- b. *melle kuli
slowly bath
'slow bath'
- c. melle ull-a kuli
slowly be-REL bath
'slow bath'

They also do not occur with the *al* nominalizer in Malayalam, (ii).

- (ii) [Avan-te melle ull-a bakshanam kazhikk-al] aarogyatthi-nnu nall-athu
he-GEN slowly be-REL food eat-NOMLZ health-DAT good-NOMLZ
aanu
be.PRES
'His slow food eating is good for health.'

- (31) a. [[divaseena niinth-unn- \emptyset -athu] aarogyatth-innu nall-athu
 daily swim-PRES-NOMLZ health-DAT good-NOMLZ
 aanu ennu] njaan vicharicch-u
 be.PRES COMP I think-PAST
 ‘I thought that swimming daily is good for health.’ (cf. Asher & Kumari
 1997 p42: 178)
- b. ??[[divaseena niinth-uka] aarogyatth-innu nall-athu aanu
 daily swim-PROG health-DAT good-NOMLZ be.PRES
 ennu] njaan vicharicch-u
 COMP I think-PAST
 ‘I thought that to swim daily is good for health.’

The only potential case marker that *uka* participles can occur with is the instrumental marker *aal*, (32). An interesting thing to note is that when they are marked with this marker, they allow independent subjects, contrary to their usual behavior, cf. (28-b). Other case markers are not compatible with *-uka* participles/do not allow independent subjects, (32)-(34).

- (32) a. avan paranj-ath-inaal njaan vann-u.
 he say.PAST-NOMLZ-INST I come-PAST
 ‘I came because he told me to.’
- b. avan paray-uk-aal njaan vann-u.
 he say-PROG-INST I come-PAST
 ‘I came because he told me to.’ (Asher & Kumari 1997 p86: 394)
- (33) a. [njaan paranj-ath](-ine) avan ethirtth-u.
 I say-PAST-NOMLZ-ACC he oppose-PAST
 ‘He opposed what I said.’ (Asher & Kumari 1997 p43: 185)
- b. *[njaan paray-uka]-yine avan ethirtth-u.
 I say-PROG-ACC he oppose-PAST
 ‘He opposed what I said.’
- (34) a. [njaan ivide var-unn- \emptyset -ath]-inoodu ayaal-kku viroodham
 I here come-IMPV-PRES-NOMLZ-SOC he-DAT opposition
 undu
 be.PRES
 ‘He is opposed to my coming here.’ (Asher & Kumari 1997 p44: 194)
- b. *[njaan ivide var-uka]-yinoodu ayaal-kku viroodham undu
 I here come-PROG-SOC he-DAT opposition be.PRES

‘He is opposed to my coming here.’

Based on (29)-(35) it does seem that *uka* participles have a number of the same properties that would be expected with adjectives. They also, however, as (22)-(25), (28) show, behave very much like nominals.

Providing an analysis for these facts seems like a productive line for future research given that the adjectival like behavior of *uka* participles is interesting in light of Haspelmath’s (1994) generalization and in light of the fact that Malayalam is a language which is generally argued to have an extremely small set of adjectives (Asher & Kumari 1997) or lacks an adjectival category completely (Menon & Pancheva 2014, Menon 2016).

4.3 Conjunctive/Adverbial Participles

This section focuses on another non-finite form, what is known as Conjunctive/Adverbial Participle. In his typological study of South Asian languages, Subbārāo (2012) generalizes that the term ‘Conjunctive/Adverbial Participle’ refers to a non-finite construction, whose verb is marked with a particular ‘participle’ marker. One of the main uses of the Conjunctive/Adverbial Participle in South Asian languages is in what has been called the Conjunctive/Adverbial Participle Construction. This construction has also been called a Serial Verb Construction (Jayaseelan 2003). This construction contains two clauses: one is a finite matrix clause, and the other clause consists of the Conjunctive or Adverbial Participle. The Conjunctive Participle Clause can be interpreted in a number of ways, such as temporally preceding the finite clause, being temporally simultaneous with the action described by the finite verb, or acting as the cause of the action described by the finite verb. Examples of Conjunctive Participle Constructions with these readings in Malayalam are shown in (35). The Conjunctive Participles, which are italicized, are glossed as PART. Main verbs are bolded.

- (35) a. mani avan-te katha *karanj-u* **paranj-u**.
Mani he-GEN tale cry-PART tell-PAST

‘Weeping, Mani told his tale.’

- b. shaantha kanji *vecch-u* **kudicch-u.**
Shantha rice.porridge make-PART drink-PAST
‘Shantha made rice porridge and drank it.’
- c. kathaku thurakunna shabdham *keett-u* annamma **unarnn-u.**
door opening noise hear-PART Annamma wake.up-PAST
‘Annamma woke up on hearing the sound of the door being opened.’
- (Gopalkrishnan 1985 p17: 3)

The examples in (35) provide a general idea of what Conjunctive/Adverbial Particle(s) (Constructions) are in South Asian languages. However, there is variation with respect to the specific properties of these constructions in one language to another. One interesting fact about Malayalam Conjunctive/Adverbial Participles, as opposed to those in other South Asian languages, is that Conjunctive Participles with no aspectual marking are allowed in Malayalam. The examples in (36) show instances of this. In other languages, such as Bangla, (36-a), Hindi, (36-b), (Indo-Aryan), Gadaba, (36-c), (Austro-Asiatic, Munda), and Kannada, (36-d), and Kurux, (36-e) (Dravidian) (Abbi 1991) the Conjunctive/Adverbial Participle always contains some type of additional marking.

- (36) a. Mary chithi-ta tul-e rakh-lo
Mary letter-CL pick.up-PERFV keep-PAST.3
‘Mary moved the letter and kept it.’ (Basu & Wilbur 2010 p2: 2a)
- b. pitaji khana kha-kur so guye
father food eat-PERF.PART sleep go.3MSG.HON.PAST
‘Having taken his meals the father went off to sleep.’
- c. in-ji
say-PAST.PART
‘having said’
- d. male band-u kere tumbi-tu
rain come-PAST.PART tank fill-PAST
‘The tank filled as a result of rain.’
- e. en nalux nunn-on-ki cail kal-on
1SG work do-FUT.PART walk go-FUT
(Abbi 2012 p9-10)

Since Malayalam allows Conjunctive/Adverbial Participles with no aspect or tense marking, this naturally raises questions about how their temporal semantics are obtained. This in fact is also one reason that their status is so difficult to ascertain. Amritavalli & Jayaseelan (2005) use Conjunctive/Adverbial Participle Constructions to try to argue for a tenseless account of Malayalam. In this section it will be shown that, while Amritavalli & Jayaseelan do generally seem to be right that Conjunctive/Adverbial Participles are structurally small, they are incorrect in arguing that this serves as evidence that Malayalam lacks tense morphology. Instead, this section shows that Malayalam Conjunctive Participles are semantically underspecified for tense and viewpoint aspect and that their temporal interpretations are generally gained via pragmatics.

After providing an overview of the syntactic and pragmatic factors governing the use of this construction, this section points out the similarity of the Malayalam Conjunctive Participle Construction to the English absolute construction. It suggests, following Swenson (2017) that the Stump (1985) based adjunct account proposed in Swenson (2016b), must be modified to capture certain facts about the compatibility of Conjunctive Participles Constructions with Individual Level Predicates and multiple adverbs in Malayalam.

4.3.1 Introducing the puzzle/controversial status

The rest of this section focuses on the question of how Malayalam Conjunctive/Adverbial Participle Constructions/Serial Verb Constructions (what are called in this section ‘multi-verb constructions’) obtain their temporal semantics. Examples (37)-(40) show why the answer to this question is not obvious. In (37) the *-u/i* morpheme looks like the past tense marker on the main verb (bolded).

- (37) a. (innale) njaan pazhum **kazhicch-u**.
 Yesterday I banana take-PAST
 ‘I ate a banana (yesterday).’
- b. (innale) njaan palli-yil **pooy-i**.
 Yesterday I church-LOC go-PAST

‘I went to church (yesterday).’

In sentences like (38-b)-(38-c) the *-u/i* in Conjunctive Participles (italicized) does not seem to encode past semantics. These sentences, respectively, receive a present and future interpretation, despite the fact that the Conjunctive Participle has the *-u/i* marker. This suggests that the *-u/i* marker is, in fact, not a past tense marker. At this point, one might think, as Amritavalli & Jayaseelan (2005) have done, that the *-u/i* is a perfective marker, since Conjunctive Participle event precedes the main event in the sentences in (38), though such temporal precedence is not, in fact, a component of a Klein (1994) style perfective.

- (38) a. *vasantha peena kada-yil pooy-i vaang-i.*
 Vasantha pen shop-LOC go-PART buy-PAST
 ‘Vasantha went to the shop and bought a pen.’ (Gopalkrishnan 1985
 p71: 68a)
- b. *vasantha peena kada-yil pooy-i vaang-unnu-∅.*
 Vasantha pen shop-LOC go-PART buy- IMPFV-PRES
 ‘Vasantha goes to the shop and buys (is going to the shop and buying)
 a pen.’
- c. *vasantha peena kada-yil pooy-i vaang-um.*
 Vasantha pen shop-LOC go-PART buy- FUT
 ‘Vasantha will go to the shop and buy a pen.’

However, as Hany Babu & Madhavan (2003) have pointed out, when sentences like (39) are added to the data set, a perfective analysis of *-u/i* becomes unlikely. In (39) the main verb is in the present tense and the events denoted by the *-u/i* marked Conjunctive Participles occur simultaneously with the event denoted by the main verb.

- (39) *avan padicch-u padippicch-u jooli cheyth-u jeevikk-unnu-∅.*
 he study-PART teach- PART job do-PART
 live-IMPFV-PRES
 ‘He lives studying, teaching and working.’

If the Conjunctive Participle *-u/i* is, in fact, neither a perfective nor a past tense marker, one might consider the option that it is semantically vacuous. This leads to the question, if the *-u/i* in Conjunctive Participles does not have any features associated with it, how are the temporal semantics of multi-verb constructions obtained?

Before discussing this question any further, it is necessary to take a step back and consider an additional reason for the confusion here. A crucial fact in the way Conjunctive Participles are analyzed has to do with the pronunciation/writing of the *-u/i* marker in Conjunctive Participles. In Conjunctive Participle forms ending in *-u*, the *-u* is reduced to a schwa in spoken Malayalam and officially⁷ is written with the schwa marker, *ə*, while the *-u* in past tense main verbs is pronounced as *-u* and written with the *-u* marker, *u*. Raja Raja Varma (1917), Asher & Kumari (1997), Jayaseelan (1984, 2003), Hany Babu & Madhavan (2003) have taken this distinction to indicate that *-u* (pronounced and officially written as a schwa) is a specialized participial marker distinct from the past tense marker.

However, complicating this story is the fact that verbs which use *i* as their non-main verb marker, unlike those using *u*, are not written or said any differently when they are in the main verb or Conjunctive Participle position: the *-i* pronounced as *i* and written the *i* marker, *i*, in both environments. Amritavalli & Jayaseelan (2005), Amritavalli (2014), Jayaseelan (2014), seeing this, seek to answer the question of why the *i* in Conjunctive Participles is identical with the past form of the main verb and thus provide a unified account for both forms. They suggest that a schwa occurs in *u* marked forms as the result of a general vowel reduction process in the language. Pillai (1965) notes that 864 of the 2,881 verbs in his sample use *i*, while 2,017 use *u*, easily making *u* the most common past tense marker. At this point, one might argue that *i*, as the more marked form would be preserved which might explain why it would not be subject to reduction, if Amritavalli & Jayaseelan are right.

It is not always clear though based on speakers' transcriptions/writing whether a *u* or a schwa is being said in the Conjunctive Participle and past tense main verb forms. The impressionistic judgments of the speakers I have consulted suggest that

⁷Though the *-u* marker, *u*, is also found sometimes in colloquial writing.

u is always realized as a schwa in Conjunctive Participles and that the past tense marker *u* is never reduced to a schwa. Shijith S (pc) confirms that, as far as he has generally observed in the spectrograms he has recorded for other purposes, this seems to be the case. Of course, in order to have the final say, an experiment must be done.⁸

In the mean time, this section follows the traditional, more widely accepted analysis that the *u/i* marker in Conjunctive Participles is a specialized participle marking and glosses it as PART. Note that the fact that the form of the Conjunctive Participle parallels that of the past tense form of the main verb is quite similar to what is found in English. Past/perfect participles in English often pattern with the shape of the past tense form of the particular verb. For example, weak/regular verbs often have a past/perfect participle and a past tense form that ends in *ed*, (40)-(41), while strong/irregular verbs often have a past/perfect participle and a past tense form that uses something other than *ed*, (42)-(44).

- (40) a. The dog walked to the park.
b. The dog was walked to the park.
c. The dog has walked to the park.
- (41) a. The boy hummed the song.
b. The song was hummed.
c. The boy has hummed the song.
- (42) a. The fish ate the food.
b. The fish was eaten.
c. The fish has eaten the food.
- (43) a. The boy fed the dog.
b. The dog was fed.
c. The boy has fed the dog.
- (44) a. The boy ran the marathon.

⁸See Appendix B for discussion regarding the choice of *u* versus *i* as the past tense and Conjunctive Participle marker.

- b. The marathon was run by the boy.
- c. The boy has run the marathon.

With the caveat about the pronunciation/written form of Conjunctive Participles out of the way, let us proceed to the next section which details the properties of multi-verb constructions.

4.3.2 Properties of Conjunctive Participle Constructions

Syntactically small

Let us begin with a brief overview of the syntactic properties of multi-verb constructions. Previous work has identified Conjunctive Participles as being non-finite (Jayaseelan 1984, 2003; Amritavalli & Jayaseelan 2005; Hany Babu & Madhavan 2003, Gopalkrishnan 1985), IP or AspP sized adjuncts (Jayaseelan 2003). Evidence that Conjunctive Participle clauses are at least as big as vPs comes from the fact that they can have separate subjects (45).

- (45) [paampu *kadicch-u*] goopi **maricch-u**
 snake bite-PART Goopi die-PAST
 ‘The snake bit (Gopi) and Gopi died.’ (Gopalkrishnan 1985 p55: 41)

The fact that no tense or viewpoint aspect morphemes⁹ can be added to Conjunctive Participles suggests that they are even smaller than (viewpoint) AspP. As Amritavalli & Jayaseelan (2005) point out, the vP negation, *-aa-*, (46-a), but not the higher *illa* negation, (46-b) can be used on Conjunctive Participles.¹⁰This suggests that indeed,

⁹Examples like (39) argue that *u/i* is not a perfective marker itself. The forms *ittu* and *kondu*, which can be added to Conjunctive Participles, and which Asher & Kumari (1997) have called perfective and progressive markers, respectively seem to more accurately be involved in modifying or emphasizing lexical aspect. See chapter 5 for further details.

¹⁰*illa* negation on the main verb can scope over both clauses, (i-a) or just the Conjunctive Participle clause, (i-b).

- (i) a. ente aduttu aarum *vann-u* **irunn-illa**
 I.GEN near anybody come-PART sit.PAST-NEG
 ‘Nobody came and sat near me’ [i.e. neither came nor sat]
 b. innu soobha skuul-il *nadann-u* **pooy-illa**
 today Shobha school-il walk-PART go.PAST-NEG

these Conjunctive Participles are syntactically small. When *-aa-* negation is present it only scopes over the Conjunctive Participle clause, as is expected if it is vP negation.

- (46) a. krishnankutti gauriamma-yude veett-il vaadaka *kodukk-aa-de*
 Krishnankutti Gauriamma-GEN house-LOC rent give-NEG-PART
thaamassicch-u
 live-PAST
 ‘Krishnakutty stayed in Gauriamma’s house without paying rent.’ (Gopalkrishana 1985 p76: 76b)
- b. *krishnankutti gauriamma-yude veett-il vaadaka *kodukk-illa*
 Krishnankutti Gauriamma-GEN house-LOC rent give-NEG
thaamassicch-u
 live-PAST
 ‘Krishnakutty stayed in Gauriamma’s house without paying rent.’

Multi-verb constructions can have different, (47), or same objects, (48).

- (47) njaan [kathi *eduth-u*] appam **muricch-u**
 I knife take-PART bread cut-PAST
 ‘I took the knife and cut the bread.’ (Jayaseelan 2003 p79: 43)

Jayaseelan (2003) provides some reasons for thinking that when there is a shared object it is generated in the VP containing the Conjunctive Participle. First, the shared object can scramble/be generated with the Conjunctive Participle, as shown in (48-a)-(48-b). The Conjunctive Participle can also be scrambled over the subject, leaving the subject behind, (48-c). However, when the shared object occurs in the object position of the main verb, the sentence is ‘more or less unacceptable,’ (49).

- (48) a. njaan [oru maanga] *pootticch-u* **thinn-u**.
 I one mango pluck-PART eat-PAST
 ‘I plucked and ate a mango.’ (Jayaseelan 1984 p624: 1a)
- b. [oru maanga] *pootticch-u* njaan **thinn-u**.
 one mango pluck-PART I eat-PAST
 ‘I plucked and ate a mango.’ (Jayaseelan 2003 p81: 48)

‘Shobha did not go walking to school’ [i.e. Shobha went to school but she did not walk down to it] (Gopalkrishnan 1985 p86-87: 90, 93)

- c. *pootticch-u* njaan [oru maanga] **thinn-u**.
 pluck-PART I one mango eat-PAST
 ‘I plucked and ate a mango.’ (Jayaseelan 1984 p624: 1a”)

- (49) ?*njaan [*pootticch-u*] oru maanga **thinn-u**
 I pluck-PART one mango eat-PAST
 ‘I plucked and ate a mango.’ (Jayaseelan 2003 p81: 47)

While one can see his point, at an intuitive level it seems puzzling why a shared object must be generated in the adjunct, given that adjuncts are optional. In other words, given that (50) is a perfectly grammatical sentence of Malayalam, it is not clear why the addition of the adjunct *pootticch-u* ‘pluck’ in the sentences above should force the now shared object to be generated in the adjunct VP as opposed to simply continuing to be generated the VP of the main verb.

- (50) njaan [oru maanga **thinn-u**]
 I one mango eat-PAST
 ‘I ate a mango.’

Given that multi-verb constructions can share objects, one might argue that these are Serial Verb Constructions (SVCs). However, SVCs also generally have a single negation which takes scope over all verbs (cf. Carstens (2002) for Yoruba and Ijo). This is not the case in Malayalam, as (46-a) shows. Aboh (2009, 2016) further points out that SVCs almost never contain more than one lexical verb; all additional verbs have a functional use. This leads to questions about the exact nature of SVCs and how to differentiate them from things like auxiliaries. See chapter 5 section 4 for further discussion.

Example (51) shows that multi-verb constructions can appear in a variety of places in the sentence, just like the adjuncts in their English translations.¹¹

- (51) a. njaan school-ilekku **nadann-u** [apple *kazhicch-u*].
 I school-to walk-PAST apple take-PART
 ‘I walked to school, eating an apple.’ [school must be reached; apple

¹¹We can be sure what is the Conjunctive Participle versus main verb here because in Conjunctive Participle forms ending in *u*, the *-u* was written with the schwa marker, *u*, while the *u* in past tense main verbs was written with the *u* marker, *u*.

does not have to be eaten (though it could be)]

- b. njaan [apple *kazhicch-u*] school-ilekku **nadann-u**.
I apple take-PART school-to walk-PAST
'I walked, eating an apple, to school.' [school must be reached; apple
does not have to be eaten (though it could be)]
- c. [apple *kazhicch-u*] njaan school-ilekku **nadann-u**.
apple take-PART I school-to walk-PAST
'Eating an apple, I walked to school.' [school must be reached; apple
does not have to be eaten (though it could be)]

Pragmatically licensed

Also like their English absolute counterparts, Malayalam multi-verb constructions require pragmatic licensing conditions. According to Gopalakrishnan (1985), multi-verb constructions presuppose that the Conjunctive Participle is linked to the main verbs via one of the relationships demonstrated in (52): manner adverbial, (a), sequential part of a larger action, (b), and cause and resulting effect, (c).

- (52) a. mani avan-te katha *karanj-u* **paranj-u**.
Mani he-GEN tale cry-PART tell-PAST
'Weeping, Mani told his tale.'
- b. shaantha kanji *vecch-u* **kudicch-u**.
Shantha rice.porridge make-PART drink-PAST
'Shantha made rice porridge and drank it.'
- c. kathaku thurakunna shabdham *keett-u* annamma **unarnn-u**.
door opening noise hear-PART Annamma wake.up-PAST
'Annamma woke up on hearing the sound of the door being opened.'
- (Gopalkrishnan 1985 p18: 8, p52: 37a, p17: 3)

When such a relationship is lacking, she claims that the sentence becomes bad, (52a). Instead to link these two sentences, coordination is required, (52b).

- (53) a. #giita pachakkari *arinj-u* chaaya **und-aakk-i**.
Gita vegetables chop-PART tea exist-CAUS-PAST
'Gita chopped vegetables and made tea.' [doesn't meet criteria] (Gopalkrishnan 1985 p32: 18)

- b. giita [pachakkari ariy-uka-yum] [chaaya und-aakk-uka-yum]
 Gita vegetables chop-INF-CONJ tea exist-CAUS-INF-CONJ
 cheyth-u
 do-PAST
 ‘Gita chopped vegetables and made tea.’

However, if (53-a) is put into the right context, it becomes fine for at least some speakers.

Context: A line in a suspense novel. Gita is a family servant. Her job is to chop the vegetables. After finishing her work, she always makes herself a glass of tea before going.

- (54) ella divasathe poleyum giita pachakkari *arinj-u* chaaya
 every day other Gita vegetables chop-PART tea
und-aakk-i. udane, urakkeyulla shabdham **keett-u.**
 exist-CAUS-PAST suddenly loud noise hear-PAST
 ‘Just like any other day, Gita chopped the vegetables and made tea. Suddenly, she heard a loud noise.’

Another example that illustrates the same point comes from (55). Here there is no obvious connection, outside of a list of future plans, between drinking tea and oiling one’s hair.

Context: You are sitting and talking with a close friend in your hostel after work. You have just been talking about what the plan for the rest of the evening is. She asks if you have had tea yet. You say that you have not. While she asks that question she is oiling her hair. You remember while seeing her do that, that you also need to oil your hair and say so. You know though that she wants to have tea together now so you say...

- (55) chaaya *kudicch-u* oil use **cheyy-um.**
 tea drink-PART oil use do-FUT
 ‘Having had tea, I will oil my hair.’

Another way in which this pragmatic licensing requirement can be seen is in a constraint on when different subjects are allowed in main and non-main clauses. Ac-

According to Gopalkrishnan (1985), different subjects are generally disallowed, except, as in (56), where the subject of the main clause is an argument in the Conjunctive Participle clause.¹²

- (56) a. shaantha kanji *vecch-u* **kudicch-u**
 Shantha rice.porridge make-PART drink-PAST
 ‘Shantha made rice porridge and drank it.’
- b. #[shaantha kanji *vecch-u*] njaan **kudicch-u**
 Shantha rice.porridge make-PART I drink-PAST
 ‘Shantha made rice porridge, and I drank it.’ (Gopalkrishnan 1985 p52: 37)

However, according to my fieldwork, for at least some speakers, (56-b) is fine in a context where I am sick and Shantha is taking care of me and thus makes kanji for me. It is also ok if I visit Shantha’s house and I drink kanji because she made it especially for me or if Shantha brought kanji to the office especially for me, so I should eat it.¹³ The generalization here seems to be that different subjects are allowed only when some type of a connection can be established between the main and non-main clauses.

¹²Some additional examples are provided below. The case of the subject in the Conjunctive Participle clause confirms that it is, in fact, in the main clause subject position due to its case.

- (i) nambiyaar (enikku veendi) offis-il *paranj-u* enikku avide oru jooli **kitt-i**.
 Nambiyar I.DAT for office-LOC speak-PART I.DAT there a job get-PAST
 ‘Nambiar spoke (to them) at the office (for me) and I got a job there.’
- (ii) njaan (shobha-ye) *nirbandhicch-u* shoobha/aval skuul-il **pooy-i**.
 I Shobha-ACC force-PAST Shobha/she school-LOC go-PAST
 ‘I forced (Shobha) (to go to school) and so she/Shobha went to school.’
- (iii) paampu *kadicch-u* goopi **maricch-u**.
 snake bite-PART Goopi die-PAST
 ‘The snake bit (Gopi) and Gopi died.’
- (iv) josef *chavitt-i* ente peena **pott-i**
 Joseph step-PART I.GEN pen break-PAST
 ‘Joseph stepped on my pen and it broke.’ (Gopalkrishnan 1985, p54-55: 39-42)

¹³Though kanji is usually given to sick people, so some other food makes more sense to bring to the office.

Another place where the pragmatic restrictions can be seen is in reduplication. Example (57) shows that Conjunctive Participle forms can be reduplicated for emphasis.

- (57) mani chuttum *nook-i* *nook-i* **nadunn-u**.
 Mani around look-PART look-PART walk-PAST
 ‘Mani walked, looking around’ (intensive) [lit. Mani walked around looking, looking] (Gopalkrishnan 1985 p95: 107b)

Gopalkrishnan (1985) claims that in certain contexts reduplication is not possible due to semantic constraints, (58-b). This is probably due to the fact that, generally, saris do not tear after only one washing. According to my fieldwork (58-b) is acceptable in a context where the speaker is complaining about someone who washed a sari that was supposed to not be washed, and as a result, tore it.

- (58) a. saari nanacch-u nanacch-u kiir-i.
 sari wash-PART wash-PART tear-PAST
 ‘The sari tore due to repeated washing.’
 b. #saari nanacch-u kiir-i.
 sari wash-PART tear-PAST
 ‘The sari tore after washing.’ (Gopalkrishnan 1985 p99: 112)

Temporally underspecified

The next thing to note is that event type and iconicity play key roles in specifying the temporal semantics of multi-verb constructions. Let us first turn to the role of event type. In (59) simultaneous (wake up at the same instant as hearing the noise) and successive interpretations (hear the noise one instant and then wake up the next instant) are possible, if the opening of the door is viewed as an instantaneous event. If a speaker assumes that the door is slowly creaking open, i.e. that hearing the noise is not an instantaneous event, a proper containment interpretation (wake up while hearing the noise) is also possible. This is strong evidence that Conjunctive Participles in Malayalam are semantically underspecified and do not have their own tense or viewpoint aspect. It also provides an additional argument against an account

where *u/i* is a perfective marker.

- (59) [kathaku thurakunna shabdham keett-u] annamma unarnn-u.
door opening noise hear-PART Annamma wake.up-PAST
'Annamma woke up hearing the sound of the door being opened. (Gopalkrishnan 1985 p17: 3)

Iconicity is also important in determining the temporal semantics of multi-verb constructions. The role of iconicity can clearly be seen in cases where a sequential reading is preferred. Here, switching the order of the clauses results in a different temporal interpretation. Gopalkrishnan considers sentences like (60-b) to be semantically infelicitous because, according to Hindu etiquette, one should always bathe before going to a temple. If a speaker assumes that not everyone follows temple etiquette, then there is nothing wrong with (60-b). This is simply an example of the role of world knowledge.

- (60) a. asha raavile *kulicch-u* ambalath-il **pooy-i**.
Asha morning bathe-PART temple-LOC go-PAST
'Having bathed in the morning, Asha went to the temple.'
b. asha raavile ambalath-il *pooy-i* **kulich-u**
Asha morning temple-LOC go-PART bathe-PAST
'Asha went to the temple in the morning and then came home and bathed.' [lit. 'Having gone to the temple in the morning, Asha bathed.']

In sum, this section has shown that non-main verbs are structurally small, roughly vPs and that multi-verb constructions are semantically underspecified for tense and viewpoint aspect and require the clauses involved to be pragmatically linked either via causation, manner or sequence of events.

4.3.3 Conjunctive Participles as modified Stump (1985)-style adjuncts

This section argues against a conjunction account, highlights the similarities between English absolutes and Malayalam multi-verb constructions and suggests that a modified version of Stumps (1985) analysis proposed in Swenson (2016b) is needed to account for the incompatibility of Conjunctive Participles with Individual Level Predicates and multiple temporal adverbs in Malayalam. This section begins with an overview of Stumps account for English absolutes.

Against a coordination analysis

Based on the traditional name for non-main verbs, the Conjunctive Participle, one might attempt to argue for a conjunction account for multi-verb constructions. However, this section will argue that such a move faces a number of problems.

The name Conjunctive/Adverbial Participle comes from the two ways these constructions can be translated, either as participle adjuncts serving an adverbial type function, (60-a), or as conjoined sentences, (56-a). While they are sometimes translated using conjunction, they are different from ‘genuinely’ coordinated sentences in the language. These require the addition of the conjunctive particle, *-um*, (61-a). In order to coordinate two independent sentences, using *um* coordination, one must attach *-um* to the progressive participle, *uka*, of the two verbs. The tense and aspect of the sentence are then encoded by the light verb *cheyy-* ‘do.’ This structure must be used because finite clauses cannot be coordinated in Malayalam by simply adding *um* to each verb, (61-b).

- (61) a. raaman var-uka-yum Krishnan pook-uka-yum cheyth-u.
Raman come-PROG-CONJ Krishnan go-PROG-CONJ **do-PAST**
‘Raman came and Krishnan went.’ (Asher & Kumari 1997 p135: 647c)
- b. *raaman **vann-u**-yum krishnan **pooy-i**-yum.
Raman come-PAST-CONJ Krishnan go-PAST-CONJ
‘Raman came and Krishnan went.’

- c. *raaman *vann-u-yum* krishnan **pooy-i-yum**.
 Raman come-PART-CONJ Krishnan go-PAST-CONJ
 ‘Raman came and Krishnan went.’

Example (61-c) shows that it is not possible to conjoin a Conjunctive Participle and a main verb with *um*. Example (62-b) shows this same fact with a multi-verb construction with a single subject.

- (62) a. shaantha kanji *vecch-u* **kudicch-u**
 Shantha rice.porridge make-PART drink-PAST
 ‘Shantha made rice porridge and drank it.’
- b. shaantha kanji *vecch-um* **kudicch-u-yum**
 Shantha rice.porridge make.PART-CONJ drink-PAST-CONJ
 ‘Shantha made rice porridge and drank it.’

It is possible to coordinate multiple Conjunctive Participles with *um*, though this structure is not generally used, (63). The crucial point though is that it is not possible to coordinate a Conjunctive Participle and a main verb using *um*, (61-c).

- (63) njaan maanga *thinn-um* vellam *kudicch-um* vaayaru
 I mango eat.PART-CONJ water drink.PART-CONJ stomach
niiracch-u.
 fill-PAST
 ‘I filled (my) stomach, eating mangoes and drinking water.’ (Jayaseelan 2014
 fn15)

In addition to not allowing coordination via the *um* particle, there are several other reasons to argue against a syntactic conjunction account for multi-verb constructions. First, as seen above, Conjunctive Participles can appear in many positions in the sentence. If syntactic conjunction were assumed, one would worry about Coordinate Structure Constraint violations. Secondly, a syntactic coordination account might try to say that the different pragmatic relationships could be explained by different syntactic configurations. One could try to draw links with a Ramchand (2008) expanded vP since the projections there deal with relationships similar to those involved in Malayalam multi-verb constructions: causation (InitP), manner (ProcP) and se-

quence (ResultP). However, in addition to it being challenging to workout the details of such an analysis, such an account would transfer a largely pragmatically driven phenomenon to the syntax, which seems undesirable. With these points in mind, what follows takes inspiration from the second traditional name for Conjunctive Participles, the ‘Adverbial Participle’ and suggests that they are more like English absolutes than syntactic coordinations.

Overview of Stump (1985)

The adjuncts Stump deals with are those that express relations such as causation, (64-a), serve as temporal adverbials, (64-b), and conditional clauses, (64-c), a.o.

- (64)
- a. The school is determined to avoid a scandal. The father is equally determined to find somebody to blame. The reader, being more experienced in such things, knows the truth: it was murder. [causation]
 - b. Grabbing a newspaper from a guard, Tom went back out, wiped up the dog shit and deposited it and the days news in a refuse can. [time adverbial]
 - c. Transposed to a trumpet or saxophone, her creations would probably herald a new school.[conditional clause] (Stump 1985 p2: 2-4)

Stump’s general proposal is that these adjuncts, if not serving as an argument of a modal, frequency adverb or generic operator, belong to the same category as Main Tense Adverbs (MTA). He defines MTAs as ‘functors, [that] join with tense to characterize the interval at which some sentence is true. In this role, time adverbs are regarded as denoting functions from properties of time intervals to sets of time intervals... MTA join with temporal abstracts to produce temporal abstracts’ (Stump 1985 p118).¹⁴ Some examples of MTAs include *at that time*, *since noon*, *in the morning*, *when Mary sang*, *before Mary sang*, *after Mary sang*, as well as any adjuncts that are

¹⁴MTA are distinct from time adverbs like *yesterday*, *today*, *tomorrow*, *during the past summer* which may function as ‘the argument of certain expressions...the purpose of such a time adverb is simply to specify a set of time intervals.’ p116

not arguments of modals, frequency adverbs or generic operators.

A key tenant of Stump’s proposal is indeterminacy, which occurs when, in order to assign an interpretation to a sentence, some type of inference is needed because it constitutes part of the truth conditional meaning. Stump uses the sentence in (65) to illustrate this concept. Here ‘Picasso’ could refer to a number of things: a painting by Picasso, a man named Picasso, a postage stamp with Picasso’s picture, etc. However, for (65) to be true, the speaker/hearer must infer that the two ‘Picassos’ are of the same category, i.e. two paintings by Picasso not a painting by Picasso and a man named Picasso.

(65) I saw two Picassos today. (Stump 1985 p305: 12)

The claim is that MTAs (i.e. those adjuncts that are not the arguments of a modal, frequency adverb or generalization operator) are semantically indeterminate with respect to the temporal relationship of the two clauses and relevance of the adjunct clause to the main clause. He models this indeterminacy in the semantics using contextual variables.

The obvious question now is, how is this indeterminacy resolved? Stump proposes that the temporal and relevancy relations in MTAs can be derived using information such as event type (instantaneous versus state of affairs/non-instantaneous), word order/iconicity, world knowledge, and predicate type (Individual Level (ILP) vs State Level (SLP)). The middle two pieces of information are relatively self-explanatory. With respect to event type, there are three possibilities, Table 4.1.

Event Type Combinations	Possible Readings
#1: both verbs describe instantaneous events -	sequential simultaneous
#2: one verb describes instantaneous event & one describes non-instantaneous event	sequential proper containment
#3: both verbs describe non-instantaneous events - -	sequential simultaneous proper containment

Table 4.1: Possible Readings for Different Event Types in Absolutives

The sentence in (66) can have a simultaneous interpretation where ‘John’ notices the smoke at the same instant as having the realization, or it can have a successive interpretation where ‘John’ notices smoke one instant and the next instance has the realization. It cannot, however, have a proper containment interpretation.

(66) Noticing the smoke, John realized Bills house was on fire. (Stump 1985 p319: 40)

Example (67) allows a proper containment interpretation where ‘John’ discovers the box while climbing or a successive interpretation where he discovers the box after arriving at the bottom. It cannot, however, have the simultaneous interpretation of climbing and discovering at same time.

(67) John climbed down the well, discovering a sealed metal box at the bottom. (Stump 1985 p320: 42)

In (68) the singing could occur throughout the interval of walking, a simultaneous interpretation, or the singing could occur at some point during the walking, a proper containment interpretation.

(68) Walking beside the river, John sang. (Stump 1985 p320: 43-44)

The intuition regarding predicate type is that SLPs play an essentially temporal role because they naturally represent short and discrete intervals which pin-pointing a particular time, (69).

(69) a. When John was drunk, he fell down the stairs. [SLP]
b. Crossing the street, he was almost hit by a car. [SLP] (Stump 1985 p308: 17a, p309: 19)

ILPs, on the other hand, describe the essential properties of an individual (dispositions, potentials), (70). These are things upon which assumptions about reasons or causes for an action are built.

- (70) a. Having blue eyes, Jane looks a lot like Mary. [ILP]
 b. His father having been a sailor, John knows all about boats. [ILP]
 (Stump 1985 p308: 18)

Applying Stump’s analysis to Malayalam Conjunctive Participle Constructions

Thinking back to section 3.2, there are a number of parallels that can be drawn between English absolutive constructions and Malayalam non-main verbs: both have pragmatic requirements, can occur in a number of positions in the sentence and are semantically indeterminate with respect to temporality. They also gain their temporal interpretations based on the event type, world knowledge, and iconicity. The sentences in (71)-(68) provide some additional examples of the role of event type and world knowledge in determining the semantics in Malayalam.

The sentence in (71-a)¹⁵ shows that, when one event is instantaneous and the other is non-instantaneous/a state of affairs, either a successive or a proper containment relationship is possible, as expected. World knowledge rules out the otherwise expected proper containment relationship in (71-a).

- (71) a. saari *nanacch-u* **kiir-i**.
 sari wash-PART tear-PAST
 ‘The sari tore after washing.’ (Gopalkrishnan 1985 p99: 112)
- b. njaan oru maanga *pootticch-u* **thinn-u**.
 I one mango pluck-PART eat-PAST
 ‘I plucked and ate a mango.’ (Amritavalli & Jayaseelan 2005 p199: 37a,
 my glosses)

When both events are non-instantaneous, all three interpretations are possible, as predicted, (72).

¹⁵Gopalkrishnan says this sentence is semantically infelicitous. However, according to my consultants, (71-a) is fine when complaining about someone who washed a sari that was supposed to not be washed, and as a result, tore it.

- (72) avan paatu *keett-u* paper **ezhuth-i**.
 he song sing-PART paper write-PAST
 ‘Listening to music, he wrote a paper.’

Turning to the puzzle from section 3.1 about multi-verb constructions with present imperfective, (73-a), or future main verbs, (73-b), Stump’s proposal works with things that are already known about Malayalam to provide an explanation. John (1987) and Hany Babu (1997) have argued that the future maker *-um* is a modal, and some type of operator will be needed to account for the ‘generic’ readings obtained with *unnu*. As such, in (73), the contextual variables in Conjunctive Participle clauses would be bound, not via pragmatic factors as in MTAs, but by the modal and ‘generic’ operators taking scope over them, causing the interpretation of the Conjunctive Participle clause to vary with that of the main clause. Jayaseelan (2003) suggests that Conjunctive Participle clauses adjoin at a structurally low point in main clauses. This intuition seems to be on the right track, in that for the modal and ‘generic’ operators to bind the open variable, in their base position, Conjunctive Participle clauses would need to be low enough to be in the scope of the modal and generic operators, presumably located in the higher functional structure above at least AspP.

- (73) a. njaan oru maanga *pootticch-u* **thinn-unnu-∅**.
 I one mango pluck- PART eat-IMPFV-PRES
 ‘I pluck and eat (or am plucking and eating) a mango.’ (Amritavalli &
 Jayaseelan 2005 p199: 38a, my glosses)
- b. njaan oru maanga *pootticch-u* **thinn-um**.
 I one mango pluck- PART eat-FUT
 ‘I will pluck and eat a mango.’ (Jayaseelan 2003 p68: 2b, my glosses)

However, there are several important areas where Malayalam Conjunctive Participles and English absolutes differ. The first is with Individual Level Predicates. English absolutes are compatible with Individual Level Predicates as well as Stage Level Predicates, (70). However, multi-verb constructions are not, (74-a). Instead, the *athu* nominalization must be used, (74-b).

- (74) a. **thadi-yan aayi, avan orupaadu buddhimutt-i.*
 fat-MASC be-PART he much have.trouble-PAST
 ‘Being a fat man, he had a lot of trouble.’
- b. *thadi-yan aay-athu kondu, avan orupaadu*
 fat-MASC be.PAST-NOMLZ INST he much
buddhimutt-i.
 have.trouble-PAST
 ‘Because he is a fat man, he had a lot of trouble.’

Secondly, sentences with multiple temporal adverbs must use *athu* nominalization. They cannot use a multi-verb construction. The examples in (75)-(73) illustrate this with a number of predicates and temporal adverbs. Note that the different temporal adverbs are fine in English absolutive constructions, as can be seen in the English glosses for these sentences.

- (75) a. **innale gundakal vinu-vine thall-i inu avan maricch-u.*
 Yesterday thugs Vinu-ACC beat-PART today he die-PAST
 ‘The thugs having beaten Vinu yesterday, he died today.’
- b. *innale gundakal vinu-vine thall-iy-athu kondu inu avan*
 Yesterday thugs Vinu-ACC beat-PAST-NOMLZ INST today he
maricch-u.
 die-PAST
 ‘The thugs having beaten Vinu yesterday, he died today.’
- (76) a. **thaamasichu pooy-i avan samaya-thinu eth-aan patti-yilla.*
 late go-PART he time-DAT reach-INF could-NEG
 ‘Having left very late, he didnt arrive on time.’
- b. *thaamasichu poy-athu kondu avan samaya-thinu eth-aan*
 late go.PAST-NOMLZ INST he time-DAT reach-INF
patti-yilla.
 could-NEG
 ‘Having left very late, he didn’t arrive on time.’
- (77) a. **kazhinja kollam avudhi-kku varanasi-yil pooy-i,*
 last year holiday-DAT Varanasi-LOC go-PART
 var-unn-∅-a avudhi-kku unni tirupati-yil
 come-IMPV-PRES-REL holiday-DAT Unni Tirupati-LOC
 sandharshikk-aan **theerumaanicch-u.**
 visit-INF decide-PAST
 ‘Having visited Varanasi on holiday last year, Unni decided to visit Tiru-

pati for the upcoming holiday.’

- b. kazhinja kollam avudhi-kku varanasi-yil **poy**-athu kondu,
 last year holiday-DAT Varanasi-LOC go.PAST-NOMLZ INST
 var-unn- \emptyset -a avudhi-kku unni tirupati-yil
 come-IMPV-PRES-REL holiday-DAT Unni Tirupati-LOC
 sandharshikk-aan **theerumaanicch-u**.
 visit-INF decide-PAST
 ‘Having visited Varanasi on holiday last year, Unni decided to visit Tiru-
 pati for the upcoming holiday.’

Different manner adverbs are, however, allowed, at least sometimes. Jayaseelan (1984) provides the example in (78), which all speakers I have consulted accept. However, when the adverb modifying the Conjunctive Participle is changed from *nallavannam* ‘well’ in (78) to *veegam* ‘quickly’ in (79) speakers report a strange feeling. It is not completely clear to me at this point if they find this sentence ungrammatical or if it is due to a pragmatic constraint in that *veegam* ‘quickly’ often gives a negative connotation, i.e. that it is done hastily and sloppily. This would then contradict with the type of ‘savoring’ reading sometimes induced by *pathukke* ‘slowly.’

- (78) njaan oru maanga nallavannam *muricch-u* pathukke **thinn-u**.
 I one mango well cut-PART slowly eat-PAST
 ‘I cut the mango nicely and ate it slowly.’ (Jayaseelan 1984 p624: 2a)
- (79) */#njaan oru maanga veegam *muricch-u* pathukke **thinn-u**.
 I one mango quickly cut-PART slowly eat-PAST
 ‘I cut the mango quickly and ate it slowly.’

This section has shown that both English absolutes and Malayalam Conjunctive Participles have pragmatic licensing requirements, can occur in a number of positions in the sentence and are semantically indeterminate with respect to temporality and gain their temporal interpretations based on the event type, world knowledge, and iconicity. However, unlike English absolutes, Malayalam Conjunctive Participles cannot occur with Individual Level Predicates or multiple temporal adverbs.¹⁶

¹⁶In addition to these differences, it is worth noting that, while at least some speakers do accept benefactive totally unrelated subjects in multi-verb constructions, it is harder to force these readings than in English absolutes. The general feeling among speakers seems to be that the pragmatic

It is interesting that in both of these cases, when provided with the ungrammatical multi-verb construction, speakers correct the sentence by changing the Conjunctive Participle into an *athu* nominalization. Swenson (2016a) argues that this form is nominalized above TP, which would then account for why this structure is compatible with different temporal adverbs while the Conjunctive Participle is not: there simply is no space for a unique temporal adverbial in Conjunctive Participle clauses because they are syntactically too small, roughly the size of a vP. This analysis fits with the facts presented in section 3.2, namely that no viewpoint aspect or tense marking can be added to Conjunctive Participles, while the vP-negation *aa-*, which attaches directly to verbal roots, can be added.

One might object to this analysis by saying that, while temporal adverbs generally require a 's genitive marker to modify nouns, (80-a), they can sometimes modify nouns without this marker as the English example in (80-b) shows.

- (80) a. Yesterday's/last week's mail was late.
 b. The destruction of the city yesterday/last week/in 2012 was sad.

However, in Malayalam temporal adverbs cannot modify nouns directly, (81-a). Instead either the *-athu* nominalizer, created as will be argued in the next section from the relativizer and number and gender agreement, attaches either directly to the adverb base, (81-b) or a dummy verb appears with a relative participle marker, (81-c). Speakers note that the option in (81-b) is correct but not colloquially used. The option in (81-c) is what is more often used in daily conversations.

- (81) a. *veed-inte innale veezhcha bhayanakam aayirunnu.
 house-GEN yesterday fall horribleness be.PAST
 'The fall of the house yesterday was horrible.'
 b. veed-inte innal-athu veezhcha bhayanakam aayirunnu
 house-GEN yesterday-NOMLZ fall horribleness be.PAST
 'The fall of the house yesterday was horrible.'
 c. veed-inte innale undaayirunn-a veezhcha bhayanakam aayirunnu
 house-GEN yesterday be.PAST-REL fall horribleness be.PAST

restrictions on these constructions are stronger than in English absolutes.

‘The fall of the house yesterday was horrible.’ [lit. ‘The fall which was yesterday of the house was horrible.’]

These facts provide support for the idea that Conjunctive Participles are simply too small to host temporal adverbs. The fact that Individual Level Predicates cannot be used in multi-verb constructions might also be a result of their small size. For example, depictives, which describe the state of a given argument of the verb during the duration of the event the verb denotes, (82-a), are not compatible with Individual Level Predicate adverbial adjuncts, (82-b).

- (82) a. John ate the meat raw.
b. *Intelligent, John uses the elevator.

Depictives are generally assumed to be syntactically small (Williams 1980, Pylkkänen (2008)). Perhaps a further connection between depictives and Malayalam Conjunctive Participles could be made in the future.

4.3.4 Interim summary

This section began with a question regarding the temporal semantics of multi-verb constructions. The first subsection showed that the Conjunctive Participle *u/i* marker is, in fact, neither a perfective nor a past tense marker. This opened the option that it is semantically vacuous. The second subsection showed that Conjunctive Participles are structurally small, roughly vPs, and that multi-verb constructions are semantically underspecified for tense and viewpoint aspect and require the clauses involved to be pragmatically linked either via causation, manner or sequence of events. The third subsection argued for a modified version of a Stump (1985) style approach. It showed that both English absolutes and Malayalam Conjunctive Participles have pragmatic licensing requirements, can occur in a number of positions in the sentence and are semantically indeterminate with respect to temporality and gain their temporal interpretations based on the event type, world knowledge, and iconicity. However, unlike English absolutes, Malayalam Conjunctive Participles cannot occur with In-

dividual Level Predicates or multiple temporal adverbs. It was then proposed that possibly due to the structurally small nature of Malayalam Conjunctive Participles.

The data presented here argue against the tenseless account put forth by Amritavalli & Jayaseelan (2005, et. seq.) where *u/i* is the perfective marker. Amritavalli & Jayaseelan argue that the *u/i* in both Conjunctive Participles and main verbs is a perfective marker. Multi-verb constructions with sequential readings with present or future interpretations have been one piece of evidence for their tenseless account. They argue that since the Conjunctive Participle *u* in these constructions cannot be a past tense marker, given its non-past meaning in these sentences, it is a perfective marker. However, the facts presented in this section, namely that certain multi-verb constructions allow simultaneous readings, proper containment readings or sequential readings, serves as evidence against their account. This suggests, that multi-verb constructions actually are not evidence for Malayalam being tenseless.

While flawed, Amritavalli & Jayaseelan's (2005) account prompts one to ask the larger questions which are the focus of this chapter. Central to their proposal is the notion of 'finiteness.' This notion is generally poorly understood, but generally one could say, however 'finiteness' is defined, that languages have a variety of both 'finite' and 'non-finite' forms. These forms, however, generally differ from each other in a number of ways. This chapter so far has examined non-finite uses of *-uka* along with the uses of Conjunctive Participles in Malayalam. The adverb and Individual Level Predicate data provided in this section highlighted a difference between the Conjunctive Participles and *athu* nominalizations. The first section also highlighted some differences between non-finite uses of *-uka* and *-athu* nominalizations. An in depth investigation of *athu* nominalizations will be the focus of the next section.

verb on the ‘inside’ but a noun on the ‘outside.’ One of the reasons that Abney argues that the nominalization occurs above the VP for ‘poss-ing’ gerunds is that there must be a VP with a V to assign accusative case to the object of the gerund and for there to be adverbial modification. One of the arguments that nominalization occurs before TP involves the case of the subject. In a simple sentence like the one in (87-a), the subject receives nominative case from T. In the gerund in (87-b), however, the subject gets genitive case and cannot have nominative case, (87-c). An explanation for this set of facts is that there is no T to license the nominative case for the subject in gerunds.

- (87) a. He met her.
 b. His meeting her...
 c. *He meeting her...

Another reason that this analysis seems plausible is that gerunds are not inflected for tense, which is assumed to be located in T. Evidence for this can be seen in (88) where gerunds are compatible with past, present and future oriented adverbs. Note that the gerund form stays the same here, i.e. there is no morphological change to match the changing temporal interpretation.

- (88) a. his meeting her yesterday...
 b. his meeting her today...
 c. his meeting her tomorrow...

The constructions in (83), like English ‘poss-ing’ and ‘acc-ing’ gerunds, have properties of both verbs and nouns. Specifically, like verbs, they case mark their objects with accusative case, (89-a), and are modified by adverbs, (89-b).¹⁷

¹⁷Malayalam verbs assign accusative case to their objects, (i-a). Nouns, on the other hand, cannot assign accusative case to their object: the object of the noun in (i-b) is marked with genitive case and not accusative case, (i-c).

- (i) a. anu nithin-e null-i.
 Anu nithin-ACC pinch-PAST
 ‘Anu pinched Nithin.’

- (89) a. *vinu asha-ye kaandumutt-unn-∅-athu...*
 Vinu Asha-ACC meet- IMPFV-PRES-NOMLZ
 ‘Vinu’s meeting Asha...’
- b. *melle avan kadhikk-unn-∅-athu...*
 slowly he eating- IMPFV-PRES-NOMLZ
 ‘His eating slowly...’

They also look nominal in that they can be case marked themselves, (90-a), and can appear in the subject position of an embedded clause, (90-b).

- (90) a. [*njaan paranj-ath*]-ine avan ethirtth-u
 I say-PAST-NOMLZ-ACC he oppose-PAST
 ‘He opposed what I said.’ (Asher & Kumari 1997 p43: 185)
- b. [*divaseena ninth-unn-∅-athu aarogyatth-innu nall-athu*
 daily swim- IMPFV-PRES-NOMLZ health-DAT
aanu ennu] *njaan vicharicch-u*
 good-NOMLZ be.PRES COMP I think-PAST
 ‘I thought that swimming daily is good for the health.’ (cf. Asher & Kumari 1997 p42: 178)

While, at first glance, *-athu* constructions might look like English gerunds, the data

-
- b. *nakarat-inte naasam*
 city-GEN destruction
 ‘destruction of the city’
- c. **nakarat-inte naasam*
 city-ACC destruction
 ‘destruction of the city’
- d. *kodumkatt-inaal nakarat-inu/*nakarat-inte naasam*
 storm-INST city-DAT/city-GEN destruction
 ‘destruction of the city by the storm’

Malayalam verbs can also be modified by adverbs, (ii-a), while nouns cannot be, (ii-b). Instead they are modified by adjectives, (ii-c).

- (ii) a. *melle njaan kulikk-unnu-∅.*
 slowly I bathe-IMPFV-PRES
 ‘I bathe slowly.’
- b. **melle kuli*
 slowly bath
 ‘slow bath’
- c. *melle ull-a kuli*
 slowly be-REL bath
 ‘slow bath’

above present two challenges. First, examples (83),(i-a), (89) and (90) show that these constructions, unlike those in English, license a nominative subject not a genitive one as in ‘poss-ing’ gerunds or the accusative found in ‘acc-ing’ gerunds. Secondly, all of the Malayalam *-athu* constructions, tense morphology is appearing, which is also different from both types of English gerunds.¹⁸ This suggests that a different account than those proposed by Abney for English gerunds for Malayalam *-athu* constructions is needed. English gerunds have been argued to be nominalized before TP since they lack tense morphology and cannot be marked with nominative case. By the same logic, it is possible to argue that Malayalam gerunds do, in fact, have a TP present in the syntax since they have both tense morphology and nominative subjects. If this is so, then it is possible to say that nominalization takes place somewhere after, not before, the TP.

There is precedent for such a move in work by Borsley & Kornfilt (2000) and Baker (2011). The basic idea present here is that, given the expansion of functional categories assumed in the current literature, nominalization should, in principle, be able to occur at the level of any of these functional projections. In other words, there are now many more sites in the functional structure where a nominal head could be substituted for its verbal counterpart, i.e. for nominalization to occur. Baker (2011) investigates the Turkish language Sakha and finds that it has something that looks like an English ‘poss-ing’ gerund, as well as another type of construction that is ‘more verbal’ than an English gerund construction, yet still has more nominal properties than an embedded finite clause. He argues that this construction involves nominalization at the CP-level. The next section will present arguments that nominalizations like those in Malayalam *-athu* constructions also occur at the CP-level. The main evidence for this hypothesis comes from a comparison with the behavior of relative

¹⁸There is a difference in that nominative, not accusative, is the default case in Malayalam.

- (i) njaan viroopay-oo?
 I ugly-Q
 ‘Me ugly!’

It is possible that the subjects in *-athu* constructions simply receive default case; however, the same explanation cannot explain away the presence of tense morphology in these constructions.

clauses in Malayalam.

4.4.2 Comparison of Malayalam nominalizations & relative clauses

This section begins with a summary of some basic facts about Malayalam relative clauses. There are two types of relative clauses in Malayalam. The first type is formed by suffixing the relativizer morpheme *a* to the end of the verbal complex. This can simply be a tense suffix as in (91-a)-(91-b) or a modal suffix like the debitive, (91-c). The relative clause precedes the head noun. This construction will be referred to here as a ‘type I’ relative clause.

- (91) a. [joon kan-unn- \emptyset -a] kutti
 John see-IMPV-PRES-REL child
 ‘The child whom John sees’ (Mathew 2007, p227: 1)
- b. [joon kand-a] kutti
 John see.PAST-REL child
 ‘The child whom John saw.’
- c. [kaan-eend-a] kaazhcha-kal
 see-DEB-REL sight-PL
 ‘sights that (one) should see’ (Asher & Kumari 1997, p327: 1619)

In the second type of relative clause, there is no head noun that the relative clause modifies. Instead, an agreement suffix for number and gender is added directly to the relativizer, (92).^{19,20,21} These relative clauses, instead of providing additional infor-

¹⁹Third person pronouns (*avan* ‘he’, *aval* ‘she’, *avar* ‘they’, *athu* ‘it’) in Malayalam are created from distal/proximal markers plus the number and gender agreement morphemes (Mathew 2007, p232: fn4). Menon (2013) says that REL *a* is also derived from the proto-Dravidian distal marker *aa*.

²⁰Past tense forms can also have this done to them: i.e. *vann-a-van* ‘the person (MASC) who came’ etc.

²¹According to Asher & Kumari the neuter form is commonly also used to refer to human beings and provide the example in (i). However, this is a clefted question and so may not be the best example, as examples further own suggest.

- (i) aa var-unn- \emptyset -a-thu aaru aanu
 that come-IMPV-PRES-REL-SG.NEUT who be.PRES
 ‘Who is that person who is coming?’ (Asher & Kumari 1997, p328: 1624)

mation about a particular noun, provide more general information about ‘whoever’ is doing the action. These constructions will be referred to as ‘type II’ relative clauses.

- (92)
- a. var-unn- \emptyset -a-van
come-IMPFV-PRES-REL-SG.MASC
‘the person (MASC) who is coming’
 - b. var-unn- \emptyset -a-val
come-IMPFV-PRES-REL-SG.FEM
‘the person (FEM) who is coming’
 - c. var-unn- \emptyset -a-var
come-IMPFV-PRES-REL-PL
‘the people who is coming’
 - d. var-unn- \emptyset -a-thu
come-IMPFV-PRES-REL-SG.NEUT
‘the person who is coming’ (Asher & Kumari 1997, p328)

The critical point to note is that the form in (92-d) looks identical to the *-athu* form seen above. Based on this similarity, one can hypothesize that the *athu* morphology that was previously glossed as a nominalizer is in fact the relativizer plus number and person agreement.

Mathew (2007) argues that the relativizer morpheme, *-a*, has interpretable, unvalued phi-features based on the fact that it must always occur with either a head noun or an agreement suffix, (93). She takes this to mean that there is, in fact, only one type of relative clause and, in type II relative clauses, the agreement morpheme is playing the same role as the head noun in type I relative clauses.

- (93)
- a. kan-unn- \emptyset -a kutti
see-IMPFV-PRES-REL child
‘the child who sees’
 - b. kan-unn- \emptyset -a-van
see-IMPFV-PRES-REL-MASC.SG
‘one (MASC) who sees’
 - c. kan-unn- \emptyset -PRES-a *(kutti)
see-IMPFV-REL child
(Mathew 2007, p230:9)

- b. [newspaper konduvar-unn- \emptyset -a-thu] nann-aayi.
 newspaper bring-IMPV-PRES-REL-NEUT.SG good-is
 ‘Bringing the newspaper is good.’
- (96) a. [(vinu) asha-ye sneehikk-unn- \emptyset -a-thu] njaan
 Vinu Asha-ACC love-IMPV-PRES-REL-NEUT.SG I
 ethirthth-u.
 oppose-PAST
 ‘I opposed Vinu’s loving Asha.’
- b. [(**vinu*) asha-ye sneehikk-unn- \emptyset -a-van]-e njaan
 Vinu Asha-ACC love-IMPV-PRES-REL-MASC.SG-ACC I
 ethirthth-u.
 oppose-PAST
 ‘I opposed the person who loves Asha loving Asha.’ #‘I opposed Vinu’s
 loving Asha.’
- (97) a. Vinu [newspaper konduvar-unn- \emptyset -a-van]-e
 Vinu newspaper bring-IMPV-PRES-REL-MASC.SG-ACC
 adikk-um.
 beat-FUT
 ‘Vinu will beat the guy bringing the newspaper.’
- b. **Vinu* [newspaper konduvar-unn- \emptyset -a-thu]-e
 Vinu newspaper bring-IMPV-PRES-REL-NEUT.SG-ACC
 adikk-um.
 beat-FUT
 ‘Vinu will beat the person bringing the newspaper.’

The sentences in (98)-(99)²³ show the same pattern holds when nominalized clauses are in indirect object position: the agreement ending matches the type of pronoun that could be substituted for the clause.

- (98) a. njaan [avan var-unn- \emptyset -a-thu] calendar-il
 I he come-IMPV-PRES-REL-NEUT.SG calendar-LOC
 ezhuth-i.
 write-PAST
 ‘I put his coming on the calendar.’
- b. **njaan* [(avan) var-unn- \emptyset -a-van] calendar-il
 I he come-IMPV-PRES-REL-MASC.SG calendar-LOC

²³Since the dative ending and the neuter singular ending are the same its difficult to say if the *-athu* clause is case marking or not in (99-b).

type I and type II relative clauses, as well as the ‘nominalizer’ morpheme attach to the null present tense morpheme that goes with the imperfective aspect morpheme when no tense auxiliary is there.

- (102) a. joon kan-unn- \emptyset -a kutti
 John see-IMPV-FV-PRES-REL child
 ‘The child whom John sees’ (Mathew 2007, p227, 1)
- b. var-unn- \emptyset -a-van
 come-IMPV-FV-PRES-REL-SG.MASC
 ‘the person (MASC) who is coming’
- c. [nii koozha vaang-unn- \emptyset -a-thu] ellaavarum
 you bribe take-IMPV-FV-PRES-REL-NEUT.SG all
 ariy-um
 know-FUT
 ‘Everyone knows that you take bribes.’

The data in (103) shows us that the relativizer in both types of relative clauses and the ‘nominalizer’ morpheme attach to past tense verbs.

- (103) a. joon kand-a kutti
 John see.PAST-REL child
 ‘The child whom John saw’
- b. vann-a-van
 come.PAST-REL-SG.MASC
 ‘the person (MASC) who came’
- c. [nii koozha vaang-iy-a-thu] ellaavarum ariy-um
 you bribe take-PAST- REL-NEUT.SG all know-FUT
 ‘Everyone knows that you took bribes.’ (Asher & Kumari 1997, p51:
 239)

The relativizer cannot attach to the future morpheme in either type of relative clause. The same facts hold for the ‘nominalizer’ morpheme.

- (104) a. *[njaan kaan-um-a] kutti
 I see-FUT-REL child
 ‘(the) child that I will see’(Jayaseelan 2014: 9, p195)

- b. *var-um-a-van
 come-FUT-REL-MASC.SG
 ‘the one who is coming’
- c. *[nii koozha vaang-um-a-thu] ellaavarum ariy-um
 you bribe take-FUT- REL-NEUT.SG all know-FUT
 ‘Everyone knows that you will take bribes.’

Instead, the periphrastic future composed from the infinitive plus the present tense of the verb *pook-* ‘go’ must be used in both types of relative clauses and in the ‘nominalized’ form, (105).

- (105) a. john kan-aan pook-unn- \emptyset -a kutti
 John see-INF go-IMPV-PRES-REL child
 ‘(the) child John is going to see’
- b. var-aan pook-unnu- \emptyset -a-van
 come-INF go-IMPV-PRES-REL-MASC.SG
 ‘The one who is going to come.’
- c. [nii koozha vaangaan pook-unn- \emptyset -a-thu] ellaavarum
 you bribe take-INF go-IMPV-PRES-REL-NEUT.SG all
 ariy-um.
 know-FUT
 ‘Everyone knows that you are going to take bribes.’

Turning now to negation, example (106) shows that neither type I nor II relative clauses nor the ‘nominalizer’ can be used with the *illa* form of negation.

- (106) a. *njaan kand-a illa kutti.
 I see.PAST-REL NEG child
 ‘the child that I didn’t see’ (Jayaseelan 2014: 23, p200)
- b. *van-a-van illa
 come.PAST-REL-MASC.SG NEG
 ‘the one who did not come’
- c. *[nii koozha vaang-unn- \emptyset -a-thu] illa] ellaavarum
 you bribe take-IMPV-PRES-REL-NEUT.SG NEG all
 ariy-um
 know-FUT
 ‘Everyone knows that you do not take bribes.’

Instead, the *aa-* negation must be used in both type I and II relative clauses and ‘nominalized’ forms, (107).

- (107) a. *njaan kan-aatth-a kutti.*
 I see-NEG-REL child
 ‘the child that I don’t/didn’t/will not see’
- b. *var-aatth-a-van*
 come-NEG-REL-MASC.SG
 ‘the one who is/was/will not (be) coming.’
- c. [*nii koozha vaang-aath-a-thu*] *ellaavarum ariy-um*
 you bribe take-NEG- REL-NEUT.SG all know-FUT
 ‘Everyone knows that you do/did/will not take bribes.’

This identical pattern with respect to tense and negation suggests that what have been called ‘nominalized’ clauses are in fact simply relative clauses. Here two possible assumptions could be made: either these constructions could be headless relative clauses where the relativizer *a* spells out a C head, or they could simply involve adding a pronominal form which acts as a high-level nominalizer that nominalizes clauses at a level higher than the TP. This section has presented arguments in favor of bifurcating the ‘nominalizer’ morpheme in Malayalam into the relative marker and an agreement suffix using evidence from agreement, morphological shape and tense and negation. As such, it concludes that *-athu* constructions are actually a type of relative clause, where nominalization happens at the CP-level. Such a conclusion is not unexpected given that nominalization should be able to occur at any of the increased number of functional projections now assumed. The next section will provide language internal evidence from adjectives that Malayalam uses relative clauses for more purposes than English does.

4.4.3 Adjectives as relative clauses in Malayalam

Anandan (1985), Hany Babu (1997), Mathew (2007), Menon & Pancheva (2014), Menon (2016), a.o. have pointed out that most, if not all, adjectives in Malayalam are types of relative clauses. In this way, the use of relative clause structure

for purposes beyond English-style relative clauses seems to be a general property of Malayalam. This section highlights some similarities between adjectives, relative clauses and nominalized clauses. For instance, relative clauses in Malayalam must be followed by a noun or have an agreement morpheme attached to the relativizer, as discussed above. Example (108) shows that adjectives follow the same pattern. If the head noun follows the adjective, no agreement suffix is required, (108-a). However, if the noun being modified precedes the adjective or is absent an agreement suffix is required or the phrase is ungrammatical,(108-b)-(108-f).

- (108) a. idu valiy-a miin aanu
 this big-REL fish be.PRES
 ‘this is a big fish’
- b. miin valiy-a-thu aanu
 fish big-REL-NEUT.SG be.PRES
 ‘fish is big’
- c. vinu valiy-a-van aanu
 Vinu big-REL-MASC.SG be.PRES
 ‘Vinu is big’
- d. *miin valiy-a aanu
 fish big-REL be.PRES
 ‘fish is big’ (Mathew 2007, p231: 13)
- e. *valiy-a aanu
 big-REL be.PRES
 ‘It is big.’
- f. valiy-a-thu aanu
 big-REL-MASC.SG be.PRES
 ‘It is big.’

Observe that the *-athu* constructions in Malayalam do not have any noun following them that they are modifying. This explains why they must have an agreement suffix, (109-b). Notice that in the English translation the word ‘what’ is used. However, no such word is present in the Malayalam sentence in (109-a). Instead, it is the agreement that is playing this roll in Malayalam.

ticiple *u/i* marker is, in fact, neither a perfective nor a past tense marker. This opened the option that it is semantically vacuous. The following section explored the plausibility of this option. It showed that Conjunctive Participles are structurally small, roughly vPs, and that multi-verb constructions are semantically underspecified for tense and viewpoint aspect and require the clauses involved to be pragmatically linked either via causation, manner or sequence of events. The third section argued instead for a modified version of a Stump (1985) style approach. It showed that both English absolutes and Malayalam Conjunctive Participles have pragmatic licensing requirements, can occur in a number of positions in the sentence and are semantically indeterminate with respect to temporality and gain their temporal interpretations based on the event type, world knowledge, and iconicity. However, unlike English absolutes, Malayalam Conjunctive Participles cannot occur with Individual Level Predicates or multiple temporal adverbs. It was then proposed that possibly this is because Malayalam Conjunctive Participles are structurally small.

The data presented here further argued against the tenseless account put forth by Amritavalli & Jayaseelan (2005, et. seq.) where *u/i* is the perfective marker. Amritavalli and Jayaseelan argue that the *u/i* in both main verbs and in Conjunctive Participles is a perfective marker. Multi-verb constructions with sequential readings with present or future interpretations have been one piece of evidence for their tenseless account. They argue that since the Conjunctive Participle *u/i* in these constructions cannot be a past tense marker, given its non-past meaning in these sentences, it is a perfective marker. However, it was shown in this chapter that a given sentence using this construction actually allows simultaneous readings, proper containment readings and sequential readings. This serves as evidence against Amritavalli and Jayaseelan's account, strongly suggesting that these constructions actually are not evidence for Malayalam being tenseless.

The next non-finite form examined, the *athu* nominalization, which has also been used by Amritavalli and Jayaseelan to argue for a tenseless account for Malayalam. Just looking at the similarities between *athu* nominalizations and English 'poss-ing' gerunds, one might be tempted to say that they are analog versions of each other.

However, unlike, ‘poss-ing’ gerunds, *-athu* nominalizations license a nominative subject not a genitive one. Secondly, in all of the Malayalam gerunds, tense morphology is appearing, which is also different from English gerunds. Amritavalli and Jayaseelan interpret this last fact as signaling that this morphology is not actually tense but rather aspect, since English ‘poss-ing’ gerunds cannot contain tense morphology.

However, following the arguments in chapter 3 that Malayalam does have tense morphology/both [PRES] and [PAST] features in the syntax, the data in this chapter suggests that a different account for Malayalam *-athu* ‘gerunds’ is needed than what was proposed by Abney (1987). Specifically, English gerunds have been argued to be nominalized before TP since they lack tense morphology and cannot be marked with nominative case. By the same logic, it has been argued in this chapter that Malayalam *-athu* ‘gerunds’ do, in fact, have a TP present in the syntax and that nominalization simply takes place somewhere after, not before, the TP (cf. Borsley & Kornfilt 2000, Baker 2011). The main evidence for this hypothesis came from similarities between *athu* nominalizations and relative clauses. Since nominalization is possible above TP, Amritavalli and Jayaseelan’s ‘embarrassment’ of having tense morphology present in a gerund is no longer a problem and is, thus, not an argument against Malayalam having tense morphology or a TP.

While flawed, Amritavalli & Jayaseelan’s (2005) account raised many important questions about ‘finiteness.’ This notion is generally poorly understood, but generally one could say, however ‘finiteness’ is defined, that languages have a variety of both ‘finite’ and ‘non-finite’ forms. The adverb and Individual Level Predicate data provided in this paper highlighted a difference between the various ‘non-finite’ forms in Malayalam: Conjunctive/Adverbial Participles and *athu* nominalizations and non-finite uses of *-uka* and the *-athu* nominalizations. Work by Abney (1987) and Stump (1985), a.o. has improved our understanding of different ‘non-finite’ forms in English. This chapter has used those accounts as a spring board for accounting for ‘non-finite’ forms in Malayalam and outlined some of the open questions and challenges that remain to be solved.

Chapter 5

The Perfect in Malayalam

The focus of this chapter will be the composition of the perfect in Malayalam. The chapter will focus primarily on the Universal perfect, but will also examine the Existential perfect. Expressing the perfect in Malayalam requires a syntheses of almost all of the moving parts explored in this dissertation so far, plus some additional ones. As such, this chapter begins with a quick survey of the major relevant findings so far. Chapter 3 argued that Malayalam is a tensed language whose sentences have TPs and AspPs which can have [PRES], [PAST], [FUT/MOD], and [PROG], [IMPFV] features respectively in their heads. The Vocabulary Insertion rules for these features are giving in (1-a)-(1-e).

Vocabulary Insertion Rules (Version 3)

- (1) a. $-\emptyset \leftrightarrow [\text{PRES}]$
- b. $-um \leftrightarrow [\text{FUT/MOD}]$
- c. $-u/i \leftrightarrow [\text{PAST}]$
- d. $-unnu \leftrightarrow [\text{'IMPFV'}]$ (see chapter 3 for details)
- e. $-uka \leftrightarrow [\text{PROG}]$
- f. $undu \leftrightarrow \exists$ copula (also carries an immediacy requirement with location, psychological and medical predicates)
- g. $aanu \leftrightarrow$ elsewhere copula

The progressive morpheme *uka* has an intensional entry, as in many other languages, (2). This chapter will mainly focus on verbs with the progressive, for reasons discussed at the end of the chapter.

- (2) $\lambda w.\lambda t.\lambda P_{\langle s,\langle v,t \rangle \rangle}.\forall w'[w \text{ INERT}_t w' \rightarrow \exists t'[t \text{ is a non-final part of } t' \ \& \ \exists e[\tau(e) \subseteq t' \ \& \ P(w')(e)]]]$ (Beck & von Stechow 2015, cf. Dowty, 1979)

Chapter 3 also argued that *undu* is the existential copula which is also used to express possession. When it is used in location, psychological and medical predicates, it carries an immediacy requirement (cf. Patel-Grosz's (2016) immediacy requirement in certain negative imperatives cross-linguistically), (1-f). The verb *aanu* was argued to be the elsewhere copula, (1-g). Chapter 4 argued that the **Conjunctive Participle** is syntactically small, the size of a vP and semantically underspecified for tense and aspect. This summarizes the parts that have been examined so far.

In exploring the perfect, it is necessary to introduce two new pieces:

- (3) a. non-lexical uses of the verb *irikk-* ('sit')
 b. the functional morpheme *kondu*

This chapter will argue that *irikk-* never functions as a perfect marker (contra Asher & Kumari 1997) in either Universal or Existential constructions. Instead, it has three non-lexical, non-perfect uses: viewpoint aspect auxiliary, light verb (in the sense of Butt (2010)) and 'do' support. It will also show that the function of *kondu* is to make accomplishment predicates (what *kondu* selects for) into activity predicates (which have the subinterval property) and that (unmarked) uses of the Universal perfect in Malayalam require that predicates obtain the subinterval property via their lexical aspect, not through viewpoint aspect alone. Throughout this thesis *kondu* is glossed as LAM for Lexical Aspect Modifier. The main conclusion of this chapter will be that Malayalam does not have PerfP in its syntax or any dedicated perfect morphology.

This chapter will begin with an overview of puzzle parsing the Universal perfect presents. Section 2 examines the nature of *kondu* and what it is required in Universal

perfects. Section 3 examines the role of *irikk-* in Universal perfects, what have been translated as Existential perfects by Asher & Kumari (1997) and ‘do’-support cases. Section 4 concludes.

5.1 Introducing the puzzle

I will begin the discussion with the Universal (U) Perfect. As detailed in chapter 2, the semantics for the U perfect assumed in this chapter are those presented in Iatridou et. al. (2003), where the function of the perfect is to set up a time span called the Perfect Time Span (PTS). The left boundary (LB) of this time span is set by an adverbial (*since 1990, for 1 week, etc.*) or by the context (for example, the speaker’s birth). The right boundary (RB) of the time span is set by tense, as in (4) for the present. Example (4-a) is the most natural way to answer the question ‘What have you been doing lately?’. The RB is also set by tense in past and future perfect sentences in Malayalam, as (5)-(6) respectively show. The U perfect gets this name because it requires that an event holds throughout the PTS (i.e. that there be universal quantification over points in the time span.).

- (4) a. njaan oru aazhcha aayi ii paper ezhuth-i-kkond-irikk-uka(y)-aanu
 I one week ADV this paper have.been.writing
 ‘I have been writing this paper for one week.’

LB _____ **RB**
a week ago.....writing the paper.....UT

- b.
- (5) a. njaan avan-e chovvazhcha kand-u. aa samayathe, avan oru
 I he-ACC Tuesday see-PAST that time he one
 aazhacha aayi aa paper ezhuth-i-kkond-irikk-uka(y)-aayirunnu.
 week ADV that paper had.been.writing
 ‘I saw him last Tuesday. At that point, he had been writing the paper for
 a week.’

. LB _____ RB _____ |
 Tues.....writing the paper.....Tues UT

b.

- (6) a. vyaazhazhcha aak-umbol, njaan ii paper oru aazcha aayi
 thursday be-as.it.becomes I this paper a week ADV
 ezhuth-i-kkond-irikk-uka(y)-aayirikkum
 will.have.been.writing
 ‘On Thursday, I will have been writing this paper for a week.’

. LB _____ | _____ RB
 Thurs.....writing the paper.....UT.....Thurs

b.

Asher & Kumari (1997) gloss the morpheme, *irikk-*, as a perfect marker, used in both the Universal and Existential perfect, and Hany Babu (2008) parses the form in (3) as the conjunctive participle plus an auxiliary form (*irikk-*) plus the tense marking. Given this, at first glance, one might think that the Malayalam Universal perfect parallels the English one in using a progressive participle plus the perfect participle of an auxiliary verb and then a tense auxiliary, as parsed in (7), to express a Universal perfect.

- (7) ezhuthi-kkond(u) irikk-uka(y) aanu
 write-PROG.PART be-PRF.PART TENSE.AUX
 cf. English ‘has been writing’

However, this dissertation argues that such a parse is incorrect for minimally the following three reason. The first is that *-uka* is not a perfect participle; it is a progressive viewpoint aspect marker/progressive participle marker, as argued in chapters 3 and 4. Secondly, *kondu* is not a progressive marker; it is a lexical aspect modifier. Finally, *irikk-* is not a perfect auxiliary; it is a viewpoint aspect auxiliary (glossed AUX). Building the last two arguments will be the focus of this chapter.

5.2 *kondu* is not a progressive participle; it is a lexical aspect modifier

Asher & Kumari (1997) cite *kondu* as the frozen Conjunctive Participle of the verb *koll-* ‘take.’ Past intuitions about the function of *kondu* have, generally, been that it is some kind of ‘continuousness’ marker (Mohanan 1983, Gopalkrishnan 1985, Asher & Kumari 1997, Madhavan (2006), Jayaseelan 2003). Asher & Kumari (1997) call it a progressive morpheme, and Jayaseelan (2003) states that it is an adverb meaning ‘when’ used to express the durative aspect.

This paper argues that *kondu* and *uka* are not both progressive viewpoint aspect markers. First, chapter 3 argued that *-uka* is a genuine progressive viewpoint aspect marker. One reason to think that *kondu* is not a progressive viewpoint aspect marker is that it only occurs with conjunctive participles (which chapter 4 argues are vPs). In other words, it has a much more restricted distribution than *uka* does. The genuine progressive viewpoint aspect marker, *-uka*, is what occurs with finite verbs.

A key argument of this section, given in (section 5.2.1) is that the function of *kondu* is to make accomplishment predicates (what *kondu* selects for) into activity predicates (which have the subinterval property). From this comes the larger claim of the chapter (discussed in section 5.2.2) that (unmarked) uses of the Universal perfect in Malayalam require that predicates that have the subinterval property as a result of their lexical aspect.

5.2.1 *kondu* and predicate type

In order to establish the claim that the function of *kondu* is to make accomplishment predicates (what *kondu* selects for) into activity predicates (which have the subinterval property) an examination of the behavior of *kondu* with different types of predicates is required. The investigating will begin with the use of *kondu* with accomplishment predicates.

The first relevant piece of data for accomplishment predicates comes from non-

Universal perfect contexts with what this chapter will argue to be a light verb use of *irikk-*. In these contexts, an ambiguity appears when there is no *kondu* in a sentence with an accomplishment predicate. Example (8-a) shows that, without *kondu*, it is not clear whether ‘Radha’ is still en route to the theater or if she is now sitting in the theater. When *kondu* is added, (8-b), it is clear that she must be en route to the theater. The sentence in (8-b) cannot be used when ‘Radha’ is sitting in the theater.

Context: You come to your friend Radha’s house to meet her, expecting to find her there. When you get there she is not there. Her father tells you...

- (8) a. raadha sinimu-kku pooy-irikk-uka(y)-aanu
 Radha cinema-DAT go.PART-irikk-PROG-be.PRES
 ‘Radha has gone to the cinema.’ [en route to the theater or sitting in the theater, we don’t know]
- b. raadha sinimu-kku pooy-i-kkond-irikk-uka(y)-aanu
 Radha cinema-DAT go-PART-LAM-irikk-PROG-be.PRES
 ‘Radha has gone to the cinema.’ [she is on her way now but hasn’t yet reached the theater]

Another example illustrating this point is given in (9). In the given context, the speaker needs to use the *kondu* marked form, (9-a) since he/she wants to emphasize that the action of learning is ongoing but not yet completed.¹

Context: You are a foreigner learning Malayalam. You meet someone for the first time. They are impressed with your Malayalam and say ‘So now you learned Malayalam.’ You want to emphasize in your reply that you did not fully learn Malayalam yet; you are simply engaged in the long process of learning Malayalam.

- (9) a. njaan malayalam padich-u-kond-irikk-uka(y)-aanu
 I Malayalam learn-PART-LAM-irikk-PROG-be.PRES
 ‘I am engaged in the ongoing process of learning Malayalam.’ [though speakers generally just translate it as ‘I am learning Malayalam.’]
- b. #njaan Malayalam padikk-uka(y)-aanu
 I Malayalam learn-PROG-be.PRES

¹The fact that the simple progressive form in (9-b) cannot be used here suggests that the progressive (*-uka*) is not completely parallel with that of the English progressive.

‘I am learning Malayalam.’

In sum, the role of *kondu* in (8) and (9) is to indicate that the activity is still ongoing and that ‘Radha’ in (8-b) has not yet reached endpoint of being in the theater and the speaker in (9-a) has not yet reached the endpoint of knowing Malayalam. One might put this in slightly more formal terms by saying that *kondu* modifies what would otherwise be an accomplishment predicate and makes it into an activity predicate.

In stative predicates the use of *kondu* first coerces a stative predicate to an accomplishment predicate (since this is what *kondu* selects for) and then further coerces that accomplishment predicate into an activity predicate. This process can be seen in (10).

Context: Asha and Unni had an arranged marriage three years ago. Asha’s mother is very worried about her because she has not adjusted to Unni and his family despite the fact that it has been three years.

- (10) muunnu varsham-aayi asha unni-ye
 three years-ADV Asha Unni-ACC
 sneehicch-u-kond-irikk-uka(y)-aanu
 love-PART-LAM-irikk-PROG-PRES
 ‘For three years Asha has been loving [doing duties of a wife for] Unni but
 she has not yet succeeded in loving him [accepting/growing accustomed to the
 duties required of her].’

The use of *kondu* here makes this sentence not about Asha’s feelings but rather about an activity that she is doing in order to reach an endpoint (becoming settled in her husband’s family). This is the first coercion the predicate undergoes: from a stative predicate to an accomplishment predicate. The fact that this first coercion occurs suggests that *kondu* does indeed select for an accomplishment predicate.

The sentence comments that for a span of three years Asha has been doing the actions/duties that a wife must do to be considered a good daughter-in-law/wife, but she is still having difficulties performing or accepting those duties. In other words, she is not settled in her role yet; she is still engaged in the process of moving towards that

end. This is the second coercion from an accomplishment predicate into an activity predicate.

Given all the coercion required to use *kondu* with a stative predicate, it should come as no surprise that this is not the most natural way to express a Universal perfect with a stative predicate in Malayalam. To express something about how long Asha has loved Unni (say in response to a question about how long they have waited before their families agreed to their marriage), the simple tenses of the progressive or imperfective are used, (11).

- (11) a. muunnu varsham-aayi asha unni-ye snehikk-unnu- \emptyset
 three years-ADV Asha Unni-ACC love-IMPFV-PRES
 ‘For three years, Asha has loved Unni.’ [lit. ‘For three years, Asha is loving Unni.’]
- b. muunnu varsham-aayi asha unni-ye snehikk-uka(y)-aanu
 three years-ADV Asha Unni-ACC love-PROG-PRES
 ‘For three years, Asha has loved Unni.’ [lit. ‘For three years, Asha is loving Unni.’]

The simple tense forms, unlike *kondu*, do not involve coercion and are, therefore, the unmarked way to say a Universal perfect with a stative predicate.

Turning to activity predicates, when *kondu* is used with an activity predicate in non-perfect contexts, it indicates that the activity is prolonged, (12). It is not felicitous to say (12-b) in the case of a sudden shower or to inform someone that it has started raining. The sentence in (12-a) is used in that case. Instead, (12-b) is used in a context of a long/heavy rain. For example, it might be used by your mother to caution you to take precautions (carry an umbrella, take a rain coat) or not to go out because the rain is going on continuously and not stopping.²

- (12) a. mazha peyy-uka(y)-aanu
 rain fall-PROG-be.PRES
 ‘It is raining.’

²Speakers, when presented the sentences in (12) out of the blue, will often say that there is no difference. This is because they are translating them into English, where both seem to basically mean ‘It is raining.’

- b. mazha peyth-u-kond-irikk-uka(y)-aanu
rain fall-PART-LAM-irikk-PROG-PRES
‘It is going on raining.’

Following the pattern from accomplishment and stative predicates, one could propose that the use of *kondu* first coerces an activity predicate into an accomplishment predicate (since this is what *kondu* selects for) and then coerces that accomplishment predicate back into an activity predicate. The ‘prolonged’ feel that (12-b) has is the result of this coercion. Evidence that this seems to be on the right track comes from the addition of the emphatic particle, *-ee*. Speakers comment that the prolonged feeling becomes more intense when this particle is attached to *kondu*, (13).

- (13) mazha peyth-u-kond-ee irikk-uka(y)-aanu
rain fall-PART-LAM-irikk-PROG-PRES
‘It is going *on* raining.’ [emphasizes the prolonged feeling]

This is as expected given that the position of *-ee* determines its scope, as can be seen in (14).

- (14) a. njaan-ee var-aam
I-EMPH come-MOD
‘I will come.’
- b. naale pattu manikk-ee var-uu
tomorrow ten o’clock-EMPH come-IMPER
‘Come at *ten* tomorrow.’
- c. paray-aan-ee paatilla
say-INF-EMPH PROHIB
‘(You) should not *talk*.’
- d. raaman ippoozh-ee var-un-n-ull-uu
Raman now-EMPH come-IMPV-be-EMPH
‘Raman is coming only *now*.’ (Asher & Kumari 1997 p178: 868-869, 871-873)

The simple tense forms, (15-a)-(15-b), on the other hand, do not involve any coercion.³

³The (15-a) sentence is the most natural one to use here. Speakers point out that the (15-b) sentence signals that the speaker wants to add some extra comment like ‘but even then (I didn’t win any prize)/and now (I want to study more).’

In Universal perfect contexts, speakers prefer simple tense form. The form using *kondu*, (15-c), is viewed as ‘overly formal/bookish.’ Given the amount of ‘unnecessary’ (in the sense that activity predicates already have the subinterval property before *kondu* is added) coercion involved, it is not at all surprising that speakers prefer the simple tense forms.

- (15) a. *njaan oru varsham aayi paad-unnu-∅*
 I one year ADV sing-IMPV-PRES
 ‘I have been singing for one year.’ [lit. ‘For one year, I am singing.’]
- b. *njaan oru varsham aayi paad-uka(y)-aanu*
 I one year ADV sing-PROG-be.PRES
 ‘I have been singing for one year.’ [lit. ‘For one year, I am singing.’]
- c. *njaan oru varsham aayi paad-i-kond-irikk-uka(y)-aanu*
 I one year ADV sing-PART-LAM-irikk-PROG-be.PRES
 ‘I have been singing for one year.’

In sum, this section has examined non-perfect and Universal perfect uses of *kondu* with accomplishment, stative and activity predicates and shown that *kondu* selects for an accomplishment predicate and then makes this predicate into an activity predicate.

5.2.2 Why use *kondu* in Universal perfects?

The question at this point why does Malayalam form the Universal perfect the way it does? In answering this question, it is useful to compare and contrast the different options Malayalam has for expressing Universal perfect readings with different aspectual classes.

The past section showed that Universal perfects in Malayalam can be expressed either with the morphology introduced in (7) or just with simple progressive or imperfective forms for stative and activity predicates. With stative and activity predicates, these simple progressive or imperfective forms are, in fact, the unmarked way to express the Universal perfect.

With accomplishment predicates, simple progressive or imperfective forms can also be used, (16-b)-(16-c). However, here, the *kondu* marked form, (16-a), is the

unmarked form which is the most natural way to answer a question like ‘What have you been doing lately?’. The use of the other forms is marked: especially when the *undu* is there, (16-b) is an answer to the question ‘Are you reading that paper?’. The sentences in (16-b)-(16-c), when said with stress on *aazhcha* ‘week,’ convey that the speaker is stressed that the paper is not finished and that they are not neutral statements.

- (16) a. njaan oru aazhcha aayi ii paper
 I one week ADV this paper
 vaayicch-u-kond-irikk-uka(y)-aanu
 read-PART-LAM-irikk-PROG-be.PRES
 ‘I have been reading this paper for one week.’
- b. njaan oru aazhcha aayi ii paper vaayikk-unnu-∅/undu
 I one week ADV this paper read-IMPV-PRES/be.PRES
 ‘I have been reading this paper for one week.’
- c. njaan oru aazhcha aayi ii paper vaayikk-uka(y)-aanu
 I one week become this paper read-PROG-be.PRES
 ‘I have been reading this paper for one week.’

These observations lead to a major claim of this chapter: (unmarked) uses of the Universal perfect in Malayalam require that predicates obtain the subinterval property via their lexical aspect, not through viewpoint aspect alone. In the case of stative and activity predicates, they both inherently have the subinterval property. As a result, the unmarked way to express a Universal perfect with them is just to use the simple progressive or imperfective form. Accomplishment predicates, on the other hand, do not, by themselves, have the subinterval property. The function of *kondu* is to make accomplishment predicates into predicates with the subinterval property (derived activity predicates). These predicates then all have the subinterval property via their lexical aspect.

Turning to the marked options, stative and activity predicates already have the subinterval property by themselves, and the addition of *kondu* requires a lot of, generally, unnecessary coercion. That is why verb forms with *kondu* yield additional shades of meaning beyond the basic meaning of the Universal perfect discussed in chapter 1.

Accomplishment predicates with simple tenses do not have the subinterval property via their lexical aspect. They get it from their progressive or imperfective viewpoint aspect. The violation of the general requirement that Universal perfects have the subinterval property via their lexical aspect results in these forms being marked in some way, possibility information structurally.

5.3 *irikk-* is not a perfect auxiliary; instead it has three functional, non-perfect uses

In addition to *kondu*, Universal perfect forms using this morphology also include a morpheme, *irikk-*, whose meaning when used as a productive lexical verb is ‘sit.’ The ‘first-glance’ parse of the Universal perfect of an accomplishment predicate is given in (17-a). The new and more accurate parse argued for in the previous section is given in (17-b).

- (17) a. vaayicchu-kond(u) irikk-uka(y) aanu
 read-PROG.PART be-PERFECT.PART TENSE.AUX
 cf. English ‘Has been reading’
- b. vaayicch-u-kond(u) irikk-uka(y) aanu
 read-PART-LAM ????-PROG be.PRES(TENSE.AUX)

The use of *irikk-* in the Universal perfect and the purported Existential perfect constructions is examined in sections 5.3.1 and 5.3.2, respectively. It will be argued that in the Universal perfect *irikk-* functions as a viewpoint aspect auxiliary. In the purported Existential perfect, its role is that of a light verb. Section 5.3.3 discusses the use of *irikk-* as ‘do’ support with the vP level negation *aa-*. Section 5.3.4 summarizes the arguments.

5.3.1 *irikk-* as a viewpoint aspect auxiliary

This section has four main arguments against *irikk-* being a perfect auxiliary in Universal perfect sentences like (17-b). The first is that *irikk-* is minimally, not just a perfect auxiliary; it has at least two other functional, non-perfect uses, namely, the ones that will be seen below: light verb and has ‘do’ support.

The second argument against *irikk-* being a perfect auxiliary is that *irikk-* is in the wrong morphological position in Universal perfects. To see this, look carefully at the order of the morphology in (4-a), repeated here as (18). *Irikk-* occurs to the left of both the progressive viewpoint aspect morphology and the present tense auxiliary.

- (18) njaan oru aazhcha aayi ii paper
 I one week ADV this paper
 ezhuth-i-kkond-irikk-uka(y)-aanu
 write-PART-LAM-AUX-PROG-be.PRES
 ‘I have been writing this paper for one week.’

Assuming the Mirror Principle Baker (1985) and that PerfP is located above AspP (Iatridou et. al. 2002, Pancheva 2003, a.o.), *irikk-* is not in the right position to be the spell out of stranded features a Perf head. If it was spelling out stranded features on a Perf head, it should appear in between the viewpoint aspect marker, *-uka*, and the tense auxiliary *aanu*. However, it does not appear in this position. The position it does occur in, though, is the right position to be the spell out of stranded features on an Asp head.

The third argument is that *irikk-* need not always be present in Universal perfects. As was seen in section 5.2, Malayalam allows, and, depending on the verb type, sometimes prefers, simple tense-aspect forms. This shows that, even if *irikk-* were a perfect marker/auxiliary, it is not an obligatory one. Table 5.1 provides a summary of these facts.

Predicate type	Unmarked form	Also possible
accomplishment predicate	<i>kondu+irikk-</i>	simple TA forms
stative & activity predicates	simple TA forms	<i>kondu+irikk-</i>

Table 5.1: Options for expressing Universal perfects in Malayalam

A fourth argument is that sometimes *irikk-* is present in a non-perfect verb which gains a Universal perfect reading in the presence of a durative adverb. Example (19-a) is not a Universal perfect sentence. It just expresses that the paper writing feels like it is never ending. However, when a durative adverb is added to the same sentence, (19-b), the sentence expresses a Universal perfect reading. Since *irikk-* appears both in a non-Universal perfect sentence like (19-a) and its Universal perfect counterpart, (19-b), this further suggests that it is not a perfect auxiliary.

- (19) a. njaan ii paper ezhuth-i-kkond-irikk-uka(y)-aanu
 I this paper write-PART-LAM-AUX-PROG-be.PRES
 'I am writing and writing this paper.'
- b. njaan oru aazhacha aayi ii paper
 I one week ADV this paper
 ezhuth-i-kkond-irikk-uka(y)-aanu
 write-PART-LAM-AUX-PROG-be.PRES
 'I have been I am writing this paper for one week.'

While *irikk-* does not match the distribution of a perfect auxiliary, it does seem to function as an auxiliary that is rescuing some stranded features on a head lower in the clausal spine than Perf. The supporting evidence for this is that whenever *kondu* appears, *irikk-* is obligatory. Example (20-a) shows that *kondu* marked verbs by themselves cannot serve as main 'finite' verbs. Example (20-b) shows that viewpoint aspect morphology cannot directly attach to a *kondu* marked verb. The unmarked option with an accomplishment predicate for fixing these problems, is for *irikk-* to be inserted between *kondu* and the progressive aspect marker *-uka*, (20-c). Another option, though it is more semantically marked, is for the the simple present progressive form, without *kondu*, to be used, (20-d). In the later case, no *irikk-* is present.

- (20) a. *njaan oru aazhacha aayi ii paper ezhuth-i-kondu
 I one week ADV this paper write-PART-LAM
 'I am writing and writing this paper.'
- b. *njaan oru aazhacha aayi ii paper
 I one week ADV this paper
 ezhuth-i-kkond-uka(y)-aanu
 write-PART-LAM-PROG-be.PRES

- 'I am writing and writing this paper.'
- c. njaan oru aazhacha aayi ii paper
 I one week ADV this paper
 ezhuth-i-kkond-irikk-uka(y)-aanu
 write-PART-LAM-AUX-PROG-be.PRES
 'I am writing and writing this paper.'
- d. njaan oru aazhacha aayi ii paper ezhuth-uka(y)-aanu
 I one week ADV this paper write-PROG-be.PRES
 'I have been writing this paper for one week.'

In sum, *irikk-* is not obligatory in all Universal perfects, only those where *kondu* appears. This is the kind of dependency that is expected if *irikk-* is an auxiliary that is inserted to rescue stranded viewpoint aspect features. This stranding occurs when the Lexical Aspect Modifier *kondu* intervenes between *v* and *Asp*, causing the *v* and LAM heads to agree and stranding the features on the higher heads. This is shown in (21). When *kondu* is not present, the progressive aspect feature is not stranded because *v* and *Asp* can directly agree, resulting in the (20-d) form.

(21)

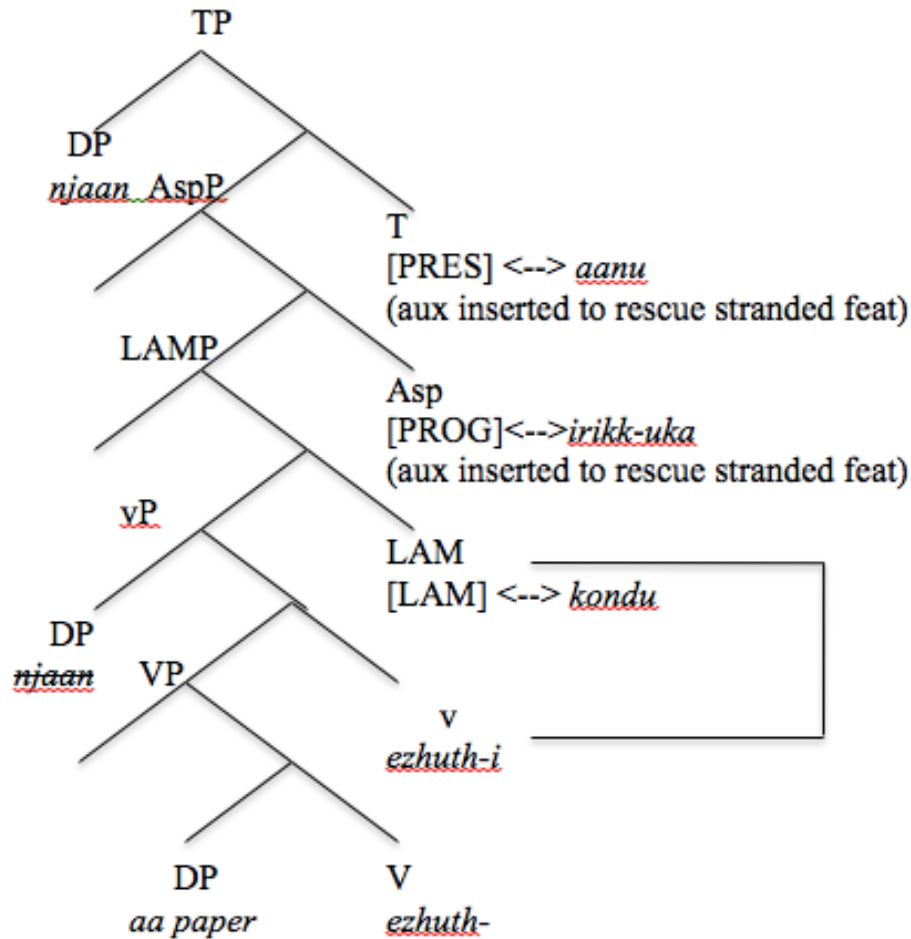

This section has argued that *irikk-* in Universal perfects is not a perfect auxiliary but a viewpoint aspect auxiliary. As such, all Universal perfects in Malayalam do not have any perfect morphology/perfect auxiliary. This viewpoint aspect auxiliary use is the first non-lexical use of *irikk-*.

5.3.2 Light Verb use of *irikk-*

The second non-lexical use of *irikk-* is found in what have been translated as Existential perfects by Asher & Kumari (1997). Specifically, the claim has been that there are two morphological ways to express an Existential perfect in Malayalam, as shown in (22).

- (22) a. Conjunctive participle (PART) + *ittu* + tense forms of the existential auxiliary *undu*

b. Conjunctive participle (PART) + *irikk-* + aspect & tense morphology

However, this section will argue that form in (22-b) is not an Existential perfect form but rather a light verb (LV) construction. There are a number of reasons, a priori, to think that this reanalysis might be a possibility. First, ‘sit’ commonly functions as a LV across languages (Hook & Pardeshi 2006). Secondly, LVs in Indo-Aryan languages attach to the Conjunctive Participle form Butt and Lahiri (2013). The examples above show that this is also the case for Malayalam, as what has been glossed as PART in this paper is the Conjunctive Participle. Thirdly, *irikk-* has a lexical use (‘sit’) in addition to its LV use and the LV use also inflects just like the lexical use.⁴ Fourthly, LV uses of *irikk-* occur below tense and aspect which is the expected place for LVs (Butt 2010, Butt & Lahiri 2013). Lastly, as can be seen below, LV uses of *irikk-* indicate surprise, and/or unexpectedness (cf. Bangla *bosh* ‘sit’ (Basu & Wilbur 2010)).

The final property of indicating surprise or unexpectedness provides a strong argument against *irikk-* being a perfect morpheme in the Existential perfect. The argument begins with the following observation: most speakers do not accept the form in (22-b) with *irikk-* in Existential perfects and instead require the usual Existential perfect form, given in (22-a), as shown in (23).

- (23) aval randu-yirathi pathrandu mudal oru sankeerthanam pole anjhu
 she two-thousand twelve since Oru Sankeerthanam Pole five
 pravasyam vaayicch-itt-undu /vaayicch-irikk-unnu-∅
 times read.PART-itt-be.PRS /read.PART-LV-IMPV-PRES
 ‘She has read *Oru Sankeerthanam Pole* five times since 2012.’

However, the same speakers who find (23) with the (22-b) form unacceptable find (24) to be completely natural with this form. If the (22-b) form is really an existential perfect morphology, this is very surprising, as nothing in previous accounts of the perfect predict that an Existential perfect should be licensed when an ‘instead of’ phrase is present but not licensed otherwise.

⁴See Hook & Pardeshi (2006) for potential issues with this test for LVs.

- (24) [randamoozham vaayikk-unn- \emptyset -ath-inu pakaram] aval
 Randamoozham read-IMPFV-PRES-NOMLZ-DAT instead she
 randu-yirathi pathrandu mudal oru sankeerthanam pole anjhu pravasyam
 two-thousand twelve since Oru Sankeerthanam Pole five times
 vaayicch-irikk-unn- \emptyset /vaayicch-itt-undu
 read.PART-LV-IMPFV-PRES /read.PART-itt-be.PRES
 ‘She has read *Oru Sankeerthanam Pole* five times since 2012 instead of read-
 ing *Randamoozham*.’

Insight into this puzzle comes from a persistent comment speakers have made. Every time speakers have accepted the sentence in (23) using the (22-b) form, they have commented that this sentence conveys a negative/sassy attitude. Speakers also make this comment about (24).⁵ Again this comment about attitude is puzzling if *irikk-* in (23) and (24) is a perfect morphology, since past accounts for the perfect do not make any link between the use of the perfect and the attitude the speaker is conveying. Empirically, while speakers’ first intuition is that the use of the (22-b) forms in (23) and (24) conveys a negative attitude, it is possible for such sentences to convey a positive attitude (for example, when the sentence is used in a context where a teacher is praising one student for going above and beyond what was expected) or for them to convey a neutral attitude (for example, when two equally good options for a reading project were given and someone chose a book different than the one someone else expected them to choose). This shows that the attitude the speakers conveys varies with the context.

Looking more carefully at the different contexts where the (22-b) forms are licensed shows that the use of these forms is not directly linked to either ‘instead of’ phrases or a particular attitude on the part of the speaker but rather to the indication of surprise or unexpectedness. Speakers more readily accept (24) than (23) due to the presence of the ‘instead of’ phrase because this phrase helps facilitate a

⁵Thanks to Hany Babu for sending me his handouts, which is where I first came across this puzzling set of data. Hany Babu (2008) provides similar sentences to (23) and (24), though those sentences do not have the adverbial modifications added here and use different titles. He claims that the (22-b) form is a perfect form but cannot be used for Existential perfect readings. However, he then provides a sentence like (24), though again without the adverbial modifications, and says that this sentence is totally acceptable and conveys that the speaker has a negative attitude. However, (23) and (24) should equally be Existential perfects, thereby presenting the puzzle.

context supporting surprise or unexpectedness. With just (23), speakers must infer this context themselves. Malayalam is not the only language with these type of facts. In Bangla, *bosh* ‘sit’ has both a main verb and a light verb use that expresses ‘the sudden, unexpected initiation of an event’ (p7) (Basu and Wilbur (2010)). As with Malayalam, it is more difficult to use *bosh* as a light verb in the Bangla equivalent of (23) than it is in (24).⁶ This further suggests that the present account for Malayalam is on the right track. Two additional data points that support this analysis are presented below.

The first data point was presented in section 5.2.1. It is repeated here as, (25-a).

Context: You come to your friend Radha’s house to meet her, expecting to find her there. When you get there she is not there. Her father tells you....

- (25) a. raadha sinimu-kku pooy-irikk-uka(y)-aanu
 Radha cinema-DAT go.PART-irikk-PROG-be.PRES
 ‘Radha has gone to the cinema.’ [en route to the theater or sitting in
 the theater, we don’t know]
- b. #raadha sinimu-kku pooy-itt-undu
 Radha cinema-DAT go.PART-itt-be.PRES
 ‘Radha has gone to the cinema.’

In this context, only the (22-b) form, the one using *irikk-*, is felicitous. The genuine Existential perfect form, (22-a), is infelicitous in this context.⁷ Instead, the sentence in (25-b) is the answer to the question ‘Has Radha ever gone to the cinema?’. The sentence in (25-a) expresses that, contrary to your expectations, ‘Radha’ is not at home; instead, she is at or on the way to the cinema.

The second additional example in support of the light verb use of *irikk-* comes from a subtle variation in the way that the standard greeting can be answered. A usual way to start a conversation with a Malayali who you have met before is to start by asking the question in (26).

⁶Thanks to Ishani Guha for her Bangla judgments.

⁷See section 5.4 for a discussion on the meaning of *ittu*.

- (26) sugam aan-oo?
 well be.PRES-Q
 ‘Are you well?’

It can be answered in at least three ways, given in (27). The most common one is (27-a). After this, the next question will probably be *kazhicch-oo* ‘Did you eat?’ After answering that question, a possible next question is the one in (28). This question can be answered using any of the forms in (27). Speakers comment that the forms in (27-b)-(27-c) are more polite than (27-a) when speaking about other people. This is because they assume that the person asking the question has a genuine worry or concern (a type of mild expectation) that the speaker’s parents might not be well, which is why the person asking the question has made the inquiry. It is a way of saying ‘Everything is really well.’ It shows happiness on the part of the speaker that the person who asked her the question is taking care for the speaker’s family members. If (27-a) is used to answer (28), there is an assumption that the person asking does not actually care about the speaker’s parents, which is why it is viewed as less polite.

- (27) a. sugam aanu
 well be.PRES
 ‘I/they am/are well.’
- b. sugam aay-irikk-unnu-∅
 well be.PART-LV-IMPFV-PRES
 ‘I/they am/are well.’ [contrary to your doubt/worry]
- c. sugam aay-itt-irikk-unnu-∅
 well be.PART-LV₁-LV₂-IMPFV-PRES
 ‘I/they am/are well.’ [completely][contrary to your doubt/worry]
- (28) achan-um amma-kk-um sugam aan-oo?
 father.DAT-CONJ mother-DAT-CONJ well be.PRES-Q
 ‘Are your parents well?’

Oftentimes speakers will say that (27-b)-(27-c) are not felicitous responses when answering a question about themselves. However, this is not, in fact, true. The response in (27-c) is completely acceptable in a context where the speaker sees someone (say at a function) whom he/she really likes and did not expect to see. When that person

asks the speaker (26), (27-c) is a perfectly natural response. Also, if a close friend or family member asks (26), a speaker might also respond with (27-b) or (27-c) in cases where she wants to convey that she is very happy that the friend or family member is taking care/worrying about her.

Answering (26) with (27-a) does not have the same impolite overtones as it would as an answer to (28) probably because it is more accepted that even people who do not genuinely care have a social obligation to ask (26), while asking (28) shows at least some attempt at showing care, even if it is not totally genuine. Example (27-a) is probably the most preferred answer to (26) precisely because asking (26) is a social obligation: the person asking may really care or not, but either way they are socially obliged to ask.

In sum, what Asher & Kumari (1997) translate as Existential perfect uses of *irikk-* are, in fact, light verb uses that express ‘surprise/unexpectedness’ in the purported Existential perfect contexts. This accounts for an otherwise puzzling pattern of acceptability judgments. The fact that *irikk-* can be used as an auxiliary and a light verb, in addition to its lexical use, in contemporary Malayalam is unsurprising as a given verb in other South Asian languages, such as Urdu and Bangla, can function as a LV, Aux and lexical verb usage (Butt & Lahiri 2013). One could formalize these facts by proposing that LV *irikk-* spells out an Init head in a first phase syntax Ramchand (2008), as Basu & Wilbur (2010) have argued for LV uses of Bangla *bosh* ‘sit’).

5.3.3 *irikk-* as ‘do’-support

The third and final functional use of *irikk-* is as ‘do’ support with the vP-level negation *aa-*. When this negation is used, as in (29), *irikk-* must appear, even though the positive sentences do not have an *irikk-*, (30). The *irikk-* in (29-a) is functioning as the main, ‘finite’ verb in the sentence. Unlike with the LV use of *irikk-*, these sentences carry no meaning of surprise or unexpectedness. LVs are also generally not obligatory, which is not the case when *aa-* negation is present, as can be seen in (31).

- (29) a. rajan pazhum kazhikk-aath-irunn-u
 Rajan banana eat-NEG-DO-PAST
 ‘Rajan did not eat a banana.’
- b. kutti [PRO ood-aathe irikk-uvaan] sramicch-u
 child run-NEG DO-INF try-PAST
 ‘The child tried not to run.’ (Amritavalli 2014: 26b)
- (30) a. rajan pazhum kazhicch-u
 Rajan banana eat-PAST
 ‘Rajan ate a banana.’
- b. kutti [PRO ood-uvaan] sramicch-u
 child run-INF try-PAST
 ‘The child tried to run.’
- (31) a. *rajan pazhum kazhikk-aath-u
 Rajan banana eat-NEG-PAST
 ‘Rajan did not eat a banana.’
- b. *kutti [PRO ood-aath-uvaan] sramicch-u
 child PRO run-NEG-INF try-PAST
 ‘The child tried not to run.’

One might object to a ‘do’ support analysis for the use of *irikk-* in (29) for the following two reasons. First, one might wonder why *irikk-* is needed with infinitives, (29-b), since this environment is not a place where ‘do’ support occurs in English. Work by Bjorkman (2011) may provide some insight here. Bjorkman argues that ‘do’ support in English, Breton, Monese and the mainland Scandinavian languages occurs when *v* is pronounced separately from *V*. This happens as a result of the locality requirement on agreement with *T*, (32), conflicting with another language specific requirement.

- (32) *T* must be immediately local to any inflectional head *X* with which it has an Agree relationship. (Bjorkman 2011 p196: 20)

One of Bjorkman’s main points is that ‘do’ support can look quite different from language to language and need not occur as a last resort type operation (contra Chomsky (1957), Chomsky (1991); Lasnik (1990); Pollock 1989; Bobaljik 1995; Embick & Noyer

2001, a.o.). This suggests that a more in-depth study of ‘do’ support in Malayalam is required before the ‘do’ support analysis is rejected.⁸

Secondly, another fact which also indicates that further studies of ‘do’ support in Malayalam would be insightful, is that Malayalam has a verb that means ‘do’ *cheyy-* which also has some ‘do’ support like uses (Asher & Kumari 1997, Paul (2013)). A use of *cheyy-* ‘do’ as ‘do’ support can be seen by examining the examples in (33). Finite sentences cannot be coordinated in Malayalam, (33-a). Instead, the progressive, *uka*, forms of the finite verbs are used. The conjunction marker *um* is added to them, and the verb *cheyy-* ‘do’ is used as the main ‘finite’ verb, i.e. as ‘do’ support, (33-b).⁹ Just as with English ‘do’ support, no *cheyy-* is inserted when an auxiliary is already present in the positive form, (34), (cf. *John did not study history* vs *John was not studying history*).

- (33) a. **vinu history padicch-u-yum anu veliyil kalicch-u-yum.*
 Vinu history study-PAST-CONJ Anu outside play-PAST-CONJ
 ‘Vinu studied history and Anu played outside.’
- b. *vinu history padikk-uka-yum anu veliyil kalikk-uka-yum*
 Vinu history study-PROG-CONJ Anu outside play-PROG-CONJ
cheyth-u.
 do-PAST
 ‘Vinu studied history and Anu played outside.’
- (34) *vinu history padikk-uka-yum anu veliyil kalikk-uka-yum*
 Vinu history study-PROG-CONJ Anu outside play-PROG-CONJ

⁸One might try to say that *irikk-* in (29) is functioning as some type of auxiliary. However, it is not clear how saying *irikk-* here is an auxiliary would fair any better with the infinitive problem, since there should not be any stranded tense features with an infinitive. Maybe, though, Malayalam infinitives do have tense features (cf. Menon 2011) and this is playing a role. The main issue though with this analysis is that the presence of negation does not cause auxiliaries (as defined by Bjorkman 2011, under review) to appear.

⁹*cheyy-* ‘do’ also has a light verb use, (i-b), as well as a main verb use, (i-a).

- (i) a. *kuttikal innale endu cheyth-u?*
 kids yesterday what do-PAST
 ‘What did the kids do yesterday?’
- b. *sudha ayaal-e googil cheyth-appool aan-ee...*
 Sudha that-man-ACC Google do.PAST-at.that.time be.PRES-EMPH
 ‘It was (only) when Sudha googled that guy, that..’ (Paul 2013)

aayirunnu.

be.PAST

‘Vinu was studying history and Anu was playing outside.’

The different environments where ‘do’ support is found in Malayalam are linked with a particular ‘do’ support verb: *irikk-* cannot be substituted for *cheyy-* in (33-b), nor can *cheyy-* be substituted for *irikk-* in the examples in (29). These facts raise a number of interesting questions that suggest that further studies of the different types of ‘do’ support in Malayalam would be productive.

5.4 Implications for compositionality

Before moving on to the implications of the claims in this chapter for compositionality, this section will begin with a quick review of the main claims in the chapter so far. Section 5.2 argued that the function of *kondu* is make accomplishment predicates (what *kondu* selects for) into activity predicates (which have the subinterval property) and that (unmarked) uses of the Universal perfect in Malayalam require that predicates obtain the subinterval property via their lexical aspect, not through viewpoint aspect alone. Section 5.3 argued that *irikk-* is never used as a perfect marker. Instead, it has, in addition to its lexical use as a main verb meaning ‘sit’, three non-perfect, functional uses: as a viewpoint aspect auxiliary in finite forms containing *kondu*, as a light verb indicating surprise or unexpectedness in purported ‘Existential’ perfect forms, and as ‘do’ support with *aa-* negation.

The remainder of this section will situate this chapter within broader questions regarding how compositional semantics work given cross-linguistic variation and the nature of what the clausal spine can contain in human languages. Two main questions will be focused on: first, how perfect semantics are obtained in the absence of perfect morphology and second, how to differentiate between auxiliaries, light verbs and ‘do’ support.

This chapter has claimed that Malayalam always lacks perfect morphology in, at least, the Universal perfect. If this is indeed correct, it raises questions about how

Universal perfect semantics are compositionally obtained when there is no perfect morphology present. In moving this investigation forward, an important point is that Malayalam is not alone in raising this question. For example, Greek (Iatridou et. al. 2002), Turkish (Arslan-Kechriotis (2006)), and Georgian also lack perfect morphology and instead use simple tenses in combination with durative adverbs to express the Universal perfect. Examples from these languages are given below.¹⁰ The (b) examples in (35)-(37) show that, without the durative adverb, the sentences simply have a present progressive meaning. When the durative adverb is added to the same sentences, the meaning changes to that of a Universal perfect, (a) examples.

Turkish

- (35) a. Bir haftadır bu makaleyi oku-yor-um.
 One week.for this paper.ACC read-IMPFV-1sg
 ‘I have been reading this paper for one week.’ [lit. ‘I am reading this paper for one week’]
- b. Bu makaleyi oku-yor-um.
 this paper.ACC read-IMPFV-1sg
 ‘I am reading this paper.’

Georgian

- (36) a. (me) am tsigns erti kviraa vkitkhulob.
 I.NOM this.DAT paper.DAT one week am.reading
 ‘I have been reading this paper for one week.’ [lit. ‘I am reading this paper for one week’]
- b. (me) am tsigns vkitkhulob.
 I.NOM this.DAT paper.DAT am.reading
 ‘I am reading this paper.’

Greek

- (37) a. diavazo afto to paper (gia) mia vdomada.
 Read.PERS.1SG this the paper (for) a week

¹⁰Thanks to Isa Bayirili (Turkish), Salome Shaverdashvili (Georgian), Despina Ikonou (Greek), and Snejana Iovtcheva (Bulgarian) for their judgments.

‘I have been reading this paper for one week.’ [lit. ‘I am reading this paper for one week’]

- b. diavazo afto to paper.
Read.PERS.1SG this the paper
‘I am reading this paper.’

The lack of perfect morphology raises questions about whether or not Malayalam (and the other languages) lack a PerfP and a perfect feature in the morphosyntax for Universal perfect constructions.

Furthermore, some languages like Bulgarian (Iatridou et al 2002, Pancheva 2003, 2013) do have perfect morphology that can be used in the Universal perfect but, additionally, allow the simple tense forms of the progressive to be used, (38). What subtle meaning differences exist between the possible Universal perfect forms in languages like Bulgarian and Malayalam, in which there can be more than one option to choose from, is another open question.

Bulgarian

- (38) a. (az) cheta тази книга от една седмица
I read.1SG.PRES this book from/since one week
‘I have been reading this book for one week.’ [lit. ‘I am reading this book for one week’]
- b. (az) cheta тази книга
I read.1SG.PRES this book
‘I have been reading this book.’

The possibility of using the simple tenses to express the Universal perfect in some languages raises the question of why English cannot use simple tenses in the Universal perfect, (39). The locus of this difference might be in the semantics of the perfect or in the semantics of tense.

- (39) a. *I am playing basketball since my childhood.
b. *I am writing this paper for one week.
c. *I am loving John since 2000.

One question related to the perfect in Malayalam that this chapter leaves open is whether or not there is perfect morphology in the Existential perfect. While Georgian and Greek do not have perfect morphology in Universal perfects, they do have perfect morphology in Existential perfects, (40)-(41).

Georgian

- (40) a. (me) es tsigni tsavikikhe
 I.NOM this.NOM paper.NOM read.PAST
 ‘I read this paper.’
- b. (me) es tsigni tsakitkhuli makvs
 I.NOM this.NOM paper.NOM have.read before
 ‘I have read this paper before.’

Greek

- (41) a. afto to arthro to diavasa htes
 this the article it.CL read.PAST.1sg yesterday
 ‘I read this paper yesterday.’
- b. afto to arthro to eho diavasi paliotera
 this the article it.CL have.1SG read.PART in.the.past
 ‘I have read this paper before.’

Turkish, however, lacks any kind of perfect morphology whatsoever and, therefore, only uses simple tense forms to express the Existential perfect, (42).

- (42) a. Bu makaleyi oku-du-m
 this paper.ACC read-PAST-1sg
 ‘I read this paper.’
- b. Bu makaleyi daha.once oku-du-m
 this paper.ACC before read-PAST-1sg
 ‘I have read this paper before.’

In order to figure out whether Malayalam is like Turkish (has no perfect morphology at all) or like Greek/Georgian (has perfect morphology only in Universal perfects) a closer examination of the (22-a) morphology (Conjunctive Participle + *ittu* + tense forms of *undu*) must be conducted. The fact that Malayalam uses a participle plus

a copula with existential force in the Existential perfect is unsurprising. This leaves the somewhat mysterious piece *ittu*.

Gaining an understanding of the contribution of the morpheme *ittu* is the crucial task here. It is the past tense/Conjunctive Participle form of *id-* ‘put, drop (down)’. Past intuitions have been that, beyond its lexical use, it has a functional use as a perfective marker, which is the mirror opposite of the so-called ‘progressive’ marker, *kondu* (Asher & Kumari 1997, Jayaseelan 2003). This chapter, though, has argued against *kondu* being a progressive morpheme. Looking forward, there are some reasons to doubt that *ittu* is a perfective viewpoint aspect marker.

First, *ittu* is not required to obtain perfective viewpoint aspect semantics on main verbs in Malayalam. Chapter 2 argues that Malayalam lacks [perfective] features in the syntax based on evidence from the distribution of auxiliaries and instead finite verbs which lack [PROG] or [‘IMPFV’] viewpoint aspect features receive perfective semantics via default mechanism. If *ittu* is the spell out of a [PERFV] viewpoint aspect feature, then one would expect it to regularly occur when verbs express perfective viewpoint aspect. However, this is not the case, as the most common way to express a finite perfective aspect in Malayalam is just by using the simple past tense form (i.e. *avan kazhicch-u* ‘He ate.’), which obtains its perfective semantics via a default mechanism.

Secondly, when *ittu* is the ‘final’ morpheme in a finite verb, it seems to function as a light verb, which emphasizes completion, (43-b). This sentence could be used in a context where a mom feels stressed because she has too many things to do and the compound is a complete mess. She feels at the end of her rope and is wondering what to do. Then when she comes home from work, she finds that her daughter has cleaned the compound until it sparkles. She feels so happy that she tells her friend (43-b) to express how through her daughter’s cleaning job was.

- (43) a. *aval muttam thuutth-u*
she compound sweep-PAST
‘She swept the compound.’

- b. aval muttam thuutth-itt-u
 she compound sweep.PART-LV-PAST
 ‘She swept the compound.’ [completely] (Gopalkrishnan 1985 p180: 93)

That this light verb use should exist is not surprising, since *ittu* has a lexical counterpart and the corresponding verb in Kannada and Telugu also has a light verb use indicating completion¹¹. Additionally, in support of a light verb account is the fact that *ittu* can co-occur with light verb uses of *irikk-* to indicate how completely well the speaker is, (44-a).

The intuition that *ittu* and *kondu* are mirror opposites seems on the right track in that they sometimes target a similar morphological position, i.e. between the Conjunctive Participle and below either the light verb or viewpoint aspect use of *irikk-*, (44).

- (44) a. avar sugam aay-itt-irikk-unnu- \emptyset
 they well be.PART-LV₁-LV₂-IMPFV-PRES
 ‘They are well.’ [completely] [contrary to your doubt/worry] [emphasizes
 ‘wellness’]
- b. njaan ii paper ezhuth-i-kkond-irikk-unnu- \emptyset
 I this paper write-PART-LAM-AUX-IMPFV-PRES
 ‘I am writing and writing this paper.’

The use of *kondu* and *ittu* in Conjunctive Participle Constructions also suggests that this ‘mirror opposites’ intuition is on the right track. In a Conjunctive Participle Construction where the Conjunctive Participle is unmarked with either *kondu* or *ittu*, (45-a), and both predicates are non-instantaneous events, all three readings (simultaneous, sequential or proper containment) are possible, as discussed in chapter 4 section 3. However, when *kondu* is added, as in (45-b), only a simultaneous reading is possible.¹² When *ittu* is added, only a sequential reading is allowed, (45-c).

¹¹Rahul Balusu, Madhu V., Sindhu Herur and Suma Kodandaram, (p.c.)

¹²This chapter proposed that *kondu* is a lexical aspect modifier that selects for an accomplishment predicate and then turns that predicate into an activity predicate. However, in (45) the Conjunctive Participle is an activity predicate. This predicts that the same kind of prolonged feeling that *kondu* creates with other activity predicates, due to coercing the activity predicate into an accomplishment predicate and then back into an activity predicate, should be present in (45-b). Perhaps this is part of why the addition of *kondu* indicates a simultaneous reading. However, it cannot be the whole

- (45) a. avan paatu keett-u paper ezhuth-i.
 he song hear-PART paper write-PAST
 ‘He listened to music and wrote a paper.’[simultaneous, sequential or
 proper containment]
- b. avan paatu keett-u-kondu paper ezhuth-i.
 he song hear-PART-LAM paper write-PAST
 ‘He listened to music while he wrote a paper.’[simultaneous reading only]
- c. avan paatu keett-ittu paper ezhuth-i.
 he song hear.PART-ittu paper write-PAST
 ‘He listened to music then wrote a paper.’ [sequential reading only]

In light of this apparent parallelism and *ittu*’s light verb uses, one might wonder if *kondu* is a light verb. An additional reason for thinking that is that *koll-* ‘take’, the lexical meaning of the form that *kondu* is etymologically related to, is a common light verb across languages (Hook & Pardeshi 2006). However, Butt and Tantos (2004) argue that light verbs always have a main verb counterpart, which *kondu* does not in contemporary Malayalam. Hook and Pardeshi (2006) counter that languages can have light verb ‘orphans’ and use Tamil *kol-* ‘hold, contain’ as an example. Butt & Lahiri (2013) respond that a more careful investigation of these ‘orphan’ light verbs is required to make sure that they are really light verbs in the sense that Butt and coauthors use the term ‘light verb.’ As such, this thesis remains neutral concerning whether or not *kondu* is a light verb in the sense meant by Butt and coauthors.

However, this parallelism does not always hold: *ittu* can appear in higher positions in the clausal spine than *kondu*, (46). Here it occurs after both *kondu* and the viewpoint aspect auxiliary use of *irikk-*.

- (46) innale aathri avan valare neeram
 yesterday night he much time
 vaayicch-u-kond-irunn-itt-undaayirunnu
 read-PART-LAM-AUX.PART-itt-be.PAST
 ‘Last night he had been reading for a long time.’ (Asher & Kumari 1997,

answer because it should, in principle, be possible to have a prolonged event proceeded/ followed by another event (sequential reading) or a prolonged event contained inside another longer event/a shorter event contained inside the prolonged event (proper containment reading). In other words, all three readings should still be possible in (45-b) given what has been said so far.

Given that the use of *ittu* in (46) seems to fit that of an Existential perfect, one might think that *ittu* can function as perfect morphology in Existential perfects, in addition to having a light verb and lexical use. Some further support for such a position comes from (47). The sentence in (47-b) is not a felicitous answer to the question in (47-a); instead (47-c) must be used in this context.

- (47) a. zoo-il pooy-itt-und-oo?
 zoo-LOC go.PART-itt-be.PRES-Q
 ‘Have you gone to the zoo (before)?’
- b. #zoo-il pooy-i
 zoo-LOC go-PAST
 ‘I went to the zoo.’
- c. zoo-il pooy-itt-undu
 zoo-LOC go.PART-itt-be.PRES
 ‘I have gone to the zoo (before).’

Seeing as there are potential multiple uses of *ittu*, determining its semantic contribution in Existential perfects will be left to further research. Even if *ittu* turns out to be a perfect morpheme, the Universal perfect in Malayalam still presents a puzzle for the Principle of Compositionality (PoC). That PoC puzzle also exists cross-linguistically in languages that Malayalam is not related, as summarized by Table 5.2 .

language	language has perf morph	obligatory morph in U perfs	obligatory morph in E perfs	has PoC puzzle
English	yes	yes	yes	no
Bulgarian	yes	no (multiple options)	yes	yes
Modern Greek	yes	no (cannot be used)	yes	yes
Georgian	yes	no (cannot be used)	yes	yes
Malayalam	???	no (either n/a or cannot be used)	???	yes
-	-		-	-
Turkish	no	n/a	n/a	yes

Table 5.2: Perfects & the Principle of Compositionality

Looking forward, one hypothesis for solving the PoC puzzle is that languages that allow non-perfect marked verbs to express perfect semantics rely more heavily

on aspectual information when no perfect morphology is present. There are at least two reasons to think that this hypothesis might be on the right track. The first is that Iatridou et al. (2002) have argued that the aspectual semantics of the verb forms involved in expressing the perfect in Greek can explain why Greek cannot use the perfect morphology it has for the U perfect. Secondly, the tenseless literature, as outlined in chapter 2, has argued that tenseless languages use a combination of lexical and/or viewpoint aspect, temporal adverbs and pragmatic mechanisms to obtain tense semantics. It seems plausible that languages which lack perfect morphemes might tap into the same type of mechanisms that tenseless languages use to convey temporal semantics in the absence of tense morphemes.

A second question regarding the nature of the clausal spine has to do with the function of light verbs, auxiliaries, and ‘do’ support. Though Malayalam lacks perfect morphology, at least in Universal perfects, it has a rich array of other verbal morphology. Work by Butt (Butt (1995), et seq.) and Bjorkman (2011, under review) has shed light on what labels such as ‘light verb,’ ‘auxiliary,’ and ‘do’ support’ actually mean and how morphemes should be assigned to one of these categories. However, there is still much work to do. Further study of the following two puzzles from Malayalam can potentially further contribute to this investigation.

The first puzzle has to do with why *irikk-*, as opposed to one of the ‘being’ verbs (*aanu* or *undu*), is chosen as the aspect auxiliary in the Universal perfect. One idea might be that Bjorkman (under review, 2011) is right that auxiliaries are present only to rescue stranded features and therefore copulas like *aanu* may have no real semantics of their own. Instead, they originate higher in the structure, simply as the spell out of stranded tense features. This is in line with the argument in chapter 3 that *aanu* is the elsewhere copula in Malayalam. *Undu*, on the other hand, has some semantic content (minimally existential content along with whatever triggers the immediacy requirement in certain cases), in addition to spelling out stranded tense features, but this content makes it less than ideal for use as a ‘low’ auxiliary. *Irikk-*, though, has a fully lexical verb usage, which suggests it is built at a lower point in the clausal structure, such as in the first phase (Ramchand 2008). Perhaps

this is why it is selected as the auxiliary for lower stranded Asp features. Much of course, still needs to be worked out here.

A second puzzle is what governs the use of *cheyy-* ‘do’ versus *irikk-* ‘sit’ as ‘do’ support? A possible intuition to probe here comes from Aboh (2016). He argues that Serial Verb Constructions (SVC) in Kwa languages (which involve a number of different verbs) are created via auxiliiation, (48).

- (48) Auxiliation: ‘verbal form is combined with another verb form in order to express TAM, quantification or introduce an additional argument[express] cause, manner, instrument associated with V2, the main predicate’ (slide 26, 40)

He further argues that there are different locations of Auxiliation cross-linguistically: main verbs in SVC in Kwa languages occur to the RIGHT of the Voice Projection while main verbs in SVC in Romance languages occur to the LEFT of the Voice Projection. Some Creole languages combine these two strategies (Mufwene (2001), Mufwene (2008); Aboh (2009), Aboh (2015), Aboh (2016)). For example, since Haitian Creole has both the French LEFT and the Kwa RIGHT strategy, it can use both at the same time. His claim is ‘all languages seem to display some form of auxiliiation that is very much like serialization.’ (slide 74). Jayaseelan (2004) points out that what he calls SVCs in Malayalam (which includes *irikk-* in Universal perfect constructions using *kondu*) often have aspectual and modal functions. In sum, more careful work is needed to investigate the nature of perfects, auxiliaries, light verbs, SVC, ‘do’ support and their implications for the clausal spine and the Principle of Compositionality.

Chapter 6

Conclusion

This dissertation began with two broad questions: what type of cross-linguistic variation occurs and why do languages differ from one another in these particular ways? It then focused on four known points of cross-linguistic variation in the verbal domain: tense, aspect, finiteness and the perfect. The Dravidian language Malayalam served as the case study for the dissertation.

After providing a summary of the background on tense, aspect and the perfect assumed and a review of the tenseless literature in chapter 2, chapter 3 went on to argue that Malayalam, indeed, has tense morphology and a TP. The evidence for this claim came from adverb and context tests, Universal Perfects, the distribution of auxiliaries and the obligatory nature of predicate copulas. It then pointed out that Malayalam has two morphemes, one of which corresponds, to a progressive morpheme and one of which seems to be an imperfective morpheme. However, it was then shown that the ‘imperfective’ morpheme differs from standard imperfective morphemes in allowing accidental generalizations and having an episodic nature. It was shown that this form is used when a situation involves multiple, temporally connected episodes taking place within close succession, like an iterative. But it differs from an iterative in that it cares that these iterations take place within another interval, i , in the actual world. Because this interval has or gets the subinterval property, it results in accidental generalizations over these episodes. Because the Topic Time is contained in the Situation Time, this gives a Klein (1994) progressive meaning while

the ‘generalizing’ step that gives the progressive meaning also results in a report on the state of things in the actual world, i.e. the ‘generic’ use of *unnu*. This results in it having the appearance of an imperfective. The remainder of chapter 3 explored the different uses of the two copulas in Malayalam. It showed that *undu* is the existential copula also used to express possession. When it is used in location, psychological and medical predicates, it expresses immediate situations (cf. Patel-Groszs (2016) immediacy requirement in negative imperatives cross-linguistically). *aanu* was argued to be the elsewhere copula.

Chapter 4 began with the question of how to differentiate non-finite forms from each other in a given language. Its specific goal was to closely examine three specific forms that have been classified as being non-finite in Malayalam, non-finite uses of *-uka*, Conjunctive Participles and *-athu* nominalizations, in addition to the two types of negation Malayalam has, one of which is generally seen as ‘finite’ and the other as ‘non-finite’. It showed that a characterization of negation in terms of finiteness faces a number of problems and suggested that an account based on scope differences might be a better option. It then examined the behavior of non-finite uses of *-uka* and argued that these uses are progressive participles. It then turned to Conjunctive Particles and argued that they are structurally small, roughly vPs, and it argued that multi-verb constructions are semantically underspecified for tense and viewpoint aspect and require the clauses involved to be pragmatically linked either via causation, manner or sequence of events. It then claimed that these constructions are modified version of a Stump (1985) style approach. Finally, it examined the behavior of *-athu* nominalizations. This chapter argued that these forms are nominalization simply takes place somewhere after, not before, the TP (cf. Borsley & Kornfilt 2000, Baker 2011). The main evidence for this hypothesis came from similarities between *athu* nominalizations and relative clauses and the presense of tense morphemes in *-athu* nominalizations.

Chapter 5 examined the perfect in Malayalam. It showed that there are a number of ways to express a Universal perfect in Malayalam. Some of the options use the morphemes *kondu* and *irikk-*. Chapter 5 examined the role of *kondu* in non-perfect

and Universal perfect uses with accomplishment, stative and activity predicates and showed the function of *kondu* is make accomplishment predicates (what *kondu* selects for) into activity predicates (which have the subinterval property) and that (unmarked) uses of the Universal perfect in Malayalam require that predicates obtain the subinterval property via their lexical aspect, not through viewpoint aspect alone. It then showed that *irikk-* has three, non-perfect functional uses: as a viewpoint aspect auxiliary with *kondu*, as a light verb indicating ‘surprise/unexpectedness’ and as a type of ‘do’ support. A major claim of this section is that Malayalam never uses perfect morphology to express Universal perfects. The final section of chapter 5 situated this fact in the cross-linguistic perspective and considered the implications this has for compositionality.

Appendix A

Additional differences between *-uka* and *-unnu undu*

The data here are from Hany Babu & Madhavan 2003: 21-35.

stative verbs

- (1) a. manju diliipan-e sneehikk-unnu-undu
Manju Dileepan-ACC love-IMPFV-PRES
'Manju loves Dileepan.'
- b. nii paranj-a kaaryam njaan oorukk-unnu-undu
you say.PAST-REL matter I remember-IMPFV-PRES
'I remember what you said.'
- (2) a. *manju diliipan-e sneehikk-uka(y)-aanu
Manju Dileepan-ACC love-PROG-PRES
'Manju loves Dileepan.'
- b. *nii paranj-a kaaryam njaan oorukk-uka(y)-aanu
you say.PAST-REL matter I remember-PROG.PRES
'I remember what you said.'

manner advs

- (3) a. omana nann-aayi paadu-unnu-undu
Omana good-adv sing-IMPFV-PRES
'Omana is singing well.'

- b. omana (*nann-aayi) paad-uka(y)-aanu
 Omana good-adv sing-PROG-PRES
 ‘Omana is singing well.’

non-agentive subject

- (4) a. ente vaacchu nadakk-unn-undu
 I.GEN watch walk-IMPFV-PRES
 ‘My watch is working.’ [lit. ‘My watch is walking.’]
 b. aa peena ezhuth-unn-undu
 that pen write-IMPFV-PRES
 ‘That pen writes.’
- (5) a. *ente vaacchu nadakk-uka(y)-aanu
 I.GEN watch walk-PROG-PRES
 ‘My watch is working.’ [lit. ‘My watch is walking.’]
 b. *aa peena ezhuth-uka(y)-aanu
 that pen write-PROG-PRES
 ‘That pen writes.’

unaccusatives

- (6) a. avide pani (usaar-aayi) nadakk-uka(y)-aanu
 there work (energetic-adv) walk-PROG-PRES
 ‘Work is going on very well there.’
 b. avan pani nada-tth-uka(y)-aanu
 he work walk-CAUS-PROG-PRES
 ‘He is managing the work.’
 c. avan vallaathe moosam-aayi var-uka(y)-aanu
 he very.much bad-adv come-PROG-PRES
 ‘He is becoming very weak.’

indefinite NPs

- (7) a. puratthu oru aal nilkk-unn-undu
 outside one man stand-IMPFV-PRES
 ‘There is a man standing outside.’
 b. *puratthu oru aal nilkk-uka(y)-aanu
 outside one man stand-PROG-PRES
 ‘There is a man standing outside.’

- (8) a. oru aal puratthu nilkk-unn-undu
 one man outside stand-IMPV-PRES
 ‘One (of the men) is standing outside.’/‘There is a man standing outside.’
- b. oru aal puratthu nilkk-uka(y)-aanu
 one man outside stand-PROG-PRES
 ‘One (of the men) is standing outside.’
- (9) a. puratthu oru aal undu
 outside one man exists.PRES
 ‘There is a man outside.’
- b. *puratthu oru aal aanu
 outside one man is.PRES
 ‘There is a man outside.’
- c. oru aal puratthu undu
 one man outside exists.PRES
 ‘One man is outside.’/ ‘One (of the men) is outside.’
- d. oru aal puratthu aanu
 one man outside is.PRES
 ‘One (of the men) is outside.’

Appendix B

On the choice of *-u* or *-i*

One might ask why some verbs use *-u* as the past tense main verb forms/Conjunctive Participle forms while other verbs use *-i* in these forms. Could this choice be phonologically conditioned? Past exploration of this question has included work such as Kunjan Pillai (1965), Wickremasinghe & Menon (1932), Sekhar & Glazov (1961), Asher (1969), Prabodhachandran Nayar (1972) and Valentine (1976). The general assumption in these works is that the past tense morphology is composed of either *-i* or a consonant plus *-u*. Probably the reason for this assumption that the consonant is part of the past tense marker when *-u* is used can be explained as follows. Generally, verbs with a past in *-i* do not have any change between the past and non-past stems, for example, *ezhuth-um* ‘will write’ and *ezhuth-i* ‘wrote’, while those with a past in *-u* do have a change between the past and non-past stems, for example *keelk-um* ‘will hear’ and *kett-u* ‘heard’ or *sneehikk-um* ‘will love’ and *sneehicch-u* ‘loved.’ However, there are exceptions for forms with *-i* where a stem change does occur such as *poo-k-um* ‘will go’ and its past form *poo-y-i* ‘went’.

In any case, we do not want to make the assumption that the consonant involved in the stem change is part of the past tense morpheme, even though this has generally been assumed in the Dravidian literature. This is because the past tense stem is always what is used in Conjunctive Participle forms, which chapter 4 section 3 showed do not have to have past tense interpretations; in fact, as was shown in chapter 4, some of these forms can have present or future interpretations. This suggests that,

whatever the cause of the change in the stem, the change in the stem is semantically vacuous.

Abandoning the position that the consonant is part of the past tense marker in modern Malayalam¹ might also prove helpful for future phonological explorations of the change in the stem. As Asher & Kumari (1997) note "Other descriptions have sought to make explicit what in Kunjan Pillai is only implicit, and so provide rules which, where possible, allow the prediction of a past tense form from a statement of the phonology of the stem. All accounts agree that it is not possible to move beyond the two major groups proposed by Kunjan Pillai. This is because there are pairs of verb roots which are phonologically similar, but of which one has past tense in *i* and the other in consonant plus *-u*" p317. In other words, thus far, no one has found a way to explain why a given verb marks the past tense via using a consonant plus *u* versus just simply using *i*. I will leave it to future work in phonology to explain how and why the sound change occurs in the stem form.

¹Generally, following Kunjan Pillai (1965), it is assumed that historically, the consonant was a voiceless dental stop, and most of the previous work has assumed that this is the underlying representation for all of the other consonants one finds preceding the *u* past tense marker.

Bibliography

- Abney, S. (1987). *The English Noun Phrase in its Sentential Aspect*. PhD thesis, Massachusetts Institute of Technology.
- Aboh, E. O. (2009). Clause structure and verb series. *Linguistic Inquiry*, 40(1):1–33.
- Aboh, E. O. (2015). *The Emergence of hybrid grammars: Language contact and change*. Cambridge University Press.
- Aboh, E. O. (2016). "the emergence of svc". Slides from guest lecture at MIT. This is a full MISC entry.
- Abusch, D. (1991). The present under past as de re interpretation. In *The Proceedings of the Tenth West Coast Conference on Formal Linguistics*, pages 1–12.
- Adger, D. (2003). *Core syntax: A minimalist approach*, volume 33. Oxford University Press Oxford.
- Aikhenvald, A. and Dixon, R. M. W. (2006). *Serial verb constructions: A cross-linguistic typology*, volume 2. Oxford University Press on Demand.
- Aloni, M. et al. (2000). Conceptual covers in dynamic semantics. *Logic, Language and Computation*, 3.
- Altshuler, D. and Schwarzschild, R. (2012). Moment of change, cessation implicatures and simultaneous readings. In *Proceedings of Sinn und Bedeutung*, volume 17, pages 45–62.
- Altshuler, D. and Schwarzschild, R. (2013). Correlating cessation with double access. In *Proceedings of the 19th Amsterdam Colloquium*, pages 43–50.
- Amritavalli, R. (2014). Separating tense and finiteness: anchoring in dravidian. *Natural Language & Linguistic Theory*, 32(1):283–306.
- Amritavalli, R. and Jayaseelan, K. (2005). Finiteness and negation in dravidian. *The Oxford handbook of comparative syntax*, pages 178–220.
- Anandan, K. N. (1985). Predicate nominals in english and malayalam. *M. Litt. diss.*, Central Institute of English and Foreign Languages, Hyderabad.
- Arslan-Kechriotis, Z. C. (2006). perfectin turkish. *Turkic Languages*, 10(2):246–271.

- Asher, R. E. and Kumari, T. (1997). *Malayalam*. Psychology Press.
- Babu, M. H. and Madhavan, P. (2003). The two lives of-unnu in malayalam: A response to amritavalli and jayaseelan.
- Baker, M. (1985). The mirror principle and morphosyntactic explanation. *Linguistic inquiry*, 16(3):373–415.
- Baker, M. C. (2003). *Lexical categories: Verbs, nouns and adjectives*, volume 102. Cambridge University Press.
- Baker, M. C. (2008). *The syntax of agreement and concord*, volume 115. Cambridge University Press.
- Baker, M. C. (2011). Degrees of nominalization: Clause-like constituents in sakha. *Lingua*, 121(7):1164–1193.
- Basu, D. and Wilbur, R. (2010). Complex predicates in bangla: An event-based analysis. *Rice Working Papers in Linguistics*, 2.
- Beck, S. and von Stechow, A. (2015). Events, times and worlds-an lf architecture. *Situationsargumente im Nominalbereich. Linguistische Arbeiten Bd 562*.
- Benmamoun, E. (2000). *The feature structure of functional categories: A comparative study of Arabic dialects*. Oxford University Press.
- Bittner, M. (2005). Future discourse in a tenseless language. *Journal of Semantics*, 22(4):339–387.
- Bjorkman, B. A. M. (2011). *BE-ing default: The morphosyntax of auxiliaries*. PhD thesis, Massachusetts Institute of Technology.
- Bjorkman, B. A. M. (under revision). Verbal inflection and overflow auxiliaries. *Manuscript Queens University*.
- Bobaljik, J. D. (1995). *Morphosyntax: The syntax of verbal inflection*. PhD thesis, Massachusetts Institute of Technology.
- Bochnak, M. R. and Klecha, P. (2015a). Temporal remoteness and vagueness in past time reference in luganda. In *Proceedings of 45th annual conference on African linguistics (ACAL)*.
- Bochnak, M. R. and Klecha, P. (2015b). to appear. temporal remoteness and vagueness in past time reference in luganda. *Selected Proceedings of ACAL*, 45.
- Bohnemeyer, J. (2009). Temporal anaphora in a tenseless language. *The expression of time in language*, pages 83–128.
- Bohnemeyer, J. and Swift, M. (2004). Event realization and default aspect. *Linguistics and Philosophy*, 27(3):263–296.

- Borsley, R. D. and Kornfilt, J. (2000). Mixed extended projections. *Syntax and Semantics*, 32:101–131.
- Bošković, Ž. (2012). On nps and clauses. *Discourse and grammar: From sentence types to lexical categories*, pages 179–242.
- Butt, M. (1995). *The structure of complex predicates in Urdu*. Center for the Study of Language (CSLI).
- Butt, M. (2010). The light verb jungle: still hacking away. *Complex predicates in cross-linguistic perspective*, pages 48–78.
- Butt, M. and Lahiri, A. (2013). Diachronic pertinacity of light verbs. *Lingua*, 135:7–29.
- Butt, M. and Tantos, A. (2004). Verbal semantics via petri nets. In *On-Line Proceedings of the LFG04 Conference*.
- Cable, S. (2013). Beyond the past, present, and future: towards the semantics of ‘graded tense’ in gīkūyū. *Natural Language Semantics*, pages 219–276.
- Caldwell, R. (1856). *A Comparative Grammar of the Dravidian or South-Indian Family of Languages.* (Madras: University of Madras. 1961).
- Camacho, J. (2012). 22 ser and estar: The individual/stage-level distinction and aspectual predication. *The handbook of Hispanic linguistics*, 69:453.
- Camacho, J. (2015). What do spanish copulas have in common with tibetan evidentials? *New Perspectives on the Study of Ser and Estar*, 5:173.
- Cardinaletti, A. (2001). semi-lexical motion verbs in romance and germanic. Anna Cardinaletti and giuliana giusti. *Semi-lexical categories: The function of content words and the content of function words*, 59:371.
- Carlson, G. N. (2005). Generics, habituals and iteratives.
- Carstens, V. (2002). Antisymmetry and word order in serial constructions. *Language*, 78(1):3–50.
- Chomsky, N. (1957). *Syntactic structures*. Mouton.
- Chomsky, N. (1991). Some notes on the economy of derivation. *Principles and parameters in comparative grammar*, pages 417–54.
- Chomsky, N. (1998). *Minimalist inquiries: The framework*. Number 15. MIT Press.
- Chomsky, N. (2000). Minimalist inquiries: The framework. In *Step by step: Essays on minimalist syntax in honor of Howard Lasnik*, pages 89–155. Cambridge, MA: MIT Press.

- Comrie, B. (1976). The syntax of action nominals: A cross-language study. *Lingua*, 40(2-3):177–201.
- Copley, B. (2008). The plan’s the thing: Deconstructing futurate meanings. *Linguistic inquiry*, 39(2):261–274.
- Copley, B. (2009). *The semantics of the future*. Routledge.
- Damoiseau, R. (1982). Etudes de syntaxe comparée. *Universite d’Etat d’Haiti, Port-au-Prince*.
- Déchaine, R.-M. (1991). Bare sentences. In *Semantics and Linguistic Theory*, volume 1, pages 31–50.
- Den Dikken, M. and Hoekstra, E. (1997). Parasitic participles. *Linguistics*, 35(6):1057–1090.
- Diesing, M. (1992). Indefinites. *Linguistic Inquiry Monographs*, 20.
- Dowty, D. R. (1979). *Word Meaning and Montague Grammar: The Semantics of Verbs and Times in Generative Semantics and in Montague’s PTO*. Reidel.
- Embick, D. and Noyer, R. (2001). Movement operations after syntax. *Linguistic inquiry*, 32(4):555–595.
- Fintel, K. v. and Heim, I. (2011). Lecture notes in intensional semantics, ms.
- Freeze, R. (1992). Existentials and other locatives. *Language*, pages 553–595.
- Frohnmeier, L. J. (1913). *A progressive grammar of the Malayalam language for Europeans*. Basel Mission Book and Tract Depository.
- Gopalakrishnan, D. (1985). *Verb Sequences in Malayalam*. PhD thesis, Jawaharlal Nehru University, New Delhi.
- Haegeman, L. and Lohndal, T. (2010). Negative concord and (multiple) agree: A case study of west flemish. *Linguistic Inquiry*, 41(2):181–211.
- Hale, K. (1986). Notes on world view and semantic categories: Some warlpiri examples. *Features and projections*, 25:233–254.
- Halle, M. and Marantz, A. (1993). Distributed morphology and the pieces of inflection.
- Halle, M. and Marantz, A. (1994). Some key features of distributed morphology. *MIT working papers in linguistics*, 21(275):88.
- Hany Babu, M. (1997). *The syntax of functional categories*. PhD thesis, CIEFL, Hyderabad.
- Hany Babu, M. (2006). Genericity, quantification, and modality: The many faces of -um and -unnu in malayalam. In *Semantics Archive*, pages 1–24.

- Haspelmath, M. (1994). Passive participles across languages. *Voice: Form and function*, 27.
- Hayashi, M. (2011). *The structure of multiple tenses in Inuktitut*. PhD thesis, University of Toronto.
- Hayashi, M. and Oshima, D. Y. (2015). How multiple past tenses divide the labor: The case of south baffin inuktitut. *Linguistics*, 53(4):773–808.
- Hicks, G. (2009). *The derivation of anaphoric relations*, volume 139. John Benjamins Publishing.
- Hook, P. and Pardeshi, P. (2006). Are vector verbs eternal? In *11th Biennial Rice Linguistics Symposium: Intertheoretical Approaches to Complex Verb Constructions*.
- Iatridou, S., Anagnostopoulou, E., and Izvorski, R. (2001). Observations about the form and meaning of the perfect. *Current Studies in Linguistics Series*, 36:189–238.
- Inoue, K. An analysis of the english present perfect. *Linguistics*, 18.
- Jayaseelan, K. (1984). Control in some sentential adjuncts of malayalam. In *Annual Meeting of the Berkeley Linguistics Society*, volume 10, pages 623–633.
- Jayaseelan, K. (2004). The serial verb construction in malayalam. In *Clause structure in South Asian languages*, pages 67–91. Springer.
- Jayaseelan, K. (2014). Coordination, relativization and finiteness in dravidian. *Natural Language & Linguistic Theory*, 32(1):191–211.
- Jayaseelan, K. A. (2001). Ip-internal topic and focus phrases. *Studia Linguistica*, 55(1):39–75.
- John, A. P. (1987). *The semantics of modality: A study based on Malayalam and English*. Dravidian Linguistics Association.
- Kamp, H. and Reyle, U. (1993). From discourse to logic; an introduction to modeltheoretic semantics of natural language, formal logic and drt.
- Kang, J. (2014). *On the absence of TP and its consequences: Evidence from Korean*. PhD thesis, University of Connecticut.
- Kayne, R. S. (1994). *The antisymmetry of syntax*. mit Press.
- Klein, W. (1992). The present perfect puzzle. *Language*, pages 525–552.
- Klein, W. (1994). *Time in language*. Psychology Press.
- Koptjevskaja-Tamm, M. (1993). Nominalizations routledge. *London and New York*.

- Kratzer, A. (1998). More structural analogies between pronouns and tenses. In *Semantics and linguistic theory*, volume 8, pages 92–110.
- Kratzer, A. and Heim, I. (1998). *Semantics in generative grammar*. Blackwell.
- Krifka, M., Pelletier, F. J., Carlson, G. N., Chierchia, G., Link, G., and Ter Meulen, A. (1995). Introduction to genericity. *The generic book*, pages 1–124.
- Kusumoto, K. (1999). *Tense in embedded contexts*, Department of Linguistics, University of Massachusetts at Amherst. PhD thesis, Ph. D. dissertation.
- Lasnik, H. (1990). Restricting the theory of transformations: A case study. In *Essays on restrictiveness and learnability*, pages 125–145. Springer.
- Lin, J.-W. (2003). Temporal reference in mandarin chinese. *Journal of East Asian Linguistics*, 12(2):259–311.
- Lin, J.-W. (2006). Time in a language without tense: The case of chinese. *Journal of Semantics*, 23(1):1–53.
- Lin, J.-W. (2010). A tenseless analysis of mandarin chinese revisited: A response to sybesma 2007. *Linguistic Inquiry*, 41(2):305–329.
- Madhavan, P. (2006). A parser’s paradox: Reflections on malayalam verb morphology.
- Mathew, R. (2007). Simply malayalam participials. *CONSOLE XIV*.
- Matthewson, L. (2006). Temporal semantics in a superficially tenseless language. *Linguistics and Philosophy*, 29(6):673–713.
- McCoard, R. W. (1978). *The English perfect: Tense-choice and pragmatic inferences*. Elsevier Science Ltd.
- McFadden, T. and Sundaresan, S. (2014). Finiteness in south asian languages: an introduction. *Natural Language & Linguistic Theory*, 32(1):1–27.
- Menon, M. (2008). A cartography of definiteness. Master’s thesis, English and Foreign Languages University.
- Menon, M. (2011). Revisiting finiteness: The need for tense in malayalam. *FISAL: Tromsø*.
- Menon, M. (2016). *Building Adjectival Meaning without Adjectives*. PhD thesis, PhD Dissertation, University of Southern California.
- Menon, M. and Pancheva, R. (2014). The grammatical life of property concept roots in malayalam. In *Proceedings of Sinn und Bedeutung*, volume 18, pages 289–302.
- Merchant, J. (2011). Aleut case matters. *Pragmatics and autolexical grammar: In honor of Jerry Sadock*, 176:193.

- Mohanan, T. and Mohanan, K. P. (1999). Two forms of 'be' in malayalam. In *Proceedings of the LFG99 Conference. Stanford, CA: CSLI Publications. University of Manchester, Manchester, UK.*
- Mucha, A. (2012). Temporal reference in a genuinely tenseless language: The case of hausa. In *Semantics and Linguistic Theory*, volume 22, pages 188–207.
- Mucha, A. (2013). Temporal interpretation in hausa. *Linguistics and philosophy*, 36(5):371–415.
- Mucha, A. (2015). *Temporal interpretation and cross-linguistic variation*. PhD thesis, PhD thesis, University of Potsdam, Potsdam, Germany.
- Mucha, A. (2017). Past interpretation and graded tense in medumba. *Natural Language Semantics*, 25(1):1–52.
- Mucha, A. and Fominyam, H. Z. (2017). (un-) restricting tense in awing. *Proceedings of Triple A*.
- Mufwene, S. S. (2001). *The ecology of language evolution*. Cambridge University Press.
- Mufwene, S. S. (2008). *Language evolution: Contact, competition and change*. Bloomsbury Publishing.
- Muskens, R. (1995). Tense and the logic of change. *AMSTERDAM STUDIES IN THE THEORY AND HISTORY OF LINGUISTIC SCIENCE SERIES 4*, pages 147–147.
- Nikolaeva, I. (2010). Typology of finiteness. *Language and Linguistics Compass*, 4(12):1176–1189.
- Ogihara, T. (1989). *Temporal Reference in English and Japanese*. PhD thesis, University of Texas, Austin.
- Pancheva, R. (2003). The aspectual makeup of perfect participles and the interpretations of the perfect* roumyana pancheva. *Perfect explorations*, 2:277.
- Pancheva, R. (2013). Cross-linguistic variation in the perfect from the perspective of the pts theory. Slides from the Workshop on Aspect at the 10th International Tbilisi Symposium on Language, Logic and Computation. This is a full MISC entry.
- Pancheva, R. and von Stechow, A. (2004). On the present perfect puzzle. In *PROCEEDINGS-NELS*, volume 34, pages 469–484.
- Parsons, T. (1990). *Events in the Semantics of English*, volume 5. Cambridge, Ma: MIT Press.

- Partee, B. H. (1973). Some structural analogies between tenses and pronouns in english. *The Journal of Philosophy*, 70(18):601–609.
- Patel-Grosz, P. (2016). On prohibition constructions. lecture handout. This is a full MISC entry.
- Paul, P. (2013). Malayalam ceyy-support and its relation to event and argument structure. In *Harvard Working Papers in Linguistics*.
- Payne, T. E. (1997). *Describing morphosyntax: A guide for field linguists*. Cambridge University Press.
- Peet, J. (1860). *A Grammar of the Malayalim Language*. CM Press.
- Pillai, S. K. (1965). *Malayalam lexicon: a comprehensive Malayalam–Malayalam–English dictionary on historical and philological principles*. University of Kerala.
- Pollock, J.-Y. (1989). Verb movement, universal grammar, and the structure of ip. *Linguistic inquiry*, 20(3):365–424.
- Prior, A. N. (1967). *Past, present and future*, volume 154. Clarendon Press Oxford.
- Pullum, G. K. (1990). Constraints on intransitive quasi-serial verb constructions in modern colloquial english. *Working Papers in Linguistics*, 39:218–239.
- Pylkkänen, L. (2008). *Introducing arguments*, volume 49. MIT press.
- Raja Raja Varma, A. (1917). *Keralapanineeyam*. Reprinted by the Sahitya Pravarthaka Cooperative Society and distributed by National Book Stall, Kottayam.
- Ramchand, G. C. (2008). *Verb meaning and the lexicon: A first phase syntax*, volume 116. Cambridge University Press.
- Raposo, E. (1987). Case theory and infl-to-comp: The inflected infinitive in european portuguese. *Linguistic inquiry*, 18(1):85–109.
- Reichenbach, H. (1947). The tenses of verbs. *Time: From Concept to Narrative Construct: a Reader*.
- Reuland, E. (2001). Anaphors, logophors and binding. *Long-distance reflexives*, pages 343–370.
- Ritter, E. and Wiltschko, M. (2005). Anchoring events to utterances without tense. In *Proceedings of WCCFL*, volume 24, pages 343–351.
- Ritter, E. and Wiltschko, M. (2014). The composition of infl. *Natural Language & Linguistic Theory*, 32(4):1331–1386.
- Rizzi, L. (1997). The fine structure of the left periphery.

- Rothstein, B. (2008). *The perfect time span: on the present perfect in German, Swedish and English*, volume 125. John Benjamins Publishing.
- Sauerland, U. (2002). The present tense is vacuous. *Snippets*, 6(11):12–13.
- Schlenker, P. (1999). *Propositional attitudes and indexicality: a cross categorial approach*. PhD thesis, Massachusetts Institute of Technology.
- Shaer, B. (2003). Toward the tenseless analysis of a tenseless language. *Proceedings of SULA*, 2:139–156.
- Sigurdsson, H. A. (1991). Icelandic case-marked pro and the licensing of lexical arguments. *Natural Language & Linguistic Theory*, 9:327–363.
- Smith, C. S. (1991). The parameter of aspect, vol. 43 of studies in linguistics and philosophy.
- Smith, C. S. and Erbaugh, M. S. (2005). Temporal interpretation in mandarin chinese. *Linguistics*, 43(4):713–756.
- Smith, C. S., Perkins, E., and Fernald, T. (2003). Temporal interpretation in navajo. *Proceedings of SULA*, 2:175–192.
- Smith, C. S., Perkins, E. T., and Fernald, T. B. (2007). Time in navajo: Direct and indirect interpretation. *International Journal of American Linguistics*, 73(1):40–71.
- Stump, G. T. (1985). The semantic variability of free adjuncts and absolutes. In *The Semantic Variability of Absolute Constructions*, pages 1–40. Springer.
- Subbārāo, K. V. (2012). *South Asian languages: A syntactic typology*. Cambridge University Press.
- Swenson, A. (2016a). Nominalizing at different levels: How malayalam can help us better understand universal grammar. *Swanimam*, 2.
- Swenson, A. (2016b). A temporal semantics for malayalam conjunctive participle constructions. *Proceedings of Formal Approaches to South Asian Languages*, 6.
- Swenson, A. (2017). The incompatibility of malayalam conjunctive participle constructions with multiple temporal adverbs and individual level predicates. *Proceedings of Triple A*, 3:111–125.
- Swenson, A., Aravind, A., and Marty, P. (2015). The expression of information structure in malayalam. *Swanimam*, 1.
- Thomas, G. (2014). The present tense is not vacuous. *Journal of Semantics*, 32(4):685–747.
- Tonhauser, J. (2011). The paraguayan guaraní future marker-ta: formal semantics and crosslinguistic comparison. *Tense across languages*, pages 207–232.

- Travis, L. D. (1984). *Parameters and effects of word order variation*. PhD thesis, MIT.
- Vendler, Z. (1957). Verbs and times. *The philosophical review*, pages 143–160.
- Welmers, B. F. and Welmers, W. E. (1968). Igbo: A learner’s dictionary.
- Wiltschko, M. and Ritter, E. (2010). The composition of infl. an exploration of tense, tenseless languages and tenseless constructions. *Manuscript, University of British Columbia*.
- Wurmbrand, S. (2003). *Infinitives: Restructuring and Clause Structure*. Mouton de Gruyter.
- Wurmbrand, S. (2011). Reverse agree. *Lecture Notes*. Retrieved from: <http://wurmbrand.uconn.edu/Papers/Agree-and-Merge.pdf>.
- Zeijlstra, H. (2008). Negative concord is syntactic agreement. *Ms., University of Amsterdam*, 5:113.
- Zeijlstra, H. (2010). There is only one way to agree. Talk given at GLOW 33, Wroclaw, Poland.
- Zwicky, A. M. (1969). Phonological constraints in syntactic descriptions. *Research on Language & Social Interaction*, 1(3):411–463.