

# The ups and downs of head displacement

Karlos Arregi (The University of Chicago) & Asia Pietraszko (University of Rochester)

28 August 2019

**Abstract:** We propose a theory of head displacement that replaces traditional Head Movement and Lowering with a single syntactic operation of Generalized Head Movement. We argue that upward and downward head displacement have the same syntactic properties: cyclicity, Mirror-Principle effects and blocking in the same syntactic configurations. We also study the interaction of head displacement and other syntactic operations arguing that claimed differences between upward and downward displacement are either spurious or follow directly from our account. Finally, we show that our theory correctly predicts the attested crosslinguistic variation in verb and inflection doubling in predicate clefts.

**Keywords:** head displacement, Mirror Principle, VP ellipsis, *do*-support, predicate clefts

## 1 Introduction

The status of displacement operations that specifically target heads has been the focus of hotly-contested debate. While some authors have highlighted formal similarities with phrasal movement (i.a. Koopman 1984, Travis 1984, Baker 1988, Lema and Rivero 1990, Rizzi 1990, Koopman and Szabolcsi 2000, Matushansky 2006, Vicente 2007, Roberts 2010, Harizanov and Gribanova 2018, Preminger 2019), others have argued that at least some cases of head displacement are not the result of the same type of process as phrasal movement (i.a. Chomsky 2001, Hale and Keyser 2002, Harley 2004, Platzack 2013, Barrie 2017, Harizanov and Gribanova 2018). A related question is whether the crosslinguistic variety in the typology of head displacements points to a unified account or a division of labor into separate processes. A specific version of the latter hypothesis is that, while upward displacement is syntactic Head Movement, downward displacement is postsyntactic (PF) Merger or Lowering (Halle and Marantz 1993:132–138, Bobaljik 1995:57–109, and Embick and Noyer 2001, based on ideas in Lasnik 1981 and Marantz 1984). This separation, in turn, allows the assimilation of Head Movement to phrasal movement, at least in the sense that the resulting theory is one in which syntactic displacement is always upward.

We propose that upward and downward head displacement are the surface manifestations of a single syntactic operation of *Generalized Head Movement* (GenHM) that is distinct from phrasal movement (Move or Internal Merge). This unification has precedents in the theory of Minimalist Grammars (Stabler 2001), and in Harizanov and Gribanova 2018, and is one of the defining features of Mirror Theory (Brody 2000, Adger, Harbour, and Watkins 2009, Svenonius 2016). However, our specific implementation, as laid out in section 2, is different from those works, and is based on the idea that head displacement involves manipulation of specific parts of the feature content of syntactic heads. In this specific sense, head displacement in this analysis has commonalities with agreement, and has its precedents in Stabler 2001, Hale and Keyser 2002, Harley 2004, and Barrie 2017.

We provide several arguments for the unification of upward and downward head displacement proposed here. First, we argue in section 3 that the two types of head displacement have the same syntactic properties: they are both cyclic and yield Mirror Principle effects, feed upward

head displacement, and are blocked in the same configurations. Second, we study the interaction between head displacement and other syntactic operations, concentrating on those that have been claimed to argue for dissociating upward and downward head displacement. Our specific focus is *do*-support, and we argue in section 4 that claimed differences between upward and downward head displacement in this domain are either spurious or follow directly from our account.

GenHM unifies upward and downward head displacement by generating a single complex head associated with all terminal nodes related by the operation. Postsyntactic principles determine in which syntactic position the complex head is pronounced, yielding upward or downward displacement. This predicts that head displacement can in some cases result in multiple overt occurrences of the same complex head. Section 5 provides a final argument for GenHM based on V(P) fronting crosslinguistically, in which, we claim, verb doubling involves fronting of a fully inflected verb, not a bare verb, as in previous accounts.

## 2 Generalized Head Movement

In this section, we propose a novel operation of Generalized Head Movement that unifies different types of head displacement and makes the predictions outlined in the introduction. The analysis is partly based on ideas about the mechanisms behind head displacement proposed in Hale and Keyser 2002 and Harley 2004, to which we now turn.

Hale and Keyser (2002) and Harley (2004) propose to replace Head Movement with *Conflation*, an operation that, instead of moving (or copying) an entire head, copies a subset of its featural content (a different proposal along these lines is also made in Barrie 2017). More precisely, the copied features are those relevant to PF interpretation – the *phonological signature* (p-sig) of the head (Hale and Keyser 2002:62). Conflation applies when a head X is merged with its complement YP, and copies the p-sig of Y onto X. As a result, X’s new p-sig is a complex containing the original p-sigs of both X and Y.<sup>1</sup> Similarly, Generalized Head Movement manipulates only part of the contents of heads – the content relevant to Spellout. Unlike Conflation, in which the conflated feature appears only in the higher head, Generalized Head Movement creates such a cluster in both X and Y, implemented as feature sharing between those heads. The feature sharing approach has the advantage of unifying upward and downward head displacement, as we demonstrate below.

Our theory assumes a dichotomy of feature types: *syntactic features*, present on syntactic terminals, are involved in structure building (e.g. selection and movement-triggering features); *morphological features*, on the other hand, are those that underlie overt morphological contrasts (e.g. tense inflection or  $\varnothing$ -features). Unlike syntactic features, morphological features are bundled in a value of a larger M-feature. For example, a past tense T with first singular agreement features and an EPP feature is represented as in (1), where EPP, a syntactic feature, is located on the syntactic terminal, while the morphological features [Pst] and [1sg] are in the value of M. Exactly what morphological features are present on a head will be largely irrelevant in the discussion of head displacement. Therefore, we will abbreviate the value of M as follows: for any syntactic terminal X,  $X_m$  is the set of X’s morphological features.

---

<sup>1</sup>Head displacement in the framework of Minimalist Grammars (Stabler 2001) is very similar to Conflation in this respect, and like our Generalized Head Movement, it accounts for both upward and downward head displacement.

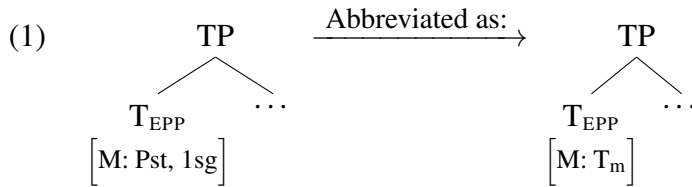

Another crucial difference between syntactic and morphological features concerns their spellout. We assume the realizational framework of Distributed Morphology (DM; Halle and Marantz 1993), with the addition that the sole target of Vocabulary Insertion (VI) is the value of M in each syntactic terminal. What is spelled out in (1), then, is the bundle of morphological features  $T_m$ .<sup>2</sup>

We define Generalized Head Movement (GenHM) as an operation that relates a head with the head of its complement by creating a shared M-value for both heads. The shared M-value is a structure containing the M-values of the input heads:<sup>3</sup>

(2) *Generalized Head Movement*

- a. Structural description: a syntactic object XP such that
  - the head X of XP contains a feature [hm] and an M-value  $X_m$ , and
  - the head Y of the complement of X contains an M-value  $Y_m$ .

- b. Structural change:

- delete [hm] in X,

- and replace  $X_m$  and  $Y_m$  with token identical .

The operation is triggered by a syntactic feature [hm] on the higher head (notated in our structures below with a superscripted *hm*) that is deleted after the operation applies. This formulation of GenHM is neutral with respect to linear order: X may precede or follow its complement YP, and the output M-value is a structure headed by either the leftmost or rightmost daughter. We adopt the standard assumption that linear order is determined by (potentially language- or item-specific) principles of postsyntactic linearization, which will not play any role in our analysis. In the particular case in which X precedes YP and  $Y_m$  precedes  $X_m$ , GenHM is represented as in (3a). We often use abbreviated representations involving brackets, in which case we represent GenHM as in (3b).

<sup>2</sup>The value of M in our theory resembles the p-signature of Hale and Keyser 2002 in that it comprises features relevant for pronunciation. A more detailed comparison is difficult as the notion of p-signature is not defined in detail in previous work. While Hale and Keyser (2002) tentatively take it to be the phonological form of a head, Harley (2004) points out this characterization is incompatible with a realizational theory of morphology. The value of M in the present theory is defined as a set of morphological features and thus is immediately implementable in the realizational framework of DM.

<sup>3</sup>The statement “A and B share feature F” refers to the following representation: A[F<sub>1</sub>]... B[F<sub>1</sub>], where the numeral subscript marks token identity.

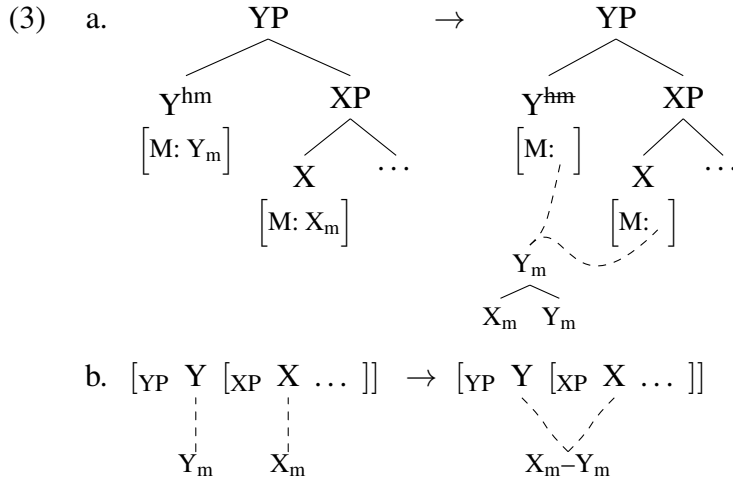

GenHM thus creates a new object that has the internal structure of a complex head (an *M-word* in Embick and Noyer’s (2001) sense). Unlike previous accounts, this complex head is the shared M-value of the syntactic terminals related by GenHM. For ease of exposition, we refer to the terminal nodes in this complex head as *morphological terminals*, to distinguish them from the syntactic terminals whose M-values they are part of. Within this complex head, VI applies to each morphological terminal in a bottom up fashion, as standardly assumed in DM (Bobaljik 2000, Embick 2010).

The newly created M-value is a single syntactic object associated with two (or more) syntactic terminals. In this respect, we draw a parallel with feature-sharing approaches to agreement, in which valuation is replaced by the notion of feature sharing (Pollard and Sag 1994, Brody 1997, Frampton and Gutmann 2000, Pesetsky and Torrego 2007). An important consequence of this implementation is the fact that the output of GenHM is neutral between upward and downward displacement. As we discuss below, the output M-value can be pronounced in either position, determined by postsyntactic spellout rules. A sequence of heads which share a single M-value will from now on be referred to as a *head chain*. It is crucial to note that thus defined GenHM involves no *movement* in the standard understanding of the term, i.e. as Internal Merge. The surface effect of displacement of features from one syntactic terminal to another is due to a different operation, GenHM, which has little in common with Internal Merge and, instead, resembles agreement (under the feature sharing approach). As such, GenHM is not burdened with some familiar issues with traditional head movement, such as the violation of the Extension Condition.

Another property of GenHM is that further instances of the operation extend the head chain and result in sharing of an M-value by more than two heads. In (4), the output of (3a) is merged with another head that triggers GenHM,  $Z^{hm}$ . The newly created M-value is now shared across the extended head chain that includes Z, Y, and X.

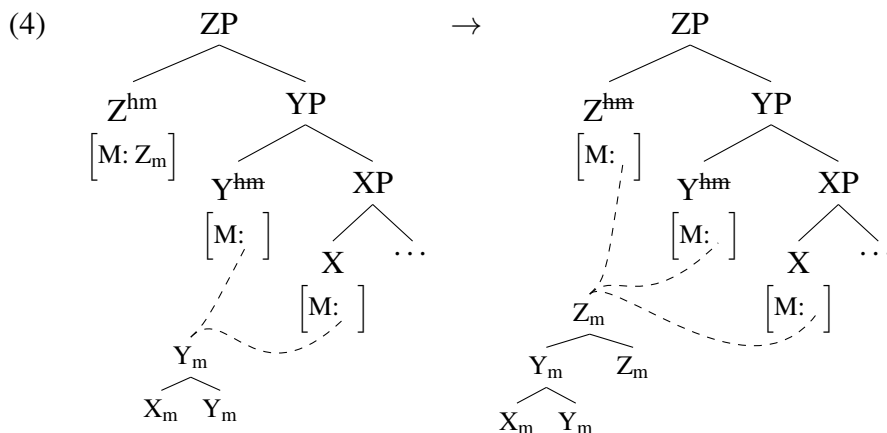

As should be clear from (2) and the representation in (4), GenHM is defined in a way that prevents Head Movement Constraint (HMC) violations (GenHM only applies to syntactic terminals in a head-to-head-of-complement relation) and excorporation (as it targets entire M-values), and as such, it derives Mirror Principle effects (Travis 1984, Baker 1985, 1988). Although Mirror-Principle violations are attested, they are relatively rare, and following a lot of previous work on the topic, we adopt the view that they are due to postsyntactic operations such as merger (Embick and Noyer 2001, Arregi and Nevins 2012, Harley 2013).<sup>4</sup> We present an analysis of English contracted negation along these lines in subsection 4.1.

The complex head created by GenHM is pronounced in a position occupied by one of the syntactic terminals it is associated with. Pronunciation in the highest position<sup>5</sup> gives the effect of upward displacement (traditional Head Movement); pronunciation in the lowest position yields downward displacement (cf. Lowering). We implement this aspect of the account in terms of a diacritic syntactic feature: as a lexical property, some syntactic terminals are strong ( $X^*$ ), while others are weak.<sup>6</sup> This feature governs the application of *Head Chain Pronunciation* (5), which we assume is a component of postsyntactic linearization.<sup>7</sup>

(5) *Head Chain Pronunciation*<sup>8</sup>

Delink all positions in a head chain except:

- a. the highest strong position, if any;
- b. otherwise, the highest position.

We hypothesize that strength is a privative feature, so that strong lexical items are featurally marked with respect to weak ones. This is reflected both in our notation (strong  $X^*$  vs. weak  $X$ ), and in

<sup>4</sup>For other views on these issues, see Julien 2002, Myler 2017, Skinner 2009.

<sup>5</sup>In the rest of this paper, we will use the terms *syntactic terminal* and *position* interchangeably.

<sup>6</sup>The strong/weak terminology should not be confused with strong and weak features of the Minimalist framework, where they are linked to overt vs. covert movement, respectively (Chomsky 1993).

<sup>7</sup>This implementation has clear parallels in Mirror Theory (Brody 2000). More specifically, our strong diacritic feature ( $X^*$ ) is similar to Svenonius's (2016) @ feature.

<sup>8</sup>Head Chain Pronunciation is not a subcase of Chain Reduction (Nunes 1995) or any other mechanism that deletes movement copies. As discussed above, GenHM is not an operation that creates (type identical) copies (unlike phrasal movement in its copy-and-delete implementation). Rather, it results in sharing of a *token-identical* M-value. For this reason, mechanisms deleting copies are not applicable to head chains created by GenHM. We discuss copy deletion in phrasal movement in sections 4.1, 4.3 and 5.

the fact that Head Chain Pronunciation only makes specific reference to strong heads, not weak ones. We discuss some potential consequences of the markedness of strong features at the end of subsection 4.3.

The parametrization induced by strength can be illustrated by contrasting the behavior of finite lexical (nonauxiliary) verbs in French and English. While French finite verbs undergo upward displacement to T (6),<sup>9</sup> lexical finite verbs in English stay in situ, and surface with finite inflection because of downward displacement of T to V (7), as diagnosed, for instance, by the relative position of the finite verb with respect to adverbs adjoined to the left of VP (Chomsky 1957, Emonds 1970:211–226, 1978:65–68, Pollock 1989).<sup>10</sup>

- (6) Jean { \*souvent embrasse / embrasse souvent } Marie.  
 Jean often kisses / kisses often Marie  
 ‘Jean often kisses Marie.’ French (Pollock 1989:367)
- (7) Sue { often eats / \*eats often } fish.

These phenomena are often taken to illustrate two different kinds of operations: upward head displacement is an instance of syntactic Head Movement in the sense of Koopman 1984, Travis 1984, and Baker 1988, while downward displacement is postsyntactic (Halle and Marantz 1993:132–138, Bobaljik 1995:57–109, Embick and Noyer 2001).

In contrast, the two phenomena are instances of the same syntactic operation in the GenHM framework proposed here. In both languages, GenHM relates T and V, triggered by the feature [hm] on T and creating a complex M-value shared by both positions. Both T and V are weak in French, hence the finite verb is pronounced in the highest position (T) by (94b). The derivation in (8) shows the application of Head Chain Pronunciation which delinks the M-value from the V position, giving rise to upward head displacement.

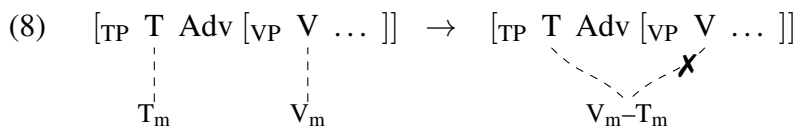

In English, T is weak as well, but lexical verbs are strong ( $V^*$ ). Consequently, the shared M-value is pronounced in the highest (and only) strong position in the chain, namely  $V^*$  (by (94a)), giving the appearance of downward displacement of T to V, as shown in (9).

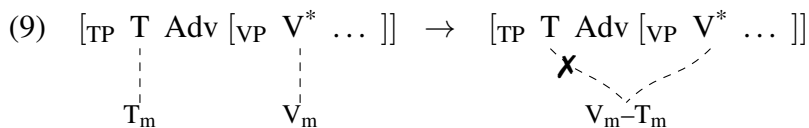

<sup>9</sup>We follow the Leipzig Glossing Rules (<https://www.eva.mpg.de/lingua/resources/glossing-rules.php>), with the addition of the abbreviations DSJ (disjoint), REL (relative subject prefix) and cardinal numerals denoting noun classes in the Ndebele examples.

<sup>10</sup>For the purposes of this paper, we remain agnostic as to the exact position of the finite verb in English, which could be V, v, or Voice, or even higher, but in any case, lower than T and adverbs such as *often*. For ease of exposition, we represent this position as V and to its phrasal projections as VP. If it turns out the verb is in a higher position, our analysis below should be modified to include further GenHM steps moving V to this higher position. Similar comments apply to our analysis of in Mainland Scandinavian in subsection 3.2.



The contrast between French and English disappears if the clause contains an auxiliary verb, as illustrated in (10) by relative order with negation. In the present account, the high position of auxiliaries in both languages is the consequence of Aux being a weak head in both. In the absence of strong positions in the chain, the shared M-value is pronounced in T, the highest position (11). The lexical verb in such structures is a trivial chain on its own (the auxiliary does not trigger GenHM). It must therefore be pronounced in V, whether V is strong (English) or weak (French).

- (10) a. He has **not** understood.  
 b. Il a **pas** compris.  
 he has not understood

‘He has not understood.’

French (Pollock 1989:370)

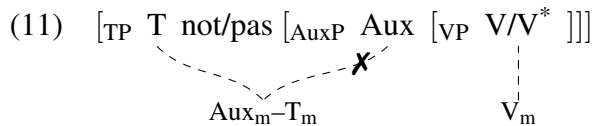

This French/English paradigm illustrates the basic workings of GenHM. In the following sections, we expand the empirical coverage of the analysis, and provide several arguments for the proposed unification of upward and downward head displacement. Before that, however, we highlight a few connections and differences between the proposed theory and other similar approaches to head displacement.

First, we briefly address another aspect of the debate on head displacement, namely, whether it is syntactic or postsyntactic (see Harizanov and Gribanova 2018, for a detailed overview). We propose that GenHM is a syntactic operation. The reason for the placement of GenHM in the syntax is its interaction with another syntactic operation, phrasal movement. As we will see in section 5, the observed interaction follows from cyclicity if GenHM is syntactic. A postsyntactic restatement of GenHM would require allowing some degree of interleaving syntax and PF – a claim previously made (Calabrese and Pescarini 2014, Martinović, to appear) but unnecessary here. Additionally, our theory leaves open the possibility that head displacement may feed LF and have semantic effects (Lechner 2007, Han et al. 2007, Szabolcsi 2011, Hartman 2011).<sup>11</sup> While none of the facts we discuss logically rule out a postsyntactic restatement of GenHM, it would come at a cost of complicating the interaction between the two modules. One firm stand we take in this debate is that upward and downward head displacement, being unified under GenHM, take place in the same derivational component, be it syntax or PF.

The GenHM view of head displacement bears some similarity to Mirror Theory, in which there is no movement operation per se that’s responsible for the displacement effect. In fact, Mirror Theory derives this effect with no syntactic operation whatsoever, reducing head displacement effects to the spellout of head-complement sequences. GenHM is different in that head displacement is due to an operation on morphological features that creates hierarchical objects. We think

<sup>11</sup>Harizanov and Gribanova 2018 propose that there are two types of head displacement – syntactic and postsyntactic. Unlike postsyntactic head displacement, syntactic head movement can have semantic effects, but crucially doesn’t have to. Semantic effects are thus only a weak diagnostic for the timing of head displacement – their absence is inconclusive, and only their presence diagnoses the syntactic type. Moreover, examples of putative semantic effects of head movement are scarce, which means that most instances of syntactic head movement are like postsyntactic ones in having no semantic consequences. For this reason, we do not use arguments from semantics for locating GenHM in a particular module. The argument for its syntactic nature comes from its interaction with other operations (section 5).

this implementation has desirable consequences. First, since GenHM creates complex heads, it is compatible with basic operations in Distributed Morphology, which make reference to terminal nodes, complex-heads and M-word locality. And second, the manipulation of only morphological features, e.g.  $\phi$  or tense features, allows for systematic exclusion of syntactic features from head displacement. It has been previously argued, for instance, that the ellipsis-licensing feature E is not transferred from one head to another, evidenced by the fact that ellipsis licensing is not fed by head displacement (LaCara 2016). We speculate that other features not transferred via head displacement include EPP and selectional features. It is beyond the scope of this paper to argue for a complete classification of features into syntactic and morphological but we consider the general hypothesis an advantage of our theory.

Despite the proposed unification of head raising and lowering, we do not claim that all head displacement phenomena fall under Generalized Head Movement. We agree with Harizanov and Gribanova (2018) that constructions traditionally unified under Head Movement may be of varied nature, involving different operations. Harizanov and Gribanova distinguish syntactic head movement, which is essentially phrasal movements of heads, from post-syntactic *amalgamation*, which unifies upward and downward displacement. GenHM resembles amalgamation in that it unifies raising and lowering and is strictly local, but it differs from amalgamation in a number of ways: as discussed above, it is a syntactic, not a post-syntactic operation, and it involves feature sharing rather than true displacement of nodes. It also differs from amalgamation in empirical coverage: it derives the Mirror Principle (section 3.1), it uniformly accounts for English and MSc T-to-V lowering (section 4.1) and it derives both verb and inflection doubling in VP-fronting (section 5). We assume, following Harizanov and Gribanova 2018, that certain types of head displacement involve true movement, i.e. Internal Merge. Examples include constructions such as participle fronting, in which V is displaced non-locally across an auxiliary and other material (i.a. Lema and Rivero 1990, Embick and Izvorski 1997, Harizanov and Gribanova 2018). Crucially, such long-distance head displacement is a *movement* operation, much like phrasal movement<sup>12</sup> and unlike GenHM, and we don't discuss it further in this paper.<sup>13</sup> Finally, heads can also be manipulated by post-syntactic operations, such as merger and Local Dislocation (Embick and Noyer 2001, Arregi and Nevins 2012). In section 4.1, we argue that one such rule, Negative Merger, is responsible for combining English verbs with clitic negation.

### 3 Evidence for the unification of upward and downward displacement

Upward head displacement has certain well-established syntactic properties, derivable from the HMC and the ban on excorporation. Since GenHM incorporates both conditions, downward head displacement is predicted to have those same syntactic properties. This section provides several direct arguments for GenHM based on these predictions.

#### 3.1 Successive cyclic downward displacement in Ndebele

In addition to deriving the Mirror Principle (Baker 1985) in upward head displacement, GenHM predicts that complex heads formed by downward displacement should also have a fully cyclic

---

<sup>12</sup>See Preminger 2019 for an account which captures why long distance movement typically involves whole phrases rather than heads, rendering long head movement relatively rare.

<sup>13</sup>See Appendix B for a derivation involving long head movement and GenHM.



internal structure. This section presents an argument that downward displacement indeed creates complex heads that obey the Mirror Principle.<sup>14</sup>

The argument comes from the formation of relative agreement (Rel-Agr) prefixes in Ndebele (Bantu, S44; Nguni group). In Ndebele, the subject agreement prefix on the verb has a special form in relative clauses (RCs). Compare the regular subject agreement prefix for class 7 in (12) with its counterpart in an RC-internal verb in (13).

- |      |   |      |  |
|------|---|------|--|
| (12) | Isi-lwane <b>si-</b> za-gijima.<br>7-lion 7SBJ-FUT-run<br><br>'The lion will run' | (13) | isi-lwane [ <sub>RC</sub> <b>esi-</b> za-gijima ]<br>7-lion [ <sub>RC</sub> 7REL-FUT-run ]<br><br>'the lion that will run' |
|------|---|------|--|

Building on previous work on Bantu (Khumalo 1992, Demuth and Harford 1999, Zeller 2004, Cheng 2006, Henderson 2006, 2013, Diercks 2010, Taraldsen 2010), and on the basis of morphosyntactic and phonological evidence, Pietraszko (2019) shows that the Ndebele relative prefix contains three morphemes: an associative linker, an augment vowel (a nominal prefix), and a regular subject agreement prefix.

As shown in (14), we adopt the standard view of the augment vowel as a determiner (von Staden 1973, Giusti 1997, de Dreu 2008, Visser 2008, among many others), and treat it as an exponent of D. Thus, a relative CP (whose head is null) is dominated by a DP shell headed by an augment vowel. This analysis of RCs is supported by the observation that all embedded clauses in the language are contained in a DP shell (see Pietraszko 2019 for evidence) and the fact that relative clauses attach to the head noun the same way other DPs (e.g. possessors) do – they are introduced by the *associative linker a-*.

- (14) [<sub>LnkP</sub> Lnk [<sub>DP</sub> D [<sub>CP</sub> C [<sub>TP</sub> T ... ]]]]  
linker 'a' augment ∅ Sbj-Agr

As an illustration, consider the Rel-Agr prefix of class 7 *esi-* in (13). It consists of three overt morphemes: the linker *a-* in Lnk, an augment vowel in D, and subject agreement in T. Notably, the augment always covaries with the RC-internal subject (rather than the relative head). Thus, D and T both covary with class 7 in (13), and have the exponents *i-* and *si-*, respectively. The resulting sequence of morphemes *a+i+si*, surfaces as *esi-* due to regular phonological processes (see below for details).

We argue that the formation of Rel-Agr prefixes in Ndebele is an instance of cyclic downward head displacement. GenHM applies bottom up to T, C, D and Lnk. T is the only strong position, which is where the resulting complex head is pronounced:

<sup>14</sup>The same predictions are made by Mirror Theory. For instance, Adger, Harbour, and Watkins's (2009) Mirror-Theoretic analysis of Kiowa accounts for the fact that complex verbal heads that are pronounced low have a Mirror-Principle obeying internal structure.



(19)	class	[	Lnk	[	D $\varphi$	[	C	T $\varphi$	]]]	→	REL
	1	a	u	u	→	[a	[u]]	→	o		
	9	a	i	i	→	[a	[i]]	→	e		
	7	a	i	si	→	[a	[isi]]	→	esi		
	11	a	u	lu	→	[a	[ulu]]	→	olu		

The order in which coalescence rules apply is determined by the internal structure of the complex head. Their application is cyclic – it targets the two most embedded components first and so on, as indicated by the bracketing in (19). Crucially, the surface form of Rel-Agr can be correctly derived by regular phonology only if the internal structure of the complex head obeys the Mirror Principle, as shown in (20) for class 9 Rel-Agr.

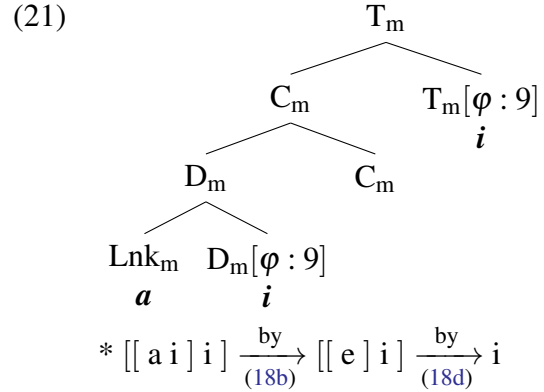
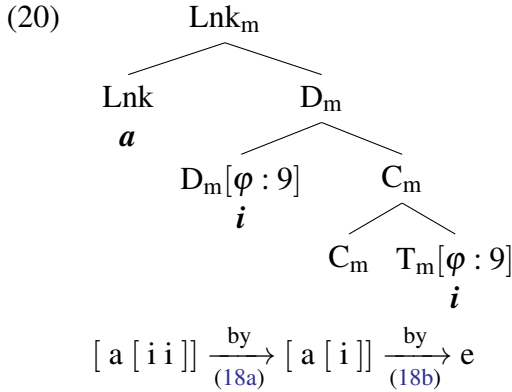

While the predicted structure derives the correct form *e* (20), the non-mirroring bracketing in (21) incorrectly predicts the form *i* for the class 9 Rel-Agr prefix.

We conclude that Rel-Agr prefixes in Ndebele are formed by cyclic downward displacement. They are complex heads whose internal structure is identical to the internal structure of complex heads created by upward displacement (they obey the Mirror Principle), but whose pronunciation is low. This is as predicted by GenHM, according to which upward and downward head displacement are the same syntactic process.

Before moving on, we briefly compare GenHM to Harizanov and Gribanova’s (2018) amalgamation, as both theories can achieve cyclic, MP-obeying lowering. Unlike GenHM, amalgamation does not derive the cyclicity of upward and downward displacement in a uniform way, as it does not unify them under a single operation. Raising is triggered by a [+M] feature on the lower head, while Lowering by [−M] on the higher head, as illustrated in (22-23). The [±M] feature is a lexical property of individual heads and is subject to cross-linguistic variation. (In the derivations below, a [±M] feature is no longer represented after the operation it triggers has applied).

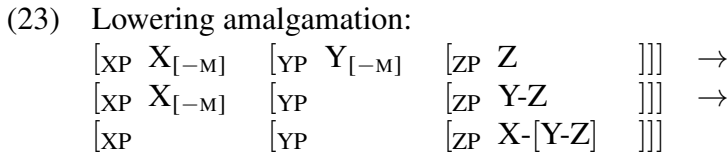
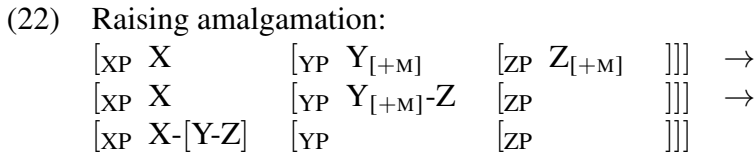

Assuming that amalgamation applies cyclically bottom up, the resulting complex heads obey the Mirror Principle, both in the raising and the lowering case. Note that in the lowering scenario, X lowers further down than the head of its complement. This is because the head of its complement, i.e. Y, was earlier lowered itself, rendering the complex head [Y-Z] the closest target. While this mechanism allows lowering to create Mirror-Principle-obeying complex heads, it equally allows ones which violate it:

(24) Amalgamation creating a MP-violating complex head:

$$\begin{array}{l} \begin{array}{l} [\text{XP } \text{X}_{[-\text{M}]} \\ [\text{XP } \text{X}_{[-\text{M}]}-\text{Y} \\ [\text{XP} \end{array} \quad \begin{array}{l} [\text{YP } \text{Y}_{[+\text{M}]} \\ [\text{YP} \\ [\text{YP} \end{array} \quad \begin{array}{l} [\text{ZP } \text{Z} \\ [\text{ZP } \text{Y} \\ [\text{ZP } [\text{X}-\text{Y}]-\text{Z} \end{array} \quad \begin{array}{l} ]]] \rightarrow \\ ]]] \rightarrow \\ ]]] \end{array} \end{array}$$

Thus, amalgamation and GenHM additionally differ in that the latter derives Mirror Principle effects, while the former merely allows them.

### 3.2 Downward displacement feeds upward displacement in Mainland Scandinavian

In this subsection, we explore the predictions of the account with respect to a head chain with structurally nonadjacent strong positions:

$$(25) \quad [\text{ZP } \text{Z}^{\text{hm},*} [\text{YP } \text{Y}^{\text{hm}} [\text{XP } \text{X}^* ]]]$$

Descriptively, this is a case of downward head displacement feeding upward head displacement: in the absence of Z, the result is downward displacement to the lowest position (X), but if Z is present, the complex head surfaces in the highest position (Z). Syntactically, upward displacement to the highest position is always possible, regardless of the directionality of the displacement relating the two lower heads. In the particular case in which Y first displaces downward to X, the surface effect is one in which nonadjacent positions seem to be related in a nonlocal or noncyclic way, yet each step involves an application of GenHM that is both cyclic and local, since at each step a head is related to the head of its complement, and GenHM in a lower part of the structure precedes GenHM in a higher part of the structure. We argue that this is precisely the case in V2 sentences in the North Germanic languages of Mainland Scandinavia (MSc; Danish, Norwegian, and Swedish). We exemplify the phenomenon throughout with examples from Danish.

The basic puzzle posed by V2 in MSc is that, although V moves to C in V2 contexts, there is no independent evidence for an intermediate step of this movement in T (i.a. [den Besten 1983](#), [Taraldsen 1985](#), [Holmberg 1986](#), [Platzack 1986](#), [Holmberg and Platzack 1995](#), [Vikner 1995](#)). First, V is in C in V2 contexts, as diagnosed by the position of the finite verb to the immediate left of the subject (26). Second, in non-V2 sentences, the position of the finite verb to the right of markers of the left edge of VP (e.g. adverbials) reveals that the former surfaces within VP (27).<sup>15</sup>

$$(26) \quad \begin{array}{l} \text{Om morgenen} \quad \mathbf{drikker} \quad [\text{TP } \text{Peter} [\text{VP } \text{ofte} \quad \text{kaffe} \quad ]] \\ \text{in the.morning drinks} \quad [\text{TP } \text{Peter} [\text{VP } \text{often} \quad \text{coffee} \quad ]] \end{array}$$

‘Peter often drinks coffee in the morning.’

Danish ([Vikner 1995:47](#))

<sup>15</sup>On the precise position of the finite verb in non-V2 contexts, see footnote 10. Unlike English, all verbs, including auxiliaries, surface in a low position in non-V2 contexts (see references cited above for evidence). Under the GenHM account presented below, this entails that auxiliaries are generated in strong head positions.

- (27) Vi ved at [TP Peter [VP ofte **drikker** kaffe om morgenen ]]  
 we know that [TP Peter [VP often drinks coffee in the.morning ]]

‘We know that Peter often drinks coffee in the morning.’ Danish (Vikner 1995:47)

This paradigm thus illustrates (25): the complex head surfaces in the highest (C) or lowest (V) position, but never in the intermediate position (T).

Previous Head-Movement-based analyses of this pattern sacrifice either cyclicity or locality. In Holmberg and Platzack 1995:49–50 and Vikner 1995:28–31, 133, V moves to T only if there is further movement to C: V does not move to T overtly in non-V2 contexts,<sup>16</sup> and in V2 sentences, V moves to C making an intermediate step in T enforced by locality (HMC). This is a non-cyclic account, in the sense that V-to-T movement is contingent on further movement from T to C, and thus does not solely depend on properties of V and T. On the other hand, Bobaljik (1995:322–328) and Harizanov and Gribanova (2018) preserve cyclicity, but propose that V moves to C directly, not constrained by the HMC.

In contrast to these analyses, GenHM allows for a derivation of this paradigm that is strictly cyclic and local, as it instantiates the abstract pattern in (25).<sup>17</sup> Both the highest (C) and lowest (V) head positions are strong, and the intermediate position (T) is weak.<sup>18</sup> In non-V2 contexts, C does not trigger GenHM, and only V\* and T are involved:

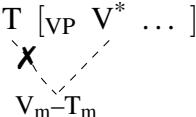
- (28) [TP T [VP V\* ... ]]  

Since V is the highest – in fact, the only – strong position, the complex head is spelled out within VP. A V2 derivation involves a further step of GenHM relating T and C\*:

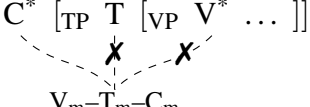
- (29) [CP C\* [TP T [VP V\* ... ]]]  

The highest strong position is C\*, which is where the complex head is spelled out. The surface effect is the appearance of downward displacement from T to V\* followed by upward displacement from V\* to C\* either in one long step or countercyclically stopping in T. However, each step in the syntactic derivation is local and cyclic: the first instance of GenHM relates T and V\*, and the second, C\* and T. The apparent nonlocality or noncyclicity of the derivation is due to the fact that

<sup>16</sup>In addition, V and T are related by either downward displacement or a lexicalist feature-checking operation and LF movement, along the lines of Chomsky 1993.

<sup>17</sup>In Authors (2018), we address two potential challenges to the claim that head displacement to C in MSc is strictly cyclic and local. Specifically, we argue that it does not display the behavior of clear cases of long head movement, such as participle fronting in Slavic (i.a. Lema and Rivero 1990, Embick and Izvorski 1997, Harizanov and Gribanova 2018). We also discuss an argument from Sailor (2009, 2018) based on the interaction between V2 and VP ellipsis. Our counterargument is summarized in subsection 4.3 below.

<sup>18</sup>The idea that the apparent locality or noncyclicity problems in V2 in MSc dissolve once we view this as a matter of determining the spellout positions of heads is due to Svenonius 2016:217–218.

the strong positions are not structurally adjacent.<sup>19</sup>

It is worth noting that GenHM affords a unified treatment of T-to-V lowering in Germanic languages: the account of MSc in (28) is identical to the derivation of its English counterpart (9).<sup>20</sup> English differs from MSc, however, in that English lexical verbs never surface in C. Instead, we observe *do*-support. In section 4.1, we derive this difference between MSc and English, at the same time maintaining a uniform treatment of T-to-V lowering in those languages.

### 3.3 Upward and downward displacement in Romance imperatives

The unification of upward and downward head displacement under GenHM predicts that both types of displacement are blocked in the same configurations. In this subsection, we test this prediction with Romance imperatives. In many Romance languages, the verb moves to C in positive imperatives, but this movement is blocked by negation, which forces the verb into a lower position. These different positions of the verb in imperatives correlate with differences in their inflectional exponence. We argue that in varieties of Vallader Romansh, a similar correlation holds, except that the head-displacement process that is blocked by negation is downward, not upward.

We first illustrate the correlation between verb position and inflection with Iberian Spanish second plural imperatives. In affirmative commands, the verb is inflected in an imperative-specific form, and object clitics follow the verb (i.e. they are enclitics):<sup>21</sup>

- (30) Llamad nos!  
call.IMP.2PL us

‘Call us!’

Iberian Spanish

The postverbal position of the clitic in imperatives is standardly taken to diagnose a high position for the verb, more specifically, C, contrasting with the low position of other finite forms, in which proclisis obtains (Rivero 1994, Rivero and Terzi 1995). In contrast, the verb in negative imperatives follows object clitics, and has a different inflectional form that is syncretic with the present subjunctive (notated here as IMP/PRS.SBJV):

- (31) No nos llaméis!  
not us call.IMP/PRS.SBJV.2PL

---

<sup>19</sup>As is generally the case in Germanic, the C that the verb associates with under V2 is systematically covert in MSc. This complementarity between V2 and overt C has been taken as an argument against a head-concatenation view of V2, as it predicts that, in at least some languages, the complementizer would be overt (Fanselow 2004, 2009). The specific prediction of a head-concatenation analysis (including ours) is that C should surface as an affix on the verb in some languages, and this is indeed what we find outside Germanic, such as in Dzamba, Shona (Demuth and Harford 1999), and Wolof (Russell 2006, Martinović 2015). We thus believe that it is an accident that C is systematically a null affix under V2 in Germanic. Furthermore, we do not know of any alternative to head concatenation that derives this fact in a systematic way. For instance, the reprojecting-movement account of head displacement in Fanselow 2004, 2009 can derive affixation structures, and thus predicts that V2 movement can result in affixation of an overt C to the verb. Similarly, the movement-to-specifier account suggested in Harizanov and Gribanova 2018 predicts that the attracting head could be an overt C (see Harizanov and Gribanova 2018:footnote 44 for relevant discussion).

<sup>20</sup>Harizanov and Gribanova (2018) derive T-to-V lowering in Danish via amalgamation, but treat English T-to-V lowering as a different type of operation (footnote 32).

<sup>21</sup>Throughout this subsection, we systematically represent Romance clitics as separate words, ignoring standard orthographic conventions. We also ignore the opening exclamation mark (;) in Spanish, to avoid confusion with markers of acceptability.



Following the accounts in [Rivero 1994](#), [Rivero and Terzi 1995](#), and [Zanuttini 1997](#), we assume that the preverbal position of the clitic indicates that negation blocks movement of the verb to C, and that the difference in inflectional form is closely correlated with position: in imperatives, C triggers the special exponence visible in affirmatives, but in negatives, the verb is not in a local configuration with C, which blocks allomorphy.<sup>22</sup> The form of the verb in negative imperatives is often syncretic with either the subjunctive (e.g. Spanish) or the infinitive (e.g. Italian), though, as we will see below, this syncretism is only partial in some Romance varieties.

Adapting the analyses cited above to the GenHM framework, we take positive imperatives to involve a GenHM relation between V, T, and C, and implement the blocking by negation in terms of a high  $\Sigma$  head ([Laka 1990](#)) that intervenes between C and T.<sup>23</sup> The single head chain in the affirmative is spelled out in the highest position (C), since no head is strong (32a). Regardless of the surface position of the complex head, the  $[V_m-T_m]$  complex is in a local configuration with  $C_m$  in the value of the shared M-feature, which triggers imperative-specific allomorphy. In negative imperatives (32b), C enters into a GenHM relation with  $\Sigma$ , leaving the  $[V_m-T_m]$  complex in T, since  $\Sigma$  itself does not trigger GenHM.<sup>24</sup>

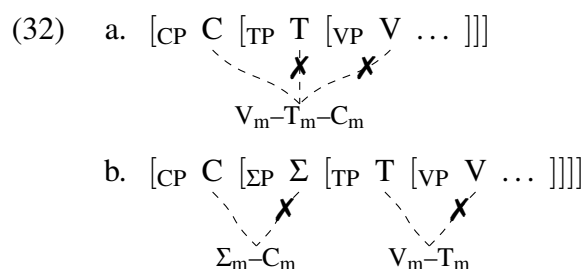

As  $[V_m-T_m]$  is not in a local configuration with  $C_m$  in (32b), the finite verb takes on a different inflectional form.

In the context of this analysis of the correlation between head displacement and inflectional form, the GenHM account makes the following prediction: if T is strong, the C-T relation in positive imperatives will be downward, that is, the finite verb will be spelled out in T instead of C, following object clitics. This prediction is borne out by some varieties of Vallader Romansh, which we illustrate here with the variety of Scuol.<sup>25</sup> The inflectional form of imperatives in this

<sup>22</sup>The tight correlation between imperative syntax and exponence in the works cited above is challenged in [Harris 1998](#), who nevertheless also adopts a similar analysis of the syntax of imperatives and its relation to inflectional exponence. See also [Romanello and Repetti 2014](#).

<sup>23</sup>We abstract away from intermediate projections and head positions between V, T, and C.

<sup>24</sup>We make the simplifying assumption that  $\Sigma$  is not present in positive imperatives, but this is not crucial for our analysis. If positive  $\Sigma$  were indeed present in (32a), it would be specified as [hm] (unlike its negative counterpart) and therefore be part of the head chain with V, T, and C.

<sup>25</sup>Vallader is the easternmost variety of Romansh in Switzerland ([Haiman and Benincà 1992](#), [Anderson 2016](#)). Other varieties of Vallader Romansh with the same patterns in imperatives include Sent and Müstair. The variety of Zernez is different, in that negative imperatives can have the same imperative-specific form as in affirmatives, with proclitics in both. This can be interpreted in different ways. It could be taken to be evidence that no relation with C is established (even in affirmatives), and that imperative-specific exponence is not due to allomorphy triggered by C. Perhaps more interestingly, the pattern might also be due downward displacement of C in imperatives that is not blocked by negation. See [Manzini and Savoia 2005:424–425](#) for relevant examples in all these varieties.

variety is different in affirmative (33) and negative (34) sentences, illustrated here with the second person plural.

(33) ans klɔ'mai  
 us call.IMP.2PL  
 ‘Call us!’

(34) nu ns klɔma'rai  
 not us call.IMP/INF.2PL  
 ‘Don’t call us!’

Scuol (Manzini and Savoia 2005:424)

While the second plural imperative has the inflectional suffix *-ai* specific to imperatives in the affirmative, the form used in the negative counterpart is different, as it involves a form that is partially syncretic with the infinitive (notated here as IMP/INF).<sup>26</sup> As in other Romance languages, we take this to be the result of a C-T relation in affirmatives (32a) that is blocked by intervening  $\Sigma$  in negatives (32b). However, as shown above, the verb surfaces in the same low position (T) in both, as evidenced by the fact that clitics are preverbal in both cases.<sup>27</sup> That is, imperatives in Scuol and other varieties of Vallader Romansh involve a relation with C that is blocked by negation (as diagnosed by verbal form), but this relation is one of downward, not upward, displacement (as diagnosed by clitic placement), due to the strength of (imperative) T in these varieties. In affirmative imperatives, the output of GenHM is (35), to be contrasted with this construction in other Romance languages (32a).

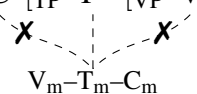
(35) [CP C [TP T\* [VP V ... ]]]  

In negative imperatives, T is also strong, but the resulting configuration is the same as in other Romance languages, shown in (32b): by being the top position in the lower head chain, a strong feature in T has no effect on where the complex head is pronounced.

To summarize this section, the unification of upward and downward head displacement afforded by GenHM finds support in the different ways in which these syntactic processes behave the same way: they are both cyclic and derive the same types of Mirror-Principle effects, both feed further upward head displacement, and both are blocked in the same configurations. In the next section, we discuss differences between upward and downward displacement, and how GenHM accounts for these.

#### 4 Directionality of head displacement and *do*-support crosslinguistically

A well-motivated difference between upward and downward displacement in English is that only the latter correlates with *do*-support. GenHM offers a novel way of looking at this difference in terms of the relation between syntactic operations and Spellout. In this section, we offer a detailed

<sup>26</sup>More specifically, the negative form is the same as the infinitive with the addition of the second person plural suffix *-ai* characteristic of imperatives in Vallader Romansh (Haiman and Benincà 1992:98–101).

<sup>27</sup>In second person singular imperatives, the verb can surface before or after the clitics (Manzini and Savoia 2005:424–425). This might indicate a featural difference in T between second person plural and singular imperatives: while T is obligatorily strong in the plural, as proposed above, it is optionally so in the singular. Exploring potential consequences of this hypothesis would take us far beyond the scope of the present paper.

analysis of this interaction, arguing that, while the correlation between downward displacement and *do*-support holds in some languages, it does not in others.<sup>28</sup> In subsections 4.1–4.2 we discuss *do*-support in contexts such as negation and subject-auxiliary inversion, and subsection 4.3 concentrates on *do*-support (as well as V stranding) under VP ellipsis. In all these contexts, we argue that *do*-support may indeed correlate with upward displacement.

#### 4.1 Directionality of displacement and *do*-support: An apparent correlation

We have seen that in English, auxiliaries undergo upward displacement to T, while lexical verbs trigger downward displacement from T. In this language, we find a correlation between this difference in the direction of displacement and the process known as *do*-support. Unlike upward displacement, downward displacement appears to be blocked in certain contexts (e.g. negation) and *do*-support applies instead. In the literature, this difference between English downward and upward displacement has been used as evidence that these are different types of operations, subject to different conditions. In this subsection, we provide an analysis of this correlation in English, based on the hypothesis that in certain languages with strong V heads, a head chain is split into two whenever certain elements intervene between members of the chain. These split chains are subject to special spellout conditions, which result in defective pronunciation of  $V_m$  in one of them as *do*. The analysis developed for English makes the prediction that the correlation between the direction of head displacement and *do*-support is spurious, and that it need not hold crosslinguistically. This prediction is shown to be correct in the next subsection.

The following examples illustrate the correlation in English. First, lexical verbs trigger downward displacement of T (section 2), and, accordingly, trigger *do*-support in the context of sentential negation (36a), verum focus (36b), and subject-auxiliary inversion (36c) (Chomsky 1957, Emonds 1970:208–226; on *do*-support in VP ellipsis and fronting, see subsection 4.3 and section 5 below.)

- (36) a. Sue {does not eat/doesn't eat/\*not eats/\*eats not} fish.  
 b. Sue {DOES (so) eat/\*so eats/\*eats so} fish.  
 c. Where {does Sue eat/\*Sue eats/\*eats Sue} fish?

Under *do*-support, the verb surfaces in a bare form in V, and T is pronounced in T (36a, b) or C (36c), along with the dummy verb *do*. On the other hand, auxiliary verbs undergo upward displacement to T (section 2), and do not trigger *do*-support in these contexts:

- (37) a. Sue {is not/isn't/\*does not be/\*doesn't be} eating fish.  
 b. Sue {IS (so)/\*DOES (so) be} eating fish.  
 c. Where {is Sue/\*does Sue be} eating fish?

As mentioned above, this English paradigm has been taken to diagnose an important difference between downward and upward displacement: the former is subject to stricter locality conditions (often stated in terms of linear adjacency) than the latter. More specifically, certain items such as *not* and subjects (in subject-auxiliary inversion contexts) disrupt locality between T and V, which blocks downward displacement, thereby triggering insertion of *do* in T (Chomsky 1957:61–72, Lasnik

---

<sup>28</sup>In appendix A, we discuss a different interaction, having to do with the relation between head displacement and phasehood.

1981:160–169, Halle and Marantz 1993:132–138, Bobaljik 1995:57–109).<sup>29</sup> None of these items block upward displacement (Head Movement), which is why English auxiliaries do not trigger *do*-support.

In the analysis of head displacement proposed here, this difference between downward and upward displacement must be couched in different terms. Since both are the result of the same syntactic operation, their differences cannot be the result of differences in the application of GenHM, but must be instead due to conditions on the *postsyntactic* realization of head chains, which is the locus of the difference between downward and upward displacement under this account. Our analysis below is thus based on the claim that GenHM does apply in *do*-support contexts, but (i) in these contexts, head chains containing V\* are split, and (ii) certain elements in the M-values of the resulting chains are exponed defectively. In a nutshell, *do* is the defective realization of the verb in the higher chain, and bare inflection in the lower chain is the defective realization of T in that chain.

Following the analyses mentioned above, especially Bobaljik 1995, we assume that what is special about a *do*-support-triggering context is the presence of a certain type of specifier intervening between syntactic terminals related by head displacement. However, unlike those previous works, we assume that the relevant notion of intervention is structural, not linear. In the case of sentential negation and verum focus, the intervener is in the specifier of  $\Sigma$ P,<sup>30</sup> which is realized by *not/n't*, *so*, or the covert counterpart of the latter (Pollock 1989:409–422, Bobaljik 1995:72–73).  $\Sigma$  itself has null realization and is part of the head chain relating V and T.<sup>31</sup>

Thus, the structure of (36a) after GenHM applies is as shown in (38a) (we use ‘Neg’ as the label of the category sentential negation is the exponent of, to distinguish it from  $\Sigma$ ).<sup>32</sup> Similarly, in cases of subject-auxiliary inversion (36c), GenHM relates V, T, and C across the subject in the specifier of TP, as schematized in (38b).

---

<sup>29</sup>Lowering of T in English is also assumed to be blocked by intervening sentence negation and inverted subjects in Embick and Noyer 2001:584–591, but this is not the immediate trigger of *do*-support in that analysis.

<sup>30</sup>Adapting Bobaljik 1995:76–78 to the present framework, a crucial distinction we make here is between specifiers such as *not* and adjuncts such as *often* (7), which do not trigger *do*-support. This, together with the fact that the intervener can be covert (in verum focus) leads us to adopt an account based on intervention, not linear adjacency.

<sup>31</sup>The claim that *not* is a specifier and not a head is challenged in Potsdam 1997, on the assumptions that (i) a VP can elide only if it is the complement of an overt head, and (ii) *not* licenses VP ellipsis in subjunctive clauses. Assumption (i) is, however, not compatible with current work on ellipsis. See, for instance, Merchant 2013, in which English VP ellipsis is licensed in the complement of Voice, which can be null. See also Bruening 2010:73–75 for arguments that *not* does not license VP ellipsis in subjunctives. Another possible argument for *not* being a head, due to a reviewer, is that, as a specifier, it would be phrasal and therefore frontable by negative inversion, which they claim is ungrammatical. The force of this argument is severely weakened by work showing that heads *can* participate in the same types of movement dependencies as phrases (i.a. Matushansky 2006, Landau 2006, Vicente 2007, Preminger 2019); if *not* cannot undergo negative inversion, this is not necessarily an argument for it being a head. Furthermore, we have found that negative inversion of *not* is grammatical for some speakers (though not all), especially if modified by an adverb: *Absolutely not would I ever recommend this company* (cf. its unfronted version *I would absolutely not ever recommend this company*). Finally, Barrie (2017), as an argument for an analysis of *not* as a head, claims that it cannot be modified. We take the fact that *absolutely not* can be fronted to be evidence that *not* does accept modifiers, which confirms its phrasal status.

<sup>32</sup>The derivation of verum focus sentences (36b) is the same. An additional complication is involved in sentences with contracted negation, discussed below.

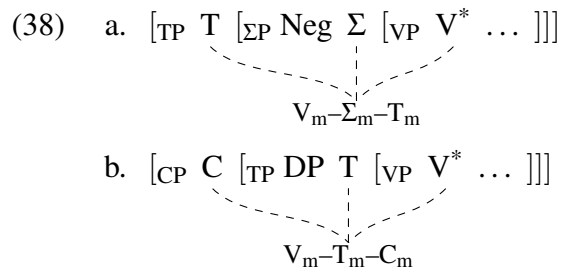

GenHM does apply in these contexts, just as it does when the verbal element is not strong. However, in English (and other languages discussed below), head chains with strong V are subject to *chain splitting* due to intervening specifiers (39).<sup>33</sup> The resulting chains are pronounced defectively because of an additional postsyntactic operation of *Orphan Assignment* (40).

(39) *Split-by-intervention*

In a head chain terminating in V\* such that a specifier marked [+P] intervenes<sup>34</sup> between the top of the chain and V\*, split the chain at V\*.

(40) *Orphan Assignment*

Assign [O] to morphological terminal X<sub>m</sub> in a head chain that does not contain the syntactic terminal X.<sup>35</sup>

We discuss the effects of these postsyntactic operations on head chains in turn.

The reference to [+P] in (39) has to do with the fact that lower copies of movement (traces) do not count as interveners, as evidenced, for instance, by predicate-internal traces of subjects, which do not trigger *do*-support (e.g. *Sue eats fish*). We formalize this as follows. First, we assume that all syntactic terminals and their projections are generated with the feature [+P]. Second, we adopt the copy theory of movement (Chomsky 1993, Nunes 1995), and assume as part of the definition of Move (Internal Merge) that [+P] is changed to [-P] in the lower copy and all nodes it dominates down to its syntactic terminals. The feature [-P] is relevant at PF, and renders its host invisible to spellout rules, including Vocabulary Insertion.<sup>36</sup> Given the restriction to elements specified as [+P], (39) excludes lower copies from the set of possible interveners.<sup>37</sup> On the other hand, in head chains such as those in (38) the intervening specifier (Neg or the subject) is [+P] and triggers *Split-by-intervention*:<sup>38</sup>

<sup>33</sup>See subsection 4.3 and 5 for additional sources of chain splitting in English and other languages.

<sup>34</sup>Intervention here is to be understood in the standard structural sense: *y* intervenes between *x* and *z* iff *x* asymmetrically c-commands *y* and *z*, and *y* asymmetrically c-commands *z*.

<sup>35</sup>This formulation presupposes that it is possible to identify the syntactic terminal a given morphological terminal is generated in. In the formalization of minimalist syntax proposed in Collins and Stabler 2016, this can be implemented by pairing the M-value of each lexical item token in a Lexical Array with the same index as that lexical item token.

<sup>36</sup>For a very similar proposal regarding the relation between movement and (non)pronunciation of copies, see Saab 2008, 2017, in which the feature we call [-P] is labeled [I]. For a similar analysis, but in a framework without late insertion, see Collins and Sabel 2015.

<sup>37</sup>Crucially, this does not exclude all covert elements as interveners. These are defined as elements marked as [+P], which may include morphemes that happen to be expounded as null, such as the one assumed here in the specifier of ΣP in verum focus sentences without an overt polarity particle (e.g. the version of (36b) without *so*). See subsection 4.3 and section 5 for further discussion of [±P] and its interaction with GenHM.

<sup>38</sup>No *do*-support applies in subject wh-questions (e.g. *Who eats fish?*). This is due to the restriction on interveners

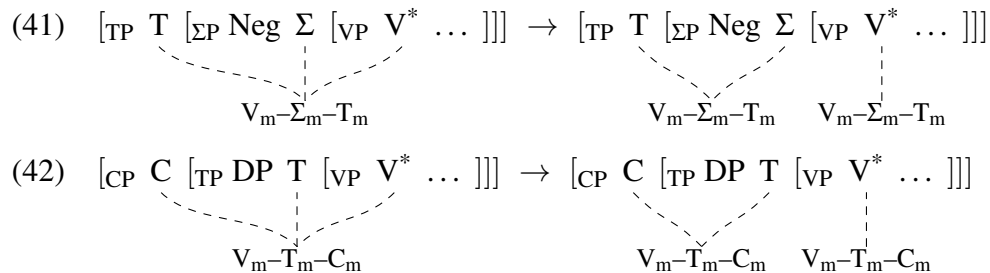

As represented in these examples, splitting a head chain consists in separating it into two chains, each of which contains a type-identical copy of the M-value in the original head chain. Furthermore, the split is stipulated to occur at V\* in (39), and does not necessarily correlate with the position of the intervener, as illustrated above. Empirical justification for this aspect of Split-by-intervention is provided below.<sup>39</sup>

Chain Splitting results in a periphrastic construction with two verbal words with the same M-value. As depicted in (43, 44), the higher word surfaces in T in negation contexts (and under verum focus) and in C under subject-auxiliary inversion, that is, in the highest position of the head chain. In both cases, the lower word surfaces in V\*, the only position in the head chain. The other postsyntactic operation proposed above, Orphan Assignment (40), ensures that certain parts of this periphrastic construction have a defective pronunciation. Specifically, because of chain splitting, some morphological terminals in the M-value of the split chains are no longer associated with the syntactic terminals they are base-generated in, and Orphan Assignment adds the feature [O] to those morphological terminals, which can thus be referred to as *orphans*. The following represents the effects of both Orphan Assignment and Head Chain Pronunciation:

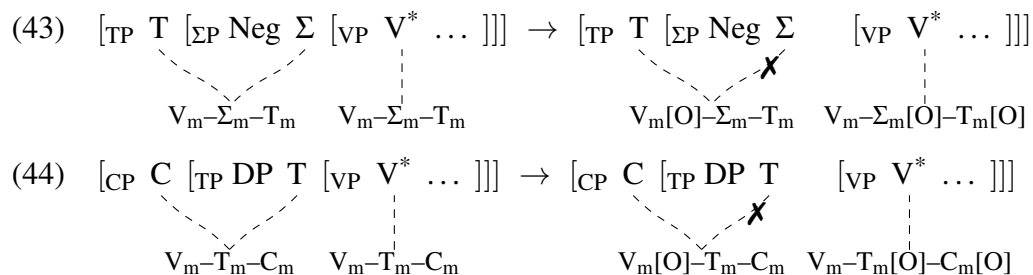

In particular, the orphans in these chains are (i)  $V_m$  in the higher chain (since it does not contain V) and (ii)  $T_m$  and  $\Sigma_m/C_m$  in the lower chain (since it does not contain T or  $\Sigma/C$ ). The feature [O] in orphan morphological terminals has an effect on their realization. Specifically, [O] overrides whatever other features would normally determine the exponence of  $V_m$ , which is invariably realized as *do* in the higher head chain. In the lower head chain, we propose that [O] triggers obliteration

in (39) to those specified as [+P]. Adapting the accounts in Chomsky 1957:69–72 and Bobaljik 1995:68–70 to our framework, we assume that the subject wh-phrase moves to the specifier of CP, and that C does form a head chain with V-T in this case, just as in all matrix wh-questions. What is special about subject wh-questions is that the intervening element in the specifier of TP is a lower copy of the moved wh-subject; as such, it is specified as [-P] and does not trigger chain splitting.

<sup>39</sup>A possible rationale for this stipulation is that strong heads such as V\* are constrained to be in head chains that meet stronger locality conditions than usual, and that this triggers a minimal repair that splits the strong head from a chain that does not meet these conditions.



in the sense of Arregi and Nevins 2007, 2012, that is, deletion of  $T_m$ .<sup>40</sup> As we show for Monnese in the next subsection and for several other languages in section 5, there is substantial variation in the ways in which [O] affects the exponence of orphans.

The structure in (44) of sentences with *do*-support under subject-auxiliary inversion shows why Split-by-intervention must, by definition, split the chain at  $V^*$  and not at a higher position. If the lower chain resulting from the split also contained T,  $T_m$  would be orphan and thus have defective pronunciation in the higher chain instead of the lower one, contrary to fact (cf. grammatical (36c) and \**Where do Sue eats fish?*)

This analysis of *do*-support differs in one fundamental way from the traditional view, in which *do*-support correlates with the lack of head V-to-T movement (Chomsky 1957, Lasnik 1981, Halle and Marantz 1993, Bobaljik 1995). We propose that *do*-support co-occurs with *successful* GenHM between V and T, creating a [ $V_m$ - $T_m$ ] complex head. The appearance of *do* is due to subsequent chain splitting, which renders  $V_m$  an orphan. As discussed in the next subsection, this correctly predicts that *do*-support is possible in a language which, outside of *do*-support contexts, exhibits V-to-T movement.

We would like to end our analysis of the English *do*-support paradigm with an account of contracted negation in English, which serves two purposes. First, it completes our analysis of English *do*-support, and more generally, of the morphosyntax of verbal inflection in this language. Second, it shows that, even though GenHM unifies Head Movement with what in other accounts is postsyntactic Lowering, it does not subsume all types of postsyntactic displacement of heads previously proposed in the literature, as discussed in section 2. We furthermore discuss particular ways in which GenHM can interact with these operations in the formation of complex heads.

As is well-known, contracted negation (*n't*) triggers *do*-support, just like its full counterpart, shown in (36a). In our analysis, this is ensured by the assumption that both *not* and *n't* are in specifier position, thereby triggering Split-by-intervention. On the other hand, unlike its full counterpart, contracted *n't* forms part of the morphological word with the immediately preceding finite verb (including *do*). This seems to contradict our claim that *n't* is a specifier, since, by definition, GenHM can only relate items that are in a head-to-head-of-complement relation. In resolving this apparent paradox, we maintain the assumption that *n't* is a specifier, as adopting an analysis in which *n't* is a head is not a viable option for another reason, pointed out by (Nevins 2010:22–24) (an early version of Nevins 2011). From its base-generated position between T and V, the predicted order if *n't* where the realization of a head would be is *n't*-T, by the Mirror Principle, but that's not what we observe: *n't* is always peripheral to the entire verbal word, as is clear in forms of *do* and auxiliaries with suffixal realization of finite inflection, such as *doe-s-n't* (\**do(e)-n't-s*) and *ha-d-n't* (\**ha(ve)-n't-ed*).<sup>41</sup>

In the spirit of Nevins 2010, our conclusion from this particular constellation of properties is that contracted negation does form part of a complex head with V/Aux and T, but that this is not due to GenHM (or any other syntactic operation). Rather, it is the result of *postsyntactic merger* (Marantz 1988, Embick and Noyer 2001), and more specifically, merger that combines a head

<sup>40</sup>The presence of [O] in  $\Sigma_m$  and  $C_m$  in the lower chains should also have an effect on their pronunciation. However, these morphological terminals have null realization, whether orphan or not.

<sup>41</sup>See Halle and Marantz 1993:124–129 for an explicit analysis of these auxiliaries (and other irregular English verbs) as containing overt suffixal inflection. For an opposing account in which contracted negation does form part of the verbal word by syntactic head displacement, see Merchant 2015:296–300, where, accordingly, it is assumed that irregular auxiliary forms (including those with contracted negation) are fusional and have no suffixal material.

with its specifier (Matushansky 2006, Harizanov 2014, Martinović, to appear). Like GenHM, the merger operation alters the M-values of the syntactic terminals related by the operation:

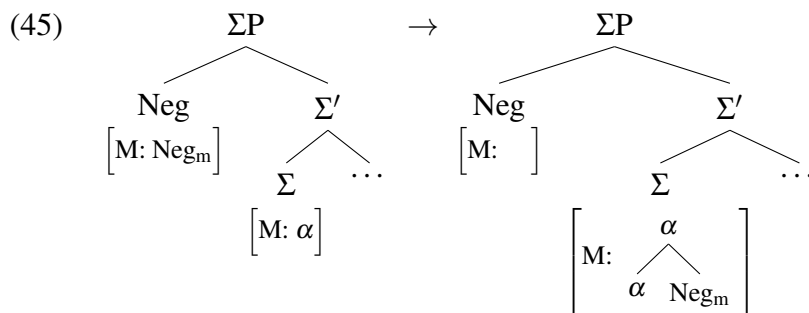

We assume that this *Negative Merger* operation is optional; the exponent of  $\text{Neg}_m$  is *n't* if it applies, and *not* otherwise. Like GenHM, the output is a new M-value formed from the M-values in the input; unlike GenHM, this new M-value is not shared by the input nodes, but only present in the head node ( $\Sigma$ ), which in effect implements merger as a downward displacement operation, as is universally assumed in the literature cited above.<sup>42</sup>

Negative Merger accounts for the puzzling set of properties of contracted negation discussed above. When it applies in the postsyntax, the M-value of  $\Sigma$  ( $\alpha$  in (45)) contains more than just  $\Sigma_m$ , as this syntactic terminal is part of a GenHM-generated head chain that includes other syntactic terminals. Specifically, in an example with auxiliary *be* such as (37a), the head chain contains Aux,  $\Sigma$ , and T. Negative Merger applies to  $\Sigma$  and Neg modifying the M-value of the former, which is shared by the entire head chain.<sup>43</sup>

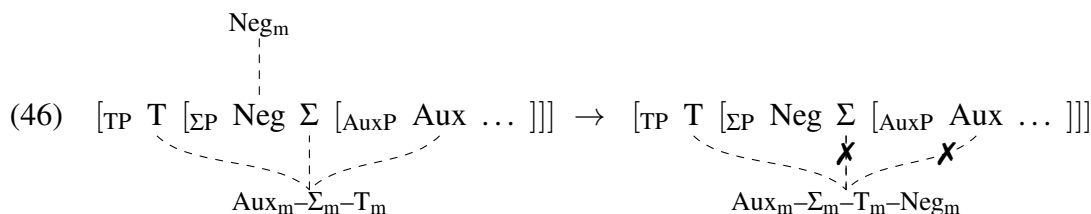

Since Negative Merger is postsyntactic,  $\text{Neg}_m$  is added to the M-value of the head chain generated in the syntax in an outer position, that is, peripheral to the other morphological terminals in the complex head, including  $T_m$ . Thus, the apparent violation of the Mirror Principle follows in a principled way from the fact that postsyntactic operations apply after syntactic operations.<sup>44</sup>

In cases of *do*-support (e.g. (36a)), Negative Merger interacts with Split-by-intervention and Orphan Assignment. In the syntax, GenHM generates a head chain with T,  $\Sigma$ , and  $V^*$ :

<sup>42</sup>This particular assumption is not crucial, and merger is easily implementable in terms of M-value-sharing. However, we know of no argument that merger is bidirectional in the sense that we argue GenHM to be here.

<sup>43</sup>The M-value of Neg in (46) is represented above it in order to avoid crossing the lines linked to the M-value of the head chain.

<sup>44</sup>This particular aspect of the analysis is heavily inspired by Harizanov and Gribanova's (2018) analysis of the interaction of syntactic and postsyntactic operations affecting heads.

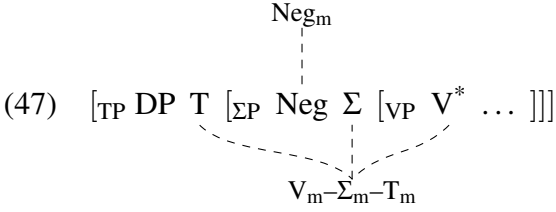

In the postsyntax, the head chain splits at V\*, triggering Orphan Assignment:

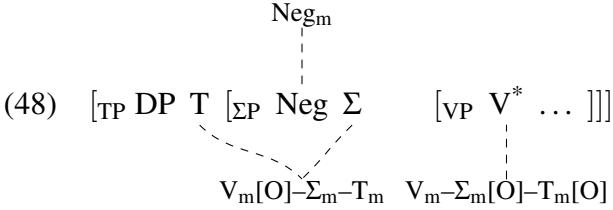

Next, Negative Merger attaches Neg<sub>m</sub> to the M-value of the higher chain:

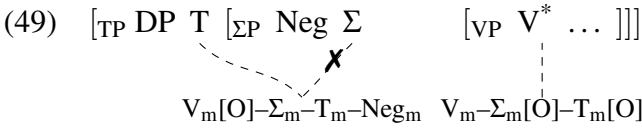

Finally, Head Chain Pronunciation determines that the M-value of the higher chain surfaces in T (as *doesn't*), and that of the lower chain in V\* (as *eat*).<sup>45</sup>

We conclude this subsection with a brief summary of the syntactic and postsyntactic operations, and their order of application. The two syntactic operations relevant in our discussion are GenHM and Move (which includes assignment of [-P] to lower copies). These are not extrinsically ordered with respect to each other (or any other syntactic rule), and their order in particular instances is determined by bottom-up cyclic application of rules in the syntax. The postsyntactic rules assumed so far are Linearization (including Head Chain Pronunciation (5)), Split-by-intervention (39), Orphan Assignment (40), Negative Merger (45), and Vocabulary Insertion, which apply in the following order (where ' $\alpha \prec \beta$ ' is to be understood as ' $\alpha$  precedes  $\beta$ ')

(50) *Order of postsyntactic operations*

Split-by-intervention  $\prec$  Orphan Assignment  $\prec$  Negative Merger  $\prec$  Linearization  $\prec$  Vocabulary Insertion

That Linearization and Vocabulary Insertion apply in this order at a relatively late postsyntactic stage is a standard assumption in Distributed Morphology (i.a. Embick and Noyer 2001, Embick 2010, Arregi and Nevins 2012). In the specific context of our analysis, these two operations must follow the other three, as the latter have clearly detectable effects on the linear order and phonetic form of morphological terminals. In addition, as part of Linearization, Head Chain Pronunciation follows Orphan Assignment, and thus does not create orphans, despite the fact that it delinks some syntactic terminals from their associated M-values. The relative order of the first three operations in (50) is justified as follows. First, Orphan Assignment must crucially follow Split-by-intervention, for the latter to have any effect on the exponence of split chains. Second, the main effect of ordering

<sup>45</sup>The analysis also accounts for sentences in which *n't* is attached to finite verbs displaced to C (e.g. *Isn't Sue eating fish?*, *Doesn't Sue eat fish?*). These simply involve a further step of GenHM between T and C.

Negative Merger after Split-by-intervention and Orphan Assignment is that  $\text{Neg}_m$  does not become an orphan as a result of merger with the M-value of the head chain containing  $\Sigma$ , which allowed us to simplify our derivations above. However, ordering Negative Merger earlier in the postsyntactic derivation does not actually result in any predictions that can be tested in English.<sup>46</sup>

## 4.2 Directionality of displacement and *do*-support: No correlation

In the present analysis, *do*-support is dependent on the presence of a strong V head that can trigger chain splitting. Since strong features typically give rise to downward head displacement, the account captures the correlation between *do*-support and downward head displacement observed in English. However, this correlation is weak, and we predict that it does not hold in certain circumstances. The prediction is borne out in two different directions. First, downward displacement does not always alternate with *do*-support in Mainland Scandinavian. Second, *do*-support alternates with *upward* displacement of lexical verbs to T in Monnese. Taken together, these crosslinguistic data provide an additional argument for the unification of upward and downward displacement under GenHM.

The first prediction stems from the possibility that a language may simply not have Split-by-intervention. This is the case of Mainland Scandinavian. As we saw in subsection 3.2, V is strong in these languages, which accounts for the low position of finite verbs in non-V2 environments. However, unlike English, neither negation nor subject-verb inversion trigger *do*-support:

- (51) Jeg tror [CP at Johan ikke købte bogen ]  
 I believe [CP that Johan not bought the.book ]  
 ‘I believe that Johan didn’t buy the book.’ Danish (Vikner 1995:144)
- (52) Om morgenen drikker Peter ofte kaffe.  
 in the.morning drinks Peter often coffee  
 ‘Peter often drinks coffee in the morning.’ Danish (Vikner 1995:47)

In (51), the finite verb surfaces to the right of negation, and in (52), to the left of the subject. Neither structure involves *do*-support, which follows from the assumption that these languages do not have Split-by-intervention.<sup>47</sup>

A second way in which there may not be a correlation between *do*-support and downward head displacement has to do with the relation between strong heads and the directionality of head displacement. Although a strong V typically results in downward displacement, this need not be so: if the strong V is part of a chain with a higher strong head, the complex head will surface in the higher strong position, as is the case in V2 sentences in MSc (subsection 3.2). In this type of head chain, if the language has Split-by-intervention, the chain will split in the presence of

<sup>46</sup>If  $\text{Neg}_m$  were merged with the M-value in  $\Sigma$  before Orphan Assignment applied, it would become an orphan, as it would no longer be in a head chain containing  $\text{Neg}$ . This is compatible with the facts: the only other change that would be required in the analysis would be that *n’t* is the realization of  $\text{Neg}_m[\text{O}]$ , not of  $\text{Neg}_m$ . Under the order assumed in the text,  $\text{Neg}_m$  is never an orphan, and *n’t* must be assumed to be the realization of  $\text{Neg}_m$  (without the [O] feature).

<sup>47</sup>Bobaljik (1995:78–88) proposes that downward displacement in Mainland Scandinavian is subject to the same adjacency conditions as in English, and uses this to derive Holmberg’s Generalization. The analysis is predicated on the existence of a strict correlation between the directionality of head displacement and the availability of object shift. As shown in the literature reviewed in appendix A, this correlation does not hold.

an intervening specifier. The predicted pattern is thus one in which *upward* head displacement alternates with *do*-support. This is precisely the pattern found in Monnese, as argued in [Benincá and Poletto 2004](#).<sup>48</sup>

First, both lexical verbs (53) and auxiliaries (54) undergo upward displacement to T in finite contexts, as shown by their placement before adverbials including negation.

- (53) a. l **tfàkola**                    semper                    b. l **tfàkola**                    mià  
           he speak.PRS.IND.3SG always                    he speak.PRS.IND.3SG not  
           ‘He always speaks.’                                    ‘He doesn’t speak.’

Monnese ([Benincá and Poletto 2004:59–60](#))

- (54) l **à**                                    semper tfakolà  
           he have.PRS.IND.3SG always spoken  
           ‘He has always spoken.’                                    Monnese ([Benincá and Poletto 2004:59](#))

Second, auxiliaries surface in C (to the left of subject clitics) in subject-auxiliary inversion constructions such as matrix (nonsubject) questions:

- (55) **à**                                    -l majà?  
           have.PRS.IND.3SG -he eaten  
           ‘Has he eaten?’                                    Monnese ([Benincá and Poletto 2004:52](#))

Finally, in subject-auxiliary inversion contexts, finite lexical verbs do not surface in C and instead trigger *do*-support:

- (56) a. \***maja**                            -l ?                    b. **fe**                                    -l majá?  
           eat.PRS.IND.3SG -he                    do.PRS.IND.3SG -he eat.INF  
           ‘Does he eat?’                                    ‘Does he eat?’

Monnese ([Benincá and Poletto 2004:52](#))

That is, instead of inverting with the subject clitic, the pre-subject position is filled by dummy *fá* ‘do’ with finite inflection, and the lexical verb surfaces in infinitival form after the subject clitic. As shown in [Bjorkman 2011](#), the infinitival lexical verb is in a low position below T and follows adverbials (contrasting with the high position of finite lexical verbs, shown in (53)). We take this low position to be V:

- (57) fe                                    -t    mià **majal** ’l pom?  
           do.PRS.IND.2SG -you not eat.INF the apple  
           ‘Do you not eat the apple?’                                    Monnese ([Bjorkman 2011:190–191](#))

The GenHM analysis of this pattern is as follows. Both finite T and lexical verbs in Monnese are strong, and auxiliary verbs are weak. In sentences without displacement to C, finite verbs surface in T, whether they are auxiliaries or lexical verbs. In sentences in which C triggers GenHM, C is strong. If the verb is an auxiliary, the M-value of the resulting head chain surfaces in the inverted position in C\*:

<sup>48</sup>Monnese is the variety of Lombard (Northern Italian Romance) spoken in the village of Monno.

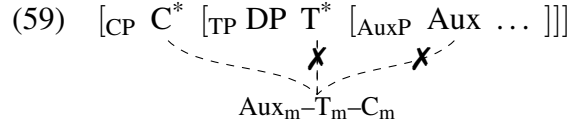
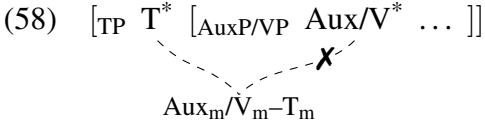

However, lexical verbs in the inversion context trigger Split-by-intervention and concomitant Orphan Assignment, as they are strong and the subject clitic disrupts structural adjacency in the head chain:<sup>49</sup>

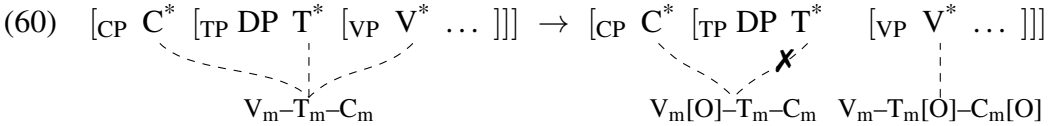

As in English,  $V_m$  is an orphan in the higher chain, and so is  $T_m$  in the lower chain. Consequently,  $V_m$  is exponed as *fá* in finite form in the higher pre-subject position in C. Orphan  $T_m$  in the lower chain also surfaces in defective form, which in the case of Monnese is infinitival inflection. We assume that this is due to impoverishment of tense (and agreement) features in  $T_m$ , which therefore surfaces in default infinitival form. This contrasts minimally with English, in which [O] triggers obliteration instead of impoverishment.

Note, finally, that the low position of the infinitival verb in (57) shows that the split is at  $V^*$ , and not at the precise position of the intervener (the subject clitic). This corroborates our findings about English (see previous subsection).

To conclude, the correlation between the directionality of head displacement and *do*-support is spurious and does not hold crosslinguistically. The specific case of Monnese shows that *do*-support can alternate with upward instead of downward displacement. This is a strong argument for the unification of upward and downward head displacement proposed here. The pattern found in this dialect is particularly illuminating to our theory, as it shows that strength can be diagnosed independently of word order: in Monnese, Aux is weak and (lexical) V is strong, as diagnosed by *do*-support, but both verb types surface in the same position in finite contexts. This aspect of the theory is further confirmed by the interaction of GenHM and VP ellipsis in Mainland Scandinavian, to which we now turn.

### 4.3 VP ellipsis and *do*-support

In this subsection, we focus on a different known correlation between *do*-support and the directionality of head displacement. The correlation is manifested in how VP ellipsis (VPE) affects pronunciation of the verb. In languages with downward head displacement, like English, VPE triggers *do*-support (61). Upward head displacement, on the other hand, is correlated with full pronunciation of the verb outside the ellipsis site, illustrated in (62) with Polish. This latter phenomenon is known as verb-stranding VPE (VVPE), documented e.g. in McCloskey 1991, Doron 1999, Ngonyani 1996, Goldberg 2005, Gribanova 2013, and for Polish specifically in Ruda 2014.<sup>50</sup>

<sup>49</sup>Unlike subject-auxiliary inversion, negation does not trigger *do*-support in Monnese (Benincá and Poletto 2004:70–71). As shown above, finite verbs surface to the left of negation (53b). We assume that this particle is a VP adverbial in Monnese, and thus does not disrupt structural adjacency in head chains.

<sup>50</sup>Although verb movement in Polish is difficult to diagnose, arguments for V-to-T movement can be found e.g. in Borsley and Rivero 1994 and Migdalski 2006.



(61) *Do-support VPE*

I wanted to give him a book and I **did**.

(62) *Verb-stranding VPE*

Chciałam mu dać książkę i (\*ją) **dałam**.  
 wanted.1sg give.INF him book and (\*it) gave.1sg

‘I wanted to give him a book and I did’.

Polish

In the present account, the two types of ellipsis involve the same syntactic operation – GenHM relating V with some higher head X. The contrast between them is due to different spellout of the verb in X after VP ellipsis. If V is strong (English), its pronunciation in X is defective, namely as *do* (63a). In a language with a weak V, like Polish, the verb is pronounced fully (63b).

(63) a. *Do-support VPE*

$$\left[ \underset{\text{GenHM}}{\text{XP}} \text{X} \left[ \text{VP} \text{V}^* \text{DP} \right] \right]$$

b. *Verb-stranding VPE*

$$\left[ \underset{\text{GenHM}}{\text{XP}} \text{X} \left[ \text{VP} \text{V} \text{DP} \right] \right]$$

We argue that, as in negation/verum focus and inversion contexts (discussed in the previous subsections), *do*-support in ellipsis is the result of chain splitting in a strong-V chain. More specifically, we propose that ellipsis, like intervention, is a trigger of chain splitting. We illustrate this account with derivations of *do*-support VPE in English and of VVPE in Polish. We then move on to an interesting interaction of VPE and *do*-support in Mainland Scandinavian, which supports the view that *do*-support is a direct consequence of strength (specifically of a strong V), rather than a correlate of downward head displacement.

Let us start with VVPE, which involves upward displacement of V to some head outside of the ellipsis site, for example T. We assume that ellipsis is not strictly speaking structure deletion but rather non-pronunciation (i.a. Wilder 1997, Bartos 2000, Merchant 2001, Kornfeld and Saab 2004, Murguía 2004), and, like the non-pronunciation of lower copies of movement, we formalize it as assignment of [-P].<sup>51</sup> Specifically, ellipsis is syntactic assignment of [-P] to the elided constituent and all nodes it dominates down to its syntactic terminals, whose M-values are therefore not subject to Vocabulary Insertion.<sup>52</sup> Given these assumptions, VVPE is derived in a configuration in which V is weak as follows:

<sup>51</sup>That is, we assume that ellipsis involves the same process as nonpronunciation of copies in phrasal movement chains, namely assignment of [-P] to the affected constituent (Chomsky 1993:34–35, Chomsky 1995:252–253, Saab 2008:331–484).

<sup>52</sup>As mentioned in footnote 36, our feature [-P] is similar to Saab’s (2008, 2017) [I], though we remain agnostic as to its relation to identity conditions on ellipsis. Since [-P] is assigned to syntactic nodes and not to the nodes in M-values, we also derive Saab’s *Sub-Word Deletion Corollary*, according to which [-P]/[I] is inert below the M-word level.

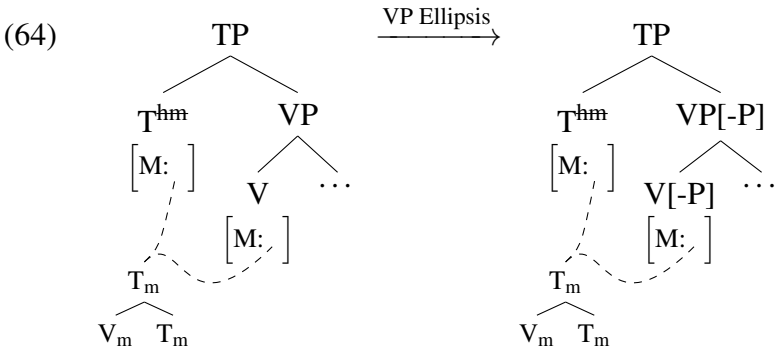

Because of ellipsis, no material in VP is pronounced, but in any case,  $V_m$  is spelled out as part of the M-value of T – the highest head. Thus, VP ellipsis does not affect the spellout of the verb in this case. In contrast, ellipsis of a strong V does affect its pronunciation – it makes it defective. We capture this by an additional rule of chain splitting (65b):

(65) *Chain Splitting*

a. *Split-by-intervention*

In a head chain terminating in  $V^*$  such that a specifier marked [+P] intervenes between the top of the chain and  $V^*$ , split the chain at  $V^*$ .

b. *Split-by-deletion*

In a head chain terminating in a  $V^*$  marked [-P], split the chain at  $V^*$ .

As shown above, we take both Split-by-intervention and Split-by-deletion to be subcases of a more general process of Chain Splitting. We accordingly revise the order of operations proposed in (50), by replacing Split-by-intervention with Chain Splitting.

Since English is a language with strong V, Split-by-deletion applies in VPE. As a result,  $V_m$  in the higher chain is not associated with  $V^*$  and is thus assigned an orphan feature:

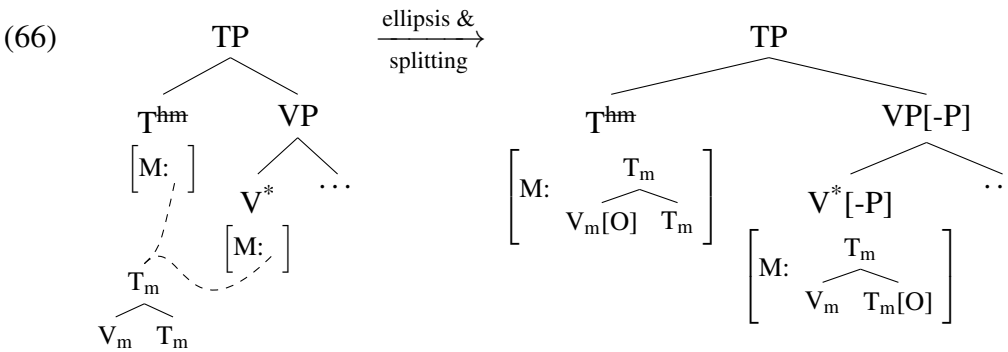

The higher chain thus surfaces as a finite form of *do*.  $T_m$  in the lower chain is also an orphan, but this chain is not subject to Vocabulary Insertion because of ellipsis.

As in cases of Split-by-intervention, the appearance of *do* in ellipsis contexts is not directly related to downward head displacement in the present account. Rather, it arises due to the presence of a strong V head, which triggers Split-by-deletion and effectively a defective pronunciation of  $V_m$  in T. We thus predict that downward displacement and ellipsis-triggered *do*-support tend to cooccur, as they are both triggered by a strong V. However, we also predict that exceptions to this tendency could be found. Recall from the previous subsection that V in Monnese is strong, and

yet the language exhibits V-to-T upward displacement. This is because both T and V are strong in this language. We thus predict that, if Monnese had VP ellipsis, it should be *do*-support VPE, not VVPE, despite the fact that the language has V-to-T raising. However, as reported in Benincá and Poletto 2004:71-72, there is no evidence for VPE in Monnese.<sup>53</sup>

It turns out, however, that a similar argument can be made on the basis of Mainland Scandinavian languages, for which we do have documented instances of VPE (Sailor 2009, 2018, Houser, Mikkelsen, and Toosarvandani 2011, Platzack 2012, Thoms 2012, Bentzen, Merchant, and Svenonius 2013). Recall that V2 clauses in MSc have a strong C. Given that a lexical verb raises to C in V2 clauses, one might expect these languages to display V-stranding VPE in these contexts (an observation due to Sailor (2009, 2018)). This prediction follows only under the assumption that upward displacement of a verb to head X directly correlates with stranding of the verb in X under VPE. This, however, is not the case. As shown in (67), a lexical finite verb cannot surface in second position in a V2 sentence with VPE (Sailor 2009, 2018, Platzack 2012, Thoms 2012), and the V2 requirement is satisfied by a dummy auxiliary translatable as ‘do’ (*gøre* in Danish):<sup>54</sup>

- (67) Mona og Jasper vaskede bilen, eller rettere Mona {\*vaskede / gjorde}.  
 Mona and Jasper washed the.car or rather Mona washed / did  
 ‘Mona and Jasper washed the car, or rather Mona did.’

Danish (Sailor 2018:(7a, 8a))

Our account, on the other hand, correctly predicts *do*-support in C, despite the usual V-to-C displacement in this environment. This is due to the fact that V in MSc is strong, triggering Split-by-deletion under ellipsis:

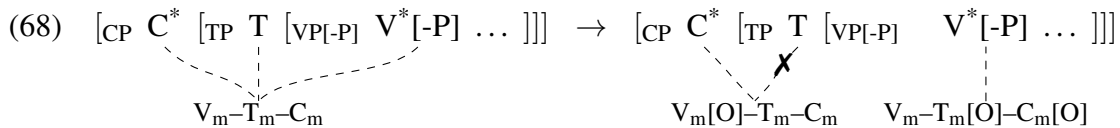
- (68)  $[CP\ C^* [TP\ T [VP[-P]\ V^*[-P] \dots ]]] \rightarrow [CP\ C^* [TP\ T [VP[-P]\ V^*[-P] \dots ]]]$   

The M-value in the higher chain thus contains an orphan  $V_m$  and is pronounced in C, the highest strong position. In Danish,  $V_m[O]$  is realized as the verb *gøre*.

Previous analyses of the MSc puzzle assume that the correlation between directionality of displacement and *do*-support is absolute and that apparent exceptions, such as the Danish case above, must involve a confounding factor. For instance, Sailor (2009, 2018) takes examples such as (67) to be evidence that VPE prevents movement of V to C, as only the absence of such movement can trigger *do*-support. His account relies on two crucial assumptions. First, following Aelbrecht 2010, ellipsis applies at the stage of the syntactic derivation that the licensing head (here T) is merged with the constituent containing the target of ellipsis (here VP), and makes elided material inaccessible to subsequent operations, including movement. The second assumption is that in MSc V2 clauses, C attracts V (not T) directly when the former is merged (with a possible countercyclic step in T enforced by locality). The derivation of (67) thus proceeds as follows:

<sup>53</sup>We also predict that Monnese has *do*-support under VP fronting (see below). Benincá and Poletto (2004) do not report whether Monnese has this construction.

<sup>54</sup>Another locus of VPE-triggered *do*-support in MSc is in a low position (below negation and low adverbs). It is found in non-V2 clauses and optionally under auxiliaries. Following previous work (Bjorkman 2011, Thoms 2012), we assume that the appearance of a low *do* involves a low head that survives VPE and is targeted by GenHM and *do*-support.

(69) a. [<sub>TP</sub> T [<sub>VP</sub> V DP]]

b. [<sub>CP</sub> C [<sub>TP</sub> T [<sub>VP</sub> V DP]]]

T is merged and triggers ellipsis of VP (69a). At this stage, V does not move out of VP, since, by hypothesis, V2 movement is triggered when C is merged (and other than in V2, V stays in situ in MSc). When C is merged (69b), this head attracts a V, but the lexical verb in VP is not accessible to syntactic operations at this point. Importantly, the head triggering VPE (T) is merged before the head triggering movement of V (C), which results in ellipsis bleeding movement.<sup>55</sup>

We would like to raise two issues with this account, both related to the assumption that C attracts V directly. First, in the absence of independent V-to-T displacement, this account requires positing a countercyclic V-to-T step, occurring only after a higher movement trigger has been merged. As discussed in subsection 3.2, the GenHM framework allows for a fully cyclic derivation of MSc V2 clauses. Secondly, if C attracts V, not T, and VPE makes the verb inaccessible, we expect no movement to C at all in VPE contexts. Nonetheless, the support verb surfacing in C is inflected for tense and agreement, suggesting that T-to-C movement has taken place. This fact follows naturally from the present account, in which the syntactic derivation of *do*-support is the standard GenHM derivation. What is pronounced in C is the entire complex M-value, which includes T<sub>m</sub> and an orphan V<sub>m</sub>.<sup>56</sup>

Our analysis of VP ellipsis extends straightforwardly to VP fronting, often referred to as predicate clefting (i.a. Koopman 1984, Davis and Prince 1986, Harbour 1999, Abels 2001, Cable 2004, Landau 2006, Vicente 2007, Hein 2018). The two phenomena show a parallel behavior in how they affect pronunciation of the verb. Like VP ellipsis, VP fronting can result in full pronunciation of the verb in the main clause (70) or a deficient pronunciation as *do* (71).<sup>57</sup>

(70) *Verb-stranding VP fronting*

[<sub>VP</sub> Oglądać mecz] [<sub>TP</sub> oglądałam t<sub>VP</sub>]  
watch.INF game watched.1SG

‘Watch the game, I did.’

Polish

(71) *Do-support VP fronting*

[<sub>VP</sub> watch the game] [<sub>TP</sub> I did t<sub>VP</sub>]

Recall that nonpronunciation of lower copies in phrasal movement involves assignment of [-P] (subsection 4.1). Thus, the matrix TP in VP-fronting constructions undergoes exactly the same operations as in VP ellipsis – in the examples above, GenHM relating V and T and [-P] assignment to the VP (64, 66). Given this parallel, we correctly predict that languages with *do*-support VPE should exhibit *do*-support VP Fronting (e.g. English), while languages with V-stranding VPE have

---

<sup>55</sup>Sailor derives VVPE under the assumption that the same head triggers VPE and movement of V out of VP. Since operations triggered by the same head occur in parallel, no bleeding ensues.

<sup>56</sup>A possible solution to this problem could be insertion of *do* in T, not in C. Assuming that such insertion contributes the verbal feature that C attracts, T could then move to C. Sailor does not provide the necessary details about the *do*-support mechanism to determine if this solution is possible in his analysis. One important question would be how an apparently postsyntactic process (*do*-insertion) can feed syntactic movement.

<sup>57</sup>There exist verb-doubling constructions which have been described as being distinct from predicate clefts/VP fronting; see e.g. Martins 2007 for Portuguese, and Saab 2008, 2017 for Argentinean Spanish.

V-stranding VP fronting (e.g. Polish, Russian). Recall that *do*-support generally correlates with a strong V.<sup>58</sup>

(72)

	V*	V
VP ellipsis	<i>do</i> -support	V-stranding
VP fronting	<i>do</i> -support	V-stranding

VP-fronting is analyzed in more detail in the next section, where we focus on the spellout of the fronted VP (see also appendix B). At this point, we would like to point out another parallel that can be observed in the table above, namely the fact that *do* alternates with full pronunciation of the verb in two different constructions. This systematic alternation fits well in a theory which, like GenHM, makes a very close connection between *do* and a fully pronounced verb. Note that, at some level of description, (70) and (71) are identical: they involve VP fronting that strands a verb in the main clause. The difference lies in the form of the stranded verb. In our theory, the level at which (70) and (71) are uniform is narrow syntax; the contrast arises at Spellout (the same is true of the corresponding ellipsis cases).

We close the discussion of *do*-support with another typological prediction. In this and in the previous subsection, we proposed two chain-splitting processes that create orphan morphological terminals: Split-by-intervention and Split-by-deletion. In principle, the two can be active in a language independently of one another. Given the present analysis of *do*-support as a spellout of an orphan  $V_m$ , we predict that languages may differ in the distribution of *do*-support, depending on which orphan-creating processes are active in a language. The comparison of *do*-support contexts in English and MSc instantiates part of the predicted typology:

(73)

	English	MSc
Split-by-intervention	✓	✗
Split-by-deletion	✓	✓

Split-by-intervention is active in English, giving rise to *do*-support in structures with specifiers intervening between members of a lexical head chain. As this rule is inactive in MSc, no *do*-support occurs in these contexts. Split-by-deletion, on the other hand, is active in both English and MSc, deriving *do*-support in VP ellipsis and fronting in all these languages. Distinguishing two sources of orphan terminals predicts not simply variation in *do*-support contexts, but precisely this clustering of constructions in which *do*-support is found.

Variation in the availability of the two types of chain splitting predicts the existence of two other language types with strong V: (i) languages with Split-by-intervention but no Split-by-deletion (e.g. *do*-support with subject-auxiliary inversion but not with VP ellipsis), and (ii) languages without any type of chain splitting and thus no *do*-support at all. We do not know of any language that fits

<sup>58</sup>A different approach to crosslinguistic variation in *do*-support vs. V-stranding in VP fronting is offered by Hein (2018), who derives it by positing variation in the order of application of postsyntactic chain reduction and head movement. The analysis crucially relies on the hypothesis that *do*-support arises in the absence of head displacement. Like other approaches along these lines, it cannot account for the phenomenon in Monnese (subsection 4.2), or for inflection doubling in VP fronting (section 5).

either description. Monnese may instantiate the former, but, as noted above, it does not have VP ellipsis, and VP fronting has not been tested. We would like to tentatively link them to the scarcity of languages with downward displacement in verbal chains (at least among languages in which the directionality of verbal head displacement has been studied in detail). The latter fact follows from the hypothesis that strong lexical items are featurally marked with respect to weak ones, and thus predicted to be less common, with the potential consequence that a full typology of chain splitting would be hard to instantiate fully. The search for languages of this type might be further hindered by the (un)availability of the relevant constructions (e.g. VP ellipsis is absent in Monese, as in most Romance languages). Pending further research into languages with strong V, we cannot make any firm conclusions in this respect, but if it does turn out that these are genuine typological gaps, it might point towards an analysis in which Split-by-deletion is universal (yielding *do*-support under VP ellipsis and fronting in *all* languages with strong V), in contrast with Split-by-deletion, which we know is active only in some languages (English and Monnese, but not MSc).

We argued in this subsection against a direct correlation between directionality of displacement and the choice between *do*-support and V-stranding. There does appear to be a *tendency* for *do*-support to appear in languages with downward verb displacement. This tendency is expected under our theory as downward displacement and *do*-support both rely on the language having a strong V. Crucially, however, we also allow *upward* displacement (e.g. V to C in MSc; V to T in Monnese) to co-occur with *do*-support, rather than with V-stranding. One might wonder why patterns like MSc and Monnese *do*-support are not more common. If they were, the correlation between downward displacement and *do*-support would have perhaps never been posited. In our view, this has to do with the specific marked configuration that is required to allow *do*-support and upward displacement to cooccur in a language. In particular, it requires at least two strong heads: V and some higher head (T in Monnese, C in Msc). Given that strong lexical items are marked with respect to weak ones, we expect configurations with multiple strong heads to be crosslinguistically less common than those with one strong head.

## 5 A final argument from predicate clefting

In the GenHM framework, the unification of upward and downward displacement is implemented as linking multiple syntactic terminals to the same M-value. In this section, we present evidence from predicate clefts for this implementation. In particular, we show that it allows us to account for inflection doubling in Swedish, as well as root allomorphy in Yiddish. We then return to languages in which the clefted predicate is an infinitive or a bare form and show how this inflectional deficiency is captured by the system developed in previous sections. In a nutshell, we argue that the lack of finite inflection in the fronted verb is due to phrasal movement creating a defective chain in the fronted VP.

As discussed in the previous section, predicate clefting involves movement of a verb (VP or possibly a bare V)<sup>59</sup> to a sentence initial position. In V-stranding languages, the verb is pronounced

---

<sup>59</sup>In some languages it is clear that predicate clefting involves fronting of the entire VP as the fronted constituent may include the object (e.g. Polish, Russian, Swedish). However, some languages have been argued to allow bare V fronting (see e.g. Källgren and Prince 1989 for Yiddish, Lema and Rivero 1990 for Bulgarian, Landau 2006 for Hebrew, and Vicente 2007 for Spanish and Hungarian). We follow previous literature in unifying VP-fronting and bare V fronting as the same the type of operation, namely Move (copy-and-delete). See appendix B for a derivation of bare V fronting in our system.



twice, in the fronted position and inside of the main clause:

- (74) a. **Zaśpiewać**, może **zaśpiewam**.  
 sing.INF maybe sing.FUT.1SG

‘Sing, maybe I will.’

Polish

- b. **lirkod**, Gil lo **yirkod** ba-xayim.  
 dance.INF Gil not dance.FUT in-the-life

‘As for dancing, Gil will never dance.’

Hebrew (Landau 2006:32)

Typically, the fronted copy of the verb does not bear finite inflection and takes the infinitival form instead. The standard analysis of this pattern derives the inflection asymmetry between the two copies by remnant fronting of some constituent below T, e.g. a VP. The lower copy of the verb undergoes displacement to T, where it receives finite inflection. The fronted copy, however, is never in a relation with T and is therefore uninflected (75).

- (75) [CP [VP<sub>i</sub> V] C [TP V<sub>j</sub>+T [~~VP<sub>i</sub> V<sub>j</sub>~~]]]

This analysis is well suited for predicate clefts in English, in which the fronted verb is bare. It is also typically adopted for languages with infinitival morphology in the fronted VP.

Generalized Head Movement generates a different structure for predicate clefts. It relates T and V, creating a complex M-value [V<sub>m</sub>-T<sub>m</sub>] associated with both syntactic terminals. This operation takes place before the trigger of VP fronting, e.g. C, is merged. Assuming the copy theory of movement, VP fronting creates a type-identical copy of the VP, including the V’s M-value, which is then merged with CP (76). The consequence of this derivation is that the fronted remnant VP has its own head chain which contains the entire [V<sub>m</sub>-T<sub>m</sub>] complex. Note that, in the newly created chain, T<sub>m</sub> is an orphan, as it has no corresponding syntactic terminal T in this chain (we return to this issue shortly).

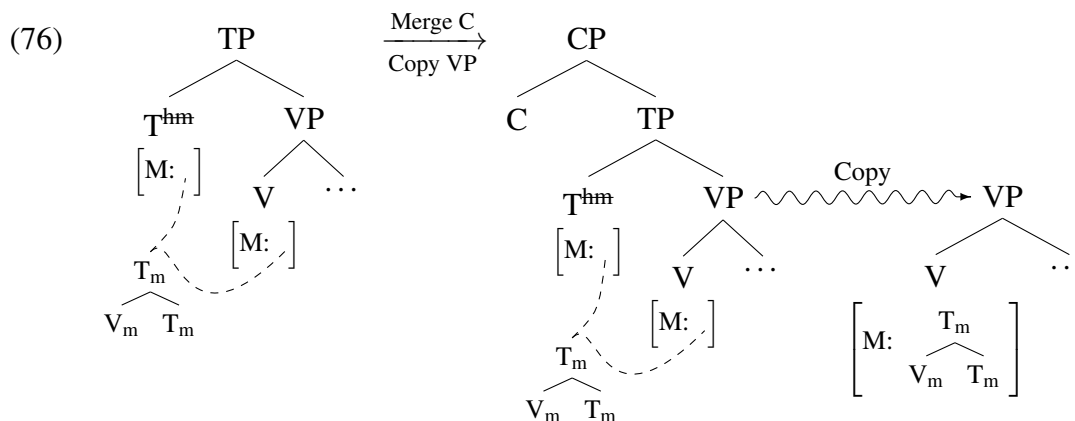

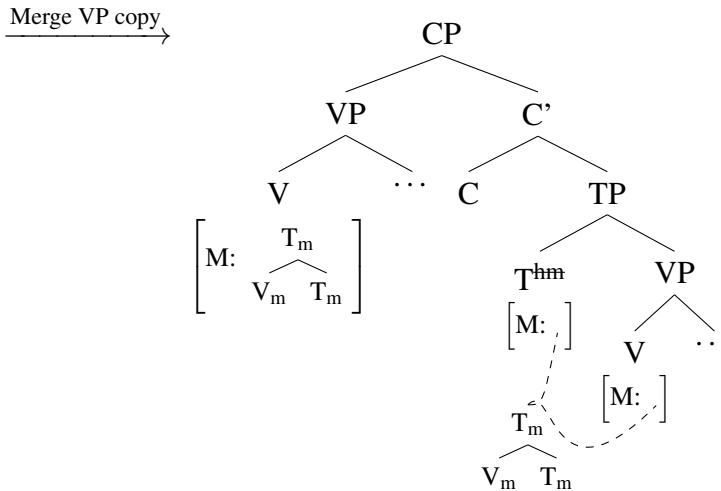

Since Vocabulary Insertion applies to morphological terminals, GenHM predicts that both copies of the verb should be inflected in predicate clefts. Interestingly, this prediction is borne out in some languages. In Swedish (and optionally in Norwegian and Danish; see Platzack 2012) predicate clefts bear full finite inflection. As we see in (77), the fronted verb cannot be bare and must instead appear in its past tense form. Importantly, finite inflection on the fronted verb co-occurs with identical inflection on the support verb *gjorde* stranded in the main clause.

- (77) och [<sub>VP</sub> {\***köra** / **körde**} bilen ] **gjorde** han *t<sub>VP</sub>*  
 and drive.INF / drive.PST the.car do.PST he  
 ‘... and drive the car he did.’

Swedish (Platzack 2012:281)

As (77) is a matrix clause, *do* appears in a V2 position, in C. Thus, the shared M-value created by GenHM and copied by VP fronting is [V<sub>m</sub>-T<sub>m</sub>-C<sub>m</sub>] (78). As a result of phrasal movement, the lower copy of the VP is assigned [-P].

- (78) [CP C\* [TP T [VP V\* ]]] → [VP V\* ] [C' C\* [TP T [VP[-P] V\*[-P] ]]]
- 

The clause-internal head chain contains a strong head with a [-P] feature, namely V\*[-P]. The presence of such a head triggers Split-by-deletion, and concomitant assignment of [O] to V<sub>m</sub> in the C\*-T head chain, giving rise to *do*-support in the main clause. On the other hand, the orphans in the chain in the higher VP copy are T<sub>m</sub> and C<sub>m</sub>, since this head chain does not contain their corresponding syntactic terminals T and C:

- (79) [VP V\* ... ] [C' C\* [TP T [VP[-P] V\*[-P] ... ]]]
- 

We propose that inflection doubling in Swedish arises because the orphan feature on T<sub>m</sub> in the higher VP copy has no effect on the pronunciation of this morphological terminal. That is, unlike V<sub>m</sub>[O] (which is pronounced as ‘do’), there is no special pronunciation of T<sub>m</sub>[O] in Swedish. C<sub>m</sub> in MSc has a null exponent and the [O] feature does not change that.

In Yiddish, the orphan feature does have an effect on the spellout of  $T_m$  – the inflection on the fronted verb is always the infinitival suffix *-(e)n* (80). Interestingly, however, the fronted verb is not the usual infinitive: the verb root has the same form as in finite forms, despite the infinitival suffix (Waletzky 1969, Davis and Prince 1986, Källgren and Prince 1989, Travis 2003, Kilbourn-Ceron et al. 2016). In (80a), for instance, the root allomorph in the *pseudo-infinitive* form of ‘know’ is *veys* – the same as in the first singular form. A true infinitive takes the root allomorph *vis*. What is important is that the root allomorph of a pseudo-infinitive is conditioned by the inflection (tense and agreement) of the matrix clause, i.e. it is always identical to the matrix clause occurrence of the verb (80b–80c).

- (80) a. **Veys-n,**                      veys                      ix.    (inf: *vis-n*)  
           know.PRS.1SG-INF know.PRS.1SG I  
           ‘I know.’    Yiddish (Travis 2003:244)
- b. **Iz-n,**                              iz                              es reb yikhezk1      gobiners shtub.                      (inf: *zay-n*)  
           be.PRS.3SG-INF be.PRS.3SG it Mr. Yikhezk1’s home  
           ‘It is Mr. Yikhezk1’s home.’    Yiddish (Travis 2003:244)
- c. **Bin-en,**                              bin                              ikh in amerike.    (inf: *zay-n*)  
           be.PRS.1SG-INF be.PRS.1SG I in Americal  
           ‘As for being, I am in America.’    Yiddish (Kilbourn-Ceron et al. 2016:150)

This puzzling morphology of Yiddish pseudo-infinitives is easily captured by GenHM, which predicts that the fronted copy of the verb contains an orphan  $T_m$ :

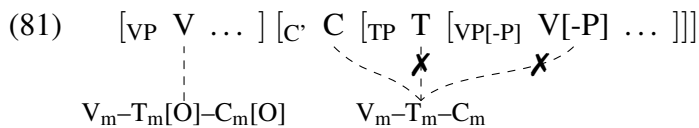

$T_m$  in the higher VP copy has defective pronunciation (due to [O]), but its presence is revealed by its tense and agreement features conditioning root allomorphy. The result is a hybrid of a finite root and an infinitival suffix. Note that Yiddish is a V-stranding language: it has weak V and thus no Split-by-deletion, causing full pronunciation of  $V_m$  in C.

The evidence for  $T_m$  in the fronted VP thus supports our implementation of GenHM as feature sharing, which is responsible for associating  $T_m$  with the syntactic terminal V. It additionally supports the view of GenHM as a syntactic, rather than a postsyntactic operation. In order for inflection doubling to arise, the higher VP copy must contain a V whose M-value includes  $T_m$ , as in (76). That is, GenHM between V and T must occur before VP-fronting, a syntactic operation. Postsyntactic application of GenHM would incorrectly predict that  $T_m$  can never be present in the fronted VP. On the other hand, the observed feeding of inflection doubling by GenHM follows from cyclicity if GenHM is syntactic.

We propose that languages with true infinitives or bare verbs in predicate clefts differ from Swedish and Yiddish only in the way in which the [O] feature of  $T_m$  affects its pronunciation. In Polish (and other Slavic languages), the fronted verb is a true infinitive: the exponent of  $T_m$  is the infinitival suffix, and the root does not show tense/agreement-conditioned allomorphy (82). We propose that in this case, [O] triggers feature impoverishment deleting tense and agreement

Table 1: Typology of predicate clefts based on spellout of orphan  $T_m$

	Swedish	Yiddish	Slavic/Hebrew	English
[O] on $T_m$	ignored	forces the elsewhere allomorph of T	triggers feature impoverishment	triggers obliteration
Root allomorphy?	yes	yes	no	no
Form of fronted verb	finite	pseudo-infinitive	true infinitive	bare

features from  $T_m$ . The node then surfaces in its elsewhere form – the infinitival suffix, and the root in its infinitival-triggered allomorph.

- (82) {**?By-ć** / **\*jeste-ć**} w domu, jeste-śmy.  
 be-INF / be.PRS-INF in house, be.PRS-1PL

‘As for being at home, we are.’

Polish

- (83) [VP V ... ] [TP T [VP[-P] V[-P] ... ]]

Finally, the fronted verb in English has no inflectional morphology whatsoever. The effect an orphan feature on  $T_m$  in English was discussed in subsection 4.1, where we proposed that [O] triggers obliteration of  $T_m$  in English, giving rise to a bare verb form in *do*-support contexts. Similarly, VP-fronting (84) creates a chain with an orphan  $T_m$  in the higher VP copy (85), triggering  $T_m$  obliteration.

- (84) {**Go/\*Went**}, he did.

- (85) [VP V\* ... ] [TP T [VP[-P] V\*[-P] ... ]]

Like impoverishment, obliteration bleeds root allomorphy, and the features of  $T_m$  have no effect on the exponence of the fronted verb.<sup>60</sup>

The four languages we discussed exemplify different degrees to which an orphan feature can affect the spellout of a node. In Swedish, [O] on  $T_m$  is ignored; in Yiddish, it triggers defective pronunciation of  $T_m$ ; in Polish, it triggers impoverishment of tense and agreement features; in English, it causes obliteration of the entire  $T_m$  node. This typology is summarized in table 1.

We argued in this section that, even though fronted predicates are often inflectionally deficient, there is evidence that the fronted verb contains the inflectional morpheme. These facts support a particular aspect of GenHM: a unification of upward and downward displacement implemented as sharing of an M-value by multiple syntactic terminals. It is this sharing that predicts the presence of a morphological  $T_m$  node in the fronted VP.<sup>61</sup> The usual deficiency of this node crosslinguistically

<sup>60</sup>Although many speakers do reject inflected fronted verbs, as in (84), examples of this type are in fact widely attested, as discussed in Thoms and Walkden 2018:13–18 and references cited there. It thus seems that  $T_m$ [O] does not always have defective pronunciation in English, at least for some speakers.

<sup>61</sup>GenHM thus differs from Harizanov and Gribanova’s (2018) amalgamation, as the latter involves actual displacement instead of sharing.

is also predicted by our theory since  $T_m$  in the fronted VP is an orphan, which affects its spellout to various degrees.

Absent in our discussion above is the possibility that there might also be variation in the pronunciation of  $V_m[O]$ . In all languages with such a morphological terminal that we have studied (English, Monnese, and MSc),  $V_m[O]$  invariably surfaces as defective *do*. The predictions for a language in which  $[O]$  has no effect on the spellout of  $V_m$  are somewhat complex.  $V_m$  can only become an orphan if the corresponding syntactic terminal is strong ( $V^*$ ), by Chain Splitting. In contrast,  $T_m$  arises automatically in all languages with predicate clefting that involve a GenHM relation between T and V, regardless of the strength of V (e.g. all languages in table 1). Hence, for  $V_m[O]$  to be detected at all in a  $V^*$  language, it has to have Split-by-deletion or Split-by-intervention (or both). In the former case, if  $V_m[O]$  did not have defective pronunciation, the result would be a  $V^*$  language with V-stranding under VPE and predicate clefting, and thus very similar to a language with no  $V^*$ . Perhaps more interestingly, if the language had Split-by-intervention, the result would be verb doubling in contexts such as negation or subject-auxiliary inversion. The absence in our (limited) database of languages with this profile might be due to several factors. First, since  $T_m[O]$  is crosslinguistically more common than  $V_m[O]$ , the former is thus expected to more fully instantiate the predicted typology of spellouts of orphan morphological terminals. Second, due to the markedness of strength, languages in which V is strong are themselves expected to be rare with respect to those in which it is weak (see discussion in subsection 4.3), which further reduces the potential database of relevant languages. We leave further exploration of these questions for future research.

## 6 Conclusion

The theory of head displacement proposed here unifies upward and downward head displacement under a single syntactic operation of GenHM. The effect of upward or downward displacement is postsyntactic, involving a high or low spellout of a single complex head. The proposed unification is motivated by the fact that upward and downward head displacement share fundamental properties: i) they create identical, Mirror-Principle-obeying complex heads (evidenced by the morphophonology of Ndebele relative prefixes), ii) they both feed further upward displacement (giving rise to apparent long head movement in MSc) and iii) they are blocked in the same syntactic configurations (negation blocking both T-to-C and C-to-T displacement in Romance imperatives). We argued that differences between upward and downward displacement (at least in the case of *do*-support) are postsyntactic asymmetries, and thus do not provide evidence that upward and downward displacement are distinct in narrow syntax. Finally, GenHM derives both verb and inflection doubling in predicate clefts, made possible by the feature-sharing implementation offered here.

The GenHM theory takes a particular stand in the debate on the proper classification of displacement phenomena in language. It unifies different types of head displacement to the exclusion of phrasal movement. We concentrated on providing arguments for this unification, thus making an indirect argument against assimilating upward head displacement to phrasal movement. We believe that direct arguments against such an assimilation can be made, as well. There exist (at least) two puzzling asymmetries between upward head displacement and phrasal movement. First, they often impose different identity requirements for ellipsis licensing. Traces of phrasal movement are ignored by the calculation of identity, allowing a mismatch between an antecedent phrase and

a phrase moved out of the ellipsis site (Merchant 2001, Goldberg 2005, Saab 2008). In contrast, a head moved out of an elided constituent has been shown to require an identical antecedent in many languages (McCloskey 1991, 2011, Goldberg 2005, Saab 2008, Gribanova 2013).<sup>62</sup> And second, the two types of movement appear to have different rules governing the spellout of their traces/lower copies. This can be seen in V-stranding VP fronting (discussed in sections 4 and 5): the trace of a verb is pronounced in the fronted remnant, giving rise to verb doubling; on the other hand, an extracted DP (e.g. a subject or object) can only be pronounced in the matrix clause and cannot have a double in the fronted VP (Gärtner 1998, Abels 2001, Nunes 2004, Landau 2006, Vicente 2007, LaCara 2016). These facts show that upward head displacement does not create traces or copies of the same kind as phrasal movement and thus support their dissociation, as is done in the GenHM framework. In fact, our theory predicts the spellout asymmetry between upward head displacement and phrasal movement in VP fronting as only phrasal movement chains involve assignment of [-P] to lower copies (for explicit derivations, see Appendix B).

---

<sup>62</sup>Recent literature shows that not all cases of head movement are subject to strict identity (Santos 2009, Lipták 2013, Gribanova 2013, 2017, Merchant 2018). We assume, following Gribanova (in prep), that these involve head movement that arises via an operation leaving traces/copies, allowing for the kind of mismatches found in phrasal movement. Strict identity is found in head displacement that's due to a different operation than phrasal movement, including our GenHM or Harizanov and Gribanova's Amalgamation. For a different analysis in this spirit (though assuming traditional Head Movement) see Saab 2008:348–385.



## APPENDIX A: Phase extension and Holmberg’s Generalization

The Minimalist literature contains several related proposals to the effect that upward head displacement (formalized as Head Movement) licenses phrasal movements that are otherwise not possible. All these proposals have in common the hypothesis that upward head displacement of the head  $H$  of a phase  $P$  to a higher head extends the phase defined by  $H$ , so that extraction of elements from  $P$  that is otherwise banned by Chomsky’s (2000) Phase Impenetrability Condition (PIC) is made possible. We refer to this family of phenomena as *phase extension*, following den Dikken (2006:81–152, 2007). Other accounts along these lines include Gallego’s (2006) phase sliding (see also Gallego and Uriagereka 2007) and Bošković’s (2015) phase collapsing. See also Chomsky 1993:13–19 and Fox and Pesetsky 2005 for related proposals that do not involve redefining phase boundaries.

Under GenHM, phase extension can be implemented in two different ways. First, we can supplement our analysis with the proposal that, along the lines of the works cited above, the boundaries of a phase are redrawn when the head of the phase establishes a GenHM relation with a higher head. This would predict that downward and upward head displacement would have the same phase-extending capabilities, since they are the result of the same syntactic operation. A second possibility is that phase extension is a postsyntactic effect, which predicts that downward and upward head movement behave differently with respect to phase extension, since, under our analysis, downward and upward head displacement have different postsyntactic properties. Following Fox and Pesetsky 2005, we claim that the latter account is correct, by concentrating on the set of phenomena that fall under Holmberg’s Generalization (Holmberg 1986:165–240, Vikner 2005).<sup>63</sup> The rationale behind focussing on Holmberg’s Generalization is that it is the only detailed case study in which upward and downward head displacement have been compared with respect to phase extension in a single language or language family: in MSc, upward displacement of the main verb licenses object shift, but downward displacement to the verb does not. As argued in detail in Fox and Pesetsky 2005 (based in large part on data in Holmberg 1999), the crucial difference between upward and downward displacement that results in the licensing of object shift has to do with postsyntactic linearization. As we show below, Fox and Pesetsky’s (2005) cyclic linearization account of Holmberg’s Generalization is compatible with GenHM, which we take to be further evidence for the view of head displacement adopted here.

One of the basic contrasts covered by Holmberg’s Generalization is the following. In a V2 sentence in which the main verb is in C due to upward head displacement, the verb’s object can be shifted outside the VP to the left of adverbs such as negation (86), but in a non-V2 sentence (87), the main verb stays in VP, and object shift is not possible (we represent unpronounced positions in head chains as traces for expository purposes only).

- (86) Jag kysste **henne** inte [VP  $t_{\text{kysste}}$   $t_{\text{henne}}$  ]  
I kissed her not

‘I didn’t kiss her.’

Swedish (Holmberg 1999:1)

- (87) \*... att jag **henne** inte [VP kysste  $t_{\text{henne}}$  ]  
that I her not kissed

---

<sup>63</sup>Holmberg (1986) refers to the generalization as the *phonetic adjacency condition*. The first use of Holmberg’s Generalization in this sense is in Collins and Thráinsson 1993:135.

‘... that I didn’t kiss her.’

Swedish (Holmberg 1999:1)

As shown in Holmberg 1986, 1999, this correlation between the possibility of object shift and the position of the main verb outside VP is only partial, and part of a more general pattern of order preservation: all VP-internal material that precedes an object in a sentence without object shift must also precede the object in a corresponding sentence in which the object is shifted. In the examples above, the relevant VP-internal material is the main verb: if the verb surfaces in C, object shift preserves the base verb-object order (86), but if the verb surfaces in VP, object shift reverses the order, which is not licit (87). Thus, the explanation for the correlation between the directionality of head displacement of the verb and object shift has to do with the surface effect of the displacement, and not directly with the specific syntactic operation underlying it.

This predicts that upward head displacement of the verb is neither sufficient, since other VP-internal material may contribute to blocking object shift, nor necessary, since syntactic operations other than head displacement may contribute to preserving the base verb-object order. Both predictions are confirmed, as shown in Holmberg 1986, 1999, and Fox and Pesetsky 2005.

Fox and Pesetsky (2005) account for these patterns based on the hypothesis that postsyntactic linearization is done cyclically, that is, it is interleaved with the syntactic derivation at particular structural points (this is their implementation of Chomsky’s (2000) derivation by phase). These *cyclic spellout domains* include VP and CP: as the syntax incrementally builds clause structure, it ships the structure to be processed postsyntactically whenever it constitutes a spellout domain. Postsyntactic processing includes linearization of the syntactic objects in the spellout domain, and, crucially, the linear order of elements determined at a given application of Spellout is preserved in later stages in the derivation. Application of Spellout in higher domains may add other linear relations, but never delete or alter previously established ones. This derives order preservation in the particular case of object shift, under the assumption that this operation involves direct extraction of the object to its VP-external surface position, that is, it does not involve an intermediate VP-internal step. When VP is spelled out, the relative order of its constituents is fixed; in particular, any element that precedes the object at this stage (e.g. the verb) must do so as well at later applications of Spellout. Thus, if the object moves out of the VP, any such element must displace to an even higher position, in order to be consistent with the linear order fixed at the VP domain.

This account of Holmberg’s Generalization does not rely on the specific syntactic mechanism underlying head displacement, but on its effect on linearization. The contrast between upward and downward head displacement observed in (86–87) is simply due to the fact that the verb precedes the shifted object under upward displacement, but follows it under downward displacement. The analysis is thus compatible with GenHM, under the hypothesis that Head Chain Pronunciation is part of the process of postsyntactic linearization. When the VP is spelled out in both (86) and (87),  $V^*$  is not in a GenHM relation with any higher head, and the order verb-object is fixed (recall from subsection 3.2 that V is strong in MSc, and so is C in V2 sentences).<sup>64</sup>

(88) [VP  $V^*$  Obj ]

⋮  
 $V_m$

Ordering imposed at VP:  $V_m \prec$  Obj

---

<sup>64</sup>In the representations below,  $x < y$  denotes ‘x precedes y’, and we ignore the ordering of phonetically null elements.

In the CP domain, the object is extracted from VP, and  $V^*$  enters into a GenHM relation with T. No other relevant operations apply in a non-V2 sentence (87), and since  $V^*$  is strong, the  $[V_m-T_m]$  complex is spelled out in  $V^*$  (i.e. downward head displacement):

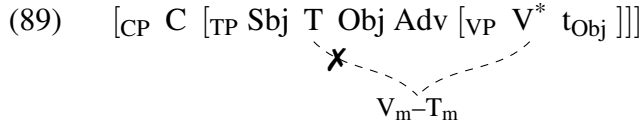

Ordering imposed at VP:  $V_m \prec Obj$  (from (88))

Ordering imposed at CP:  $C_m \prec Sbj \prec Obj \prec Adv \prec V_m \prec T_m$

This yields an ordering conflict in which the verb both precedes and follows the object, resulting in ungrammaticality. On the other hand, in a V2 sentence (86), T enters into an additional GenHM relation with  $C^*$ , forming a complex head  $[V_m-T_m-C_m]$  that is spelled out in  $C^*$ , as the latter is strong:

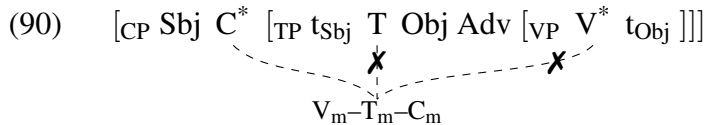

Ordering imposed at VP:  $V_m \prec Obj$  (from (88))

Ordering imposed at CP:  $Sbj \prec V_m \prec T_m \prec C_m \prec Obj \prec Adv$

No ordering conflict arises, since, in particular, the verb is required to precede the object at both spellout domains.

To conclude, to the extent that upward and downward head displacement display asymmetries in their ability to license phrasal movements, these are arguably due to their differing effects on linear order, not to any alleged differences in their syntactic derivations. This is precisely as predicted by the theory of GenHM, in which upward and downward head displacement only differ with respect to postsyntactic linearization.

## APPENDIX B: The spellout of head chains and phrasal chains

The crosslinguistic typology of VP fronting has revealed an asymmetry between phrasal movement and head movement: traces of head movement are doubled in the fronted VP (91), but traces of phrasal movement are not (92).

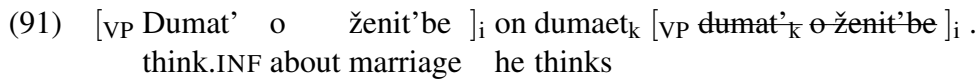

'He thinks about marriage'

(Harizanov and Gribanova 2017, (10))

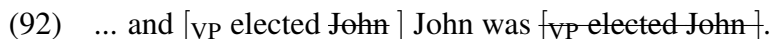

This asymmetry can be further seen in Polish, e.g. in a sentence involving object topicalization and subsequent VP fronting:



Elect Marek, maybe they will.

(Polish)

In (93), both the verb and the object vacate the VP. However, only the verb is pronounced in the fronted VP, creating verb doubling. Similar doubling is not possible for the object.

Assuming the Copy Theory of Movement and Chain Reduction (Chomsky 1993, Nunes 1995), the fronted copy of the verb in (91) is expected to undergo deletion by the same mechanism that deletes the fronted copy of *John* in (92). The occurrence of doubling has received two types of account. One type of approach takes the spellout asymmetry in head- and phrasal movement chains as evidence that the two processes are not the same operation (LaCara 2016, Harizanov and Gribanova 2017, Hein 2018), and it is the stand we take. The other family of approaches maintain that head movement and phrasal movement are both Internal Merge, and the asymmetry is due to special properties of head movement chains. For instance, Bastos (2001), Nunes (2004), Bošković and Nunes (2007) propose that head movement may result in morphological fusion of the moved head with the target head, which prevents Chain Reduction from applying, which in turn causes doubling. Landau (2006) attributes the appearance of verb doubling in Hebrew to prosodic constraints which require the fronted, topicalized copy of the verb to be overt. On the other hand, both Saab (2008, 2017) and Preminger (2019) derive doubling from copy-deletion algorithms that are specific for heads, and may produce either doubling or deletion, depending on the syntactic context in which they apply.

In our theory, the basis for deriving verb doubling is the proposal that GenHM is not the same operation as phrasal movement. Phrasal movement creates type identical copies, while GenHM does not – rather, it creates a *token identical shared* M-value (as detailed in section 2). For this reason, mechanisms deleting copies, such as Chain Reduction, do not apply to head chains. Head displacement is governed by a different spellout algorithm, called Head Chain Pronunciation, which is part of Linearization (94).

(94) *Head Chain Pronunciation*

Delink all positions in a head chain except:

- a. the highest strong position, if any;
- b. otherwise, the highest position.

For phrasal movement chains, we proposed that copy deletion is part of the Move operation (instead of adopting Nunes' (1995) Chain Reduction). Thus, Move is as operation with three components: *Copy*, *Merge* and *Delete* (95) (adapting ideas in Saab 2008, 2017).

(95)  $\text{Move}(\alpha, \beta)$ , where  $\alpha$  is a syntactic object containing  $\beta$

- a. *Copy*: create a type-identical copy of  $\beta$ ,  $\beta^+$
- b. *Merge*: merge  $\beta^+$  and  $\alpha$
- c. *Delete*: assign [-P] to  $\beta$

[-P] is a feature which makes the terminal node invisible to Vocabulary Insertion, effecting deletion of the lower copy.

Below, we demonstrate how copy deletion of movement interacts with Head Chain Pronunciation to derive the spellout asymmetry between heads and phrases discussed above. We do so by presenting a step-by-step derivation of (93). First, syntactic operations applying cyclically – in this case, GenHM and two instances of Move (96-100).

(96) GenHM between V and T

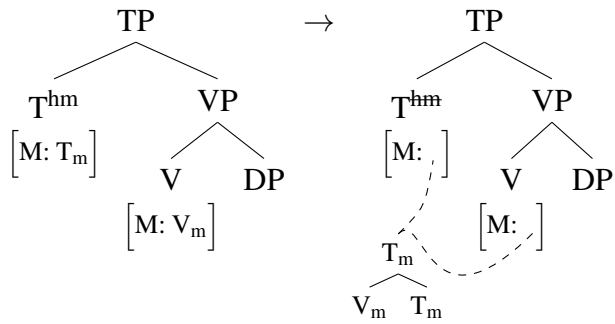

(97) Object topicalization: Merge Top, Copy object DP

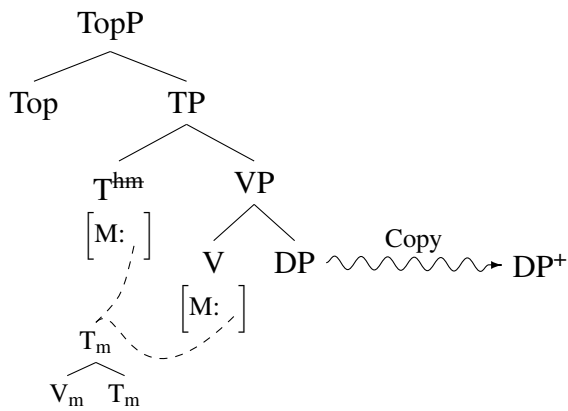

(98) Object topicalization: Merge(TopP, DP+), assign [-P] to DP

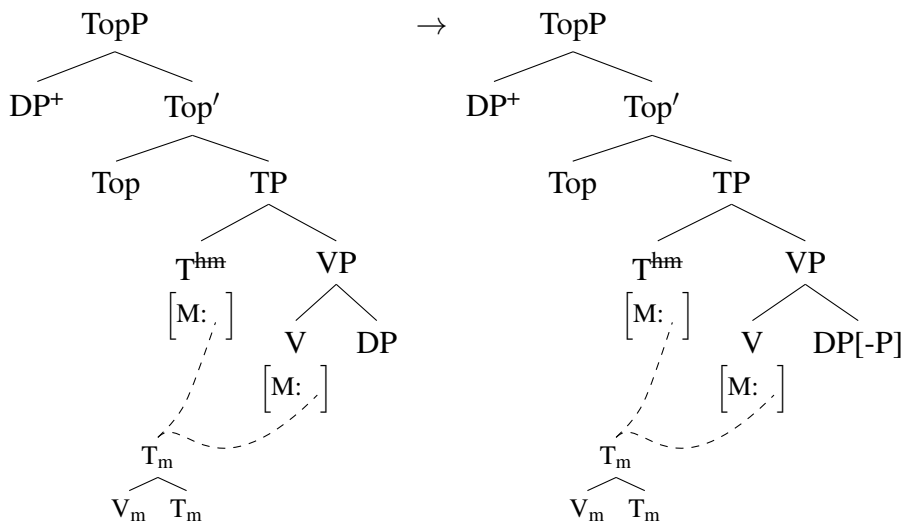

(99) VP Fronting: Merge C, Copy VP

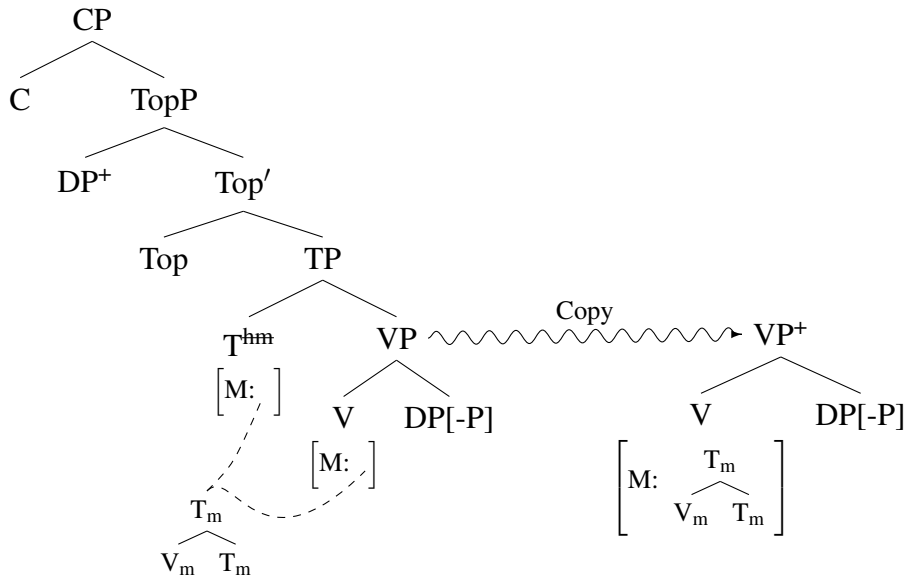

(100) VP Fronting: Merge (CP,VP+), assign [-P] to VP

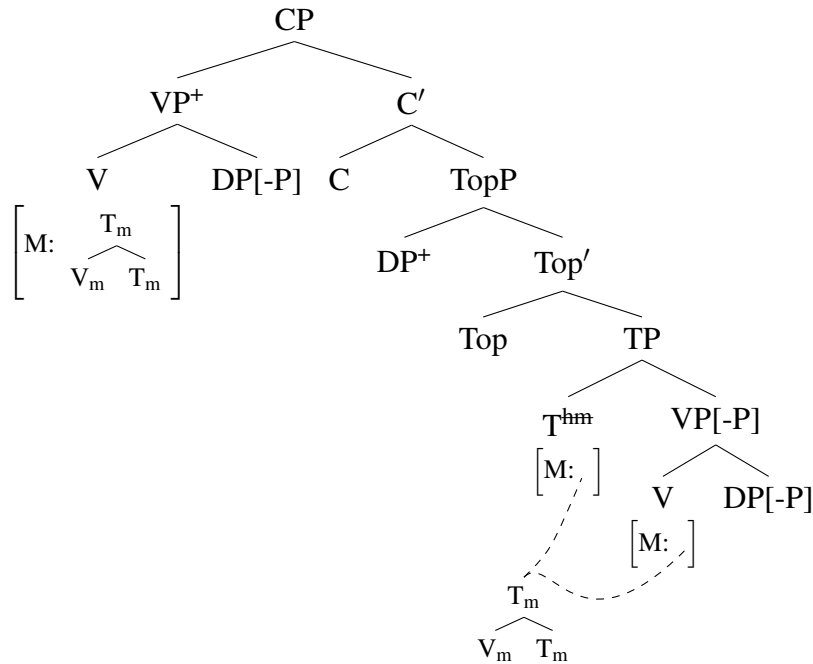

Under the proposed definition of Move, where [-P] assignment is part of the operation, the object DP is marked for deletion (assigned [-P]) immediately after its copy is merged in a higher position. Since DP movement derivationally precedes VP movement in this case, the VP copy created in (99) and merged in (100) contains an object DP that's already marked with [-P]. Thus, obligatory non-pronunciation of phrasal movement "traces" in VP-fronting follows from cyclicity of syntactic operations. (This extends to other instances of remnant movement).

The structure in (100) is the input to PF rules, which include Head Chain Pronunciation followed by Vocabulary Insertion. Due to syntactic VP copying, the structure contains two head



chains with a type-identical M-value, and Head Chain Pronunciation applies to each independently, giving rise to verb doubling. The lower head chain is pronounced in T, the highest position, while the higher chain (inside the fronted VP) is pronounced with in V, the only syntactic terminal it is associated with.

The account of verb doubling presented above shares the basic idea with [LaCara 2016](#), [Harizanov and Gribanova 2017](#), [Hein 2018](#) in that, unlike phrasal movement, head displacement does not create copies that could then undergo deletion. A difference between those accounts and ours is that GenHM is syntactic, while these authors propose postsyntactic head displacement operations (see section 5 for evidence that it is syntactic – it must precede VP fronting to give rise to inflection doubling).

On the present account, every instance of VP fronting will produce verb doubling if there is GenHM with a head external to the VP. Remnant VP-fronting is, however, not the only way in which so called predicate clefts arise. Another mechanism that has been claimed to produce them is long head movement of the verb (i.a. [Koopman 1984](#), [Lema and Rivero 1990](#), [Embick and Izvorski 1997](#), [Landau 2006](#), [Vicente 2007](#)). We follow previous literature in treating long head movement on a par with phrasal movement, i.e. as Move (it cannot be produced by GenHM, which is strictly local). Since long head movement is an operation that creates copies, the regular copy deletion mechanism applies. As with VP fronting, long verb movement gives rise to verb doubling if V is related by GenHM with a higher head.

- (101) *likro, hu kara et ha-sefer.*  
 read.INF he read ACC the-book  
 ‘As for reading, he read the book.’

Hebrew ([Landau 2006:50](#))

- (102) GenHM between V and T

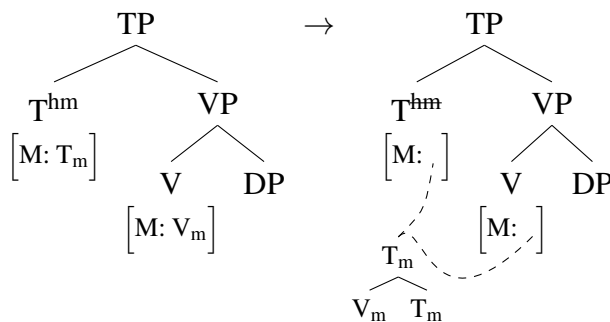

(103) Long V Movement: Merge C, Copy V

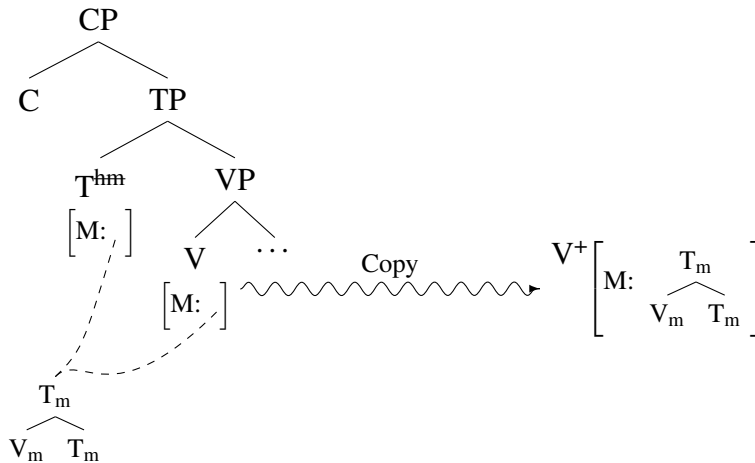

(104) Long V Movement: Merge (CP, V<sup>+</sup>), assign [-P] to V

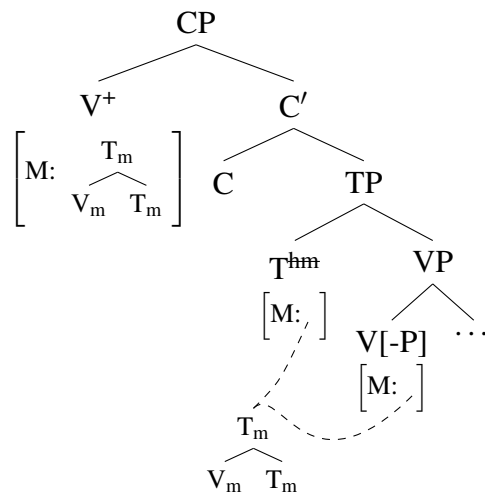

Like VP movement, bare V movement creates a type-identical copy of the verb and its M-value. Thus bare V fronting gives rise to verb doubling for the same reasons as VP fronting, outlined above.<sup>65</sup> Furthermore, our theory provides a unified account of why  $T_m$  is pronounced deficiently (as infinitival inflection) in the higher copy in both V- and VP-fronting. As discussed in section 4, the PF rule of *Orphan Assignment* assigns the [O] feature to any morphological terminal  $X_m$  that's not associated with the corresponding terminal X.  $T_m$  is such a morphological terminal in both the VP- and V-fronting cases.

<sup>65</sup>Hein (2018) argues that, unlike VP fronting, bare V fronting can only result in doubling, and never in *do*-support. He implements it by stipulating that copies of long head movement are immune to the copy deletion algorithm that applies to phrases, and thus always gives rise to doubling. If the generalization he provides is indeed true, we could introduce a similar stipulation in the definition of Move. There is, however, evidence that long head movement can result in deletion of lower copies, e.g. in participle fronting in Slavic (Lema and Rivero 1990, Embick and Izvorski 1997).

## References

- Abels, Klaus. 2001. The predicate cleft construction in Russian. In *Formal Approaches to Slavic Linguistics: The Bloomington meeting 2000*, ed. by Steven Franks, Tracy H. King, and Michael Yadroff, 1–18. Ann Arbor: University of Michigan, Michigan Slavic Publications.
- Adger, David, Daniel Harbour, and Laurel Watkins. 2009. *Mirrors and microparameters: Phrase structure beyond free word order*. Cambridge: Cambridge University Press.
- Aelbrecht, Lobke. 2010. *The syntactic licensing of ellipsis*. Amsterdam: John Benjamins.
- Anderson, Stephen. 2016. Romansh (Rumantsch). In *The Cambridge handbook of morphology*, ed. by Andrew Hippisley and Gregory Stump, 588–608. Cambridge: Cambridge University Press.
- Arregi, Karlos, and Andrew Nevins. 2007. Obliteration vs. impoverishment in the Basque g-/z-Constraint. In *Proceedings of the 30th Annual Penn Linguistics Colloquium*, ed. by Tatjana Scheffler, Joshua Tauberer, Aviad Eilam, and Laia Mayol. Philadelphia: Penn Linguistics Club, University of Pennsylvania.
- Arregi, Karlos, and Andrew Nevins. 2012. *Morphotactics: Basque auxiliaries and the structure of Spellout*. Dordrecht: Springer.
- Baker, Mark. 1985. The Mirror Principle and morphosyntactic explanation. *Linguistic Inquiry* 16:373–415.
- Baker, Mark. 1988. *Incorporation: A theory of grammatical function changing*. Chicago: University of Chicago Press.
- Baker, Mark. 2003. Agreement, dislocation, and partial configurationality. In *Formal approaches to function in grammar: In honor of Eloise Jelinek*, ed. by Andrew Carnie, Heidi Harley, and MaryAnn Willie, 107–132. Amsterdam: John Benjamins.
- Barrie, Michael. 2017. Head Movement as feature geometry growth. *Studies in Generative Grammar* 27:779–810.
- Bartos, Huba. 2000. VP-ellipsis and verbal inflection in Hungarian. *Acta Linguistica Hungarica* 47:3–23.
- Bastos, Ana Cláudia Pinto. 2001. Fazer, eu faço! Topicalização de constituintes verbais em Português Brasileiro. Master's thesis, Universidade Estadual de Campinas.
- Benincá, Paola, and Cecilia Poletto. 2004. A case of *do*-support in Romance. *Natural Language and Linguistic Theory* 22:51–94.
- Bentzen, Kristine, Jason Merchant, and Peter Svenonius. 2013. Deep properties of surface pronouns: Pronominal predicate anaphors in Norwegian and German. *Journal of Comparative Germanic Linguistics* 16:97–125.
- den Besten, Hans. 1983. On the interaction of root transformations and lexical deletive rules. In *On the formal syntax of the Westgermania*, ed. by Werner Abraham, 47–131. Amsterdam: John Benjamins.
- Bjorkman, Bronwyn. 2011. BE-ing default: The morphosyntax of auxiliaries. Doctoral dissertation, MIT, Cambridge, MA.
- Bobaljik, Jonathan. 1995. Morphosyntax: The syntax of verbal inflection. Doctoral dissertation, MIT, Cambridge, MA.
- Bobaljik, Jonathan. 2000. The ins and outs of contextual allomorphy. In *Proceedings of the Maryland Mayfest on Morphology 1999*, ed. by Kleanthes Grohmann and Caro Struijke, 35–71. College Park: University of Maryland, Department of Linguistics.
- Borsley, Robert, and Maria-Luisa Rivero. 1994. Clitic auxiliaries and incorporation in Polish.

- Natural Language and Linguistic Theory* 12:373–422.
- Bošković, Željko, and Jairo Nunes. 2007. The Copy Theory of Movement: A view from PF. In *The Copy Theory of Movement*, ed. by Jairo Nunes and Norbert Corver, number 107 in *Linguistics Today*, 13–74. Oxford: Blackwell Publishers.
- Bošković, Željko. 2015. From the Complex NP Constraint to everything: On deep extractions across categories. *The Linguistic Review* 32:603–669.
- Bresnan, Joan, and Sam Mchombo. 1987. Topic, pronoun, and agreement in Chicheŵa. *Language* 63:741–782.
- Brody, Michael. 1997. Perfect chains. In *Elements of grammar: Handbook in Generative Syntax*, ed. by Liliane Haegeman, 139–167. Dordrecht: Springer.
- Brody, Michael. 2000. Mirror Theory: Syntactic representation in Perfect Syntax. *Linguistic Inquiry* 31:29–56.
- Bruening, Benjamin. 2010. Language-particular syntactic rules and constraints: English locative inversion and *do*-support. *Language* 86:43–84.
- Cable, Seth. 2004. Predicate clefts and base-generation: Evidence from Yiddish and Brazilian Portuguese. Ms., MIT, Cambridge, MA. Available at <http://people.umass.edu/scable/papers/Yiddish-Predicate-Clefts.pdf>.
- Calabrese, Andrea, and Diego Pescarini. 2014. Clitic metathesis in the friulian dialect of forni di sotto. *Probus* 26:275–308.
- Cheng, Lisa. 2006. Decomposing Bantu relatives. In *NELS 36: Proceedings of the thirty-sixth annual meeting of the North East Linguistic Society, Volume One, University of Massachusetts Amherst, October 28–30, 2005*, ed. by Christopher Davis, Amy Rose Deal, and Yuri Zabbal, 197–215. Amherst: University of Massachusetts, Graduate Linguistic Student Association.
- Cheng, Lisa, and Laura Downing. 2009. Where’s the topic in Zulu? *The Linguistic Review* 26:207–238.
- Chomsky, Noam. 1957. *Syntactic structures*. The Hague: Mouton.
- Chomsky, Noam. 1993. A Minimalist Program for linguistic theory. In *The view from Building 20: Essays in linguistics in honor of Sylvain Bromberger*, ed. by Kenneth Hale and Samuel Jay Keyser, 1–52. Cambridge, MA: MIT Press.
- Chomsky, Noam. 1995. *The Minimalist Program*. Cambridge, MA: MIT Press.
- Chomsky, Noam. 2000. Minimalist inquiries: The framework. In *Step by step: Essays on minimalist syntax in honor of Howard Lasnik*, ed. by Roger Martin, David Michaels, and Juan Uriagerka, 89–115. Cambridge, MA: MIT Press.
- Chomsky, Noam. 2001. Derivation by phase. In *Ken Hale: A life in language*, ed. by Michael Kenstowicz, 1–52. Cambridge, MA: MIT Press.
- Collins, Chris, and Joachim Sabel. 2015. A C/I-interface constraint on remnant movement. In *Remnant movement*, ed. by Günther Grewendorf, 93–131. Berlin: De Gruyter Mouton.
- Collins, Chris, and Edward Stabler. 2016. A formalization of minimalist syntax. *Syntax* 19:43–78.
- Collins, Chris, and Höskuldur Thráinsson. 1993. Object shift in double object constructions and the theory of case. In *Papers on case and agreement II*, ed. by Colin Phillips, 131–174. Cambridge, MA: MIT, MIT Working Papers in Linguistics.
- Davis, Lori, and Ellen Prince. 1986. Yiddish verb-topicalization and the notion ‘lexical integrity’. In *Proceedings of CLS 22*, ed. by Anne Farley, Peter Farley, and Karl-Eric McCullough, 90–97. Chicago: University of Chicago, Chicago Linguistic Society.
- Demuth, Katherine, and Carolyn Harford. 1999. Verb raising and subject inversion in Bantu rela-

- tives. *Journal of African Languages and Linguistics* 20:41–62.
- Diercks, Michael. 2010. Agreement with subjects in Lubukusu. Doctoral dissertation, Georgetown University, Washington D.C.
- den Dikken, Marcel. 2006. *Relators and linkers: The syntax of predication, predicate inversion, and copulas*. Cambridge, MA: MIT Press.
- den Dikken, Marcel. 2007. Phase Extension: Contours of a theory of the role of head movement in phrasal extraction. *Theoretical Morphology* 33:1–41.
- Doron, Edit. 1999. V-Movement and VP ellipsis. In *Fragments: studies in ellipsis and gapping*, ed. by Shalom Lappin and Elabbas Benmamoun, 124–140. New York: Oxford University Press.
- de Dreu, Merijn. 2008. The internal structure of the Zulu DP. Master's thesis, Leiden University.
- Embick, David. 2010. *Localism versus globalism in morphology and phonology*. Cambridge, MA: MIT Press.
- Embick, David, and Roumyana Izvorski. 1997. Participle-auxiliary word orders in Slavic. In *Annual Workshop on Formal Approaches to Slavic Linguistics: The Cornell Meeting 1995*, ed. by Wayles Browne, Ewa Dornisch, Natasha Kondrashova, and Draga Zec, 210–239. Ann Arbor: University of Michigan, Michigan Slavic Publications.
- Embick, David, and Rolf Noyer. 2001. Movement operations after syntax. *Linguistic Inquiry* 32:555–595.
- Emonds, Joseph. 1970. Root and structure-preserving transformations. Doctoral dissertation, MIT, Cambridge, MA.
- Emonds, Joseph. 1978. The verbal complex V'-V in French. *Linguistic Inquiry* 9:151–175.
- Fanselow, Gisbert. 2004. Münchhausen-style head movement and the analysis of verb second. In *Three papers on German verb movement*, ed. by Ralf Vogel, 9–49. Linguistics Department, University of Potsdam.
- Fanselow, Gisbert. 2009. Bootstrapping verb movement and the clausal architecture of German (and other languages). In *Advances in comparative Germanic syntax*, ed. by Artemis Alexiadou, 85–118. Amsterdam: John Benjamins.
- Fox, Danny, and David Pesetsky. 2005. Cyclic linearization and syntactic structure. *Theoretical Linguistics* 31:1–45.
- Frampton, John, and Sam Gutmann. 2000. Agreement is feature sharing. Ms., Northeastern University, Boston, MA. Available at <http://mathserver.neu.edu/~ling/pdf/agrisfs.pdf>.
- Gallego, Ángel. 2006. Phase sliding. Ms., Universitat Autònoma de Barcelona.
- Gallego, Ángel, and Juan Uriagereka. 2007. Subextraction from subjects: A Phase Theory account. In *Romance linguistics 2006: Selected papers from the 26th Linguistic Symposium on Romance Languages (LSRL), New Brunswick, March 31–April 2, 2006*, ed. by José Camacho, Nydia Flores-Ferrán, Liliana Sánchez, Viviane Deprez, and María José Cabrera, 155–168. Amsterdam: John Benjamins.
- Gärtner, Hans-Martin. 1998. Review of “The copy theory of movement and linearization of chains in the Minimalist Program”, by Jairo Nunes. *GLOT International* 8:16–20.
- Giusti, Giuliana. 1997. The categorial status of determiners. In *The new comparative syntax*, ed. by Liliane Haegeman, 95–123. London: Longman.
- Goldberg, Lotus. 2005. Verb-stranding VP ellipsis: A cross-linguistic study. Doctoral dissertation, McGill University, Montréal.
- Gribanova, Vera. 2013. Verb-stranding verb phrase ellipsis and the structure of the Russian verbal complex. *Natural Language and Linguistic Theory* 31:91–136.

- Gribanova, Vera. 2017. Head movement and ellipsis in the expression of russian polarity focus. *Natural Language and Linguistic Theory* 35:1079–1121.
- Gribanova, Vera. In prep. Head movement, ellipsis, and identity. Ms. Stanford University.
- Haiman, John, and Paola Benincà. 1992. *The Rhaeto-Romance languages*. London: Routledge.
- Hale, Ken, and Samuel Jay Keyser. 2002. *Prolegomenon to a theory of argument structure*. Cambridge, MA: MIT Press.
- Halle, Morris, and Alec Marantz. 1993. Distributed Morphology and the pieces of inflection. In *The view from Building 20: Essays in linguistics in honor of Sylvain Bromberger*, ed. by Kenneth Hale and Samuel Jay Keyser, 111–176. Cambridge, MA: MIT Press.
- Han, Chung-hye, Jeffrey Lidz, and Julien Musolino. 2007. V-raising and grammar competition in Korean: Evidence from negation and quantifier scope. *Linguistic Inquiry* 38:1–47.
- Harbour, Daniel. 1999. Two types of predicate clefts: Classical Hebrew and beyond. In *Papers on morphology and syntax, Cycle two*, ed. by Vivian Lin, Cornelia Krause, Benjamin Bruening, and Karlos Arregi, 159–175. Cambridge, MA: MIT, MIT Working Papers in Linguistics.
- Harizanov, Boris. 2014. Clitic doubling at the syntax-morphophonology interface: A-movement and morphological merger in Bulgarian. *Natural Language and Linguistic Theory* 32:1033–1088.
- Harizanov, Boris, and Vera Gribanova. 2017. Post-syntactic head movement in russian predicate fronting. Presented at the Linguistic Society of America (LSA) 91.
- Harizanov, Boris, and Vera Gribanova. 2018. Whither head movement? *Natural Language and Linguistic Theory*.
- Harley, Heidi. 2004. Merge, conflation, and head movement: The first sister principle revisited. In *NELS 34: Proceedings of the thirty-fourth meeting of the North East Linguistic Society*. Stony Brook University. Volume One, ed. by Keir Moulton and Matthew Wolf, 239–254. Amherst: University of Massachusetts, Graduate Linguistic Student Association.
- Harley, Heidi. 2013. Getting morphemes in order: merger, affixation, and head movement. In *Diagnosing syntax*, ed. by Lisa L.-S. Cheng and Norbert Corver, 44–74. Oxford: Oxford University Press.
- Harris, James. 1998. Spanish imperatives: Syntax meets morphology. *Journal of Linguistics* 34:27–52.
- Hartman, Jeremy. 2011. The semantic uniformity of traces: Evidence from ellipsis parallelism. *Linguistic Inquiry* 42:367–388.
- Hein, Johannes. 2018. Verbal fronting: Typology and theory. Doctoral dissertation, Leipzig University.
- Henderson, Brent. 2006. The syntax and typology of Bantu relative clauses. Doctoral dissertation, University of Illinois, Urbana-Champaign.
- Henderson, Brent. 2013. Agreement and person in anti-agreement. *Natural Language and Linguistic Theory* 31:453–481.
- Holmberg, Anders. 1986. Word order and syntactic features in the Scandinavian languages and English. Doctoral dissertation, University of Stockholm.
- Holmberg, Anders. 1999. Remarks on Holmberg’s Generalization. *Studia Linguistica* 53:1–39.
- Holmberg, Anders, and Christer Platzack. 1995. *The role of inflection in Scandinavian syntax*. Oxford: Oxford University Press.
- Houser, Michael, Line Mikkelsen, and Maziar Toosarvandani. 2011. A defective auxiliary in Danish. *Journal of Germanic Linguistics* 23:245–298.



- Julien, Marit. 2002. *Syntactic heads and word formation*. Oxford: Oxford University Press.
- Källgren, Gunnel, and Ellen Prince. 1989. Swedish VP-topicalization and Yiddish verb-topicalization. *Nordic Journal of Linguistics* 12:47–58.
- Khumalo, James. 1992. The morphology of the direct relative in Zulu. In *African linguistic contributions: Presented in honour of Ernst Westphal*, ed. by Derek Gowlett, 210–226. Pretoria: Via Afrika.
- Kilbourn-Ceron, Oriana, Heather Newell, Máire Noonan, and Lisa Travis. 2016. Phase domains at PF: Root suppletion and its implications. In *Morphological metatheory*, ed. by Heidi Harley and Daniel Siddiqi, 121–161. Amsterdam: John Benjamins.
- Koopman, Hilda. 1984. The syntax of verbs: From verb movement rules in the Kru languages to Universal Grammar. Doctoral dissertation, Tilburg University.
- Koopman, Hilda, and Anna Szabolcsi. 2000. *Verbal complexes*. Cambridge, MA: MIT Press.
- Kornfeld, Laura, and Andrés Saab. 2004. Nominal ellipsis and Morphological Structure in Spanish. In *Romance languages and linguistic theory 2002: Selected papers from 'Going Romance', Groningen, 28–30 November 2002*, ed. by Reineke Bok-Bennema, Bart Hollebrande, Brigitte Kampers-Manhe, and Petra Sleeman, 183–198. Amsterdam: John Benjamins.
- LaCara, Nicholas. 2016. Verb phrase movement as a window into head movement. In *Proceedings of the LSA, Volume 1*, ed. by Patrick Farrell, 17:1–14. Washington, DC: Linguistic Society of America.
- Laka, Itziar. 1990. Negation in syntax: On the nature of functional categories and projections. Doctoral dissertation, MIT, Cambridge, MA.
- Landau, Idan. 2006. Chain resolution in Hebrew V(P)-fronting. *Syntax* 9:32–66.
- Lasnik, Howard. 1981. Restricting the theory of transformations: A case study. In *Explanation in linguistics: The logical problem of language acquisition*, ed. by Norbert Hornstein and David Lightfoot, 152–173. London: Longman.
- Lechner, Winifred. 2007. Interpretive effects of head movement. <https://ling.auf.net/lingbuzz/000178>.
- Lema, José, and María Luisa Rivero. 1990. Long head movement: HMC vs. ECP. In *Proceedings of NELS 20, Volume 2*, ed. by Juli Carter, Rose-Marie Déchaine, Bill Philip, and Tim Sherer, 333–347. Amherst: University of Massachusetts, Graduate Linguistic Student Association.
- Letsholo, Rose Meleko. 2002. Syntactic domains in Ikalanga. Doctoral dissertation, University of Michigan, Ann Arbor.
- Lipták, Anikó. 2013. The syntax of emphatic positive polarity in Hungarian: evidence from ellipsis. *Lingua* 128:72–92.
- Manzini, Maria, and Leonardo Savoia. 2005. *I dialetti italiani e romanci. Volume III*. Alessandria: Edizioni dell'Orso.
- Marantz, Alec. 1984. *On the nature of grammatical relations*. Cambridge, MA: MIT Press.
- Marantz, Alec. 1988. Clitics, morphological merger, and the mapping to phonological structure. In *Theoretical morphology: Approaches in modern linguistics*, ed. by Michael Hammond and Michael Noonan, 253–270. San Diego, CA: Academic Press.
- Martinović, Martina. 2015. Feature geometry and head-splitting: Evidence from the Wolof clausal periphery. Doctoral dissertation, The University of Chicago.
- Martinović, Martina. To appear. Interleaving syntax and postsyntax: Spell-out before syntactic movement. *Syntax*.
- Martins, Ana Maria. 2007. Double realization of verbal copies in European Portuguese. In *The*

- copy theory of movement*, ed. by Norbert Corver and Jairo Nunes, 78–118. Amsterdam: John Benjamins.
- Matushansky, Ora. 2006. Head movement in linguistic theory. *Linguistic Inquiry* 37:69–109.
- McCloskey, James. 1991. Clause structure, ellipsis and proper government in Irish. *Lingua* 85:259–302.
- McCloskey, James. 2011. The shape of Irish clauses. In *Formal approaches to Celtic linguistics*, ed. by Andrew Carnie, 143–178. New Castle upon Tyne: Cambridge Scholars Publishing.
- Merchant, Jason. 2001. *The syntax of silence: Sluicing, islands, and the theory of ellipsis*. Oxford: Oxford University Press.
- Merchant, Jason. 2013. Voice and ellipsis. *Linguistic Inquiry* 44:77–108.
- Merchant, Jason. 2015. How much context is enough? two cases of span-conditioned stem allomorphy. *Linguistic Inquiry* 46:273–303.
- Merchant, Jason. 2018. Verb-stranding predicate ellipsis in Greek, implicit arguments, and ellipsis-internal focus. In *A reasonable way to proceed: Essays in honor of Jim McCloskey*, ed. by Jason Merchant, Line Mikkelsen, Deniz Rudin, and Kelsey Sasaki, 229–269. University of California eScholarship.
- Migdalski, Krzysztof. 2006. The syntax of compound tenses in Slavic. Doctoral dissertation, LOT, Utrecht University.
- Murguia, Elixabete. 2004. Syntactic identity and locality restrictions on verbal ellipsis. Doctoral dissertation, University of Maryland, College Park.
- Myler, Neil. 2017. Exceptions to the mirror principle and morphophonological “action at a distance”: The role of “word”-internal phrasal movement and spell out. In *The structure of words at the interfaces*, ed. by Heather Newell, Maire Noonan, Glyne Piggott, and Lisa Travis, 100–125. Oxford: Oxford University Press.
- Nevins, Andrew. 2010. Multiple Agree with clitics: Person complementarity vs. omnivorous number. Ms., University College London.
- Nevins, Andrew. 2011. Multiple Agree with clitics: Person complementarity vs. omnivorous number. *Natural Language and Linguistic Theory* 29:939–971.
- Ngonyani, Deo. 1996. VP ellipsis in Ndendeule and Swahili applicatives. In *Syntax at sunset: UCLA working papers in syntax and semantics 1*, 109–128. Los Angeles: University of California, Department of Linguistics.
- Nunes, Jairo. 1995. The copy theory of movement and linearization of chains in the Minimalist Program. Doctoral dissertation, University of Maryland, College Park.
- Nunes, Jairo. 2004. *Linearization of chains and sideward movement*. Cambridge, MA: MIT Press.
- Pesetsky, David, and Esther Torrego. 2007. The syntax of valuation and the interpretability of features. In *Phrasal and clausal architecture: Syntactic derivation and interpretation*, ed. by Simin Karimi, Vida Samiiian, and Wendy Wilkins, 262–294. Amsterdam: John Benjamins.
- Pietraszko, Asia. 2019. Obligatorily CP nominalization in Ndebele. *Syntax* 22:66–111.
- Platzack, Christer. 1986. COMP, INFL, and Germanic word order. In *Topics in Scandinavian syntax*, ed. by Lars Hellan and Kirsti Koch Christensen, 185–234. Dordrecht: Reidel.
- Platzack, Christer. 2012. Cross Germanic variation in the realm of support verbs. In *Comparative Germanic syntax: The state of the art*, ed. by Peter Ackema, Rhona Alcorn, Caroline Heycock, Dany Jaspers, Jeroen Van Craenenbroeck, and Guido Vanden Wyngaerd, 279–310. Amsterdam: John Benjamins.
- Platzack, Christer. 2013. Head movement as a phonological operation. In *Diagnosing syntax*, ed.

- by Lisa Lai-Shen Cheng and Norbert Corver, 21–43. Oxford: Oxford University Press.
- Pollard, Carl, and Ivan Sag. 1994. *Head-driven Phrase Structure Grammar*. Chicago: University of Chicago Press.
- Pollock, Jean-Yves. 1989. Verb movement, Universal Grammar, and the structure of IP. *Linguistic Inquiry* 20:365–424.
- Potsdam, Eric. 1997. NegP and subjunctive complements in English. *Linguistic Inquiry* 28:533–541.
- Preminger, Omer. 2019. What the PCC tells us about ‘abstract’ agreement, head movement, and locality. *Glossa* 4:13.
- Rivero, María Luisa. 1994. Clause structure and V-movement in the languages of the Balkans. *Natural Language and Linguistic Theory* 12:63–120.
- Rivero, María Luisa, and Arhonto Terzi. 1995. V-movement and logical mood. *Journal of Linguistics* 31:301–332.
- Rizzi, Luigi. 1990. *Relativized Minimality*. Cambridge, MA: MIT Press.
- Roberts, Ian. 2010. *Agreement and head movement: Clitics, incorporation, and defective goals*. Cambridge, Mass.: MIT Press.
- Romanello, Emily, and Lori Repetti. 2014. Imperative characteristics in Romance varieties spoken in Italy. *Rivista di Linguistica* 26:135–163.
- Ruda, Marta. 2014. On the v-stranding vp ellipsis analysis of missing objects in polish. In *Proceedings of the Third Central European Conference in Linguistics for Postgraduate Students*, 60–85.
- Russell, Margaret. 2006. The syntax and placement of Wolof clitics. Doctoral dissertation, University of Illinois at Urbana-Champaign.
- Saab, Andrés. 2008. Hacia una teoría de la identidad parcial en la elipsis. Doctoral dissertation, Universidad de Buenos Aires.
- Saab, Andrés. 2017. Varieties of verbal doubling in Romance. *Isogloss* 3:1–42.
- Sailor, Craig. 2009. Tagged for deletion: A typological approach to VP ellipsis in tag questions. Master’s thesis, University of California, Los Angeles.
- Sailor, Craig. 2018. The typology of head movement and ellipsis: A reply to Lipták and Saab (2014). *Natural Language and Linguistic Theory*.
- Santos, Ana Lúcia. 2009. *Minimal answers. Ellipsis, syntax and discourse in the acquisition of European Portuguese*. Amsterdam/Philadelphia: John Benjamins.
- Sibanda, Galen. 2004. Verbal phonology and morphology of Ndebele. Doctoral dissertation, University of California, Berkeley.
- Skinner, Tobin. 2009. Investigations of downward movement. Doctoral dissertation, McGill University, Montréal.
- Stabler, Edward. 2001. Recognizing head movement. In *Logical Aspects of Computational Linguistics, 4th International Conference, LACL 2001 Le Croisic, France, June 27–29, 2001, Proceedings*, ed. by Philippe de Groote, Glyn Morrill, and Christian Retoré, 245–260. Berlin: Springer.
- von Staden, P.M.S. 1973. The initial vowel of the noun in Zulu. *African Studies* 32:163–181.
- Svenonius, Peter. 2016. Spans and words. In *Morphological metatheory*, ed. by Daniel Siddiqi and Heidi Harley, 201–222. Amsterdam: John Benjamins.
- Szabolcsi, Anna. 2011. Certain verbs are syntactically explicit quantifiers. In *Formal semantics and pragmatics: Discourse, context, and models.*, volume 6. Manhattan, KS: New Prairie Press.

- Taraldsen, Knut Tarald. 1985. On verb second and the functional content of syntactic categories. In *Verb second phenomena in the Germanic languages*, ed. by Hubert Haider and Martin Prinzhorn, 7–25. Dordrecht: Foris.
- Taraldsen, Knut Tarald. 2010. The nanosyntax of Nguni noun class prefixes and concords. *Lingua* 120:1522–1548.
- Thoms, Gary. 2012. Verb movement and ellipsis in Scandinavian. Ms., University of Edinburgh.
- Thoms, Gary, and George Walkden. 2018. VP-fronting with and without remnant movement. *Journal of Linguistics*. Online first.
- Travis, Lisa deMena. 1984. Parameters and effects of word order variation. Doctoral dissertation, MIT, Cambridge, MA.
- Travis, Lisa deMena. 2003. Reduplication feeding syntactic movement. In *2003 CLA Conference proceedings*, ed. by Sophie Burelle and Stanca Somesfalean, 236–247. Ottawa: Canadian Linguistic Association.
- Vicente, Luis. 2007. The syntax of heads and phrases: A study of verb (phrase) fronting. Doctoral dissertation, Universiteit Leiden.
- Vikner, Sten. 1995. *Verb movement and expletive subjects in the Germanic languages*. Oxford: Oxford University Press.
- Vikner, Sven. 2005. Object shift. In *The Blackwell companion to syntax*, ed. by Henk van Riemsdijk and Martin Everaert, 392–436. Oxford: Blackwell.
- Visser, Marianna. 2008. Definiteness and specificity in the isiXhosa determiner phrase. *South African Journal of African Languages* 28:11–29.
- Waletzky, Joshua. 1969. Topicalization in Yiddish. BA thesis, University of Chicago, Chicago.
- Wilder, Chris. 1997. Some properties of ellipsis in coordination. In *Studies on Universal Grammar and typological variation*, ed. by Artemis Alexiadou and T. Alan Hall, 59–107. Amsterdam: John Benjamins.
- Zanutini, Raffaella. 1997. *Negation and clausal structure: A comparative study of Romance languages*. Oxford: Oxford University Press.
- Zeller, Jochen. 2004. Relative clause formation in the Bantu languages of South Africa. *Southern African Linguistics and Applied Language Studies* 22:75–93.