

PhD project: LF Impoverishment: Phase 1: Upgrade paper: Why Cannot Case Mark Politeness in Addressee Pronouns?

*Ziren Zhou*¹ ©2018

This paper² discusses *LF Impoverishment*,
an invention of Nevins (2008), aka. *Deprivation*.
This paper makes use of *Phase*, coined by Chomsky.

Keywords: LF Impoverishment, Phase, Polite addressee pronouns

1. Introduction

Polite addressee pronouns (i.e. polite 2nd person singular/non-singular pronouns) are used to address the hearer(s) in a formal situation or when the speaker wants to show respect to the hearer(s). For functional reasons, a pronoun used politely has to be overtly different from pronouns that are used in addressing the hearer in a neutral or informal way (Ackema and Neeleman, 2018). For this purpose, languages make use of two strategies in generating polite addressee pronouns. The first strategy is like that of Mandarin Chinese. It has a dedicated polite singular addressee pronoun *nín*/2nd sg polite, which does not exist elsewhere in the Mandarin pronominal paradigm. Some other languages recruit existing personal pronouns from their pronominal paradigms. For example, Modern Standard German recruits the 3rd person plural pronoun *sie* as a polite addressee pronoun, which is a case of syncretism; French plural addressee pronoun *vous* can be used as singular addressee pronoun in a polite situation, etc.

The aim of this PhD project is to account for the derivation of the typology of polite addressee pronouns by explaining the mismatch between the semantics of polite addressee pronouns and their forms. As mentioned above, for example, the 2nd person singular semantics of the German polite addressee pronoun *sie* is in conflict with its 3rd person plural phonological form. The assumption of this paper is that there is a set of impoverishment rules that manipulate the feature input of personal pronouns from syntax in different manners cross-linguistically, both at LF and at PF, to produce the mismatch between semantic and phonological interpretations.

Johannes Helmbrecht's (2003) work is a valuable typological overview that shows variations of how languages produce polite addressee pronouns. However, Helmbrecht does not offer a formal analysis of their grammatical behaviours. Brown and Levinson (1987) noticed the phenomenon of polite addressee pronouns, but only explained their pragmatic effects on

¹ Ziren Zhou, second year PhD student at University College London.
202, Chandler House, 2 Wakefield Street, WC1N 1PF, London, United Kingdom.
Comments and/or criticisms are most welcome: ziren.zhou.14@ucl.ac.uk

² Many thanks to Klaus Abels, Andrew Nevins, Ad Neeleman, Alec Marantz, Donca Steriade, Coppe van Urk, and Edwin Williams, etc. for comments and/or general encouragements.

regulating social distance. Wechsler's work (e.g. 2011) on agreement mismatch discusses the phenomenon of polite addressee pronouns but only focuses on the distinction between semantic and syntactic agreement. I'm unable to cite any formal analysis in generative linguistics other than Ackema and Neeleman (2018) that provides a theory that derives a typology of polite addressee pronouns, namely one that explains why certain existing personal pronouns of a language could potentially be recruited as polite addressee pronouns and why some others cannot.

Ackema and Neeleman (2018) propose that there is a HON (for 'honorificity') feature in the syntax. For languages like Mandarin Chinese, HON is phonologically spelt out as part of the feature bundle that is realized by the dedicated polite 2nd person singular pronoun *nín*. For languages like Modern Standard German, HON triggers a morphological impoverishment rule that deletes the feature PL on the LF branch and another impoverishment rule that removes features of a pronoun at PF so that the 3rd person plural rather than 2nd person plural pronominal form is phonologically realized. They also account for the language Muna, which uses its 1st person inclusive pronoun as a polite addressee singular pronoun. Most importantly, they predict and account for the fact that it is impossible to recruit first person singular and first person exclusive pronouns as polite addressee pronouns.

The pioneering working done by Ackema and Neeleman (2018) is, however, not an adequate description of the typology of polite addressee pronouns as they have claimed. This PhD project aims to account for a larger typology of polite addressee pronouns (ie. why certain personal pronouns can be recruited as polite addressee pronouns and why some other personal pronouns cannot) than that of Ackema and Neeleman (2018). For example, while Ackema and Neeleman (2018) only analyse why personal pronouns carrying a certain number or person (or a combination of the two) feature can be used as polite addressee pronouns, this paper also account for why personal pronouns carrying a certain gender feature (e.g. Italian), a REFL (for 'reflexive') (e.g. Hungarian) feature and a demonstrative feature (e.g. Sinhalese) can be used as polite addressee pronouns.

Moreover, contrasting with Ackema and Neeleman's (2018) conclusion, which says that it only requires positing the existence of a HON feature, a set of LF/PF impoverishment rules and the internal feature structure of personal pronouns proposed by them to analyse the typology of polite addressee pronouns, I contend that more constraints are needed to account for the derivation of polite addressee pronouns. Specifically, i) the Markedness Constraint: only morphologically marked features can be targets of HON-triggered LF impoverishment rules³; ii) the Locality Constraint: the licensing of HON feature is restricted by a locality condition. Essentially, this paper on the one hand extend their general line of analysis to cases that Ackema and Neeleman (2018) didn't cover. For instance, gender features and possibly other features that might play a role; and the fact that features above DP (e.g. case) cannot mark politeness—Ackema and Neeleman's (2018) analysis is silent about locality. On the other hand, this paper widens the typological data set, which hopefully could be seen as a

³ In fact, this constraint is implied by their analysis because all the features in their analysis are monovalent, therefore any features that are deleted are automatically also marked features. However, due to the limitation of their typology, this point is not salient and general enough in their book. Specifically, LF impoverishment targets in Ackema and Neeleman (2018) is just the number feature PL. With a larger typology like the one in this paper, we'll see later that LF impoverishment targets also include FEM, DU, PACAUL and REFL, which are all morphologically marked features.

serious attempt to test Ackema and Neeleman's hypotheses⁴, subsequently expanding their analysis and generating more predictions of impossible polite pronouns.

According to WALS (the World Atlas of Language Structures) and the typological data I have collected from native speakers so far, apart from having dedicated polite singular/plural addressee pronouns (e.g. Dutch⁵) and recruiting **3rd pl** pronouns (e.g. Modern Standard German), **2nd pl** pronouns (e.g. French) and **1st Inclusive** pronouns (e.g. Muna) as polite addressee singular pronouns, which have been discussed in Ackema and Neeleman (2018), languages also exhibit the following (at least) four more patterns of how polite addressee pronouns are recruited:

- (1) *Polite 2nd sg pronoun is syncretic with 2nd **pl/paucal/dual** pronoun*
e.g. Fijian⁶
- (2) *Polite 2nd sg pronoun is syncretic with **3rd fem** sg pronoun*
e.g. Italian
- (3) *Polite 2nd pronouns are syncretic with **reflexive 3rd***
e.g. Hungarian
- (4) *Polite 2nd sg pronoun is dedicated and it cannot be pluralised⁷.*
e.g. Mandarin Chinese

Observe the bolded features of the source forms of the polite addressee pronouns mentioned above: these features are the mismatching features (or feature values) that contradict the targeted meaning, which is 2nd person and singular number semantics. Since these mismatching features signal the existence of polite addressee pronouns, I describe henceforth these features as 'marking politeness' for convenience's sake. As a first step in the PhD project, the particular puzzle that this upgrade paper aims to solve is: Why cannot case features mark politeness, given that it is one of the most obvious options à priori? My reason for raising this issue is as follows.

A hypothetical scenario would be, for example, if English uses the genitive *your* and German uses the dative *ihm* as polite addressee (subject) pronouns. What is really surprising is that it is not attested in any languages I have looked at so far where case could hypothetically mark politeness in addressee pronouns.

From a theoretical perspective, according to how polite addressee pronouns are formally represented in Ackema and Neeleman's (2018) model, the actual polite interpretation resides in HON. The features that mark politeness are dependent on HON and are not interpreted. One would think that using the feature(s) which has no interpretation to begin with to mark politeness is the optimal strategy. For example, case features. If one adopts this strategy, then there is no need to have special deletion rules post-syntactically to delete mismatching features at LF, and any potential disparities in form and interpretation are avoided. Why

⁴ As a preview, 'hypotheses' here refer to their idea that the special forms of polite addressee pronouns are derived by impoverishment rules at LF and PF.

⁵ Dutch singular polite addressee pronoun is syncretic with plural polite addressee pronoun *u*.

⁶ See for example Corbett (2000: 225) and Schmidt (1988:71).

⁷ I assume that this is potentially due to the fact that both PL and HON are marked features and two marked features resist co-existence. Following the same logic, one could imagine that in languages where the FAM (for 'familiarity') is a marked feature, the familiar addressee pronoun could not be pluralised either, which is born out in Urdu. I will not discuss FAM in detail in this paper but aims to address it in the PhD thesis.

instead would languages prefer using features like FEM (eg. Italian) and PL (eg. Modern Standard German) in the syntax that are normally interpreted, prior to deleting them before interpretation? Thus, this paper treats it as a genuine theoretical question as to why case features are not recruited for marking politeness.

Furthermore, among the 71 languages from WALS that has a politeness distinction in pronouns, it is found that some languages use demonstrative pronouns, reflexive pronouns and status terms as ‘source’ forms of polite addressee pronouns. For example, in Hungarian, reflexive pronouns are used as polite addressee pronouns:

- (5) Ön tanult linguisetikat
 REFL.sg study.3rd.sg linguistics
 ‘you studied linguistics.’ (addressing a singular person politely)
- (6) Ön boldog volt
 REFL.sg happy.sg BE.past.3sg
 ‘you were happy.’ (addressing a singular person politely)
- (7) Önök tanultak linguisetikat
 REFL.pl study.3rd.pl linguistics
 ‘you studied linguistics.’ (addressing a plurality of people politely)
- (8) Önök boldogok voltak
 REFL.pl happy.pl BE.past.3pl
 ‘you were happy.’ (addressing a plurality of people politely)

(Balázs Pográn g c.)

This makes it all the more interesting to ask why case features are not used in marking politeness in polite addressee pronouns, given that a variation of other kinds of features can be used. If features like REFL could be used then the deduction is that the mismatching features are not limited to traditional phi features. Phi features, after all, is but a cover term for person, number, and gender features.

To look for answers as to why case features cannot mark politeness, I hypothesize that this has to do with the internal distribution of pronominal features and the locality condition on the licensing of HON feature, constraining how potential politeness marking features would interact with HON in the syntax within a pronoun. Specifically, I argue that case features cannot interact with HON in the syntax due to the fact that access of HON to case features are ‘blocked’ by the DP/N^{max}P⁸ phase boundary. HON can interact with phi features and other DP internal features like REFL because these features are within the DP/N^{max}P phase.

My argumentation is based on independent evidence for the structure of pronouns. My logic of reasoning in this paper is organized as follows. Firstly, I introduce the internal syntax of polite addressee pronouns in Section 2. In line with Postal’s (1969) proposal on the structure of pronouns, I adopt the idea that a personal pronoun is a DP/N^{max}P. Secondly, I will explain how impoverishment rules (both at LF and PF) derive the typology of polite addressee

⁸ N^{max}P is a label for the complement of D head. See Section 4 for details.

pronouns in Section 3. These impoverishment rules are an extension of initial work by Ackema and Neeleman (2018). For this reason, I will adopt their representation of person and number feature system as well. Thirdly, Section 4 will introduce independent evidence from the literature arguing that DP/N^{maxP} is a phase and case features are outside this phase boundary. Since Phi features and other potential politeness marking features like REFL are assumed to be within the DP/N^{maxP} phase, this explains why only these features can interact with HON in the syntax. Finally, to make the theory developed in this paper more complete, I will discuss one apparent counterexample to my hypothesis, which is case spreading in the DP/N^{maxP}. In the conclusion section of this paper, I will point out what might constitute further problems for the remaining time of the PhD project.

2. The internal syntax of polite addressee pronouns

The idea that pronouns have internal structures composed of multiple levels of projections has been around since at least Postal (1969), where it has been noted that pronouns syntactically behave like DPs in many respects. Postal’s idea was rather subtle: personal pronouns are Ds followed by a null noun and full pronominal expressions are DPs by implication⁹.

Déchaine and Wiltschko (2002) propose that languages have three types of pronouns, each of which is associated with a different layer of projection: pro-DP, pro- ϕ , and pro-NP (9a-c). Putting their view in the backdrop of a late spell-out model like the one adopted in this paper (i.e. Distributed Morphology), I understand their claim that pro- ϕ and pro-NP are subconstituents of pro-DP as a strong implication that the three-tier difference between pro-DP, pro- ϕ , and pro-NP is actually a difference manifested in the spell-out system of pronouns, rather than the compositional structure of pronouns in the syntax. Spell-out system aside, the only pronominal structure that Déchaine and Wiltschko (2002) has actually implied is the DP structure in (9a).

(9) Internal structure of pronouns in Déchaine and Wiltschko (2002)

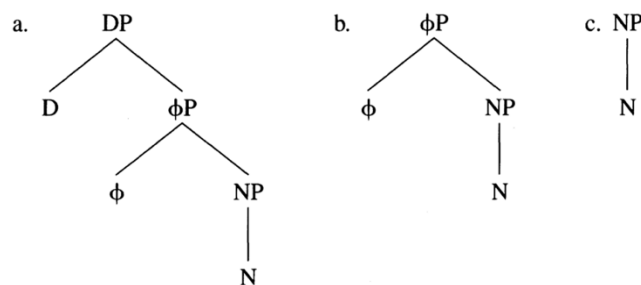

Overall, previous literature has argued that a personal pronoun is either an NP or a full DP (eg. Fukui 1988; Noguchi 1997). Their diagnostic for this distinction is based on modification, ie. pronouns cannot be modified by pronominal adjectives.

(10) a. liǎobùqǐ de tā xiě wán le zhè běn shū
 great DE¹⁰ s/he write finish ASP this NCL_{book} book

⁹ According to Postal (1969), A reflexive personal pronoun like *himself* is a determiner plus a noun *self*.

¹⁰ *De/DE* is a functional word that indicates the adjectivehood of *liǎobùqǐ de/ great*.

- ‘S/he, who is great, finished writing this book.’
- b. liǎobùqǐ de kēxuéjiā xiě wán le zhè běn shū
great DE scientist write finish ASP this NCL_{book} book
 ‘Great scientists finished writing the book.’

(Mandarin Chinese)

- (11) a. *Great he finished writing the book.
 b. Great scientists finished writing the book.

In the Mandarin Chinese example (10), the modifier *liǎobùqǐ de/* great DE can modify the pronoun *tā/ s/he*. In the English example (11), the third person pronoun cannot be modified like a noun can be. This contrast between Mandarin Chinese and English shows that: pronouns like Mandarin *tā/ s/he* is treated as an NP, because a modifier could still be attached somewhere in the DP projection, like the specifier of the NP; pronouns like the English *he* is categorised as a full DP, because there is nowhere to attach a modifier, which seems to be only explicable if the pronoun *he* has fully realised the DP projection. The fact that **The he finished writing the book* where it is ungrammatical to precede the pronoun with a determiner also corroborates this conclusion about English. In fact, Neeleman and Szendrői (2007) argue that sometimes you can see pronouns spell out the largest structure because when you spell out a higher structure, you can’t get modification of lower parts. Suppose you have some pronoun, that contains some AP modifier, but since there is a single phonology for this structure (e.g. *he*), it is impossible to have modification of part of that structure. If, however, you have a language like Chinese or Japanese, where you spell out not the whole pronoun structure but just part of it. Then you could have an AP modifying part of the pronoun (eg. example 10). Pannemann (2007), specifically argues the point that if a word spells out a higher structure then modification of lower part is impossible. Neeleman and Szendrői (2007) have also shown that the cross-linguistic difference between languages that allow radical pro-drop and those that allow pro-drop only in constrained context can be derived from the assumption that pronouns are DPs. I will assume that a pronoun can project a DP as its maximal projection, with special notice that the spell-out system is irrelevant to my discussion.

Following Bittner and Hale (1999), I will also assume that the highest projection of N is KP (‘K’ for case features) and that this case shell on top of DP is universal (Neeleman and Weerman, 1999). Thus, I adopt the following internal structure (Figure 1.) for a personal pronoun in this paper. I also assume that demonstratives are under SpecDP. Note that N_{Π} is the category that bears the feature that encodes the input set of all the potential referents of a personal pronoun(see Section 3.1 for details).

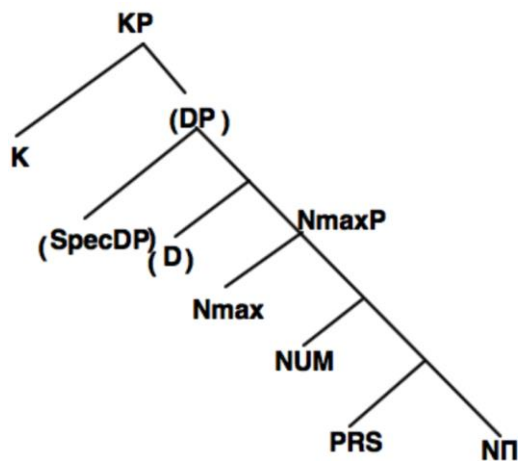

Figure 1. Internal structure of a personal pronoun

What's missing from Figure 1. is the position of gender features. I simply assume that gender is a feature of N and is situated under NUM, following Ritter (1993).

3. An impoverishment based derivation of the typology of polite addressee pronouns

Section 3.1 and Section 3.2 first present and motivate background assumptions of how polite addressee pronouns are morphologically presented in this paper, namely the features that make up these pronouns. Then I will describe how these features interact under the regulation of impoverishment rules to generate the typology of polite addressee pronouns.

3.1 Setting the stage: phi features and other traditional features in personal pronouns

This paper will represent phi features in the syntax and morphology as privative features for expository purposes and remain agnostic as to how they should be mapped between specific modules¹¹.

¹¹ When it comes to the representation of phi features in the grammar, there is a tension between representing phi features in a binary system and a privative system. Some scholars maintain that while certain phi features are privative, others are binary. For example, Nevins (2011) argues that Number features should be represented as privative and person features should be binary. The existence of such a tension arises as a result of the assumption that there is an isomorphic relationship between different modules of the grammar so that, for example, if phi features are represented in the semantics as binary features then they must be automatically binary in the morphology or the syntax as well. I agree with the insight from Preminger (2017) that non-isomorphic mappings between different modules of the grammar are the norm. Specifically, what this means for this paper is that in the syntax and morphology, phi features might be represented as privative, but in the semantics, it could be presented as binary. In fact, this idea could be fleshed out in some other form, for example, in Nevins (2011), it is suggested that there could be some redundancy rules that perform the 'transduction' between privative features (eg. plural) to binary features (eg. \pm singular) across different modules.

(1) Number redundancy rule at spell-out
 [plural] → [-singular]
 [] → [+singular]

In work like Harley and Ritter (2002), a 3rd person pronoun does not have a feature specification due to the popular view that 3rd person does not have a feature structure (e.g. Kayne, 2000). This paper, however, adopts the view that 3rd person does have a feature structure according to the feature system developed in Ackema and Neeleman (2018) (also cf. eg. Nevins, 2007). More importantly, based on the fact that politeness related impoverishment rules in this paper extends the research from Ackema and Neeleman (2018), I specifically adopt their model of privative person and number feature system. The details are as follows.

In Ackema and Neeleman’s system, two private person features, namely DIST and PROX, derive the inventory of all possible persons. Traditional systems use either binary features like [\pm participant], [\pm author] and [\pm addressee] (Halle, 1997) or privative features SPEAKER and ADDRESSEE (Harley and Ritter, 2002) to derive the inventory of persons. These features are predicates that pick out a subset of referents from an unstructured set of individuals. Different from traditional person features, DIST and PROX are functions that operate on a nested/structured set of persons (cf. Harbour, 2011) and, instead of giving sets of referents as output, these functions either select (DIST) the outmost circle of the nested set of persons or discard (PROX) it, keeping the remaining circle(s) as the output. Specifically, their system should work like the following (Figure 2. and its explanatory legends):

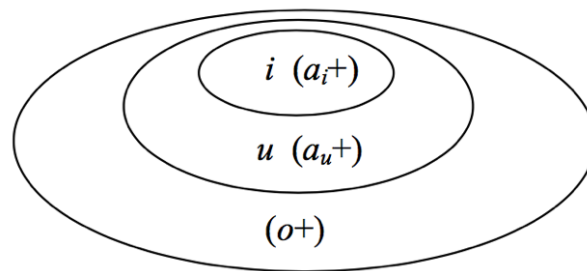

Figure 2: nested organization of the person space input in Ackema and Neeleman (2018)

i: the speaker (obligatory member of Set_i)

ai: associates of the speaker

u: the addressee (obligatory member if Set_u)

au: associates of the addressee

o: others

Set_{i+u+o}: initial input set, representing all potential referents in a given context, which has at least two members: **i** and **u**.

Additionally, different from traditional person systems, PROX and DIST can be applied multiple times, as long as the input domain to which they apply is a nested structure. The input set S_{i+u+o} is encoded by a feature Π in node N_Π . All pronouns are assumed to project from this node. Person features PROX and DIST are contained under the person node PRS which operate on set S_{i+u+o} delivered by Π . As a result, the person system for singular

pronouns can be derived as follows:

(12) Deriving 1st person singular pronoun

a. Applying PROX to S_{i+u+o} obtains S_{i+u} ;

b. Applying PROX to S_{i+u} obtains S_i , a set representing 1st person singular pronoun

(13) Deriving 2nd person singular pronoun

a. Applying PROX to S_{i+u+o} obtains S_{i+u} ;

b. Applying DIST to S_{i+u} obtains S_u , a set representing 2nd person singular pronoun

(14) Deriving 3rd person singular person

Applying DIST to S_{i+u+o} obtains S_o , a set representing 3rd person singular pronoun

It is impossible to apply PROX after DIST, because once DIST has been applied, the output is no longer a nested structure. This restriction on the ordering of DIST and PROX is reflected in the syntax. As noted before, both PROX and DIST are contained under the PRS node.

So far, we have the structure for singular persons:

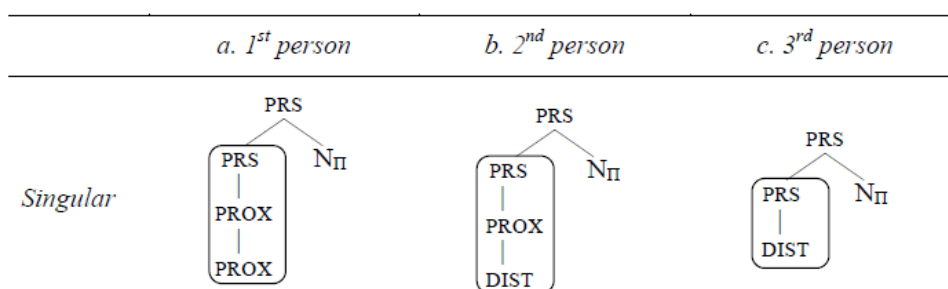

Table 1: derivation of singular personal pronouns in Ackema and Neeleman (2018)

Number information is encoded under NMB node, which is merged after PRS. I follow Ackema and Neeleman (2018) and represent singular number value as the absence of PL feature, and I represent other number values (e.g. dual and paucal) simply as privative features DUAL and PAUCAL. My analysis does not hinge upon the exact internal composition of potentially complex numbers like dual and paucal. See ft.14 and Conclusion for a potential and partial solution related to DUAL and PAUCAL number in Fijian polite addressee pronouns.

The reason that NMB is merged after PRS is because number information is assumed to be interpreted after person information (Ackema and Neeleman, 2018). Specifically, if number features operate on the input set S_{i+u+o} first, then the output is necessarily plural because there are at least two obligatory members: *i* and *u*. Later operations by person features might result in this output set having a singular member. Therefore, if person features are applied after number features, person features will potentially contradict the result of the application of number features. So, to avoid the application of number features trivially, the number node

NUM is placed above the person node PRS in the syntax due to the principle of semantic compositionality. Thus, plural personal pronouns are derived as follows:

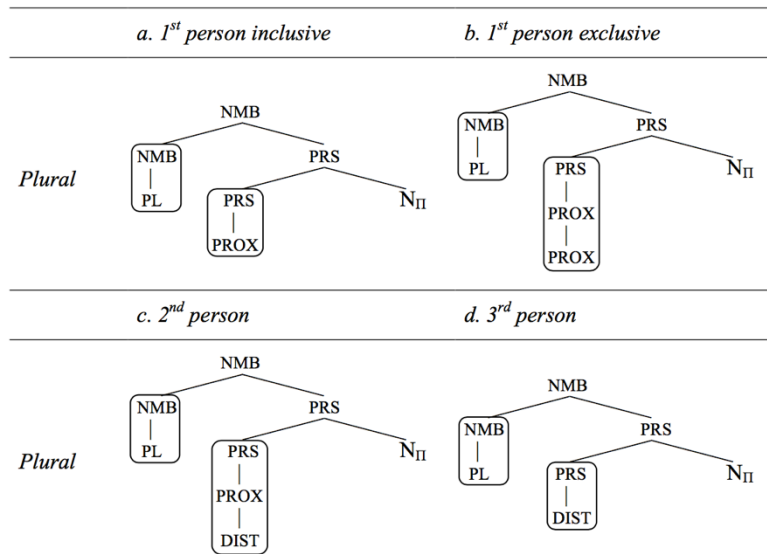

Table 2: derivation of plural personal pronouns in Ackema and Neeleman (2018)

Neuter gender value (as in Modern Standard German) is specified as 0 (lacking a gender feature specification); common gender value (as in Dutch) that is shared by both masculine and feminine gendered nouns) is represented as GENDER; masculine gender value (as in Italian) is represented as GENDER; feminine gender value (as in Italian) is specified as [Gender [FEM]]. The following is a summary of the representation of gender systems:

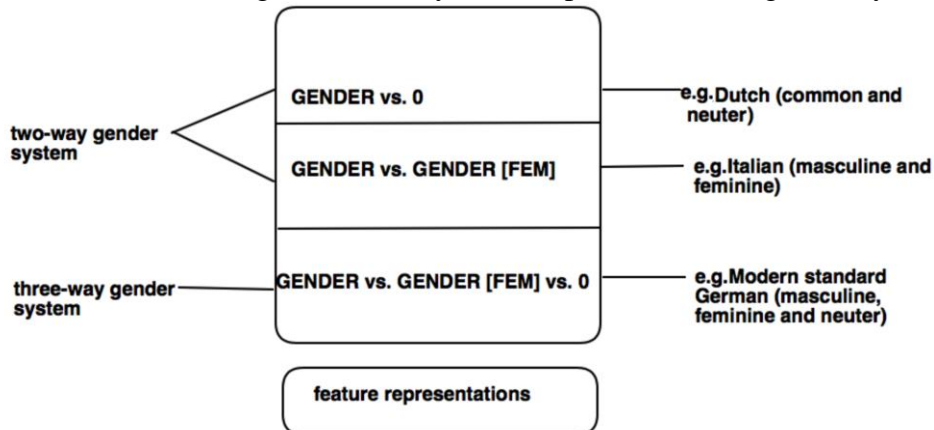

Table 3. sample representation of gender systems

I assume as a working hypothesis that demonstrative features are under SpecDP.

As to the specific position of REFL, I assume that it is located at the edge of DP/N^{maxP}. On the one hand, REFL bears on the inherent semantics of a pronoun like *himself* or *myself*, therefore it looks like that REFL should be a DP/N^{maxP}-internal feature by intuition. On the other hand, reflexive pronouns in object position require an antecedent. This anaphoric nature of reflexive pronouns suggests that REFL also links to the outside environment that a reflexive pronoun is in. This seemingly paradoxical situation could be potentially dealt with by assuming that REFL sits on the edge of the DP/N^{maxP} structure of a pronoun.

b. 2nd ('usually')sg polite kom -w-**os**
 2nd. respect marker (Lee,1975:105-107)

Compared with languages that have a dedicated polite 2nd person pronoun, Kosraean potentially spells out HON on a separate morpheme, whereas languages with dedicated polite 2nd person pronouns spell out HON as part of the feature bundle for the whole pronoun. Note that a third type, where HON and a subset of phi feature are spelt out as a feature bundle, is also attested. For example, in Japanese:

(16) anata-gata
 you-PL.HON
 'you all (respectful)' (Ackema and Neeleman, 2018)

On the other hand, the opposite value of HON (ie, -hon¹³) is also attested. For example, in Mandarin Chinese, the first person inclusive *zán* in (18) encodes a familiar tone towards the addressee, as opposed to the neutral first person (exclusive) plural pronoun in (17). However, as the discussions on familiar addressee and first person pronoun are beyond the scope of this paper, I do not discuss this point further.

(17) wǒ-men shénme shíhòu qù jiànshēngfáng?
 I-PL.(EXCL) what time go gym
 'When do we go to the gym?' (Neutral address)

(18) zán-men shénme shíhòu qù jiànshēngfáng?
 I-PL.INCL what time go gym
 'When do we go to the gym?' (Encodes Familiarity towards the addressee)

As Ackema and Neeleman (2018) have pointed out, HON is assumed to be limited to second person pronouns. In this sense, HON is not like other phi features because it is dependent on other orthogonal features, namely features for second person. This restriction should be reflected in the syntax. Exactly how this is structurally represented will be clear in Section 3.3. Note that this is a non-trivial point because this assumption puts HON feature very *below* the DP/N^{max}P level, which would turn out to be crucial to the analysis of this paper.

Ackema and Neeleman (2018) define HON as (19a-c). For the purpose for this paper, I will temporarily adopt their definition. I will also add (19d) as part of its definition, the reason of which will be clear in Section 4. I will point out in the conclusion that a revised definition of HON might be required when we account for FAM (for 'familiar') and multiple-politeness addressee pronominal systems.

¹³ This paper is not about choosing between bivalent or monovalent feature systems, but since I have used monovalent feature throughout, we have a choice here to either treat it as -hon or as a separate monovalent feature, eg. FAM (for 'familiar'). HUM (for 'humble'). What helps us to choose between these two options depend on how the typology fares out. For example, it is suggested that in Brazilian Portuguese we might need a FAM feature rather than a HON feature (Andrew Nevins p.c.). And also to that effect one might take into consideration first persons that permits humble forms but not honorific forms (e.g. Mandarin Chinese). At this stage, I'm not sure what exactly this type of data would tell us. This is to be explored further.

(19) **Definition of HON** (revised version)

a. HON selects [PROX DIST]

(Only second person pronouns have a polite form.)

b. HON (S)=S

(HON delivers the same set of referents as it receives.)

c. If $x \in \text{HON}(S) \wedge x = u$, then HONOURABLE(x)

(HON adds the information that relevant members in the input set are honourable.)

d. HON needs to be licensed in the syntax.

According to (19c), *u* (for ‘addressee’) referents but not *o* (for ‘others’) are marked as honourable, this follows from an observation from Daniel Harbour (Daniel Harbour p.c. Perter Ackema and Ad Neeleman): ‘If one addresses a friend and uses a second person plural pronoun to refer to that friend and his honourable but absent parents, the familiar form (eg. *jullie* in Dutch, plural verbal agreement) will be used, without this implying any familiarity towards the parents. However, if one addresses the parents, using a second person plural pronoun to refer to them and their son, then the polite form (eg. *u* in Dutch, always singular verbal agreement) must be used if honorificity is intended, without this implying any formality towards the son.’ I believe this observation could be used as a heuristic for detecting addressee pronouns containing a HON feature because any languages that have a familiar-polite dichotomy in the addressee pronominal system will show the above-mentioned effect described by Daniel Harbour, which I call ‘the Parents-Son test’.

3.3 An impoverishment account of the typology of polite addressee pronouns

Having introduced the features that make up polite addressee pronouns, this section present the morphological impoverishment rules that derive the typology (8 patterns in total) of polite addressee pronouns. I will assume a Distributed Morphology model for my analysis. As we’ll soon see below, both LF and PF impoverishment rules need to apply in order to derive **Patterns 3, 4, 5**. However, impoverishment rules that apply on the LF side in all of the syncretic patterns (**Patterns 2, 3, 4, 5, 6, 7**) are the focus of this paper. First, I introduce some background information on LF impoverishment.

The term ‘Impoverishment’ normally refers to post-syntactic deletion rules on the PF side before phonological interpretation. The term ‘LF impoverishment’ is less well known than PF impoverishment. However, the notion of LF impoverishment, namely deleting features post-syntactically at LF before semantic interpretation, has already started to emerge in generative linguistics since at least Grimshaw (1997).

(20) I study linguistics, and you **do** ~~study linguistics~~ too.

(21) I **do** not think it is wise to haste your decision.

A support-verb like *do* is normally seen in elliptical sentences (20) and also in negation (21). Grimshaw’s (1997) idea is that *do* has semantic content, but it’s very minimal. A do-support *do*, however, does not have semantic content at all, which equals suggesting that there is LF

impoverishment of the content of *do* in the specific environment of do-support construction. Among the semantic literature, Heim (2008) discusses a type of phenomenon that could be potentially analysed as a case of LF impoverishment: phi features on bound pronouns. The idea is that in a sentence like *Only I did my work* (Heim, 2008), the 1st person feature on bound pronoun *my* is not interpreted when this sentence means ‘x is such that x is the only person that did x’s homework and x refers to the speaker’ (see also Rullman 2003, 2004 on number features on bound pronouns). This non-interpretation of 1st person feature on the bound pronoun *my* could be potentially seen as undergoing deletion of 1st person (or [+author, +participant]) feature.

Recent literature has more explicitly laid out the notion of LF impoverishment. Nevins (2008) explicitly identifies LF impoverishment as a parallel deletion process compared to the PF impoverishment in a Y-model grammar. He termed LF impoverishment ‘deprivation’, distinguishing it from our normal conception of ‘impoverishment’ processes in general, which only happen at PF. He gave an example from the language Santali, in which the first person inclusive is used as second person singular with a threatening pragmatic effect towards the addressee. The analysis implied in Nevins (2008) is that an LF impoverishment operation change the feature for 1st person and non-singular number into 2nd person and singular number (much like the Muna pattern that will be introduced in this section, albeit the pragmatic effects are quite different between Santali and Muna). Another potential LF impoverishment mentioned in passing by Nevins (2008) are instances of generic 2nd person pronouns, which he suggested could be considered as LF impoverishment of [-author, +participant] under binding by a generic operator. I implement LF impoverishment as a major part of my morphological theory of pronouns in this paper.

First, I recapitulate the morphological derivations of the four typological patterns in Ackema and Neeleman (2018):

Pattern 1: no Impoverishment in Dutch¹⁴

Dutch *u* is a dedicated polite singular/plural addressee pronoun, which spells out the feature bundles including HON, as illustrated by Table.4. The dedicated spell-out rule is as in (22b). As mentioned in the previous section, HON is dependent on features that derives second person, namely the structure that contains the person feature configuration PRS-PROX-DIST.

(22) Dutch: dedicated polite addressee plural and singular pronouns

a. Syntactic input: {D PROX DIST HON (PL)}

¹⁴ There might be impoverishment for number in Dutch (Ad Neeleman p.c.), which is either going to be at LF or PF, or both. The Dutch polite pronoun is a number neutral form just like English *you*. It triggers singular agreement but it can clearly have a plural interpretation. For example, it can bind reciprocals. Besides, one can address a group using the polite pronoun *u*. There is two way of dealing with this complication. One is to say that there is never been a plural feature; the other is to posit a deletion process for the plural feature at PF. I don’t know whether there is evidence one way or the other. Ackema and Neeleman (2018) report that they didn’t have evidence for impoverishment of number in Dutch.

b. {D PROX DIST HON} → /u/¹⁵

(Vocabulary Insertion¹⁶ rule at PF)

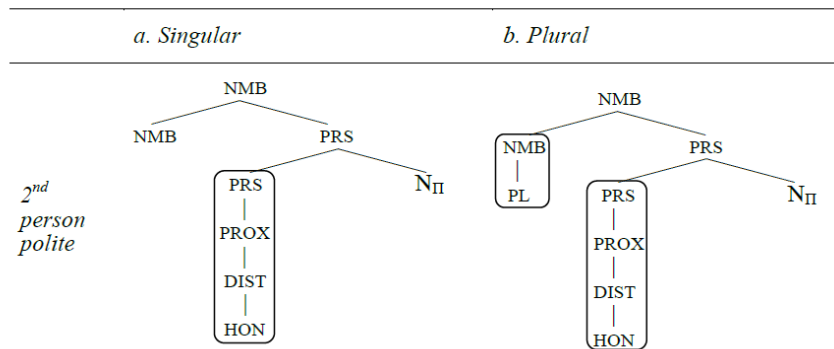

Table 4. Derivation of dedicated polite addressee pronouns in Dutch (Ackema and Neeleman, 2018)

On the PF side, the spell-out rule for polite singular addressee pronoun is the same as the spell-out rule for polite plural addressee pronouns. Note that in (22b), the left-hand side of the spell-out rule does not mention a PL feature, this is because the left-hand side of a spell-out rule only expresses part of the syntactic input of a plural polite addressee pronoun and is not a direct reflection of what features are in the syntax of a plural polite addressee pronoun. Rather the features of the spell-out rules specify what features the vocabulary item /u/ realizes. The criterion for inserting a vocabulary item by a spell-out rule is called the Subset Principle in Distributed Morphology (Halle and Marantz, 1993). The form for 2nd polite addressee pronouns only realizes a subset of the feature set that is encoded by the syntax of 2nd person polite plural pronoun {D PROX DIST HON PL}. When different forms are competing for the vocabulary insertion/spelling out process, a form is used if it expresses the Maximal subset of features of that terminal node. This is called the (Maximal) Subset Principle, which is an instance of the Elsewhere Condition from Kiparsky (1973) (see also Nevins (2016) and Ackema and Neeleman¹⁷ (2018) for their interpretations of the Maximal Subset Principle). In this case, since there is no other form that expresses more features from

¹⁵ Following the concern for readability in Ackema and Neeleman (2018), the double slashes in the formulation of impoverishment rules in this paper simply mean that the form is an overt form that is spelt out, rather than a phonetic representation of the spelt-out form.

¹⁶ The term ‘Spell-out’ is used in Ackema and Neeleman (2018) rather than ‘Vocabulary Insertion’. ‘Spell-out rule’ and ‘Vocabulary Insertion rule’ refer to the same thing.

¹⁷ In Ackema and Neeleman (2018) the Maximal Subset Principle is interpreted as the ‘Maximal Encoding Principle’ that applies both at PF and LF.

(2) Maximal Encoding

A mapping $R \rightarrow R^*$ is licit only if R^* is the maximal expression of R at the relevant level of representation. R^* expresses R maximally if there is no alternative R' that encodes more properties of R or encodes these properties in more locations. Ackema and Neeleman (2018)

{D PROX DIST HON PL} than /u/, /u/ trivially wins the competition and is inserted as the spell-out form for the 2nd person polite plural pronoun.

Pattern 2: LF impoverishment in **French**

Unlike Dutch, which has a dedicated spell-out rule for the addressee polite pronoun *u*, French recruits existing pronouns from its pronominal paradigm. This is a case of syncretism. As can be seen from Table 5., 2nd person plural form can be recruited as 2nd person singular polite pronoun. Number information is changed from plural value to singular value. As mentioned previously, if we assume that singular is the absence of PL, then PL must be deleted before the interpretation of the singular polite addressee pronoun on the LF. This is formulated as the impoverishment rule in (23b). Here, the French familiar form *vous* is used to spell out {D PROX DIST HON} because there is no other form that expresses a larger subset of {D PROX DIST HON PL}.

	singular	plural
1st	je	nous
2nd familiar	tu	vous
2nd polite	vous	vous
3rd	on/il(MASC)/elle(FEM)	ills(MASC)/elles(FEM)

Table 5. French personal pronouns (nominative)

(23) French: (source form) 2nd pl → (target form) 2nd polite sg

a. Syntactic input: {D PROX DIST HON PL}

b. PL → ∅ / [__ HON]

(Impoverishment rule at LF)

c. {D PROX DIST PL} → /vous/

(Vocabulary Insertion rule at PF)

Pattern 3: PF and LF impoverishment in **Muna**

Among the 71 languages in WALS that have a polite distinction in addressee pronouns, about one third (20 languages, eg. French) use 2nd plural pronoun as a polite singular addressee pronoun. The pattern exhibited by the language Muna, on the other hand, is much rarer. By far, there are only two other languages among the 71 languages in WALS that are documented to use 1st inclusive pronoun as polite singular addressee pronoun: Ainu and Marathi. Ainu is an endangered language with very few native speakers. Besides, for cultural reasons, fieldwork for generative linguistic research is very difficult (Sato Tomomi p.c.). Also, data from Marathi is incomplete due to lack of immediately available native speakers. I will therefore limit my discussion to Muna.

In Muna, a single verb inflected for person and number (and realis mood) can function as a clause (24a). If a free pronoun is present, then this indicates emphasis on the pronoun (24b).

(24)

- a. **a-**leni
1SG. REALIS-swim
'I am swimming.'
- b. inodi **a-**leni
I 1SG.REALIS-swim

The bolded morpheme *a-* agrees with the free pronoun subject. It is called a subject marker. Verbs in Muna thus have subject inflection. The following chart from Van den Berg (1989:51) is an illustration of subject inflection of the verb *go*. The second column is a list of corresponding free pronouns.

Person	pronoun	verb	gloss
sg 1	inodi	a-kala	'I go.'
2	ihintu	o-kala	'You go.'
2 polite	intaidi	to-kala	'You (polite) go.'
3	anoa	no-kala	'He/she/it goes'
du 1 inclusive	intaidi	do-kala	'We (2incl) go'
pl 1 inclusive	intaidi-imu	do-kala-amu	'We (>2 incl) go.'
1 exclusive	insaidi	ta-kala	'We (ex) go.'
2	ihintu-umu	o-kala-amu	'You (plural) go.'
2 polite	intaidi-imu	to-kala-amu	'You (polite plural) go.'
3	andoa	do-kala	'They go.'

Table 6. Free personal pronouns and subject inflection for the verb *go* in Muna

Table 6. shows that inclusive dual is used as polite singular addressee pronoun. Similar to French, on the LF, Muna also requires a rule that deletes the number feature for expressing dual number (25b). What is different is that on the PF, Muna requires an additional impoverishment rule than French, where the syntactic input {D PROX DIST DU¹⁸ HON} loses the DIST feature so that 1st inclusive person form could surface.

(25) Muna (Van den Berg 1989): (source form) 1st incl → (target form) 2nd sg polite

a. Syntactic input: {D PROX DIST HON DU}

b. DU → ∅ / [__ HON] (Impoverishment rule at LF)

¹⁸ As I have stated previously, DU is not a feature but a shorthand for multiple features. Details will be clear when I discuss Fijian data later.

c. DIST → ∅ / [__ PROX DU HON] (Impoverishment rule at PF)

d. {D PROX DU} → /intaidi/ (Vocabulary Insertion rule at PF)

Pattern 4: PF and LF impoverishment in **German**

The last pattern reported in Ackema and Neeleman (2018) is German, where 3rd person plural/singular is used as polite addressee pronouns.

	singular	plural
1st	ich	wir
2nd familiar	du	ihr
2nd polite	sie _{pl}	sie _{pl}
3rd	er/sie _{sg} ¹⁹ /es	sie _{pl}

Table 7. Modern Standard German personal pronouns (nominative)

	singular	plural
1st	ich	wir
2nd familiar	du	ihr
2nd polite	er/ sie _{sg}	sie _{pl}
3rd	er/ sie _{sg} /es	sie _{pl}

Table 8. Historical German personal pronouns (nominative)

(26) Modern Standard German: (source form) 3rd pl → (target form) 2nd sg polite

a. Syntactic input: {D PROX DIST HON PL}

b. PL → ∅ / [__ HON] (Impoverishment rule at LF)

c. PROX → ∅ / [__ DIST HON PL] (Impoverishment rule at PF)

¹⁹ Note that the third person singular feminine pronoun *sie*_{sg} has singular agreement on the verb. Polite 2nd pronoun patterns with 3rd plural pronoun in that they both trigger plural agreement on the verb. In the illustration of data in this section, when two forms are treated as syncretic, it is implied that their verbal agreement is also the same unless otherwise stated.

I assume that syntactic verbal agreement patterns are the most reliable evidence for the existence of corresponding features in a pronoun because semantic verbal agreement rarely happens (see Wechsler, 2011). An important part of the entire PhD project is to collect cross-linguistic data from native speakers on the verbal agreement patterns of (subject) second person pronouns.

d. {D DIST PL } → /sie/

(Vocabulary Insertion rule at PF)

Historical German²⁰ could also use third person singular pronouns as singular polite addressee pronouns. If so, Historical German would adopt the derivation for Modern Standard German minus the LF impoverishment of PL since the syntactic input does not contain a PL.

(27) Historical German: (source form) 3rd sg → (target form) 2nd sg polite

a. Syntactic input: {D PROX DIST HON }

b. PROX → ∅ / [__ DIST HON]

(Impoverishment rule at PF)

c. {D DIST } → /er/sie/

(Vocabulary Insertion rule at PF)

The following 4 patterns are additional typology that are not covered by Ackema and Neeleman (2018). For Fijian and Marathi, data on agreement pattern for the PhD project is still in pursuit due to lack of immediately available native speakers. For this reason, I will directly report the descriptions from references from WALS as to how polite addressee pronouns are used in Fijian and Marathi.

Pattern 5: PF and LF impoverishment in **Italian**

Table 9. shows that Italian singular 3rd feminine pronoun is used as polite singular addressee pronoun. On the LF (28b), FEM is deleted before semantic interpretation because the addressee could be both masculine and feminine when *lei* is used (Ester Vespasiani, Giulio Dulcinati and Caterina Paolazzi p.c.). On the PF (28c), the syntactic input structure for second person {D PROX DIST FEM HON } loses the PROX feature so that third person form is spelt out.

	singular	plural
1st	io	noi

²⁰ The fact the second person plural could be used as polite addressee pronoun in Historical German is not reported in Ackema and Neeleman (2018). For completeness's sake, I also explain how this pattern is derived as (3) but not repeat it in the content part of the paper since it's the same pattern as French.

(3) Historical German (During the period from Old High German to early 19th century roughly (Simon, 2003).): (source form) 2nd pl → (target form) 2nd sg polite

a. Syntactic input: {D PROX DIST HON PL }

b. PL → ∅ / [__ HON]

(Impoverishment rule at LF)

c. {D PROX DIST PL } → /ihr/

(Vocabulary Insertion rule at PF)

2nd familiar	tu	voi
2nd polite	lei	voi
3rd	lei (FEM)/lui(MASC)	loro

Table 9. Italian personal pronouns (nominative)

(28) Italian: (source from) 3rd sg fem → (target form) 2nd sg polite

a. Syntactic input: {D PROX DIST HON FEM}

b. FEM → ∅ / [__ HON] (Impoverishment rule at LF)

c. PROX → ∅ / [__ DIST HON FEM] (Impoverishment at PF)

d. {D DIST FEM} → /lei/ (Vocabulary Insertion rule at PF)

Pattern 6: Fijian LF impoverishment

The pattern in Fijian as described in WALS seems like that of French except that not only plural 2nd pronouns could be used as polite singular addressee pronouns, but also paucal and dual 2nd person pronouns could be used as singular polite addressee pronouns as well. Therefore, three (values of) number features could be the target of HON-triggered LF impoverishment rule like (29a).

	singular	dual	paucal	plural
1inclusive		(e)taru	tou	(e)ta
1exclusive	au~u	'eirau	'eitou	'eimami
2nd	o	(o)mudrau~(o)drau	(o)mudou~(o)dou	(o)munnu~(o)nuu
3rd	e	(e)rau	(e)ratou	(e)ra

Table 10. Fijian personal subject pronouns (Dixon 1998:54-55)

(29) Fijian: (source form) 2nd plural/paucal/dual → (target form) 2nd sg polite

a. Syntactic input: {D PROX DIST HON PL/PAUCAL/DU}

b. PL/PAUCAL/DU²¹ → ∅ / [__ HON] (Impoverishment rule at LF)

²¹ The LF rules for DU and PAUCAL impoverishment are actually an oversimplification here. DU and PAUCAL are assumed to be more complex number features than PL and could presumably be made of more than one sub-features. For example, in Ackema and Neeleman (2018), DU may consist of AUG (for 'Augmented') and MIN (for 'minimal'). In Harley and Ritter (2002), PAUCAL is made up of AUG, MIN and GROUP.

I assume that one HON feature triggers one impoverishment rule of one syntactic feature at a time. For pronouns of complex feature values like DU and PAUCAL, HON features could be stacked: HON-HON, or HON-HON-HON, which could trigger the deletion of two or three syntactic features. In fact, the stacking of HON features has its empirical basis. In Fijian, the three polite addressee pronouns in (4-6) may form a

- c. {D PROX DIST DU } → / (o)mudrau~(o)drau/
 or {D PROX DIST PAUCAL } → / (o)mudou~(o)dou/
 or {D PROX DIST PL } → / (o)munnu~(o)nuu/ (Vocabulary Insertion rule at PF)

Pattern 7: Hungarian LF impoverishment

(30) Hungarian: (source form) anaphoric reflexive²² pronoun → (target form) polite 2nd sg

- a. Syntactic input: {D PROX DIST HON REFL (PL)}
- b. REFL → ∅ / [__ HON] (Impoverishment rule at LF)
- c. PROX → ∅ / [__ DIST HON REFL (PL)] (Impoverishment at PF)
- d. {D REFL PL} → Önök
 or {D REFL} → Ön (Vocabulary Insertion rule at PF)

Pattern 8: Mandarin Chinese PF impoverishment of HON

	singular	plural
1 st person	wǒ	wǒ-men
1 st person familiar	zán	zán-men
2 nd person	nǐ	nǐ-men
2 nd person polite	nín	*nín-men
3 rd person	tā	tā-men

Table 11. Mandarin Chinese personal pronouns

The singular polite addressee pronoun is a dedicated one, which would have a dedicated spell-out rule (31b) like Dutch. However, the singular polite addressee pronoun can neither

hierarchy of politeness based on the different situations that they are used. The hierarchy could potentially correspond to how many HON features the source form of a polite addressee pronoun has.

- (4) When the paucal 2nd pronoun is used as a singular polite addressee pronoun, it is used to address brothers or sisters of opposite sex, elder siblings of the same sex.
- (5) When the dual 2nd pronoun is used as a singular polite addressee pronoun, it is used to address mother-in-laws and farther-in-laws.
- (6) When the plural 2nd pronoun is used as a singular polite addressee pronoun, it is used to address the village chief or generally old person who are respected. Dixon (1988)

²²Historically (roughly from 18th century to early 19th century), *dieselben* in German, literally translated as ‘the selves’ are also used as a polite pronoun for a certain period (Simon, 1997, 1998). However, Simon (2003) contends that *dieselben* is not a personal pronoun, but a ‘pronoun of identity’.

be used to address plural individuals²³ nor be pluralized by *-men* like first and third person pronouns, as the ungrammaticality of **nín-men/2nd.HON.PL* shows. Only neutral/familiar plural form *nǐ-men/2nd.SG.PL* can be spelt out. To account for this pattern, I assume that the HON feature is deleted at PF in the presence of PL feature by a rule like (32b), which also accounts for the ungrammaticality of polite addressee plural form **nín-men/2nd.SG.HON.PL*.

(31) Mandarin dedicated singular polite addressee pronoun

a. Syntactic input: {D PROX DIST HON}

b. {D PROX DIST HON} → /nín/ (Vocabulary Insertion rule at PF)

(32) Derivation of Mandarin polite addressee plural pronoun

a. Syntactic input: {D PROX DIST HON} + {PL}

b. HON → ∅ /[_ PL] (PF impoverishment of HON)

c. {D PROX DIST PL} → /nǐ-men/ (Vocabulary Insertion rule at PF)

4. Case cannot mark politeness in polite addressee pronouns: a phase analysis

The structural parallelism between nominals (e.g. DPs) and clauses (e.g. CPs) have long been discussed in the literature, see e.g. Chomsky (1970), Abney (1987) and Szabolsci (1994) for some of the earliest work. The structural commonality between clauses and nominals that this paper is particularly concerned with is the notion of *Phase* developed by Chomsky (2000, 2001), who argues that there are two Phases in clauses: CP and vP. This idea has now become the standard assumption about the structure of clauses. The notion of Phase indicates that syntactic operations are relativized to locality constraints. Chomsky (2000) claims that syntactic operations like selectional requirements and movements can access the head and the edge of a phase, which is phrased as the Phase Impenetrability Condition:

(33) Chomsky's (2000:108) **Phase Impenetrability Condition (PIC)**

In phase α with head H, the domain of H is not accessible to operations outside α , but only H and its edge.

In a sense, if α is a phase, then the phase domain (the complement of H) becomes 'opaque' to operations outside phase α . Another condition related to PIC, which we'll also adopt here, is the original proposal in Chomsky (2000) and more recently argued for in Bošković (2016)²⁴: the unit of spell-out is the phase itself, not the complement of a phase. This assumption seems to fit well with the fact that a pronoun like the English object pronoun *him* is spelt out together with its case feature, which is valued on D, the head of the DP phase. If what is spelt out is the complement of D head, then there will not surface a pronoun that has case. This is

²³ This would be a case of suppletion.

²⁴ There is a difference between Chomsky (2000) and Bošković (2016). Bošković (2016) limits the PIC to non-phasal head. Specifically, the edge of a Phase is accessible only to non-phasal heads and the next phasal head up would make this Phase completely accessible.

because, as the syntax builds a pronoun from bottom to top, as soon as the head D is merged, the spell-out of its complement is immediately triggered according to the standard Minimalist view. Any feature on D (eg. case feature) will not have anything to do with the phonological form of a pronoun. Therefore, I'm inclined to adopt the view that phases rather than phasal complements are the units of spell-out. Consequently, I will assume that what triggers spell-out of the DP/N^{max}P phase is the head of KP, after the last part to complete a phase is merged, eg. SpecDP²⁵. Moreover, the typology of polite addressee pronouns provides independent evidence for the claim that DP rather than the complement of D is spelt out. Helmbrecht's (2003) shows that demonstratives²⁶ in Sinhalese could be used as polite addressee pronouns, which means that demonstrative features could mark politeness too. It is very informative to find a language where features in D could mark politeness, because this indicates that D and HON are within the same spell-out domain due to the syntactic requirement of HON (34), which will be introduced immediately as follows. Therefore, evidence provided by Sinhalese also fits naturally in the phasal spell-out view in Chomsky (2000) and Bošković (2016).

The solution as to why case cannot mark politeness is based on the notion of phases introduced here. Particularly, I assume that, in the syntax, HON can only interact with phi features and other DP/N^{max}P internal features. That this interaction is opaque to elements outside DP/N^{max}P phase is a direct result of PIC and how a syntactic structure is spelt out. Once an DP/N^{max}P is triggered by the head D/ N^{max} to be spelt out, the whole syntactic unit of DP/ N^{max}P is deleted in the syntax. Therefore, HON cannot interact further with features outside of DP/ N^{max}P as a consequence of this discard operation that wipes out HON altogether in the syntax. To be more concrete, I relativize this 'interaction' between HON and another syntactic feature as a syntactic licensing condition (34).

(34) **Syntactic Requirement of HON**

HON requires a feature in the syntax (in languages that do not have a dedicated spell-out rule for polite addressee pronouns)

(Or HON requires a syntactic feature for it to be licensed).

(34) as a requirement of a 'needy'²⁷ HON feature is somewhat unusual as a syntactic requirement in generative linguistics as we rarely see any constraints saying that a certain feature 'needs' the presence of another orthogonal feature in the syntax. However, the syntactic requirement of HON fits naturally into a two-step model of Agree if the licensing of HON is a manifestation of just the first step of such an agreement model, because we can

²⁵ It should predict another typological pattern of polite addressee pronouns if possessive features are in SpecDP. As features in SpecDP would be accessible to HON too, HON would also be licensed due to (34) by a possessive feature. The result would be that there is a language X, in which possessive pronouns could be used as polite addressee pronouns.

²⁶ This paper does not discuss this pattern here due to lack of fieldwork data but aims to address it in the Dissertation.

²⁷ The term 'needy' is given a proper theoretical status in the Search and Copy theory of Vowel Harmony by Nevins (2010). He argues that Vowel Harmony is needy-vowel-centric, namely that Vowel Harmony is a procedure created by a needy vowel searching for features required by the vowel, like laxness and roundness. The search domain of a needy vowel is also constrained by locality conditions. This local search is relativized by parameters like contrastiveness and markedness. For example, some languages relativize the Search procedure solely to vowels that are marked for the harmonic feature. Note that the phenomenon of needy vowels is about a feature needing a feature value, not a feature needing another orthogonal feature like HON does.

interpret (34) as HON searching for a licensing feature in the syntax within the DP/N^{max}P phase boundary. As a general illustration, in a two-step agreement model, the first step of agreement is to establish a relation between the probe and the goal; the second step is to realize the features that belong to this relation, i.e. the morphological realization of the agreement. For example, Chung (1998) first proposed a two-step model of agreement. Arregi and Nevins (2012) call the first step ‘Agree-Link’ and the second step ‘Agree-Copy’ (which is post-syntactic²⁸). In Batt and Walkow (2013), the process of agreement is broken down into ‘matching’ and ‘valuation’. In Ackema and Neeleman (2018), the first step of agreement is the syntactic association of the target and the controller and is subject to locality conditions; the second step consists of several LF processes that renders the syntactic structure interpretable.

(34) needs to be checked at some point in the derivation of a polite addressee pronoun. Apparently, this derivation will be blocked by the phasal status of DP/ N^{max}P. Since case features are located outside DP/N^{max}P phase, they cannot satisfy the syntactic requirement of HON (34). From a standard minimalist point of view, this would mean that the derivation would have crashed in the syntax already. Thus, a case marked polite addressee pronoun will not surface. To back up this hypothesis, I will subsequently present arguments from the literature on the phasal status of DP/N^{max}P.

4.1 DP/N^{max}P is a phase

This paper adopts the main assumption from Bošković (2013) that DP is a phase in DP-languages and N^{max}P is a phase in N^{max}P-languages. The parameter between DP languages and N^{max}P²⁹ languages is whether (definite) articles are present in the language or not. I will introduce two syntactic diagnostics for distinguishing the two types of languages. See for details on the syntactic and semantic motivations for the DP/N^{max}P parameter in Bošković (2008) and Bošković and Gajewski (2011).

Serbo-Croatian is an article-less language, where the noun *kamen*/stone does not appear to have an article, unlike the English gloss, which contains an article for *stone*.

(35) Kamen je razbio prozor

stone is broken window

‘The stone broke the window.’

Bošković (2013)

Based on two syntactic diagnostics: left-branch extraction (36) and adjunction extraction out of DP/N^{max}P (39), Bošković (2013) distinguish languages with articles like Serbo-Croatian and languages without articles like English. I briefly introduce these two diagnostic generalizations, which have been shown to be true of many other languages as well (see for details: Uriagereka, 1988; Corver, 1992; Barker 1996; Bošković, 2005; Franks 2007; Bošković, 2013).

²⁸ In Willer-Gold et al. (2016), the second step Agree-Copy can be syntactic or post-syntactic.

²⁹ I replaced the term ‘NP’ in Bošković (2013) with N^{max}P, because what he meant in that paper by ‘NP’ just is the complement of D. As I have stated in ft. 3, N^{max}P is a label for the complement of D.

(36) Only languages without articles³⁰ allow left-branch extraction³¹ as in (38) (Uriagereka, 1988; Corver, 1992; Bošković, 2005):

(37) English

*Expensive_i he saw [_{t_i} cars]

(38) Serbo-Croatian

Skupa_i je vidio [_{t_i} kola]
expensive is seen car

(Bošković, 2013)

(39) Only languages without articles may allow adjunct extraction out of DP/ N^{max}P as in (41):

(40) English

*From which city_i did Peter meet [girls _{t_i}]?

(41) Serbo-Croatian

Iz kojeg grada_i je Pater sreo [djevojke _{t_i}]
from which city is Petko met girls

(Bošković, 2013)

Left-branch extraction (as in 38)³² is also used as a tool to demonstrate the phasehood of DP. If DP is a phase boundary, then a constituent cannot move out of this boundary. Moreover, there will be anti-locality effects if an otherwise expected movement within that boundary is too short. As a simple illustration, the concept of phase dictates that movement must be short/within a certain boundary; anti-locality requires that movement must not be too short—movement must cross a whole phrase (Bošković, 2005). This paradoxical effect predicts the patterns in (42) in English, which explains why left-branch extraction of AP is not possible in English:

(42) English

a. ***[DP AP]_i** [_{D'} D [_{NP} _{t_i} [_{NP} ...

b. * AP_i [**DP** [_{D'} D [_{NP} _{t_i} [_{NP}...

(Bošković, 2013)

Bošković (2005) argues that, taking the standard claim that AP is NP-adjoined, AP cannot move out of DP (as in 42b) due to the hypothesis that DP is a phase and the PIC condition; AP also cannot move to SpecDP (as in 42a) due to anti-locality effects, i.e. movement of this AP should cross at least one full phrasal boundary (see motivations for the anti-locality hypothesis in Bošković 1994, 1997; Saito and Murasugi, 1999; Ishii, 1999, Abels, 2003; Grohmann, 2003; Grohmann and Haegeman, 2003; Ticio, 2003, Boeckx, 2005; Jeong, 2006).

³⁰ Note that in the generalizations (36) and (39), ‘articles’ means ‘definite articles’ (Bošković, 2013: ft 3). According to Bošković, although Serbo-Croatian lack definite articles, it does have elements that are like English ‘that’, ‘some’ and ‘John’s’, which look like definite articles but not entirely, because these elements in Serbo-Croatian have syntactic and morphological properties of adjectives (Zlatić, 1997; Bošković, 2008).

³¹ Left-branch extraction was proposed by Ross (1967/1986:127), which means movement out of an NP to the leftmost of this NP.

³² (39) is also used as a test for phasehood in Bošković (2013).

Therefore, left branch extraction of AP is banned in English due to the combined efforts of PIC and anti-locality. Unlike English, Serbo-Croatian (43) permits left branch extraction of AP, which is expected because Serbo-Croatian lacks a DP layer.

- (43) Lijepe_i je vivio [t_i kuće]
 beautiful is seen houses
 ‘Beautiful houses, he saw.’ Bošković (2005)

By far we have briefly seen evidence that DP is a phase. The phasal status of N^{max}P is also argued for in Bošković (2013³³). Languages without articles would lack a DP layer and is thus assumed a N^{max}P language, in which case the N^{max}P rather than the DP is a phase according to Bošković (2013). This conclusion is supported by the fact that Serbo-Croatian disallows what looks like ‘deep’ left branch extraction from a noun complement.

We have seen that Serbo-Croatian (38, see also 43 below) allows a sort of ‘shallow’ left branch extraction where there is only one layer of NP in which the AP originates, since there is no DP layer to block this movement. However, Serbo-Croatian does not permit ‘deep’ left branch extraction as in (44b), where AP is extracted out of the nominal complement of another noun.

- (43) Pametene_i on ajieni t_i students
 smart_{ACC} he appreciates students_{ACC}

- (44) a. On cijeni [N_{max}P [N' [prijatelje [NP pametnih [NP studenata]]]]
 he appreciates friends_{ACC} smart_{GEN} students_{GEN}
 ‘He appreciates friends of smart students.’

- b. *Pametnih_i on cijeni [N_{max}P [N' [prijatelje [NP t_i [NP studenata]]]]
 smart_{GEN} he appreciates friends_{ACC} students_{GEN} (Bošković, 2013)

The blocking effect of the Serbo-Croatian (44b) N_{max}P dominating the NP from which the AP *pametnih*/smart_{GEN} originates is the same as that of the English (37) DP dominating the NP from which the AP originates. This structural parallelism leads Bošković to conclude that N^{max}P is also a phase in N^{max}P languages.

To be more specific, the ungrammaticality of (44b) is due to similar paradoxical effects (ie. PIC and violation of anti-locality) as that of the English pattern (38) on ‘shallow’ left branch extraction of AP. First, assuming N^{max}P in Serbo-Croatian is a phase and the step-wise requirement on movement in Chomsky (2000, 2001) (45), movement of the AP *pametnih*/smart_{GEN} must move to the specifier of N^{max}P first. However, this movement cannot happen because it is too short due to the anti-locality hypothesis, i.e. the path marked by * in Figure (3) is too short because it is only a segment of a phrase rather than the full length of a phrase.

- (45) If XP is a Phase, then movement out of XP must proceed via SpecXP.

³³ Bošković (2005) argued that N^{max}P is not a Phase. Bošković (2013) is an update on his earlier analysis of the phasehood of N^{max}P.

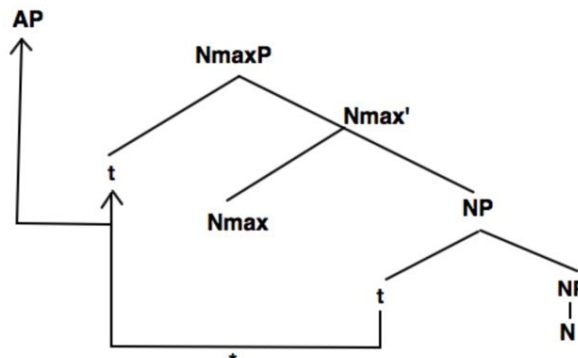

Figure 3. Ban on ‘deep’ left branch extraction³⁴ in Serbo-Croatian (Bošković, 2013)

Apart from the diagnostic of ‘deep’ left branch extraction, another piece of independent evidence supports the claim that $N^{\max}P$ is a phase in Serbo-Croatian. According to Abels (2003), the complement of a phase head cannot move out of this phase, this would predict that the complement of a $N^{\max}P$ cannot move, which is born out in Serbo-Croatian (46a-b);

(46) a. ?* *Ovog studenta_i sam pronašla [knjigu t]*

this_{GEN} student_{GEN} am found book_{ACC}

‘Of this student I found the book.’

b. **Koga_i si pronašla [knjigu t]*

wh_{GEN} are found book_{ACC}

‘Of whom did you find the book?’

(Zlatić, 1997)

4.2 Case features are outside DP/ $N^{\max}P$

In the previous section, I have established the view from (Bošković, 2013) that DP/ $N^{\max}P$ is a phase boundary in the syntax. This section will explain how this is an important assumption for the solution to the puzzle as to why case features cannot mark politeness.

A crucial minimalist assumption here is that case features are not interpretable, or not transferrable to LF. To be more specific, case features are seen as those features that activate linguistic items so that they could be targets of syntactic operations (Chomsky, 2000). Therefore, case features have nothing to do with semantic interpretation. Or, to put it in another way, case features are only syntactic features and phonological features, and never semantic features. Intuitively, this is because, different from features like phi features, there is no systematic correspondence between case features and a particular notion/meaning. For example, it is never attested that in a language *X* where the case (or case values) of *A* systematically triggers semantic interpretation *B*. *A* might vary where *B* stays constant. As an illustration, observe the following examples from Svenonius (2006):

³⁴ Similarly, ‘deep’ adjunct extraction is also banned in Serbo-Croatian (Bošković, 2013).

(47) I heard him perform a sonata.

(48) Their destruction of the city was unnecessary.

In an Exceptional Case Marking (ECM) construction like (47), the third person masculine pronoun *him* is the agent and it bears accusative case; in (48), where nominalization is involved, the pronoun *their* denoting the plural destroyers of the city bears genitive case. (47-48) show that expressions that denote the agents of the sentences have case variations depending on their syntactic environment and therefore there isn't a systematic connection between the semantics of being an agent and accusative/genitive case.

As can be seen from (47-48), case is determined by the syntagmatic relation it has with the external environment of the case bearer. I have introduced in Section 4.1 the premise of the analysis is that DP/N^{maxP} is a Phase, which is relatively high. Given that case has to be determined and assigned by the elements that are outside of the nominal projection, this predicts that the projection of case features should be higher than DP/N^{maxP} projection. In fact, that case features are outside of DP has already become a standard view. For concreteness's sake, I will follow Neeleman and Szendrői (2007) and assume that there is a universal KP projection above DP (or N^{maxP}).

As already explained at the beginning of Section 4., the crux of the answer as to why case features cannot mark politeness lies in the fact that in the syntax, due to the PIC, case features cannot interact with HON feature to satisfy the requirement in (34), which I repeat as (49):

(49) Syntactic Requirement of HON

HON requires a feature in the syntax (in languages that do not have a dedicated spell-out rule for polite addressee pronouns)

(Or HON requires a syntactic feature for it to be licensed).

Note that this requirement presupposes that the feature that licenses HON should exist in the syntax. For the existence of some syntactic features, I take as evidence whether they are morphologically marked or not. As it turns out, the features marking politeness that trigger LF impoverishment rules as in typological **Patterns** 2,3,4,5,6,7, i.e., FEM, PL, DUAL, PAUCAL and REFL are all morphologically marked features or values of features according to standard morphological views.

I will give sample derivations of a possible polite addressee pronoun (ie. Italian, 50) and an impossible polite addressee pronoun (ie. a hypothetical case marked polite addressee pronoun, 51), showing that the syntactic requirement of HON must be checked somewhere in the syntax and a phase boundary will block this checking.

(50) Derivation of Italian polite addressee pronoun *lei*

a.

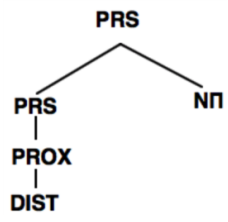

b.

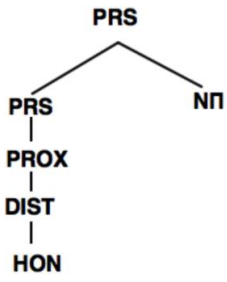

c.

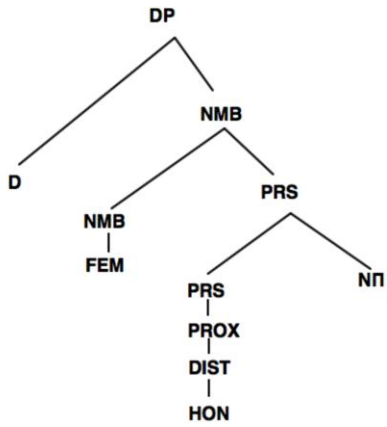

d.

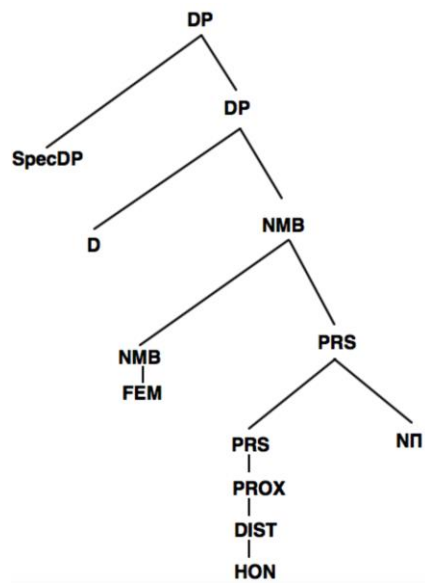

e.

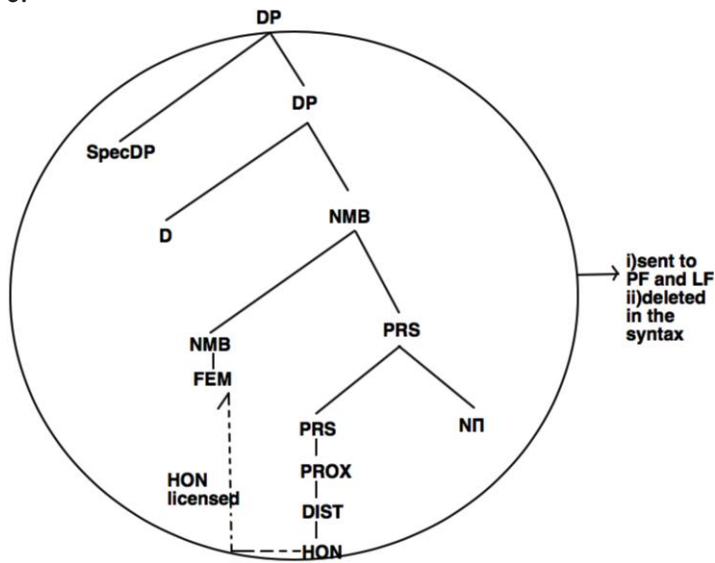

(-----> line indicates HON searching for a licensing feature and being licensed)

f. $FEM \rightarrow \emptyset / [_ _ HON]$ (Impoverishment rule at LF)

g. $PROX \rightarrow \emptyset / [_ _ DIST HON]$ (Impoverishment rule at PF)

h. $\{ D DIST FEM \} \rightarrow /lei/$ (Vocabulary Insertion rule at PF)

(51) Derivation of hypothetical case marked polite addressee pronoun

a.

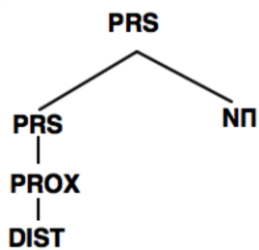

b.

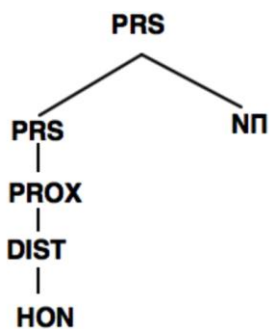

c.

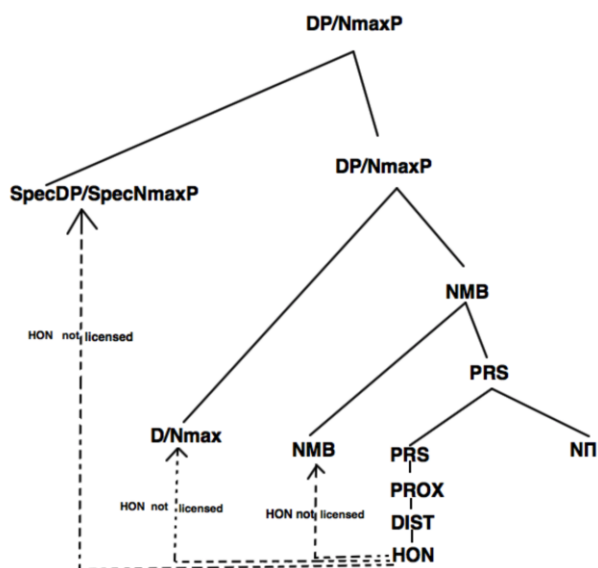

d.

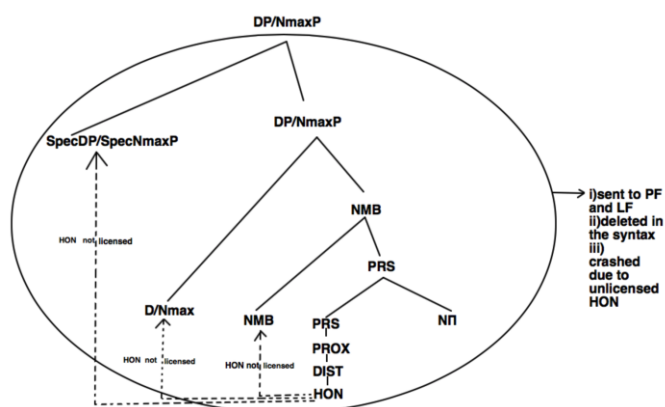

f.

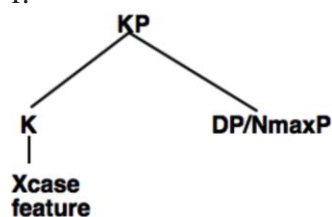

(Hypothetical merging of case feature X, which is too late to license HON.)

4.3 Case spreading: an apparent counter-example

As we have seen so far, although it is à priori a most ideal option to mark politeness with case features, due to a locality condition and the syntactic requirement of HON, this option is ruled out. So far, what needs to be done in order to make the analysis of this paper more complete is to account for an apparent counter-example to the hypothesis proposed in this paper. If, as I have proposed, case features cannot interact with HON in the syntax due to the fact that case features cannot interact with features inside the DP/N^{max}P phase boundary, then it goes without saying that case features should not interact with other DP/ N^{max}P internal features as well. However, this does not seem to be true for the phenomenon of case

spreading in the nominals: for example, in German and Icelandic, a range of modifiers, eg. demonstratives, adjectives and numerals, can bear the case of the noun.

(52) German (the demonstrative bears case)

Dieser Mann sucht nach diesem
this.NOM.SG.MASC man. NOM.SG.MASC is looking for **this.DAT.SG.MASC**
großen Hund
big.DAT.SG. MASC dog.DAT.SG.MASC

‘This man looks for this big dog.’

(53) Icelandic (the adjective bears case)

litl-ir snigl-ar
little-NOM.M.PL snail-NOM.M.PL

‘little snails’

(54) Icelandic (the numeral bears case)

fjór-a snigl-a
four-ACC.M.PL snail-ACC.M.PL

‘four snails (ACC)’

(Norris, 2014)

This type of agreement between the head noun and other DP/N^{max}P internal modifiers are called (nominal) concord in the literature, which is common in many languages. Not only case features can undergo concord, other features can too. For example, French noun phrase have number and gender concord:

(55) French gender and number concord

le-s beau-x ami-s
the.PL beautiful. (MASC.).PL friends. (MASC).PL

In fact, in Estonian, a range of nominal internal modifiers (adjectives, numerals, determiners, demonstratives and quantifiers) show case (and/or number) concord with the controlling noun:

CATEGORY	ESTONIAN (ADESSIVE)	ENGLISH
NOUN	<i>tigu-de-l</i>	snails (adessive)
ADJECTIVE	<i>kollas-te-l tigu-de-l</i>	yellow snails (adessive)
NUMERAL	<i>nelja-l teo-l</i>	four snails (adessive)
DETERMINER	<i>millis-te-l tigu-de-l</i>	which snails (adessive)
DEMONSTRATIVE	<i>nende-l tigu-de-l</i>	these snails (adessive)
QUANTIFIER	<i>kõiki-de-l tigu-de-l / kõigi-l tigu-de-l</i>	all snails (adessive)

Table11: Elements in Estonian that show concord (Norris, 2014)

Different from concord, syntactic agreement involves the relation between constituents, like that between a predicate and a subject, or that between an anaphor and an antecedent. Concord describes the phenomenon within a constituent, like case spreading in nominals. Previously, scholars have tried to unify the type of agreement between subject and predicate with nominal concord by arguing that they are both syntactic operations (eg. Grimshaw 1991/2005, Mallen 1997, Sigurðsson, 1993, 2004; Svenonius 1993; Sigurðsson, 1993, 2004; Wechsler and Zlatic 2003; Koopman, 2006; Baker 2008, Kramer, 2009, Carstens, 2000, 2011, 2013, Danon 2011, Toosarvandani and van Urk 2012).

As an attempt to solve the paradox about case spreading like the German and Icelandic examples in (52-54), I adopt the view that concord in noun phrases is post-syntactic, which would make sure that case features do not interact with DP/ N^{max}P internal features at all in the syntax. Suggestions (e.g. in Chomsky, 2001; Chung, 2013) have been made in passing that maybe nominal concord and the type of agreement between a subject and a predicate are of different mechanisms. Ackema and Neeleman (2018: 394) point out that there could be a difference between syntactic agreement and nominal concord. Rather than a process of syntactic agreement, they are inclined to consider concord as a spell-out/morphological operation. Case is encoded above DP in a head (of KP), but could be realized morphologically on multiple heads in the DP, which would result a surface effect that looks like agreement between K and other heads³⁵ in the DP.

Based on Estonian, a language which has a very rich concord system (see Table 11), Norris (2014) developed a theory of number and case nominal concord. He considers concord as different from the mechanism involved in the kind of agreement between subject and predicate, too. Norris (2014) also argues that concord in noun phrases are post syntactic operations, belonging to the morphological module. Feature copying, rather than agreement is the responsible underlying mechanism that derives concord. Feature copying is regulated by dominance/inclusion, rather than c-commanding, which regulates subject-predicate agreement in the syntax. DP/N^{max}P internal modifiers acquire their case features (and other concord features) from a constituent that contains them. For this paper, that constituent is the DP/N^{max}P. On the surface, feature copying has the same effect as that of subject-predicate agreement, which make it looks like that the head noun agrees with DP/N^{max}P internal modifiers (see Norris, 2012, 2014 for a detailed analysis).

I assume an analysis of case spreading in nominals along the lines of Norris (2014) and

³⁵ Ackema and Neeleman (2018: 395) do not think agreement relations could be established between a head and something that is not a maximal extended projection, indicating that this is a why agreement between K and other DP internal heads are banned.

Ackema and Neeleman (2018). Specifically, I assume that K values the maximal projection DP/N^{maxP} (meaning the particular label ‘DP/N^{maxP}’) with case features and no lower heads or constituents within the DP/N^{maxP}—due to the immediate discard of the DP/N^{maxP} in the syntax triggered by K. My implication here is that the valuation of (the label) DP/N^{maxP} by K is immediately followed by the deletion of DP/N^{maxP} in the syntax.

Agree is standardly assumed to happen under c-command. In the Morphology module and within the DP/N^{maxP} projection, since DP does not c-command HON, HON cannot search for the case feature in DP. As to how case feature is mapped from (label) DP/N^{maxP} to DP/N^{maxP} internal elements, I consider it a trivial option for this paper and therefore remain agnostic. For example, this process could be realized by assuming that the spell-out of DP/N^{maxP} internal features look for the feature on the dominating node. Thus, DP/N^{maxP} internal elements change forms according to the case feature on the DP/N^{maxP} label.

Base on such a model of case spreading within a DP/N^{maxP}, I will give a DM style sample derivation for the dative object in (56). Note that the triangle in the derivations is an oversimplification of the internal structure of N/ADJ.

(56) German

Der	Mann	sucht	nach	dem
the.NOM.SG.MASC	man. NOM.SG.MASC	looks	for	the.DAT.SG.MASC
großen	Hund			
big.DAT.SG. MASC	dog.DAT.SG.MASC			

‘The man looks for the big dog.’

(57) DM derivation of case spreading

a.

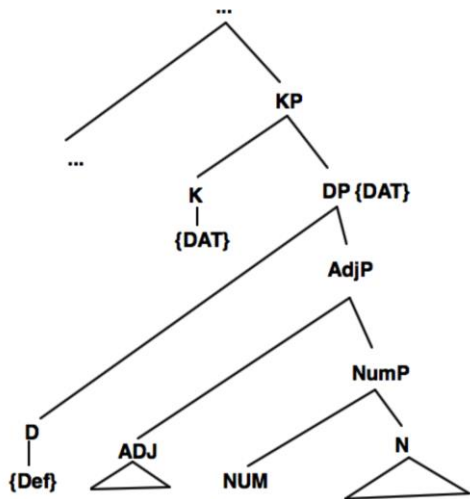

b.

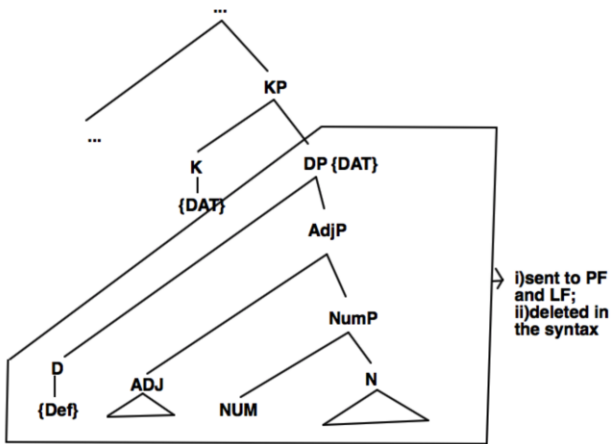

c.

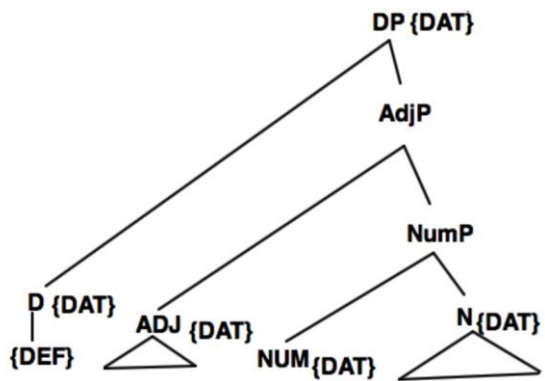

d.

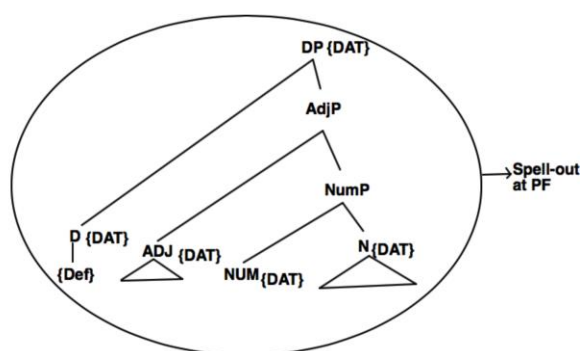

4.4 Interim summary: the syntactic requirement of HON and other impossible polite addressee pronouns

In order to obtain a second person semantics, the syntactic input on which impoverishment rules operate must be a structure where both PROX and DIST are available, with DIST dependent on PROX. Therefore, the syntax input that can deliver a second person polite semantics must be of the minimal feature structure [PROX DIST HON]. It cannot be [PROX PROX (PL / DUAL/PAUCAL/...) ...], as these inputs cannot be manipulated to generate a structure that would map to a second person semantics, assuming that there is only feature deletion and no feature insertion post-syntactically. Hence, first person singular ({D PROX PROX}) and first person exclusive plural ({D PROX PROX PL}) cannot be recruited as polite addressee pronouns. Apart from these predictions from Ackema and Neeleman (2018), the search requirement of HON (ie. the requirement that HON needs to be licensed by a feature in the syntax in languages that do not have a dedicated spell-out rule for polite addressee pronouns) in this paper also predicts other impossible polite addressee pronouns.

Since HON needs a feature in the syntax, and I have assumed that singular value of number is encoded by the absence of number feature while masculine value of gender are encoded by the absence of FEM gender feature (in a two-way/masculine vs feminine feature system) respectively, it follows that singular second person familiar pronoun and masculine (in a two-way/masculine vs feminine feature system) familiar pronouns cannot be used as polite addressee pronouns (for both singular and non-singular addressees). In the typology currently available to me, it is not attested that first person singular pronouns, first person exclusive pronouns, masculine personal pronouns (in a two-way/masculine vs feminine gender system) and second person singular pronouns are recruited as polite addressee pronouns. Therefore, the theory developed in this paper predicts at least two more impossible polite addressee pronouns than those already reported in Ackema and Neeleman (2018).

model requirements

predicted impossible addressee pronouns

Ackema and Neeleman (2018)	(a) pronominal feature structures proposed in Ackema and Neeleman (2018) (b) HON (c) LF/PF impoverishment rules	(a) 1st person singular pronouns (b) 1st person exclusive pronouns
This paper	(a) pronominal feature structures proposed in Ackema and Neeleman (2018) (b) HON (c) LF/PF impoverishment rules (d) Syntactic Requirement of HON (e) Locality condition on HON (f) Markedness condition on HON-triggered LF Impoverishment rules	(a) masculine personal pronouns (in a 2-way gender system) (b) 2nd person singular pronouns (c) hypothetical case-marked polite addressee pronouns (Apart from those predicted in Ackema and Neeleman 2018)

Table 12. Summary of predicted impossible polite addressee pronouns

5. Conclusion

Based on the typological patterns of polite addressee pronouns, this paper raises the issue as to why case features cannot mark politeness in these pronouns like tradition phi features and REFL do. This paper argues that this is due to the fact that case features are outside of DP/N^{maxP} phase of a pronoun and therefore cannot interact with HON feature, which sits inside DP/N^{maxP}. I have provided evidence that DP/N^{maxP} is a Phase boundary and is therefore subject to PIC. This renders the syntactic requirement of HON unsatisfiable by a case feature. This is why a hypothetical case marked polite addressee pronoun is not attested. I also addressed an apparent counter example to the hypothesis that case features cannot interact with DP/N^{maxP} internal features: nominal case spreading. I adopt Norris's (2014) idea that nominal concord is a post syntactic operation, ie. feature copying. There are still a number of unsolved problems regarding the morphology of polite addressee pronouns to be addressed in the remainder of this PhD project.

5.1 Independently available input structures

Following Ackema and Neeleman (2018), I assume that the syntactic inputs (the shaded column in Table 12) manipulated by LF and PF impoverishment rules in **Pattern 2,3,4,5,6,7** and 8 must be independently available in the syntax of the language in order to obtain the intended semantics and to be mapped to a phonological form. However, it is simply a stipulation that the impoverishment rules in **Pattern 2,3,4,5,6,7** and 8 are limited to a specific

set of syntactic input structures (or, that syntactic input structures in the shaded column in Table 12. are independently well-formed in the syntax). Without this stipulation³⁶, a language should allow many more hypothetical inputs for a polite addressee pronoun than those in the shaded column in Table 13. Given that impoverishment rules or combinations of impoverishment rules could lead to the loss of any features, many more such hypothetical inputs should be mapped to a phonological form in the language. It is not clear at this moment how one could justify such a *stipulation* (or explain such an *observation*³⁷.) on the input feature structures. I think this is a problem that deserves significant amount of attention in the remainder of this PhD.

	Syntactic input (must be independently available)	Morphological Output after LF impoverishment	Morphological Output after PF impoverishment
Pattern 2	{D PROX DIST HON PL}	{D PROX DIST HON}	
Pattern 3	{D PROX DIST HON DU}	{D PROX DIST HON}	{D PROX HON DU}
Pattern 4	{D PROX DIST HON (PL)}	{D PROX DIST HON}	{D DIST HON (PL)}
Pattern 5	{D PROX DIST HON FEM}	{D PROX DIST HON}	{D DIST HON FEM}
Pattern 6	{D PROX DIST HON PL/PAUCAL/DU}	{D PROX DIST HON}	
Pattern 7	{D HON PROX DIST REFL (PL)}	{D PROX DIST HON (PL)}	
Pattern 8	{D PROX DIST HON PL}		{D PROX DIST PL}

Table 13. Feature structure of polite addressee pronouns before and after impoverishment

5.2 The Threshold Requirement of HON

In Italian, HON requires the presence of the gender feature FEM. HON triggers the deletion of FEM at LF, which is we want to allow. What the system do not want to allow is that HON triggers FEM at PF, because this would give us a system where one uses masculine forms to be polite to women but one can't be polite to men—if in the meantime HON does not trigger the deletion of FEM at LF. This system apparently does not exist by looking at the current typology but it is easy to write a grammar that allows such a pattern. To avoid this unwanted grammar from being generated, there must be a constraint in the system that allows impoverishment triggered by HON at LF (ie. deletion of the features that HON selects) or allows HON to trigger deletion of person features at PF but nothing else. Such a constraint can be formulated as (58), which I call the Threshold Requirement of HON.

³⁶ In fact, this assumption goes against the ‘Richness of the Base’ hypothesis in Optimality Theory by Prince and Smolensky (1993), which says that there are no language specific restrictions on what could be a potential input. Or that ‘the set of possible inputs to the grammar is universal.’ (Smolensky, 1996). According to the Richness of the Base hypothesis, different constraint rankings, rather than different inputs, give rise to systematic differences in the phonemic inventories of different languages, for example.

³⁷ So far, it is not clear whether the well-formedness requirement of input feature structures in the shaded areas of Table 13. is a stipulation or observation. For it to be an observation, then one has to derive it from something else. For now, I suppose this something else refers to the notion of *learnability*. Additionally, the current draft has yet to give an example of how would a feature structure input that does not come from the shaded area of Table 13 would not work. I have not done so.

(58) The Threshold Requirement of HON

HON triggers deletion of features that HON is dependent on, after being licensed and rendered active via Agree-Link by features that HON selects in the syntax.

‘Dependent’ means either that HON is connected to marked features via selection and Agree-Link, or that HON is connected to person features because HON is structurally dependent on DIST and PROX. This restriction would tell us what kind of impoverishment is allowed and what kind of impoverishment is not allowed: morphologically marked features can be the target of HON-triggered LF impoverishment and only PROX and DIST can be the target of HON triggered impoverishment at PF, given that in order to keep the second person semantics, PROX and DIST must remain intact at LF; also in order to get the right form, morphologically marked features must remain intact at PF. An explanation as to why this kind of property pertains to impoverishment rules should be addressed in the Dissertation.

On the other hand, the Threshold Requirement’s explanatory power also manifests in that it could potentially explain why there is no impoverishment rules in dedicated polite addressee pronouns in many languages³⁸. This is because HON in dedicated polite addressee pronouns are never rendered active by a selected licenser because there is no such selected licenser (ie. politeness marking features).

But why should (58) mandate a dependency relation between HON and other features? One possibility is that it is just statistical accident that the typology supports (58) because certain patterns that defy (58) are just really rare that we haven’t found it yet (eg. as mention in the beginning of Section 5.2, there might be a system where you use masculine forms to be polite to women but you can’t be polite to men). This possibility indicates that our theory might be wrong because the current typology might be missing important bits of data.

I prefer another solution that assumes that our typology is correct but say something about the grammar. I tentatively give a proposal here without giving a full theory in this paper. I claim that the dependency relation between HON and features selected by HON or person features might be a consequence of HON-type agreement (60), which resembles the received model of traditional agreement (59) but is not entirely the same.

(59) Received model of agreement

Agreement transfers the values of interpretable features to matching uninterpretable features.

(60) HON-type agreement

Agreement transfers the values of interpretable features to ~~matching~~ uninterpretable features.

Compare (59) and (60), I crossed out the ‘matching’ in (60) because HON clearly does not match an uninterpretable orthogonal feature like PL or FEM. By the rule of thumb of traditional agreement relation, HON (ie. the probe) would be rendered active by an uninterpretable goal, which eventually lead to a process of the deletion of the uninterpretable

³⁸ Although in Dutch, as mention before, there might be evidence that there is impoverishment of number feature in the dedicated polite pronoun (Ad Neeleman p.c.); in Mandarin Chinese, I have assumed that HON is deleted in the plural form of second person. To have a clearer picture, I need more data on languages with dedicated polite addressee pronouns.

feature (ie. politeness marking features). Also, since Case features cannot render HON active due to locality, by Case filter requirement, the derivation crashes. Therefore, there is no case-marked politeness pronouns. This is also an alternative (but essentially the same) perspective of looking at the Case puzzle in this paper.

However, this proposal only explains the dependency between HON and the features that HON selects and does not explain the structural dependency of HON and PROX and DIST—although we know that the reason that HON depends on PROX and DIST is because the subject matter are all addressee pronouns.

All in all, there are many aspects of this partial solution that’s not clear to me at the moment and I wish to take more space to explain such a proposal in the Dissertation.

Additionally, traditional agreement relations involve a plethora of features types. Therefore, if I were on the right track here, I could imagine there be many more relationship type features like HON and FAM. For example, hypothetically, there might be HUMY (for ‘humble royal’) (61), HUMF (for ‘humble female’) (62), THREAT (for ‘threatening’) (63) and ROM³⁹ (for ‘romantic’) (64) features. I don’t have enough data to tell whether these features also recruit independently existing pronouns yet. This is another direction I could pursue, which needs a huge amount of typological work on my part.

(61) gū wú jí
 I-HUMY no ailment
 ‘I’m fine.’ (Classical Chinese)

(62) jiè ài jūnwáng
 I-HUMF love king
 ‘I love the king.’ (Classical Chinese)

(63) daka dɔhɔe-me ar ba-m dɔhɔe-khan-dɔ nãhãk’-laN
 rice put-2SG and neg-2SG put-if-TOPIC just-INCL.SUBJUNCT

 gɛr-gitic’-gɔtme-a ar boge-te-laŋ thəyə-me-a
 bite-lie-2SG.OBJ-INDIC and good-INST-INCL.SUBJ. **THREAT** kick-2SG.OBJ-IND

 ‘Put the rice down, and if you don’t put it down, I shall just bite you that you lie there,
 and I shall give you a good kicking’
(Santali; from Cysouw, 2005)

(64) qīng wú fányōu
 You-**ROM** no worry
 ‘Darling-you don’t worry.’ (Classical Chinese)

5.3 A more all-encompassing theory of polite addressee expressions

³⁹ In German, the polite *Sie* could be used in flirting situations, situations where there is a forbidden pupil-teacher relation or situations where a professor of really high status addressing a younger scholar even when the younger scholar already started to use *du* to address the really high status professor (Claudia Bruns and Victor Zimmermann p.c.). My conjecture about the flirting situation is that using the polite *Sie* gives the interlocutors the power of deniability, which befits the subtlety of the flirty parties.

Apart from having a dedicated polite addressee pronoun and recruiting existing personal pronouns in the pronominal paradigm, there are other ways to address the hearer politely as well, which would need to be explained and incorporated into a more general theory of polite addressee expressions. For example, DP subjects could be used instead of a pronominal form to address the hearer politely.

(65) Would **this young lady** want a cup of green tea? (this young lady=addressee)

(66) (Context: the doctor is visiting Kobus. Kobus has served coffee and asks the doctor the following questions.)

Wil **de dokter** ook een koekje? Of vindt u dat niet gezond?

wants the doctor also a biscuit or find you that not healthy

‘Would the doctor like a biscuit as well? Or do you think that’s not healthy?’

(Dutch; from Ackema and Neeleman, 2018)

5.4 HON needs a redefinition

In languages like Mandarin Chinese, as we have briefly seen in (10), it seems that the familiar feature FAM (for ‘familiarity’) would trigger the impoverishment operations in the 1st person inclusive plural pronoun. This calls for a theory where FAM and HON could potentially both be explained by one consistent Impoverishment model. One way of doing this is to redefine HON such that, for example, familiarity=HON, polite=HON HON. One could also use this mechanism to account for pronominal systems that have multiple politeness levels in addressee pronouns. For example, as mentioned in ft. 14, the most polite addressee pronoun in Fijian could be presented as stacking of multiple HONs. I repeat the Fijian data⁴⁰ in description (67-69) and propose a temporary and partial analysis here below (70). However, exactly how the derivation of polite addressee pronouns work where HON features are stacked needs to be qualified fully.

(67) When the paucal 2nd pronoun is used as a singular polite addressee pronoun, it is used to address brothers or sisters of opposite sex, elder siblings of the same sex.

(68) When the dual 2nd pronoun is used as a singular polite addressee pronoun, it is used to address mother-in-laws and farther-in-laws.

(69) When the plural 2nd pronoun is used as a singular polite addressee pronoun, it is used to address the village chief or generally old person who are respected. Dixon (1988)

(70) Derivation of Fijian polite addressee pronouns: super super polite vs. super polite vs. polite

a.

⁴⁰ The Fijian data here is inconclusive, as I have not interviewed any Fijian speaker to confirm which one of the three polite addressee pronouns is the most polite/familiar one.

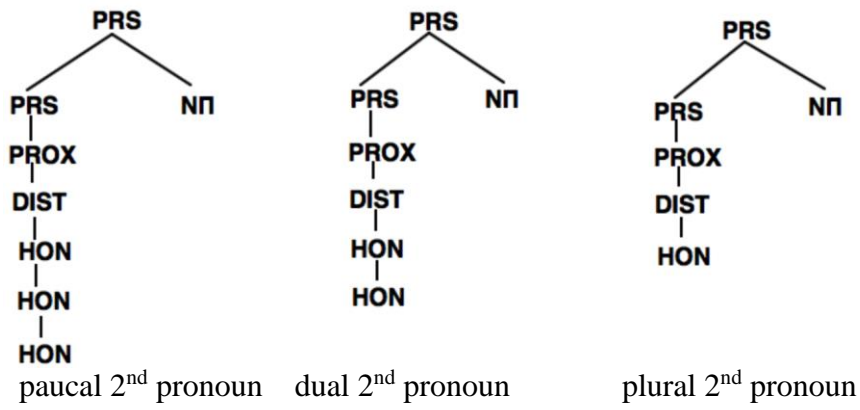

b.

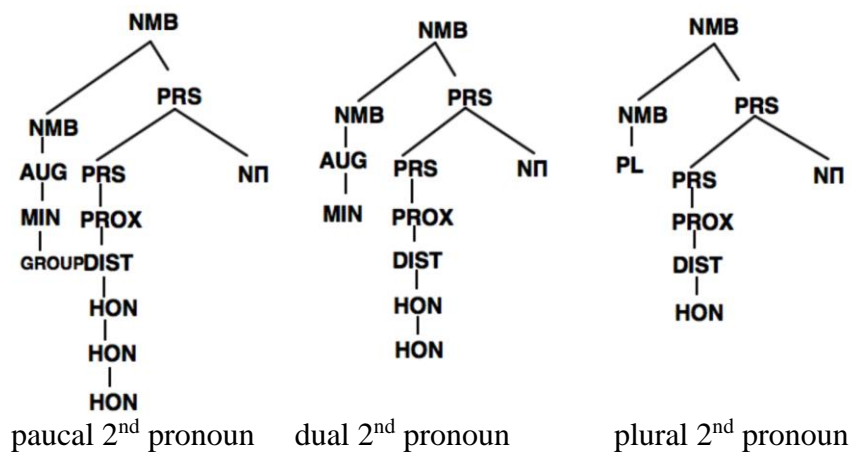

c.

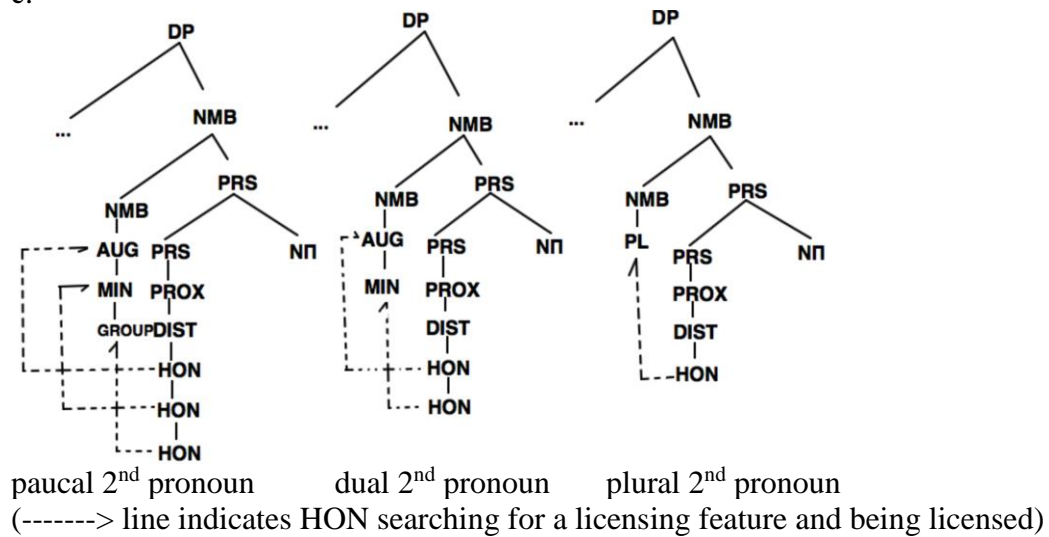

d.

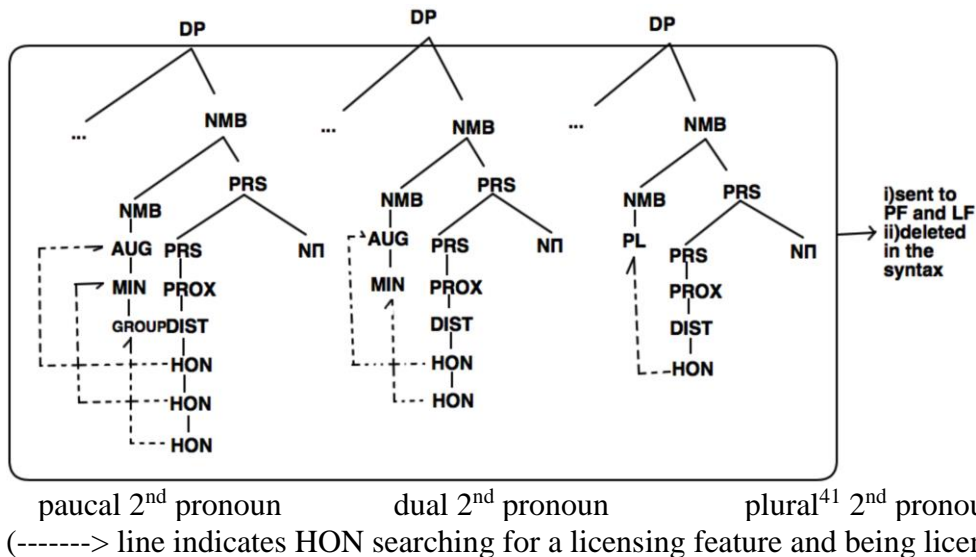

5.5 the marked status of HON

Another problem is about the marked status of HON. We have seen that HON causes neutralization via being a trigger of morphological impoverishment. For example, the distinction between plural and singular polite addressee pronouns are lost, leading to a syncretism between polite plural addressee pronouns and polite singular addressee pronouns in languages like French.

The problem arises if we look at **Pattern 8 Mandarin Chinese**, where PL triggers the PF impoverishment of HON. This fits well with the received view that marked features can not only be triggers of impoverishment rules but also targets of impoverishment rules. What's interesting is what is regulating this variation, so that one could explain why the same feature HON triggers impoverishment in French and, on the other hand, becomes the target of impoverishment in Mandarin Chinese.

5.6 FAM for 'familiarity'

By default, many languages (judging from current typology) have the HON feature. A very small minority might be best analysed with familiar feature. For example, in Brazilian Portuguese (Andrew Nevins p.c.), the familiar form seems to be the marked feature rather than HON. So there is a question about under what circumstances languages use the familiar feature rather than the honorific feature? The intuition is that if the analysis was simpler with the familiar feature than with the honorific feature then one would go for FAM rather than HON. It might be right that some languages base their system on FAM. But still there is a very large difference in the number of languages that seems to use the honorific feature. Almost all languages I have looked at seem to be analysable or better analysable using the honorific feature. So the question is, why is there such a difference? Why is honorificity the first hypothesis while familiarity only is the kind of assumption when honorificity doesn't seem to be the right analysis.

⁴¹ I'm not sure whether in the derivation it should be PL or AUG as it's not clear whether Fijian has an augmentive number system.

My point of view is that the asymmetry between HON and FAM is a superficial manifestation of the typology. The reason why some systems of honorification are based on FAM or HON or both might not be so easy to intuit, rather, my hunch is that there is a function $f(x,y,z,\dots)$, the value of which *lands* on something like a scale. I don't have a clear idea. However this thread of thought is inspired by Nevins (2016), where he proposes using essentially the same mechanism to model nonrhoticity (*r*-dropping). The following is a sketch of my explanation, assuming that the HON and FAM is the plus and minor values of the same feature (or they are independent features that have opposite semantic effects): e.g. HON increases the honorificity of the addressee and FAM decreases the honorificity of the addressee.



Figure 3. a hypothetical HON-FAM symmetry scale

$$(71) \text{Probability(HON)}=f(x,y,z,\dots)=ax+by+cz+\dots$$

$$(72) \text{Probability(FAM)}=f'(x,y,z,\dots)=a'x+b'y+c'z+\dots$$

(x, y, z, \dots , are factors such as social status, age, gender, kinship, intimacy, etc; a, a', b, b', c, c' are how much each factor in that specific language weighs.)

5.7 Experiment

Finally, I consider it a surprising bias that the majority of languages that have a polite distinction in addressee pronouns are of **Pattern 2** (e.g. French). To understand why this is the case, this paper aims to first complete the typological work of polite addressee pronouns. Then, I want to know whether this typological bias has anything to do with a learning bias related to how the cognitive system work in general.

References

- Abels, Klaus. 2003. Successive cyclicity, anti-locality, and adposition stranding. Doctoral dissertation, University of Connecticut.
- Abney, Steven Paul. 1987. *The English noun phrase in its sentential aspect*: Massachusetts Institute of Technology dissertation.
- Ackema, Peter, and Neeleman, Ad. 2018, MIT press. *Features of Person*.
- Arregi, Karlos. and Nevins, Andrew. 2012. *Morphotactics: Basque Auxiliaries and The Structure of Spellout*. Springer.

- Baker, Mark. 1996. *The polysynthesis parameter*. New York: Oxford University Press.
- Baker, Mark. 2008. *The Syntax of Agreement and Concord*. Cambridge: CUP.
- Bhatt, Rajesh and Martin Walkow. 2013. Locating agreement in grammar: an argument from agreement in conjunctions. *Natural Language and Linguistic Theory* 31/4: 951–1013.
- Boeckx, Cedric. 2005. Some notes on bounding. Ms., Harvard University, Cambridge.
- Bošković, Željko. 1994. D-structure, -criterion, and movement into -positions. *Linguistic Analysis* 24: 247-286.
- Bošković, Željko. 1997. *The syntax of nonfinite complementation: An economy approach*. Cambridge, MA: MIT Press.
- Bošković, Željko. 2008. What will you have, NP or DP? *Proceedings of NELS 37*.
- Bošković, Željko. 2005. On the locality of left branch extraction and the structure of NP. *Studia Linguistica* 59: 1-45.
- Bošković, Željko. 2013. Phases beyond clauses. In *Nominal Constructions in Slavic and Beyond*, ed by L. Schürcks, A. Giannakidou, U. Etxeberria, and P. Kosta, 75-128.
- Bošković, Željko. 2016. What is sent to spell-out is phases, not phasal complements
- Brown, Penelope and Levinson, Stephen. 1987. *Politeness: Some Universals in Language Usage*. Cambridge: Cambridge University Press.
- Carstens, Vicki. 2000. Concord in minimalist theory. *Linguistic Inquiry* 31(2). 319–355.
- Carstens, Vicki. 2011. Hyperactivity and hyperagreement in Bantu. *Lingua* 121(5). 721–741.
- Carstens, Vicki. 2013. Delayed Valuation: a reanalysis of "upwards" complementizer agreement and the mechanics of Case. ms., University of Missouri.
- Chomsky, Noam. 1970. Remarks on nominalization. In R.A. Jacobs and P.S. Rosenbaum (Eds.), *Readings in English Transformational Grammar*, pp. 184-221. Waltham, MA: Ginn-Blaisdell.
- Chomsky, Noam. 1995. *The Minimalist Program*. MIT Press, Cambridge, Ma.

- Chomsky, Noam. 2000. Minimalist inquiries: the framework. In Roger Martin, David Michaels & Juan Uriagereka (eds.), *Step by step: Essays on minimalism in honor of Howard Lasnik*, 89–156. Cambridge: MIT Press.
- Chomsky, Noam. 2001. Derivation by Phase. In M. Kenstowicz (Ed.), *Ken Hale. A Life in Language*, pp. 1-52. Cambridge, MA: MIT Press.
- Chung, Sandra. 1998. *The Design of Agreement: Evidence from Chamorro*. Chicago and London: The University of Chicago Press.
- Chung, Sandra. 2013. The syntactic relations behind agreement. In Lisa Lai-Shen Cheng & Norbert Corver (eds.), *Diagnosing syntax*, Oxford: Oxford University Press.
- Corbett, Greville. 2000. *Number*. Cambridge University Press.
- Corbett, Greville. 2006. *Agreement*. Cambridge: CUP.
- Croft, William. 2003. *Typology and Universals*, 2nd ed. Cambridge: Cambridge University Press.
- Corver, Norbert. 1992. On deriving left branch extraction asymmetries: A case study in parametric syntax. In *Proceedings of 22nd Conference of the North East Linguistic Society*, ed. by KIMBERLY BRODERICK, 67-84. Amherst: GLSA.
- Danon, Gabi. 2011. Agreement and DP-internal feature distribution. *Syntax* 14:297–317.
- Déchaine, Rose-Marie and Wiltschko, Martina. 2002. Decomposing Pronouns. *Linguistic Inquiry* 33, 409-422.
- Déchaine, Rose-Marie and Wiltschko, Martina. 2017. A formal typology of reflexives. *Studia Linguistica*. Ms. University of British Columbia
- Dixon, Robert M.W. 1988. *A Grammar of Boumaa Fijian*. Chicago: University of Chicago Press.
- Franks, Steven. 2007. Deriving discontinuity. In *Studies in Formal Slavic Linguistics*, ed. by Franc M and Rok Žaucer, 103-120. Frankfurt am Main: Peter Lang.

- Fukui, Naoki. 1988. Deriving the differences between English and Japanese: A case study in parametric syntax. *English Linguistics* 5, 249–270.
- Greenberg, Joseph. 1963. Some Universals of Grammar with Particular Reference to the Order of Meaningful Elements. In: J. Greenberg (ed.), *Universals of Human Language*, 73-113. Cambridge, MA: MIT Press.
- Grohmann, Kleanthes. 2003. *Prolific domains: On the anti-locality of movement dependencies*. Amsterdam: John Benjamins.
- Grohmann, Kleanthes, and Liliane Haegeman. 2003. Resuming reflexives. *Proceedings of the 19th Scandinavian Conference in Linguistics-Nordlyd* 31, 46-62.
- Grimshaw, Jane. 1991/2005. *Words and structure*. CSLI Publications.
- Grimshaw, Jane, and Vieri Samek-Lodovici. 1995. Optimal subjects. In J. Beckman, S. Urbanczyk, and L. Walsh, eds., *University of Massachusetts Occasional Papers in Linguistics 18: Papers in Optimality Theory*, GLSA, University of Massachusetts, 589-605.
- Grimshaw, Jane. 1997. Projection, Heads and Optimality. *Linguistic Inquiry* 28, 373-422.
- Halle, Morris. 1997. Distributed Morphology: Impoverishment and Fission. *MIT Working Papers in Linguistics* 30, 425–449.
- Harbour, Daniel. 2011. The Architecture of Features and the Derivation of Person. Ms. Queen Mary University of London.
- Harley, Heidi and Ritter, Elizabeth. 2002. Person and Number in Pronouns: A Feature-Geometric Analysis. *Language* 78, 482–526.
- Heim, Irene. 2008. Features on bound pronouns. In Daniel Harbour, David Adger & Susana Bejar (eds.), *Phi Theory: Phi-Features Across Modules and Interfaces*, 35–56. Oxford University Press.

- Heinz, Wolfgang and Matiasek, Johannes (1994). Argument Structure and Case Assignment in German. See Nerbonne et al. (1994), pp. 199-236.
- Helmbrecht, Johannes. 2003. Politeness distinctions in second person pronouns. In *Deictic conceptualization of Space, Time and Person*, Friedrich Lenz (ed.). Philadelphia: John Benjamins. 185–202.
- Ishii, Toru. 1999. Cyclic spell-out and the *that*-trace effect. In *Proceedings of the 18th West Coast Conference on Formal Linguistics*, ed. by Sonya Bird, Andrew Carnie, Jason D. Haugen, and Peter Norquest, 220-231. Somerville, Mass.: Cascadilla Press.
- Jeong, Youngmi. 2006. The landscape of applicatives. Doctoral dissertation, University of Maryland.
- Kayne, Richard. 2000. *Parameters and Universals*. Oxford University Press.
- Kiparsky, Paul. 1973. ‘Elsewhere’ in Phonology. In: S. Anderson and P. Kiparsky (eds.), *Festschrift for Morris Halle*, 93-106. New York: Holt, Rinehart and Winston.
- Koopman, Hilda. 2006. Agreement configurations: in defense of ‘Spec Head’. In Cedric Boeckx (ed.), *Agreement systems*, 159–199. Amsterdam: Benjamins.
- Kramer, Ruth. 2009. *Definite markers, phi-features, and agreement: a morphosyntactic investigation of the Amharic DP*: University of California, Santa Cruz dissertation.
- Lee, Kee-Dong. 1975. *Kusaiean Reference Grammar*. Honolulu: The University Press of Hawaii.
- Legendre, Géraldine, Paul Smolensky, and Colin Wilson. 1995. When is less more?: Faithfulness and minimal links in *wh*-chains. Presented at the MIT Workshop on Optimality in Syntax
- Mallen, Enrique. 1997. A minimalist approach to concord in noun phrases. *Theoretical Linguistics* 23(23). 49–77.
- Melchin, Paul. 2014. On DPs, NPs, and their respective pronouns. Paper

- presented at MO{L}T{H}, McGill, March 22-23.
- Nevins, Andrew. 2007. The representation of third-person and its consequences for person-case effects. *Natural Language and Linguistic Theory* 25:273–313.
- Nevins, Andrew. 2008. Cross-Modular parallels in the Study of Phon and Phi. In Daniel Harbour, David Adger & Susana Bejar (eds.), *Phi Theory: Phi-Features Across Modules and Interfaces*, 329–367. Oxford University Press.
- Nevins, Andrew. 2010. *Locality in Vowel Harmony*. Cambridge, MA: MIT Press
- Nevins, Andrew. 2011. Multiple Agree with Clitics: Person Complementarity vs Omnivorous Number. *Natural Language and Linguistic Theory* 29, 939–971.
- Nevins, Andrew. 2016. *Lectures on Postsyntactic Morphology*, UCL
- Noguchi, Tohru. 1997. Two types of pronouns and variable binding. *Language* 73, 773–797.
- Norris, Mark. 2012. Towards an analysis of Concord (in Icelandic). In *Proceedings of the 29th west coast conference on formal linguistics*, 205–213. Somerville, MA: Cascadilla Proceedings Project.
- Norris, Mark. 2014. *A Theory of Nominal Concord*. Doctoral dissertation, UCSC.
- Pannemann, Maren. 2007. *DP Acquisition as Structure Unravelling*, doctoral dissertation, Utrecht: LOT dissertation series 167
- Postal, Paul. 1969. On So-Called Pronouns in English. In: D. Reibel and S. Schane (eds.), *Modern Studies in English*, 201-223. Englewood Cliffs, NJ: Prentice-Hall.
- Preminger, Omer, and Maria, Polinsky. 2015. Agreement and semantic concord: a spurious unification. Ms.
- Preminger, Omer. 2017. ‘Assessing the morphosemantic program for phi-features: the prospects of a cross-modularly stable representation’. Talk given at 10th Brussels Conference on Generative Linguistics (BCGL 10)
- Prince, Alan, and Paul Smolensky. 1993. *Optimality Theory: Constraint interaction in*

- generative grammar. Technical Report, Rutgers Center for Cognitive Science, Rutgers University, New Brunswick, N.J., and Computer Science Department, University of Colorado, Boulder.
- Ritter, Elizabeth. 1993. Where's gender? *Linguistic Inquiry* 24(4). 795–803.
- Ross, John Robert. 1967/1986. *Infinite syntax*. Norwood: Ablex Publishing.
- Rullmann, Hotze. 2003. Bound-variable pronouns and the semantics of number. In Brian Agbayani, Paivi Koskinen & Vida Samiian (eds.), *Proceedings of WECOL 2002*, 243–254.
- Rullmann, Hotze. 2004. First and second person pronouns as bound variables. *Linguistic Inquiry* 35(1). 159–168.
- Saito, Mamoru, and Keiko Murasugi. 1999. Subject predication within IP and DP. In *Beyond principles and parameters*, ed. by KYLE JOHNSON & IAN ROBERTS, 167-188. Dordrecht: Kluwer.
- Sigurðsson, Halldór Ármann. 1993. The structure of the Icelandic NP. *Studia Linguistica* 47(2). 177–197.
- Sigurðsson, Halldór Ármann. 2004. Agree in syntax, agreement in signs. *Working Papers in Scandinavian Syntax* 74. 1–42.
- Simon, Horst. 2003. From Pragmatics to Grammar: Tracing the Development of Respect in the History of the German Pronouns of Address. In: I. Taavitsainen and A. Jucker (eds.), *Diachronic Perspectives on Address Term Systems*, 85–123. Amsterdam: John Benjamins.
- Smolensky, Paul. 1996. *The Initial State and richness of the base in Optimality Theory*. Technical Report 96-4, Department of Cognitive Science, John Hopkins University, Baltimore. [Rutgers Optimality Archive 154, <http://ruccs.rutgers.edu/roa.html>]
- Svenonius, Peter. 2001. Impersonal passives and the EPP: A phase-based analysis. In *Proceedings of the 18th Scandinavian Conference of Linguistics*, edited by Arthur

- Holmer, Jan-Olof Svantesson, and Åke Viberg, vol. 2, pp. 109–125. Travaux de l'Institut de Linguistique de Lund, Lund.
- Svenonius, Peter. 2001. On object shift, scrambling, and the PIC. In *A Few from Building E39: Working Papers in Syntax, Semantics, and their Interface*, edited by Elena Guerzoni and Ora Matushansky, MIT Working Papers in Linguistics, pp. 267–289. MITWPL, Cambridge, Ma.
- Svenonius, Peter. 2004. On the Edge. In: Adger D., De Cat C., Tsoulas G. (eds) *Peripheries. Studies in Natural Language and Linguistic Theory*, vol 59. Springer, Dordrecht
- Szabolcsi, Anna. 1994. The noun phrase. In *The Syntactic Structure of Hungarian*, vol. 27 *Syntax and Semantics*, 179–274. San Diego: Academic Press.
- Ticio, Emma. 2003. On the structure of DPs. Doctoral dissertation, University of Connecticut.
- Toosarvandani, Maziar, and Coppe van Urk. 2012. Directionality and intervention in nominal concord: Evidence from zazaki ezafe. Handout version of a poster at NELS 43, CUNY.
- Uriagereka, Juan. 1988. On government. Doctoral dissertation, University of Connecticut.
- Wechsler, Stephen. 2011. Mixed Agreement, the Person Feature, and the Index/Concord Distinction. *Natural Language and Linguistic Theory* 29, 999–1031.
- Wechsler, Stephen and Hyun-Jong Hahm. 2011. Polite Plurals and Adjective Agreement. *Morphology* 21, 247–281.
- Wechsler, Stephen and Larisa Zlatić. 2003. *The Many Faces of Agreement*. CSLI Publications.
- Willer-Gold, Jana, Boban Arsenijević, Mia Batinić, Nermina Čordalija, Marijana Kresić, Nedžad Leko, Franc Lanko Marušić, Tanja Milićev, Nataša Milićević, Ivana Mitić

Andrew Nevins, Anita Peti-Stantić, Branimir Stanković, Tina Šuligoj, and Jelena Tušek.

2016. Conjunct Agreement and Gender in South Slavic: From Theory to

Experiments to Theory. *Journal of Slavic Linguistics*, 24 (1) pp. 187-224.

Zlatić, Larisa. 1997. The structure of the Serbian Noun Phrase. Doctoral dissertation,

University of Texas, Austin.

Voilà \^-^/