

# UC Berkeley

## Dissertations, Department of Linguistics

### Title

Grammatical tone: Typology and theory

### Permalink

<https://escholarship.org/uc/item/5ck8s48r>

### Author

Rolle, Nicholas R.

### Publication Date

2018-07-01

**Grammatical tone: Typology and theory**

By

Nicholas Revett Rolle

A dissertation submitted in partial satisfaction of the

requirements for the degree of

Doctor of Philosophy

in

Linguistics

in the

Graduate Division

of the

University of California, Berkeley

Committee in charge:

Professor Larry Hyman, Co-chair

Professor Sharon Inkelas, Co-chair

Professor Peter Jenks

Professor Darya Kavitskaya

Summer 2018

**Grammatical tone: Typology and theory**

Copyright 2018  
by  
Nicholas Revett Rolle

## Abstract

Grammatical tone: Typology and theory

by

Nicholas Revett Rolle

Doctor of Philosophy in Linguistics

University of California, Berkeley

Professor Larry Hyman, Co-chair

Professor Sharon Inkelas, Co-chair

The topic of this study is grammatical tone (GT), which I define as a tonological operation that is not general across the phonological grammar, and is restricted to the context of a specific morpheme or construction, or a natural class of morphemes or constructions. In typologizing grammatical tone, I frame it in terms of dominance effects (Kiparsky & Halle 1977, Kiparsky 1984, Inkelas 1998), and divide GT into two types. Dominant GT systemically deletes the underlying tone of the target (with or without revaluation by a grammatical tune), while non-dominant GT does not systemically delete it. From a cross-linguistic survey of GT, I develop a typological principle called the dominant GT asymmetry, which states that within a multi-morphemic constituent, the dominant trigger is a dependent (e.g. a modifier of affix), and the target is a lexical head or a dependent structurally closer to the lexical head. In this way, dominance is always directed ‘inward’ within morphological hierarchical structure, supporting earlier statements such as Alderete’s (2001a, 2001b) ‘Strict Base Mutation’.

For any theoretical model of dominant vs. non-dominant GT, I show there are three problems that must be addressed: the origin problem (where does the grammatical tune come from), the erasure problem (why do the underlying tones of the target go unrealized), and the scope problem (what determines where the grammatical tune docks, i.e. its scope). To this end, I develop a novel model which I call Matrix-Base-map Correspondence (an extension of Output-Output Correspondence - Benua 1997) and combine it with Cophonology Theory (Inkelas & Zoll 2007).

Under this theory, the origin problem is attributed to floating tones which are part of the underlying representation of the trigger. A major claim is that there is no representational difference between dominant and non-dominant tone: they both involve floating tonemes undocked to a TBU in the input. I implement my model within Distributed Morphology (Halle & Marantz 1993), whereby triggers of dominant GT are not constructions (as in classic Cophonology Theory – Inkelas 1998), but rather individual vocabulary items (following Sande & Jenks 2017). Dominant triggers have a special cophonology which ranks a constraint enforcing dominance higher than default constraints. This dominant constraint should be understood as a special type of faithfulness: correspondence between a matrix derivation and an abstract base-map consisting of only unvalued tone bearing units, e.g. an input-output base-map  $//^{\text{Ⓣ}} + \tau\tau// \rightarrow \backslash\hat{\tau}\backslash$ . It is to this base-map output that the matrix output must be faithful in tonal shape, resulting in the target’s underlying tone going unrealized (addressing the erasure problem). The central insight here is that dominant GT should be characterized as a special type

of paradigm uniformity effect, a hypothesis referred to as dominance as transparadigmatic uniformity. In this way I derive dominance as faithfulness and not as markedness (Inkelas 1998) or a special construction constraint (McPherson & Heath 2016).

Finally, to address the scope problem I develop a theory in which syntactic structure is mapped to a hierarchical morpho-phonological tree via an operation at spell-out called hierarchy exchange. Within instances of dominant GT, a mother node in the morpho-phonological tree consists of the trigger of the grammatical tone (one daughter) and the target (the other daughter). The cophonology of the trigger scopes over the entire sequence, with cophonologies applying cyclically at each node resulting in ‘layers’ of grammatical tone. One advantage of Cophonology Theory is that it is intrinsically cyclic and thus captures the fact that dominance is always inward without stipulation.

A major component of this model is that hierarchy exchange preserves the inside-out derivational history of the syntactic module by referencing asymmetrical c-command. In this way, I conclude that syntax/phonology interface models which appeal to c-command are essentially correct, the most relevant being McPherson (2014) and McPherson & Heath (2016) which derive dominant GT scope via c-command. However, the model proposed in this study differs from them by having only indirect reference to c-command, mediated by hierarchy exchange. I conclude that the real legacy of c-command may not be linearization (as in Kayne 1994), but rather is in delimiting the scope of morphologically-triggered phonological operations.

In short, I posit a model which includes (i) floating tone representation, (ii) output-output correspondence (with abstract basemap induction), (iii) spell-out operations which apply in parallel, (iv) cyclicity within the morpho-phonological module, (v) indirect reference to syntactic structure and syntactic relations (e.g. c-command), and (vi) cophonologies triggered by DM vocabulary items. By combining disparate models and expanding on others, we arrive at a novel account of grammatical tone with extensive empirical coverage.

To Keren Rice

**Cobb:** *You create the world of the dream, you bring the subject into that dream, and they fill it with their subconscious.*

**Ariadne:** *How could I ever acquire enough detail to make them think that its reality?*

**Cobb:** *Well dreams, they feel real while we're in them, right? It's only when we wake up that we realize how things are actually strange. Let me ask you a question, you, you never really remember the beginning of a dream do you? You always wind up right in the middle of what's going on.*

**Ariadne:** *I guess, yeah.*

**Cobb:** *So how did we end up here?*

**Ariadne:** *Well we just came from the a...*

**Cobb:** *Think about it Ariadne, how did you get here? Where are you right now?*

**Ariadne:** *We're dreaming?*

**Cobb:** *You're actually in the middle of the workshop right now, sleeping. This is your first lesson in shared dreaming. Stay calm.*

[Inception \(Christopher Nolan 2010\)](#)

## List of symbols

Symbol	Meaning
▶	Dominant over (U+25BA)
≡	Non-dominant with respect to (U+1D1D)
ϕ	Has cophonology scope over (U+222E)
T	Toneme
H	High tone
M	Mid tone
L	Low tone
Ⓣ	Floating tone
Ⓜ	Floating H tone
Ⓜ	Floating M tone
Ⓛ	Floating L tone
Ⓜ	Docked floating H tone
Ⓜ	Docked floating M tone
Ⓛ	Docked floating L tone
∅	Unvalued
↓	Downstep
τ	Tone bearing unit (TBU)
*	Ungrammatical
x	Unattested
//	Input (or underlying representation)
\\	Output
///	Base input
\\\	Base output
[ ]	Surface structure
»	Constraint ranked above
S	Syntactic image at spell-out (input of ʒ)
ʒ	Phonological image (output of S) (U+01A8)
ϕ	Prosodic structure
μ	Mora
σ	Syllable
ω	Phonological word
φ	Phonological phrase
m	Morpheme
C	Construction
√	Lexical root
{X}	Vocabulary item label
<i>M</i>	Morphosyntactic content within a vocabulary item (VI)
<i>F</i>	Featural content within a vocabulary item (VI)
<i>P</i>	Prosodic content within a vocabulary item (VI)
<i>R</i>	Cophonology constraint ranking within a vocabulary item (VI)



## List of abbreviations

[+F]	Bears a feature F
A/ADJ	Adjective
ABC	Agreement by Correspondence
ABP	Agreement by Projection
BM	Basemap input-output mapping
BMMX-C	Basemap-Matrix Correspondence
<i>CoP</i> -scope	Cophonology-scope
Corr	Correspondence
CPT	Cophonology Theory
D/DOM	Dominant
DEM	Demonstrative
DM	Distributed Morphology
G	Grammar
GT	Grammatical tone
H	Unvalued host
Ĥ	Valued host
I	Input
LF	Logical Form
LPM	Lexical Phonology and Morphology
MPH	Morphology-in-parallel hypothesis
MX	Matrix input-output mapping
MxBM-C	Matrix-Basemap Correspondence
n/a	(data) not available
N/NEUT	Neutral
O	Output
OCP	Obligatory Contour Principle
OO-Corr	Output-Output Correspondence
OT	Optimality Theory
PF	Phonological Form
R/REC	Recessive
ROTB	Richness of the Base
TBU	Tone bearing unit
TCT	Transderivational Correspondence Theory
TETU	The emerged of the unmarked
Tr-OO-C	Transparadigmatic Output-Output Correspondence
VI	Vocabulary item

## Acknowledgments

At my time at Berkeley, I have sought to wear many hats, and if this has been even slightly successful it is due to the dedication of the many-hat-wearing faculty. Larry Hyman and Sharon Inkelas were co-chairs directing this dissertation, and they made a formidable and complementary team. Larry [I've never ]M<sub>[et a tone I didn't like]</sub> Hyman: your dedication to our field, phonology, and African linguistics is beyond inspiring, and it has been an absolute honor to work with one of the greatest experts on linguistic tone. In *The Wire*, they said some people were “natural police”. Larry: there has never been a more natural linguist than yourself. Sharon: I learned such an incredible amount from you over the years, in your open approach to ideas and data, in your contributions to morpho-phonological theory, and in how you handle the many facets of academia with such intelligence and diplomacy. And of course, thank you for indulging me in one meeting when I said that ‘basemaps’ were the lucid dreams of outputs. ☺

Other faculty played crucial roles in maturing my ideas and seeing projects through. Peter Jenks was a reader of this dissertation, and was integral in my “swimming upstream” from phonology to syntax, making my interface predictions sharper. Two connections in particular which Peter emphasized to me as relevant for this study were Nichols’ (1986) head-dependent distinction and Kayne’s (1994) Linear Correspondence Axiom. Peter: you are an interface-ist’s role model. Dasha was the outside committee member, and I thank her for discussions we’ve had such as how this work connects to other avenues of phonological inquiry. Line Mikkelsen was an incredible source of knowledge on syntax and especially Distributed Morphology, and encouraged me to ‘be bold’. Andrew Garrett was chair for much of my time here, and was an excellent teacher and guide throughout graduate school. Lev Michael and Chris Baier were wonderful to talk with about a range of topics, and may turn into tonologists yet. I must profusely thank Belen Flores and Paula Floro for their unflappable demeanor in the face of all things administration, and for the chocolates. You two have made my time at Berkeley as smooth as possible! I should also acknowledge departmental funding in 2017 in the form of an Oswalt grant to travel to Nigeria (and also funding from the Center for African Studies in 2015 for another trip).

Many Berkeley colleagues deserve thanks here. Zach O’Hagan was my first friend at Berkeley, and helped keep me grounded all these years when I start to float away. I will miss our high-brow gossip and discussion of clitic placement. Many thanks also to Ginny Dawson, Emily Clem, Nico Baier, Myriam LaPierre, Tessa Scott, Jack Merrill, Kelsey Neely, Sarah Bakst, Katie Sardinha, Florian Lionnet, Erik Maier, Clare Sandy, Hannah Sande, Karee Garvin, Herman Leung, Kenneth Baclawski, Matt Faytak, Meg Cychosz, Amalia Skilton, and countless others who have come and gone. The linguistics conversations I’ve had with you all over the years were one of the best parts of graduate school, and made the grind a little more manageable. I doubt I would’ve started this journey to grammatical tone without the discussions I had with visiting scholar Marine Vuillermet and our collaboration on analyzing Ese Ejja. In the wider linguistic community, discussions with Laura McPherson, Isaac Gould, Jeff Good, and Keren Rice were particularly influential (and thanks to Laura for reading a draft of part I of this thesis).

I could not have done fieldwork in Nigeria without the help of so many generous individuals. Jumbo Gift was my Izon consultant, and a superbly able one at that. My time in Port Harcourt was helped by Ozo-mekuri Ndimele, Ebitare Obikudo, and Daniel Ogum. Many other people have helped me over the years with all things Nigeria, including Ireh Iyioha and her family, Ron Schaefer, Francis Egbokhare, Tony Akhiale, Angela and Philomena Egbadon, Ethelbert and Ohoso Kari, Jackreece Charles, Otelemate Harry, Mark van de Velde, and Geoff Bacon.

My friends and family have been so supportive during my time at Berkeley, I cannot thank them enough. My wife Amy has been beside me through the years with my head deep in the game, and deserves an extra special acknowledgement for helping to edit this thesis! And thanks to my family (Tom, Debbie, Stephen, Shelley, Karen, Patsy), without whom none of this would be possible. So many friends in my life also deserve an entire paragraph here, and I'll thank each of you personally in the next dissertation.

# Contents

<b>Chapter 1</b>	Introduction to a study of grammatical tone .....	1
1.1	Grammatical tone: What is it? .....	2
1.2	Why (grammatical) tone? .....	3
1.3	What are the typological parameters for grammatical tone? .....	3
1.4	Theoretical importance: Again, why (grammatical) tone? .....	6
1.5	Overview of major claims .....	7
1.5.1	Starting point: A series of problems inherent to dominant GT .....	7
1.5.2	Substance of spell-out at the interface .....	8
1.5.3	GT claim 1: Dominant GT is floating tone plus a special cophonology .....	9
1.5.4	GT claim 2: The scope of the grammatical tune is established at spell-out .....	11
1.6	Structure of this study .....	12
<b>Part I</b>	<b>A TYPOLOGY OF GRAMMATICAL TONE .....</b>	<b>14</b>
<b>Chapter 2</b>	Grammatical tone (GT): What is it, where is it, and what is it for? .....	15
2.1	What is it: The anatomy of grammatical tone .....	16
2.1.1	Underlying tone .....	16
2.1.2	Tonological operations .....	17
2.1.3	Defining grammatical tone .....	18
2.1.4	GT components .....	28
2.1.5	Grammatically natural classes .....	32
2.2	Where is it and what is it for? .....	33
2.2.1	GT as exponence .....	33
2.2.2	Where is GT located in the world? .....	35
2.2.3	Expressing meaning .....	40
<b>Chapter 3</b>	GT dominance effects (and beyond) .....	46
3.1	Dominant and non-dominant grammatical tone .....	47
3.1.1	Overview .....	47
3.1.2	Dominance terminology in the literature .....	49
3.1.3	Dominant GT .....	53
3.1.4	Non-dominant GT .....	57
3.1.5	Dominance schema .....	61
3.2	Limited role of phonological markedness and tonological naturalness .....	62
3.3	GT dominance effects in action .....	67
3.3.1	Typology of interacting triggers .....	67
3.3.2	GT indomitability – An overview of non-undergoing exceptional targets .....	70
3.3.3	Repairs in GT application .....	79
3.3.4	Catalyzed dominance – Cases of exceptional triggers .....	85
3.3.5	Grammatical allotunes .....	86
3.3.6	Valuation windows with complex targets .....	89
3.4	Trigger/target asymmetries .....	90
3.4.1	Morphosyntactic asymmetries .....	91
3.4.2	Linear asymmetries with dominant triggers .....	103
3.5	Grammatical tone beyond dominance effects .....	104
3.5.1	Construct tunes .....	105
3.5.2	Paradigmatic GT .....	109

3.5.3	Grammatical tone sandhi .....	110
3.5.4	Scalar shifts .....	112
3.6	Summary .....	112
<b>Part II</b>	<b>A THEORY OF GRAMMATICAL TONE .....</b>	<b>115</b>
<b>Chapter 4</b>	<b>A model of the syntax/phonology interface: Design goals and design choices..</b>	<b>116</b>
4.1	The objective of this chapter .....	117
4.2	The patterns to capture: Dominance effects in GT .....	119
4.3	Desiderata for a model of GT .....	121
4.4	The design of the syntax/phonology interface .....	123
4.4.1	Pre-spell-out: The morpho-syntactic module.....	124
4.4.2	The substance of spell-out: Module-to-module mapping .....	128
4.4.3	Vocabulary insertion .....	132
4.4.4	Hierarchy exchange .....	134
4.4.5	Post-spell-out: From hierarchy exchange to cophonology-scope .....	142
4.4.6	Cophonology-scope and GT .....	147
4.4.7	Objects in specifier position.....	149
4.5	Transderivational correspondence: A need beyond cyclicity .....	150
<b>Chapter 5</b>	<b>Dominance as transparadigmatic uniformity via MxBM-C .....</b>	<b>155</b>
5.1	Overview .....	156
5.2	Matrix-Basemap Correspondence (MxBM-C) .....	158
5.2.1	Output-Output Correspondence (OO-Corr).....	158
5.2.2	From OO-Corr to MxBM-C .....	161
5.2.3	Types of transderivational uniformity effects .....	164
5.2.4	What is a possible basemap?.....	166
5.3	Dominant GT via MxBM-C .....	172
5.3.1	Selection of a basemap.....	172
5.3.2	Replacive-dominant GT .....	175
5.3.3	Subtractive-dominant GT .....	181
5.4	Comparison to non-dominant GT .....	183
5.4.1	Recessive GT .....	183
5.4.2	Neutral GT .....	192
5.5	Summary and comparison .....	194
5.5.1	Summary .....	194
5.5.2	Arguments against other models.....	195
<b>Chapter 6</b>	<b>Cophonology-scope .....</b>	<b>201</b>
6.1	Relevant background: Spell-out and spell-out operations.....	202
6.1.1	Spell-Out .....	202
6.1.2	Vocabulary insertion.....	203
6.1.3	Hierarchy exchange .....	204
6.2	From hierarchy exchange to cophonology-scope.....	207
6.2.1	Cophonology Theory (CPT) .....	207
6.2.2	Cophonology-scope ( <i>CoP</i> -scope) .....	208
6.3	Dominant GT via <i>CoP</i> -scope .....	210
6.3.1	A case study from Izon .....	213
6.3.2	Straddling GT - GT having two simultaneous hosts.....	227

6.4	Root-sponsored floating tone .....	230
6.4.1	Root-sponsored floating tone is not dominant .....	230
6.4.2	Are there cases of outward dominance? .....	235
6.5	Assessing how models handle the ‘scope problem’ .....	244
6.5.1	Models without intrinsic scope .....	246
6.5.2	Comparing models with intrinsic scope .....	256
6.6	Summary .....	262
<b>Chapter 7</b>	<b>Summary .....</b>	<b>263</b>
7.1	Summarizing dominant and non-dominant GT: A return to our three problems .....	264
7.2	Future inquiry .....	265
<b>References</b>	<b>.....</b>	<b>268</b>

# **Chapter 1**

## **Introduction to a study of grammatical tone**

### 1.1 Grammatical tone: What is it?

The purpose of this study is to provide a comprehensive typology and theory of grammatical tone. About half the world’s languages are **tone languages**, which are defined following Hyman as languages ‘in which an indication of pitch enters into the lexical realization of at least some morphemes’ (Hyman 2001:1368; Hyman 2006:229). This purposely broad definition includes tonally ‘dense’ languages with extensive tonemic contrast such as Cantonese and Vietnamese, as well as privative-culminative tone languages such as Japanese which only contrast high tone (H) vs. Ø, with one H per domain.

This definition emphasizes tone as part of the units of contrast which define different morphemes within a language. In the majority of tone languages, tone also shows an incredible breadth of **tonological operations**: toneme addition, deletion, replacement, displacement, assimilation, dissimilation, polarization, docking, spreading, floating, simplification, and many others. In many cases, these tonological operations are part of the general phonological system. For example, in the Nigerian language Yoruba, H (high) and L (low) tone spreads rightward onto an adjacent L or H tone.

- (1) / máyò mí rà wé /  
 má yò mí rà wé → [má yò mǐ rǎ wě]  
  
 ‘Mayomi bought books’

[Yoruba – Hyman 2007:6, citing Laniran & Clements 2003:207]

In contrast, this study focuses on those tonological operations which are *not* part of the general phonological system and are only licensed by specific grammatical conditions. This is what I refer to as **grammatical tone (GT)**, defined as a tonological operation which is restricted to the context of a specific morpheme or construction, or a natural class of morphemes or constructions. In other words, grammatically-conditioned toneme addition, deletion, replacement, shifting, assimilation, dissimilation, *etc.*

To exemplify, in the fellow Nigerian language Izon tone also spreads rightward but in a very different way from Yoruba. Morphemes fall into various tone classes depending on their tonal effect in context. Tone class A spreads a LH melody rightwards, class B spreads a H tone, and class C spreads L tone. In [MODIFIER NOUN] constructions, modifiers idiosyncratically belong to one of these three tone classes, shown in the table below (data collected during fieldwork by author on the Gbarain dialect). These operations cannot be attributed to general phonology.

- (2)

Modifier \ Noun		Tone patterns in isolation					
		[bùrù] ‘yam’		[námá] ‘meat’		[wàrí] ‘house’	
Tone class	A	èbì <sub>A</sub> ‘good’	èbì <sub>A</sub> <b>bùrù</b> [L <b>LH</b> ]	èbì <sub>A</sub> <b>námá</b> [L <b>LH</b> ]	èbì <sub>A</sub> <b>wàrí</b> [L <b>LH</b> ]		
	B	èndì <sub>B</sub> ‘that’	èndì <sub>B</sub> <b>bùrù</b> [L <b>HH</b> ]	èndì <sub>B</sub> <b>námá</b> [L <b>HH</b> ]	èndì <sub>B</sub> <b>wàrí</b> [L <b>HH</b> ]		
	C	kálá <sub>C</sub> ‘small’	kálá <sub>C</sub> <b>bùrù</b> [H <b>LL</b> ]	kálá <sub>C</sub> <b>námá</b> [H <b>LL</b> ]	kálá <sub>C</sub> <b>wàrí</b> [H <b>LL</b> ]		

[Izon – Author fieldnotes]



Notice two things which distinguish it from the Yoruba case: (i) the tones of the target (the noun) are completely overwritten and thus underlying tone is neutralized, and (ii) the spreading tone can be different from the tone of the trigger e.g. L-toned modifier spreading H and a H-toned modifier spreading L. GT data such as these constitute this study's empirical focus.

## 1.2 Why (grammatical) tone?

Tonal phenomena are part of the human capacity to use changes in pitch to convey meaning, together with stress, intonation, and prosody in general. Tonal phenomena are particularly important to linguistic inquiry by exhibiting a range of effects less often encountered in segmental phonology, e.g. the ability of tone to be 'mobile' and appear in a location different from its sponsor (Yip 2002: 133ff.), the ability of tone to 'interact at a distance' with much looser locality demands (Hyman 2011:225), and the ability of tonal operations to not be phonetically grounded, often radically (what Hyman 2011:238 calls its 'arbitrariness').

Tonal languages are rich with grammatical tone, which once established can blossom into some of the most intricate phonological patterns known to human language. A recent surge of in-depth descriptive and analytic work on GT has further fed our understanding, including African families Dogon (Heath 2008, a.o., McPherson 2014, McPherson & Heath 2016), Gur (Hyman & Olawsky 2004, Roberts 2016), Ijoid (Eferè 2001, Harry 2004, Harry & Hyman 2014), Bantu (Odden & Bickmore 2014, Marlo et al. 2015), and Nilotic (Andersen 1995, Trommer 2011), as well as families outside of Africa such as Oto-Manguean in Mexico (Cruz 2011, McKendry 2013, Campbell 2014, Villard 2015, McIntosh 2015, Sullivant 2015, Palancar & Leonard 2016, Zimmermann 2016) and Japonic lects across the Japanese islands (Kubozono 2016, Kubozono & Giriko 2018).

At the same time, we are still in a relatively young period for tonology in general and grammatical tone specifically, and do not yet have a clear sense of GT's 'axes of variation'. No comprehensive tonal typology has been worked out which delimits different types of GT and distinguishes them from tone sandhi phenomena, intonation, and demarcative boundary tones, to name some major 'landmarks' in the tonal literature. Sometimes this boils down to terminology: for the Izo case, what might be called replacive or construction tone by the Africanist might equally be described as left-dominant tone sandhi by a scholar of Chinese. But it also can be attributed to the fact that the state of 'prosodic documentation' is quite poor.

Approximately 50% of the world's languages are tonal, concentrated in several parts of the world with extensive documentation needs, e.g. Sub-Saharan Africa, Southeast Asia, Southcentral Mexico, and parts of Amazonia and New Guinea (Hyman 2011:198). Hammarström (2014:16) surveys the linguistic documentation levels of the world, highlighting the eleven countries with the lowest average documentation level (approximately averaging no more than a dictionary for each language in their country). From lowest to highest these are Laos, Nigeria, Bhutan, Papua New Guinea, Indonesia (Papua), Vietnam, the Philippines, Benin, Liberia, Cameroon, and Chad. All of these countries (except the Philippines) are areas where tone is either omnipresent or at least widespread. There is therefore a great amount of prosodic description still required before we can confidently assume a stable empirical target at which our typologies and theories can be aimed.

## 1.3 What are the typological parameters for grammatical tone?

One of the goals of this study is to establish core terminology for GT and the parameters along which GT systems vary, which is the topic of the first part of this study. I assume a property-driven approach to phonological typology (Plank 2001, Hyman 2009), in which individual instances of grammatical tone are deconstructed into a set of properties and the full typology is drawn from that inventory of GT tokens. As a starting point, we can differentiate the GT **trigger** as the morpheme or construction which licenses the tonological operation, the GT **tune** as the

toneme sequence which covaries with the trigger, and the GT **target** as the morpheme which is the intended undergoer of a tonological operation. In the Izon case above /èndì<sub>B</sub>/ ‘that’ + /wárí/ ‘house’ → [èndì<sub>B</sub> wárí] ‘that house’, the trigger is the modifier, the target is the noun, and the tune is the assigned pattern [HH].

In this study, I fully articulate these components (as well as others) by comparing and contrasting them against one another. What results is a list of ‘axes of variation’ which we can assess for each token of GT. As a sample, these include the following:

- (3) Sample of axes of variation of GT:
- a. **Tune-target relations:** how does the tune interact with the tone of the target? hypothetical possibilities include concatenation, replacement, deletion, blocking due to markedness, coalescence, among others
  - b. **Tune-trigger relations:** do these form one ‘exponent’ jointly? how different can the tonal value of the tune be from that of the trigger? how consistently does the tune co-occur with the trigger?
  - c. **Trigger-target relations:** how local do the trigger and target need to be? should locality be defined structurally (morpho-syntactically) or linearly (in the phonological string)? Are there asymmetries as to what can be a potential trigger and what a potential target?
  - d. **Allotuny:** does a GT tune exhibit ‘allotunes’ in complementary distribution? if so, is this conditioned by properties of the trigger? target? something else?
  - e. **Conditioning triggerhood and targethood:** are triggers/targets conditioned by their environment? are there exceptional triggers (normally non-triggering morphemes) and exceptional targets (non-undergoing units in the target domain)?
  - f. **Expression:** which grammatical categories can GT express? derivation/inflection? structural configurations such as [OBJECT VERB]? etc.

In this study, I frame the interaction between GT triggers, targets, and tunes in terms of morphological **dominance effects** (Kiparsky & Halle 1977, Kiparsky 1984, Inkelas 1998). A major typological generalization of my study is dividing GT patterns into two main types: **dominant GT** and **non-dominant GT**. Each of these has two sub-types. Dominant GT is split into **replacive-dominant GT** and **subtractive-dominant GT**, while non-dominant is split into **recessive non-dominant GT** and **neutral non-dominant GT**. These categories emerge from properties of the triggers, defined as the following:

- (4) Definitions of GT triggers (slightly redefined in chapter 3)
- a. **Replacive-dominant:** the automatic replacement of the underlying tone of the target, revalued with a grammatical tune (whether via a floating tone, spreading from the sponsor, *etc.*)
  - b. **Subtractive-dominant:** the automatic deletion of the underlying tone of the target, *without* revaluation by a grammatical tune
  - c. **Recessive-non-dominant:** the automatic non-application of the tune when a target is valued (occurs within privative-culminative systems)
  - d. **Neutral-non-dominant:** the lack of automatic replacement/deletion of the underlying tone of the target or automatic non-application of the grammatical tune (i.e. simple toneme concatenation)

It is a major typological finding of this survey that the GT type is controlled by the trigger, and not the target or tune.

An example of dominant GT was the Izon case in (2) above where the tone of the target were deleted and revalued. A case of non-dominant GT is found in another Nigerian language Hausa where the suffix /-n/ REFERENTIAL triggers a L tone which concatenates at the right edge of the noun without deletion and revaluation, shown below.

- (5) a. /jààkíí + -<sup>L</sup>n/ → jààkíin [jààkîn] ‘the donkey  
 b. /hársúnàà + -<sup>L</sup>n/ → hársúnààn [hársúnàn] ‘the languages’  
 [Hausa - Newman 1986:257]

Concatenation results in a falling tone when next to /H/ (as in a.) or vacuously applies with a /L/ tone (as in b.).

Two guiding questions which I address in this study are: (i) ‘when there are more than one trigger, which wins?’ (as asked in McPherson 2014 and Hyman 2016), and (ii) ‘are there any restrictions on what can be a GT target and what can be a GT trigger?’. For the first question, the typology reveals that the properties of the outermost trigger wins, with the properties of triggers (e.g. whether dominant, recessive, or neutral) maintained regardless of the content of the target. I call this the **outer dominance principle** for grammatical tone, supporting a common finding in dominance systems in general (Inkelas 1998). Cases which violate this principle are also identified and typologized.

Regarding the second question, a major finding of the survey is that dominant GT shows a trigger/target asymmetry but non-dominant GT does not. I refer to this as the **dominant GT asymmetry**, defined as in (6) and exemplified in (7).

- (6) **Dominant GT asymmetry**: within a multi-morphemic constituent, the dominant trigger is a dependent, and the target is a lexical head or a dependent structurally closer to the lexical head

(7)

Trigger → Target		Tone pattern	Non-dominant (e.g. docking)	Dominant (e.g. replacive)
<b>Grammatical/ Dependent</b>	→	<b>Lexical head</b>	✓ Yes	✓ Yes
a. Affix	→	Root	✓ Yes	✓ Yes
b. Modifier	→	Noun	✓ Yes	✓ Yes
c. Object	→	Verb	✓ Yes	✓ Yes
<b>Lexical head</b>	→	<b>Grammatical/ Dependent</b>	✓ Yes	* No
d. Root	→	Affix	✓ Yes	* No
e. Noun	→	Modifier	✓ Yes	* No
f. Verb	→	Object	✓ Yes	* No

This asymmetry is framed in typological neutral terms ‘lexical head’ (e.g. N of NP, V of VP) and ‘dependent’ which includes affixes and modifiers (following Nichols 1986). Thus in many cases, the trigger will be a grammatical item and the target will be a lexical item. In this table, row a. shows that if the trigger of the tonal pattern is an affix (such as a functional head) and the target is a lexical root, then the pattern can be either dominant or non-dominant. If the trigger and target are flipped (row d.), then only the non-dominant pattern is found. Parallel asymmetries exist with [MODIFIER NOUN] and [VERB OBJECT] constructions, illustrating that this asymmetry holds both within the word and also between words in phrases.

The dominant GT asymmetry is an important typological finding for two reasons. First, it strongly supports Alderete's (2001b:214) principle of 'Strict Base Mutation' developed for accentual systems, which concluded that affixes can be dominant over roots but roots are never dominant over affixes. Second, the fact that affixes (as well as modifiers) can systematically replace the tones of roots but not vice versa contradicts the widely discussed typological notion that root faithfulness takes precedence over affix faithfulness (McCarthy & Prince 1995, Beckman 1998, Krämer 2007, Urbanczyk 2011, Hall et al. 2016).

In total, by couching the survey of GT in terms of dominance we can profitably explore the parameters of GT as laid out in (3), while also tying GT to the extensive dominance literature based principally on stress/accent systems (as well as other dimensions, e.g. vowel length - Willard 2004), thereby connecting otherwise disconnected literature.

#### 1.4 Theoretical importance: Again, why (grammatical) tone?

Tone stands at the "outer limits of what is possible in phonology" (Hyman 2011:198), and is thus fertile testing grounds for phonological theory and the relationship of phonology to morphology and syntax. It has been instrumental in shaping phonological theory, e.g. establishing phonological representations as multi-tiered under Autosegmental Theory (Goldsmith 1980) and also establishing the existence of phonological scales and tone circles in tone sandhi (Chen 1987), seemingly without phonetic motivation.

In its ability to express grammatical meaning, grammatical tone is part of the large family of **non-concatenative morphology** which also includes segmental deletion, gemination, truncation, ablaut, consonant mutation, root-and-pattern morphology (e.g. Semitic templates), among others (Inkelas 2014:60ff for exemplification). Such phenomena equally stand at the 'outer limits' of morphology. Despite this, however, the contributions of **grammatical tone** to formal morphological and morphosyntactic theory have been less apparent - e.g. in Paradigm Function Morphology (Stump 2001), Distributed Morphology (Halle & Marantz 1993), Construction Morphology (Booij 2010a, 2010b), a.o. - theories which have largely developed based on morphemes as segments. GT has long been ignored in morphology textbooks (Matthews 1974, Booij 2005, Lieber 2009, Haspelmath & Sims 2010, Aronoff & Fudeman 2011), and is only marginally discussed in morphology handbooks and overviews (Spencer & Zwicky 1998, Hippisley & Stump 2017). This outsider status is further solidified due to much of the GT literature presented descriptively with specialists as the target audience, limiting cross-pollination with theoreticians of different stripes.

So, let us ask the question: what is the theoretical importance of grammatical tone? In the second part of this study I address this question directly, presenting a novel theory of grammatical tone with an emphasis on dominance effects. Grammatical tone directly touches on a number of tensions within morphological and phonological theory which play a recurrent role in model design throughout the literature. Some of these tensions are listed in (8) below, all of which walk the line between maximal restrictiveness and empirical coverage.

- (8) Tensions in morphological and phonological theory
  - a. **Locality**: how much sensitivity should our model have to non-local information? how is locality defined, e.g. linearly vs. hierarchically?
    - i. Globalism vs. localism (Bobaljik 2000, Embick 2010)
    - ii. Long distance effects and conditioning (Hyman 2011)
    - iii. Bracket erasure (Pesetsky 1979, Halle et al 1991, Orgun & Inkelas 2002, Inkelas & Zoll 2007)

- b. **Directionality**: how much sensitivity should our model have linearly (e.g. right to left vs. left to right conditioning) and hierarchically (e.g. inward vs. outward relations within morphological constituents)? is this sensitivity symmetrical or asymmetrical?
  - i. Inside-out derivations vs. global derivations
- c. **Modularity**: how separate are syntactic and phonological modules? is morphology a separate module? how much syntactic information can phonology access, and vice versa?
  - i. Direct reference view of the syntax-phonology interface (Kaisse 1985, McPherson 2014, McPherson & Heath 2016) vs. indirect reference (Selkirk 1980, 2009, 2011; Nespor & Vogel 1986) (discussion throughout Scheer 2011)
  - ii. What is the role of c-command in determining phonological patterns? conversely, what is the role of prosodic well-formedness in determining syntactic patterns?
- d. **Constituency**: what kind of phonological constituents are formed, and on what evidence? how much is this conditioned by syntactic structure?
  - i. Relationship between syntax and prosodic hierarchy (Match Theory - Selkirk 2009, 2011)
  - ii. Non-isomorphy between representations, e.g. bracketing paradoxes (Cohn 1989, Inkelas 2014:316ff.)
- e. **Serialism vs. parallelism**: within an input-output mapping, do constraints apply in parallel (Optimality Theory – Prince & Smolensky 1993), as opposed to rule-based serialism (e.g. as evidenced by extensive opacity)
- f. **Cyclicity (and cyclic effects)**: within a given derivation, is there one or more than one input-output mappings? if more than one, do the same exact constraints/rules apply, or can different ones apply?
  - i. Cyclic effects captured through output-output correspondence (Benua 1997), vs. Stratal OT (Kiparsky 2000, 2015, Bermúdez-Otero 2008, 2012)
- g. **Procedure vs. representation**: for a given output, how much should be attributed to the representation of the input (the primitives) vs. the procedure itself (the combinatorics)? (discussion in Bermúdez-Otero 2012:8)
  - i. Grammatical tone supporting an ‘item-and-process’ view of morphology (Inkelas 1998, McPherson & Heath 2016, Sande 2017) vs. an ‘item-and-arrangement’ one (Trommer 2011, Zimmermann 2016)? (terminology from Hockett 1954)

Grammatical tone provides a critical empirical phenomenon to examine each of these tensions.

## 1.5 Overview of major claims

### 1.5.1 Starting point: A series of problems inherent to dominant GT

A theory of GT starts with identifying the specific problems that any theoretician must address. I will focus on capturing the difference between dominant GT and non-dominant GT, and the asymmetries they show. To that end, consider the following example of replacive-dominant GT from the Nigerian language Kalabari.

(9)	námá	+	wá <sup>↓</sup> rí	+	améè	→	námá wá <sup>↓</sup> rí	améè
	animal		house		PLURAL		‘the animal(’s) houses’	
	[ N <sub>1</sub>		N <sub>2</sub>		PL ]			

[Kalabari – Harry & Hyman 2014]

These morphemes are shown on the left with their underlying tones and meaning, and on the right with their meaning and tone pattern in context. [N<sub>1</sub> N<sub>2</sub>] constructions in Kalabari exhibit replacive GT, whereby the tone of N<sub>2</sub> (here underlying /H<sup>↓</sup>H/) changes to a surface pattern [HL]

(the grammatical tune). We can isolate parts of this example and identify where the ‘problems’ (i.e. challenges – Trommer 2011) are for any GT model, as shown below.

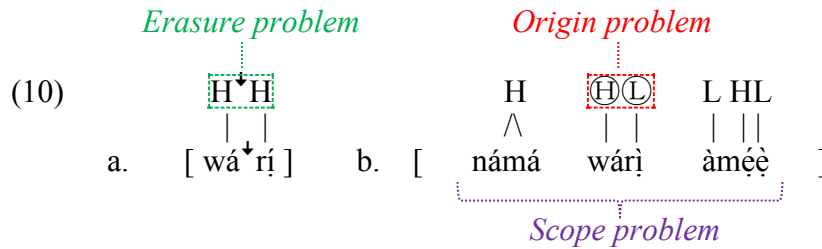

First, the **erasure problem** addresses by what mechanism are the underlying tones of the target deleted (i.e. go unrealized –  $N_1 H^\uparrow H$  at left in a.) when in the context of the trigger (to the right in b.). Second, the **origin problem** addresses where the grammatical tune [HL] comes from within in the derivation (e.g. from constraint ranking, floating tones in the input, simple allomorphy, etc.). Third, the **scope problem** addresses why the [HL] grammatical tune falls on  $N_2$ , and not on the other morphemes  $N_1$  and the plural marker. In other words, by what principle is the target of the GT operation established?

### 1.5.2 Substance of spell-out at the interface

To successfully address these problems, I develop a model of the syntax/phonology interface by using a collection of familiar parts from several different theories synthesized to form a novel theory. I assume the general architecture of the Minimalist Program (Chomsky 1995) couched within non-Lexicalist Distributed Morphology (Halle & Marantz 1993). One goal in service towards understanding GT is to fully articulate the substance of **spell-out**, conventionally understood as the mapping from syntax to phonology in the feed-forward modular conception of grammar adopted here. In addressing the substance of spell-out, I seek to add to our understanding from the perspective of phonology and phonological phenomena such as tone (‘swimming upstream’ so to speak), as it is my opinion that conceptions of spell-out suffer from syntactic bias.

I emphasize three distinct components of this interface: the **morpho-syntactic module**, the **morpho-phonological module**, and **spell-out** which relates the two modules.

(11) Morpho-syntactic module maps to morpho-phonological module via spell-out

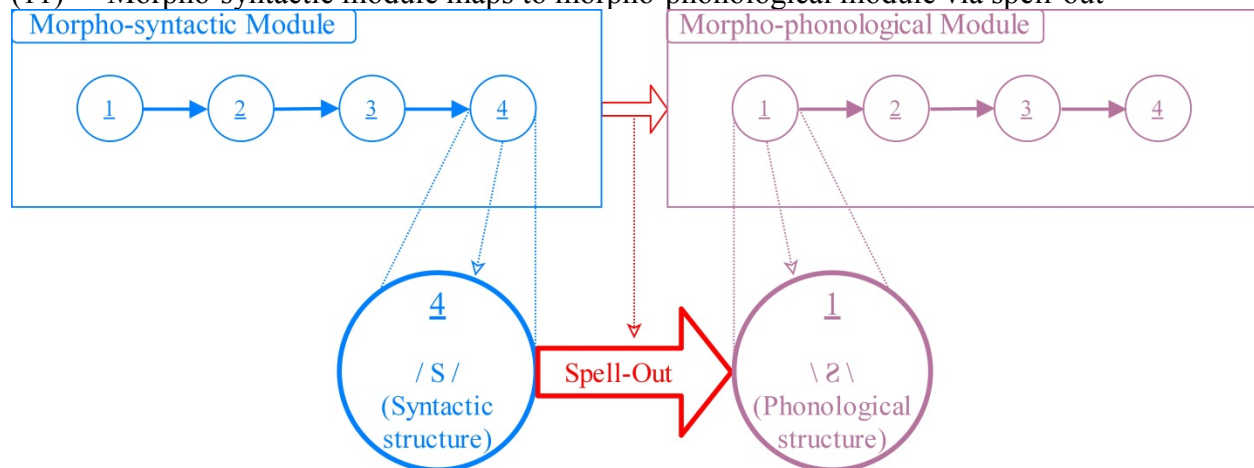

The morpho-syntactic module (in blue) consists of morpho-syntactic feature bundles (its primitives) subject to syntactic operations such as Merge (its operations). This is mapped to the morpho-phonological module (in purple) consisting of phonological strings and subject to a phonological grammar. Syntactic operations apply cyclically, and the output of last cycle is the input to spell-out (the red arrow). Spell-out maps this **syntactic image** (/S/) input to what I refer to as to a **phonological image** (an output \2\), which serves as the input to further phonological computation.

At the very least, spell-out consists of operations involved in what I call the **actuation of phonology** (as well as a cast of familiar DM/interface operations).

(12)	<b>Actuation of phonology:</b>	Spell-out operation	Provides
	a.	Vocabulary insertion	Phonological material/substance
	b.	Linearization	Phonological precedence
	c.	Prosodification	Phonological constituency
	d.	Hierarchy exchange	Phonological operation scope

All of these spell-out operations take place in parallel formalized within an Optimality Theoretic model, following what I call the **morphology-in-parallel hypothesis (MPH)**.

(13) **Morphology-in-parallel hypothesis (MPH)**

Spell-out operations involved in mapping the syntactic image / S / to the phonological image \ 2 \ take place in parallel within an OT architecture

Thus, while input-output mapping *within* a module is cyclic, the mapping from one module to another takes place strictly in parallel and as such is not cyclic. Although this premise of parallelism is at odds with the majority of DM (Embick & Noyer 2001, Arregi & Nevins 2012), a growing body of literature supports such a hybrid OT-DM model (Trommer 2001a, further detailed in Rolle accepted). Further, although I do not integrate this model within phase theory (Chomsky 2001), they are compatible if one still allows for parallelism at each phase cycle.

Two of these operations are critical for understanding grammatical tone: **vocabulary insertion** which inserts vocabulary items (VIs) containing phonological material, i.e. phonemes, tonemes, *etc.* (essentially phonological exponence), and **hierarchy exchange** which establishes morpho-phonological hierarchical relations (the morpho-phonological tree). I discuss these now.

1.5.3 *GT claim 1: Dominant GT is floating tone plus a special cophonology*

Let's return to the contrast between dominant and non-dominant GT, e.g. replacive-dominant GT replaces all tone of the target while neutral-non-dominant GT simply concatenates with the tone of the target. The first theoretical claim I make in this study is that these GT types are representationally equivalent: they both involve floating tones. This addresses the origin problem. For example, consider the following data from Hausa (Newman 1986, Inkelas 1998).

(14)	a.	Dominant	/ jìmináá + - <sup>Ⓛ</sup> úú / →	<b>jìmin</b> -úú	[jìminúú]	‘ostriches’
	b.	Non-dominant	/ jààkíí + - <sup>Ⓛ</sup> n / →	jààkíí-n	[jààkîn]	‘the donkey’
[Hausa - Newman 1986:252,257]						

The suffix /-<sup>Ⓛ</sup>úú/ PLURAL in a. is idiosyncratically specified as dominant. The tones of the target noun are deleted and the floating <sup>Ⓛ</sup> docks to it (shown in bold and boxed in the output). In contrast, the suffix /-<sup>Ⓛ</sup>n/ REFERENTIAL in b. is non-dominant, and as such the floating tone docks

to the target without replacement. The difference between the two is that the vocabulary item ( $\approx$ lexical item/morpheme) corresponding to dominant /-<sup>Ⓛ</sup>úú/ is endowed with a special cophonology which results in target tone deletion (Cophonology Theory – Inkelas & Zoll 2007, Sande & Jenks 2017). In contrast, non-dominant /-<sup>Ⓛ</sup>n/ is endowed with no special cophonology, and covaries with only default phonology. Hypothetical vocabulary items (VIs) are below, where the shorthand for the special cophonology is DOMINANT » DEFAULT within the VI.

- (15) Vocabulary items with and without special cophonologies
- |  |     |  |
|--|-----|--|
| Dominant Hausa VI<br>[PLURAL]<br>/- <sup>Ⓛ</sup> úú/<br>DOMINANT » DEFAULT | vs. | Non-dominant Hausa VI<br>[REFERENTIAL]<br>/- <sup>Ⓛ</sup> n/<br>DEFAULT (» DOMINANT) |
|--|-----|--|

A noted advantage of Cophonology Theory is its ability to handle morphologically-conditioned phonological operations such as dominant GT (Inkelas 2014:80). However, unlike mainstream Cophonology Theory couched within construction grammar and item-and-process morphology (e.g. Inkelas & Caballero 2013), I implement it within DM where the triggers of cophonologies are VIs and not the constructions themselves.

The central insight which I seek to formalize in this chapter is that dominant GT should be characterized as a special type of paradigm uniformity effect. I call this hypothesis **dominance as transparadigmatic uniformity**. In short, within dominant GT all outputs have a uniform tone shape which has the advantage of providing a more consistent cue for the grammatical category of the trigger, but sacrifices the lexical contrast of the target. In contrast with non-dominant GT, outputs do not have a uniform form and thus maintain lexical contrast unambiguously, but at the cost of having a less delimited cue for the trigger. I take this trade-off to be the central tension in the realization of grammatical tone.

I formalize the contents of the dominant cophonology through **Output-Output Correspondence** (OO-Corr - Benua 1997), and in this way my model of dominance resembles Alderete’s (2001a, 2001b) Antifaithfulness theory. Under OO-Corr, outputs are in correspondence with both inputs as well as (certain) other outputs with which they are morphologically related, and by virtue of being in correspondence they may come to influence the phonological form of one another. In order to handle GT dominance effects, I develop an extension of OO-Corr called **Matrix-Basemap Correspondence** (MxBM-C), in which a matrix input-output mapping is in correspondence with one or more basemap input-output mappings. I argue that the traditional criteria within OO-Corr that bases be ‘real outputs’ is invalid, and in eliminating it state that matrix outputs can be in correspondence with **induced basemaps** consisting only of abstract phonological material. This is shown below with the Hausa data.

- (16) Dominant GT via Matrix-Basemap Correspondence

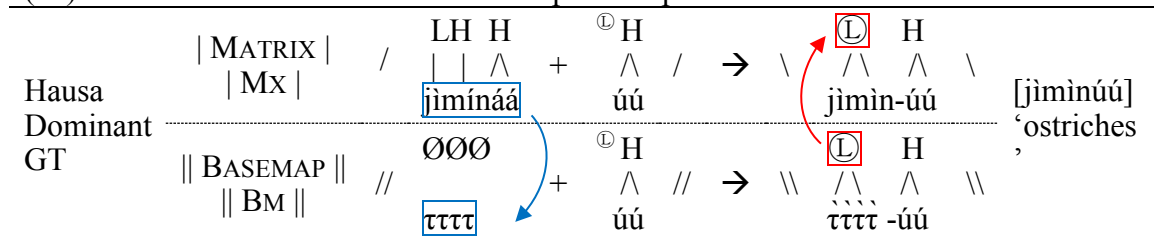

The matrix input in the top left consists of the target /jímínáá/ and trigger /-<sup>Ⓛ</sup>úú/. Dominance is the result of this trigger subcategorizing for correspondence to an abstract basemap called the



induced basemap //ττττ -<sup>⓪</sup>úú// consisting only of abstract tone bearing units abbreviated as τ (the basemap is provided in double slashes to distinguish it from the matrix). In the basemap, the floating tone from the trigger transparently maps to the toneless target, resulting in a basemap output \\ττττ-úú\\. It is to this basemap output that the matrix output must remain faithful via an OO-Corr constraint  $O_{MX}O_{BM}(TONE)$ , which is higher ranked than IO-IDENT and markedness constraints due to the special cophonology in the dominant VI. This enforces correspondence between the matrix and basemap outputs, resulting in the attested surface form [jìminúú].

The most important take-away from this brief discussion is that dominance is due to faithfulness to a related output form (albeit an abstract one). I will contrast this view with several others. One set are culminativity+competition, theories such as Revithiadou’s (1999) Headmost Wins, in which dominance results from competition between the underlying tones of the target and the grammatical tune co-varying with the trigger. I show that such theories are inadequate on the grounds that the majority of GT patterns do not involve culminativity and freely allow co-occurring tones sponsored from different morphemes (e.g. non-dominant GT in Hausa in (14)b.). Another model attributes the origin of the grammatical tune to a markedness constraint (Inkelas 1998) or a construction constraint (McPherson 2014, McPherson & Heath 2016). I show that while this successfully accounts for the erasure problem, it suffers with respect to what we discuss next: the scope problem.

#### 1.5.4 GT claim 2: The scope of the grammatical tune is established at spell-out

The second theoretical claim I make in this study is that the scope of dominant GT patterns is established at spell-out, via the operation hierarchy exchange. Consider a toy example illustrating spell-out below. The syntactic image from the morpho-syntactic module is at the left, which maps via spell-out (the red arrow) to the phonological image at right.

(17) Syntactic structure mapped to a morpho-phonological tree

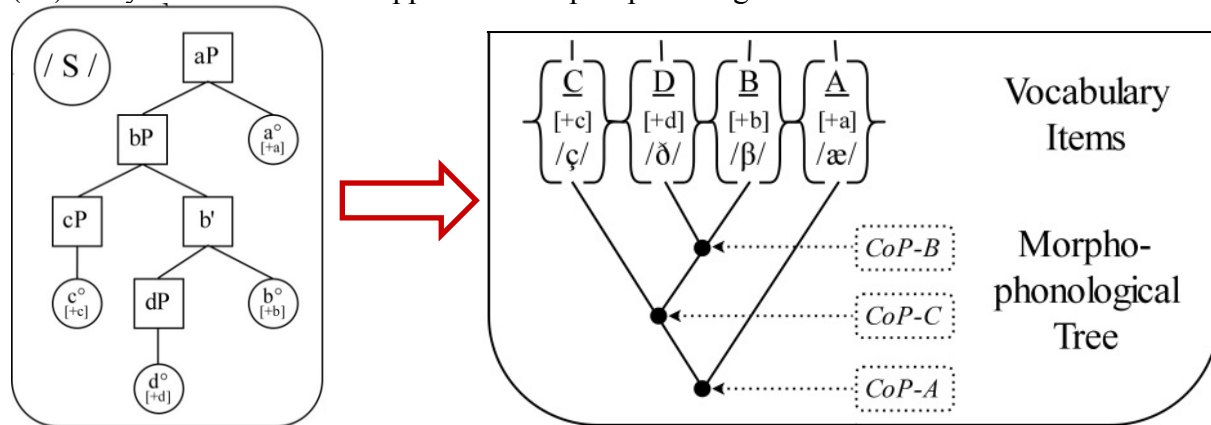

As said above, vocabulary insertion maps terminal syntactic heads to vocabulary items with phonological substance (i.e. the string of { } bundles). Given our assumptions of spell-out as morphology-in-parallel, phonological operations conceivably could (i) apply as a part of spell-out in parallel to morphological operations, (ii) apply after spell-out but globally where all VIs are in the phonological input simultaneously, or (iii) apply cyclically. It is this last option which I advocate for.

If phonology applies in cycles, what defines the cycles? I claim that cycles are defined by the operation hierarchy exchange, which translates a hierarchical syntactic structure (created by cyclic application of Merge) to a **morpho-phonological tree** which connects vocabulary items at binary nodes (as shown in the diagram above). Informally, this operation exchanges syntactic

notions of ‘upward’ and ‘downward’ for morphological notions of ‘outward’ and ‘inward’. The most embedded elements of the syntactic tree are also the most embedded elements within the morpho-phonological object, i.e. roots/lexical heads. Higher heads and specifiers which merge with the lexical head are mapped to ‘outer’ positions within the morpho-phonological tree.

Hierarchy exchange preserves the inside-out derivational history of the syntactic module by referencing **asymmetrical c-command**. In this way, I conclude that interface models which appeal to c-command are essentially correct, the most relevant being McPherson (2014) and McPherson & Heath (2016) which derive dominant GT scope via c-command. However, I differ from this direct reference model in that my model refers to c-command only indirectly, mediated by hierarchy exchange. I provide arguments in favor for indirect reference, but the main take-away point is this: asymmetrical c-command plays a critical role in delimiting the scope of morphologically triggered operations, a hypothesis which should be tested with data beyond GT.

The main function of hierarchy exchange is to establish what I call **cophonology-scope** (an extension of ‘stem scope’ – Inkelas & Zoll 2007). In the morpho-phonological tree above, individual nodes connecting vocabulary items are denoted with *CoP* standing for a cophonology. Thus, the sequence [[C-[D-B]]-A] has three cycles: the innermost cycle consists of VIs [D-B] subject to a cophonology *CoP-B* triggered by the outer element, the VI {B}. Taken altogether, this mapping is subject to the **CoP-scope hierarchy** whereby VIs within specifiers scope over heads, and VIs within heads scope over complements ( $\phi$  = has cophonology scope over).

(18) **CoP-scope hierarchy**

*CoP-Spec*  $\phi$  ( *CoP-Head*  $\phi$  *CoP-Complement* )

How this theory is cashed out with respect to GT is as follows. For dominant GT, the scope of grammatical tune will be the sister of the trigger in the morpho-phonological tree, and is the portion subject to Matrix-Basemap Correspondence as described above. This naturally accounts for the dominant GT asymmetry established in (6)-(7) above. Lexical heads do not impose a dominant GT pattern onto an outer affix or modifier because they are not within the cophonology scope of the lexical head. In this way, all dominance is inward, and cases of **outward dominance** would falsify this theory.

A key advantage of Cophonology Theory is that it has **intrinsic scope** built in by virtue of applying cyclically, an advantage which carries over to this model involving Matrix-Basemap Correspondence with cophonology-scope. This effectively guarantees the dominant GT asymmetry and predicts the lack of outward dominance in GT patterns. The majority of other patterns either do not make this prediction, or do so only by stipulation. These alternative models which I dismiss include Antifaithfulness via transderivational correspondence (Alderete 2001a, 2001b), Lexical MaxEnt with regularization and scaling (Gouskova & Linzen 2015), GT as tonal allomorphy (Archangeli & Pulleyblank 2015,) Colored containment with circumfixal floating tones (Trommer 2011), faithfulness to morphological class (Headmost Wins - Revithiadou 1999), and tonal strength/diacritic weight (Vaxman 2016a, Kushnir 2018). Three models have intrinsic scope and thus guarantee the dominant GT asymmetry: the one presented here, cophonology theory with markedness constraints (Inkelas 1998) and construction tonology with direct reference to c-command (McPherson 2014, McPherson & Heath 2016). I compare the strengths of each of these, and conclude that the one developed here best accounts for the fact that the trigger itself is not affected by a dominant grammatical tune.

**1.6 Structure of this study**

This study is organized into two parts. Part I presents a typology of grammatical tone split into two chapters. Chapter 2 “Grammatical tone (GT): What is it, where is it, and what is it for?” lays

out the empirical focus of this study, while chapter 3 “GT dominance effects (and beyond)” presents a complete overview of how GT exemplify dominance and show their effects in action, establishing several typological generalizations such as the dominant GT asymmetry.

Part II of this study is a theory of grammatical tone, split into three chapters. Chapter 4 “A model of the syntax/phonology interface: Design goals and design choices” present the ‘master plan’ of the syntax/phonology interface, which I use to situate the treatment of GT. Chapter 5 “Dominance as transparadigmatic uniformity via Matrix-Basemap Correspondence (MxBM-C)” supports the hypothesis of dominance transparadigmatic uniformity, formalized within MxBM-C being an extension of Output-Output Correspondence. Finally, chapter 6 “Cophonology-scope (*CoP*-scope)” lays out how the scope of grammatical tune is established at spell-out, guaranteeing the dominant GT asymmetry.

Chapter 7 provides a brief summary of the main claims, and discusses a number of areas for future inquiry.

**Part I**  
**A typology of grammatical tone**

## **Chapter 2**

**Grammatical tone (GT):  
What is it, where is it, and what is it for?**

## 2.1 What is it: The anatomy of grammatical tone

### 2.1.1 Underlying tone

The use of pitch is universal across the world’s languages, and approximately half of them use pitch in such a way that warrants classifying them as ‘tonal languages’ (Hyman 2011). Tonal languages are defined as languages ‘in which an indication of pitch enters into the lexical realization of at least some morphemes’ (Hyman 2001:1368; Hyman 2006:229). The pitch information carried by a morpheme is normally represented as a series of **tonemes** which form part of the underlying representation of a morpheme, which I abbreviate throughout as T. Tonemes are linked to a specific **tone-bearing unit (TBU)** which I will abbreviate with  $\tau$  (tau) (following Trommer 2011:53).

For example, in a language which contrasts high, mid, and low pitch, we can say there are three tonemes /H/ /M/ /L/, as in Yoruba /kɔ́/ ‘build’, /kɔ̄/ ‘sing’, and /kɔ̀/ ‘reject’. Throughout, I will refer to these tones as the **underlying tone** of a morpheme, defined as the following:

[Def 1] **Underlying tone**: the tonemes and tonemic structure inherently connected to a particular morpheme (in its underlying representation)

I do not use the term ‘lexical tone’ in order not to confuse tone associated with lexical morphemes (e.g. nouns, verbs, etc.) versus general underlying tone on morphemes.

Morphemes can have a number of distinct **tonal values**. Their TBUs can be **valued**, meaning they have a toneme T linked (pre-docked) to a TBU  $\tau$ . TBUs can also be **unvalued** meaning they do not have a linked toneme T (= ‘free TBU’ – Clements & Goldsmith 1984), or can be **mixed** and have both types. Finally, tonemes can also be **floating**, meaning that a toneme is not pre-docked to a TBU  $\tau$ . For clarity, I will designate floating tones as superscripted and circled  $\textcircled{\text{T}}$ , e.g.  $\textcircled{\text{L}}$  for a floating L toneme (I will later show that a circled but non-superscripted  $\textcircled{\text{T}}$  indicates a floating tone which has docked to a TBU). Floating tone is of course an analysis, but is an invaluable descriptive tool in understanding tone patterns and therefore is employed throughout this study.

Valued				Unvalued	Mixed		Floating		
L	HL	HL	L		H	HL	$\textcircled{\text{L}}$	$\textcircled{\text{L}}$	H $\textcircled{\text{L}}$
	∨		∧			∨			
$\tau$	$\tau$	$\tau \tau$	$\tau \tau$	$\tau$	$\tau \tau$	$\tau \tau$		$\tau$	$\tau$

Table 1: Sample of underlying tonal values

In this way, underlying tone is no different from other underlying structure (consonants, vowels, stress) and excludes non-contrastive and predictable phonological structure acquired in the course of a derivation.

In general, this work adopts the general principles of ‘Autosegmental Phonology’ (Goldsmith 1976, 1980; Clements & Goldsmith 1984) in which tonal representation is on a separate tier from other phonological content (e.g. moras, vowels, etc.). In many tone languages, tonemes are typically singleton tones /H/, /M/, and /L/ wherein surface contours can be decomposed, e.g. surface falling as underlying /H/+L/. In contrast, in the Sinitic tonosphere many contours are less readily decomposable, e.g. as underlying / $\widehat{\text{HL}}$ / (analogous to a diphthong / $\widehat{\text{ai}}$ /). This thesis will not discuss such issues, but they will be acknowledged when they are encountered and pertinent to discussion of grammatical tone. An important take-away point here is that splitting up tone into tonemes T and TBUs  $\tau$  captures the many ways tone differs quantitatively (and qualitatively) from other phonological phenomena (e.g. with respect to

toneme mobility, stability, one-to-many and many-to-one relations, underspecification, etc. – Yip 2002:65).

Further, this definition naturally includes many so-called ‘pitch accent’ systems such as Japanese (Hyman 2009). These languages are therefore also within the scope of typologizing grammatical tone. Moreover, note that tonemes often are realized phonetically as suprasegmental packages including pitch and another feature (e.g. phonation). Within this work, we will abstract away from the phonetic realization of tone and concentrate on the role it plays in grammatical systems, especially phonology, morphology, and syntax, and their interfaces.

### 2.1.2 Tonological operations

When morphemes are combined to form larger constituents to express complex meanings, a number of **tonological operations** can take place. A tonological operation refers to a case where an input shows some change in tonal structure in the output. For example, consider the table below.

	/	$m_1$	+	$m_2$	/	→	\	$m_1$	$m_2$	\	Surface	
a.		L		H		→	\	L	H	\	[L H]	No tonological operation
			+			→	\			\		
		$\tau$		$\tau$			\	$\tau$	$\tau$	\		
b.		L		H		→	\	L	H	\	[L $\overline{\text{LH}}$ ]	Horizontal assimilation
			+			→	\			\		
		$\tau$		$\tau$			\	$\tau$	$\tau$	\		
c.		$\textcircled{\text{L}}$		H		→	\	$\textcircled{\text{L}}$	H	\	$\overline{\text{LH}}$	Floating tone docking
			+			→	\			\		
				$\tau$			\	$\tau$	$\tau$	\		

Table 2: Tonological operations

In row a., the input consists of two morphemes: morpheme  $m_1$  has a docked low tone /L/ and morpheme  $m_2$  has a docked high tone /H/. When they are concatenated in context, this results in a straightforward input-to-output mapping /L H/ > \L H\ (note that backslashes \ \ are used to indicate an output, while square brackets [ ] are reserved for actual surface forms). No tonological operation takes place here as there is no change in the tonal structure from input to output.

In contrast, consider rows b.-c. which exhibit tonological operations. In row b., the input-to-output mapping is /L H/ → \L  $\overline{\text{LH}}$ \ with an allotonic rising tone (‘horizontal assimilation’ - Hyman 2007). Further, c. shows an instance of a ‘deficient input’, as summarized below:

- (1)
- a. Deficient inputs:
- i. Unvalued TBU:  $\begin{array}{|c|} \hline / \quad / \\ \hline \tau \\ \hline \end{array}$
- ii. Undocked toneme:  $\begin{array}{|c|} \hline / \quad / \\ \hline \textcircled{\text{L}} \\ \hline \end{array}$
- b. Non-deficient input: Valued TBU:  $\begin{array}{|c|} \hline / \quad \text{L} \quad / \\ \hline | \\ \hline \tau \\ \hline \end{array}$

Deficient inputs include unvalued TBUs which consist of only a TBU  $\tau$  with no toneme and undocked tonemes which consist of only a undocked toneme, i.e. a **floating tone**. When these appear in an input, various tonological operations can take place. For instance in row c. in Table

2, the floating tone docks to the only TBU available ('floating tone docking'), and thus makes a deficient input non-deficient.

Deficient inputs are nearly always subject to a tonological operation but note that this need not be the case. For example, there are languages in which unvalued TBUs are permitted as a phonological output and are only filled in post-phonologically within the phonetic implementation via 'tonal interpolation', e.g. in Tommo So [d̥t̥o] (Dogon – McPherson 2014:15), and one interpretation of Mandarin toneless morphemes, e.g. /de/ POSS (Yip 2002:71-72). Conversely, floating tones may sometimes remain floating in the output, although many languages have \*FLOAT constraints militating against this.

A working definition of a tonological operation is as follows:

[Def 2] **Tonological operation:** A phonological operation where there is a change to tonal structure in the input-to-output mapping (e.g. tone addition, deletion, replacement, shifting/displacement, assimilation, dissimilation/polarization, docking, spreading, absorption/simplification, *etc.*)

I use the term *phonological* operation here on purpose: tonological operations are part of the phonological grammar of a language, and as such are not merely the articulatory implementation of pitch targets in running speech. There is no doubt that many tonological operations have their origins in phonetic articulation and perception, but our focus here is only on those which have been fully 'phonologized' as part of the phonological grammar.

The literature on tone system typology reveals that the majority of tonal languages have tonological operations. I classify them into two major types: those which are **phonologically-conditioned** and those which are **morphologically-conditioned**.

[Def 3] **Phonologically-conditioned tonological operation:** A tonological operation conditioned by a particular phonological context (or natural class of phonological contexts)

[Def 4] **Morphologically-conditioned tonological operation:** A tonological operation conditioned by a particular morpheme (or natural class of morphemes), or morpho-syntactic construction (or natural class of constructions)

Throughout, I make no strict/formal distinction between syntax and morphology and use the term 'morphologically' as neutrally as possible.

### 2.1.3 *Defining grammatical tone*

#### 2.1.3.1 What is it?

In tonal languages, tone is consistently found to function in the marking of grammatical categories and grammatical relations<sup>1</sup>. I collectively refer to such tonological operations as **grammatical tone (GT)**, which I define as the following:

---

<sup>1</sup> I use the term 'grammatical' somewhat as a proxy for morphological/morphosyntactic grammar, and its interface with form and meaning. The use of 'grammatical' does not refer to phonological constituents such as those marked by boundary tones, though these are unquestionably part of a language's grammar. The use of 'grammatical' in the term 'grammatical tone' has never been used to refer to *phonological* grammar to my knowledge, and as such this convention has pre-existing currency.



[Def 5] **Grammatical tone (GT):** a tonological operation which is not general across the phonological grammar, and is restricted to the context of a specific morpheme or construction, or a natural class of morphemes or constructions (i.e. grammatically conditioned tone addition, deletion, replacement, shifting, assimilation, dissimilation, *etc.*)

A more technical definition is below.

(2)

- a. **Given** a construction  $C_1$  consisting of  $\{x, y\}$ , where  $\{x\}$  and  $\{y\}$  are
  - i. a grammatically natural class of morphemes  $\{m_1, m_2\}$  or
  - ii. a grammatically natural class of constructions  $\{C_2, C_3\}$
- b. **If** there is a change in the tonal value of one of  $\{x\}$  or  $\{y\}$  in an output  $\backslash x^T y^T \backslash$  compared to the values in inputs  $/ x^T /$  and  $/ y^T /$
- c. **And** constructions  $\neg C_1$  do not condition this change in the tonal value
- d. **Then** the tonal operation can be called **grammatical tone**

All tonological operations have the potential to be grammatical tone, as long as they are restricted to a particular grammatical context and not phonologically general throughout the grammar. A schematized sample of GT operations is below. The different morphemes are highlighted in different colors for clarity.

Grammatical construction $C_1$						Output	GT operation
/	$m_1$	+	$m_2$	/ $\rightarrow$ \	$m_1 m_2$		
a.	$\textcircled{L}$		$H$	$\rightarrow$	$\textcircled{L}H$	$\boxed{L}H$	Floating tone docking 1
b.	$M^{\textcircled{L}}$		$H$	$\rightarrow$	$M \textcircled{L}H$	$M \boxed{L}H$	Floating tone docking 2
c.	$M$		$H$	$\rightarrow$	$M$	$M \emptyset$	Deletion
d.	$M$		$H$	$\rightarrow$	$M \textcircled{L} \textcircled{M}$	$M \boxed{LM}$	Replacement
e.	$M$		$H$	$\rightarrow$	$M H$	$M \emptyset H$	Shifting
f.	$L$		$L$	$\rightarrow$	$L H$	$L \boxed{H}$	Dissimilation
g.	$L$		$\tau$	$\rightarrow$	$L H$	$L \boxed{H}$	Polarization
h.	$H L$		$L$	$\rightarrow$	$H L$	$\boxed{H} L$	Absorption
i.	$L$		$H$	$\rightarrow$	$L H$	$L \boxed{L}H$	Horizontal assimilation
j.	$L$		$H$	$\rightarrow$	$L M$	$L \boxed{M}$	Vertical assimilation
k.	$H$		$\tau$	$\rightarrow$	$H$	$H \boxed{H}$	Tone spreading

Table 3: Possible grammatically conditioned tonological operations

In this way, grammatical tone is a special type of morphologically-conditioned tonological operation, and in fact constitutes the fact majority of such cases. In section 2.2.1, I will show examples of morphologically-conditioned operations which are *not* technically grammatical tone because they involve floating tones on lexical items, e.g. a noun with floating  $\textcircled{L}$  after it.

Grammatical tone can express all types of grammatical meaning, and as such functions to manipulate the lexical meaning expressed by core lexical categories nouns and verbs. This includes nominal grammatical categories (definiteness, specificity, demonstratives, numerals, quantification, plurality, classification, case, etc.) as well as verbal ones (auxiliaries, tense, aspect, mood, agreement, etc.), and the various other inflectional and derivational categories. Relatedly, grammatical tone can signal grammatical relations which are not necessarily marked with a segmental morpheme, e.g. [OBJECT + VERB] construction in a transitive clause, a [POSSESSOR + POSSESSED] construction in a genitive clause, a [DEMONSTRATIVE + NOUN] clause,

among others. In many of these cases, the only phonological signal to the construction (other than linear order) is grammatical tone.

The majority of cases in this study involve GT interpreted as ‘tonal morphemes’, where a specific tonal pattern co-varies with a meaning consisting across contexts. Consider two types of ‘tonal morphemes’: **replacive tone** and **floating tone**. Two examples of replacive tone are from Jumjum [jum] (Andersen 2004:161, Trommer 2011:13) and Kalabari [ijn] (Harry & Hyman 2014). The Jumjum data are in (3)-(4).

(3)	Jumjum replacive tone: L-replacement in modified nouns				
	Underlying	Absolutive	Modified	Surface	Meaning
a.	/H/	ḡé:ŋ	<b>ḡé:ŋ</b>	[L]	‘cow’
b.	/L/	kù:n	<b>kù:n</b>	[L]	‘thorn.SG’
c.	/HL/	cìcàm	<b>cìcàm</b>	[LL]	‘knife’
d.	/LH/	càw-ná	<b>càw-nà</b>	[LL]	‘arrow-SG’
(4)	/bòròŋ-gó cloth-PL	?ḡon / man.SG	→	[bòròŋ-gò ?ḡon ] ‘the man’s clothes’	

[Jumjum – Andersen 2004:161]

In Jumjum, nouns have underlying tone shown at the left in (3), i.e. /H/, /HL/, /L/, /LH/. When the noun is modified in various contexts, the underlying tones of the noun are replaced by an all [L] pattern, e.g. /cìcàm/ → \cìcàm\ ‘knife’, which Anderson says expresses the ‘antigenitive case’. This constitutes GT as it involves a tonological operation mapping an input tone to an output low \L\, and it is restricted to a natural class of grammatical contexts, i.e. modified noun contexts. Example (4) shows that this tonal replacement is not restricted to a single morpheme, but targets all elements within the relevant domain such as a plural suffix.

The Kalabari case shows replacive tone consisting of more than a simple L.

(5)	Replacive tone		/ mí / ‘this’ (neut.)	/ mí <sup>+</sup> ná / ‘these’
			[H LH]	[H <sup>+</sup> H LH]
a.	HH	/ námá / ‘meat’	[mí <b>námá</b> ]	[mí <sup>+</sup> ná <b>námá</b> ]
b.	LL	/ pùlò / ‘oil’	[mí <b>pùlò</b> ]	[mí <sup>+</sup> ná <b>pùlò</b> ]
c.	HL	/ bélé / ‘light’	[mí <b>bélé</b> ]	[mí <sup>+</sup> ná <b>bélé</b> ]
d.	LH	/ gàrí / ‘garri (food)’	[mí <b>gàrí</b> ]	[mí <sup>+</sup> ná <b>gàrí</b> ]
e.	H <sup>+</sup> H	/ bá <sup>+</sup> rá / ‘hand’	[mí <b>bàrá</b> ]	[mí <sup>+</sup> ná <b>bàrá</b> ]

[Kalabari - Harry & Hyman 2014:6]

As in Jumjum, nouns contrast for underlying tone values shown at the left. When they appear with demonstratives (e.g. *mí* ‘this’), these underlying tones are replaced by a LH melody. Harry & Hyman show that modifiers idiosyncratically assign a replacive tone by class, e.g. possessive pronouns assign a H<sup>+</sup>H~HLH while quantifiers assign an all L replacive tone.

In contrast, what are often called ‘floating tones’ in the literature (or ‘concatenative’ tone) do not involve this kind of replacement. Kalabari also illustrates this type with floating <sup>Ⓣ</sup>Ⓛ which expresses IMPERATIVE.

(6)	Non-dominant GT		/ <u>  </u> + <sup>⊕</sup> ⊕ / IMPERATIVE	
a.	/H/	/ só /	‘go’	\ sô \ ‘go!’
		/ bó /	‘come’	\ bô \ ‘come!’
		/ mú /	‘go’	\ mû \ ‘go!’
b.	/L/	/ sò /	‘cook’	\ sô \ ‘cook!’
		/ bè /	‘say’	\ bē \ ‘say (it)’
		/ tù /	‘set’	\ tû \ ‘set (a trap)’
c.	/HH/	/ ólò /	‘cough’	\ ólô \ ‘cough!’
		/ sá bá /	‘cross’	\ sá bā \ ‘cross!’ (= [sáwâ])
		/ kú ró /	‘fall’	\ kú rō \ ‘fall!’
d.	/LL/	/ lè gí /	‘sit down’	\ lè gî \ ‘sit down!’
		/ pì rì /	‘give’	\ pì rî \ ‘give (it)’
e.	<sup>x</sup> /HL/	-	-	-
f.	/LH/	/ ðù kó /	‘tell, talk’	\ ðù kô \ ‘tell (it)’
		/ sà kí /	‘get up’	\ sà kî \ ‘get up!’
g.	/H <sup>+</sup> H/	/ s’lò /	‘hold’	\ s’lô \ ‘hold (it)’

[Kalabari – author fieldnotes]

Like nouns, verbs in Kalabari also contrast for underlying tone values shown at the left (note that there are no /HL/ verbs in row e. – Harry 2004:98). Every form of the verb in the imperative ends in a HL falling tone on the final TBU, illustrating the effect of the floating tone sequence. But unlike with the demonstratives in (5) above, the imperative does not replace the entire tone sequence and rather co-occurs with it. Lexical contrast is maintained, e.g. the minimal pair \ólô\ ‘cough!’ in (6)c. versus \s’lô\ ‘hold (it)’ in (6)g. Lexical contrast maintenance, in fact, creates super marked structures such as three tonemes docking to a single TBU, e.g. L-toned /sò/ ‘cook’ → \sô\ ‘cook!’ in (6)b (with subsequent lengthening in the surface form to accommodate).

Replacive tone and floating tone represent two ends of a single cline. Some cases of GT only partially replace underlying tones, often subject to markedness and other phonological restrictions. Consider the Igbo dialectal data below [[igbo1259](#)] (Hyman & Schuh 1974:98-99; Hyman 2011).

- (7)
- |    |               |                                |   |                            |                 |
|----|---------------|--------------------------------|---|----------------------------|-----------------|
| a. | Central Igbo: | / àgbà + <sup>⊕</sup> + èṅwè / | → | \ àgbà <sup>⊕</sup> èṅwè \ | ‘jaw of monkey’ |
| b. | Aboh Igbo:    | / ègbà + <sup>⊕</sup> + èṅwè / | → | \ ègbà <sup>⊕</sup> èṅwè \ | ‘jaw of monkey’ |

Here, two nouns in an associative construction are linked via a tonal morpheme, below represented as a floating tone <sup>⊕</sup> between the nouns. This links to an underlying all-/L/ noun /àgbà~/ègbà/ ‘jaw’ or /èṅwè/ ‘monkey’, but only replaces one of the /L/ tones, not both. Hyman & Schuh point out that it docks to the left in Central Igbo, but to the right in Aboh Igbo.

Replacing a single toneme can be local or non-local, shown in San Miguel el Grande Mixtec [[mig](#)] (data from Mak 1950 and McKendry 2013, theorized in Zimmermann 2016 where this data was taken from).

- (8)
- |    |               |  |   |                |
|----|---------------|--|---|----------------|
| a. | MM            |  | → | <sup>⊕</sup> M |
|    | / kābè bīkō / |  |   | kābè bīkō      |
|    | day fiesta    |  |   | ‘fiesta day’   |

- b.            LH  
 /k<sup>w</sup>āʔà sùtʃí /            →    k<sup>w</sup>āʔà sùtʃí  
 many children                ‘many children’  
 [San Miguel el Grande Mixtec – Zimmermann 2016:274]

San Miguel el Grande Mixtec has a ‘perturbation’ effect wherein words appear with H tone not present in the underlying form. Example (8) shows that this H tone replaces only the initial M and L tonemes of the second word in the phrase, a single toneme. The effect of this H tone perturbation for all possible two-TBU inputs is below (note that there are no / LL / forms).

- (9)            Underlying    Perturbed output
- a.    \* / LL /
  - b.    / LM /            \ **H**M \
  - c.    / LH /            \ **H**H \
  - d.    / ML /            \ **H**L \    if (C)CVʔ(C)V or CV<sub>1</sub>:
  - \ **M****H** \    if (C)CVCV or CV<sub>1</sub>V<sub>2</sub>
  - e.    / MM /            \ **H**M \
  - f.    / MH /            \ MH \
  - g.    / HL /            \ HL \
  - h.    / HM /            \ HM \
  - i.    / HH /            \ HH \

[San Miguel el Grande Mixtec – Zimmermann 2016:275]

In rows b.-e. the H tone replaces a single toneme, whereas in f.-i. the H tone does not replace one (or if it does, it replaces an underlying /H/ and is thus vacuous replacement). Importantly in row d., the H tone does not replace the initial TBU if the input is /ML/ with a specific segmental profile, but replaces the non-local TBU resulting in \M**H**\. Regardless of analysis, in all of these cases at most only a single toneme is replaced.

We can therefore place floating tone and replacive tone on a single cline, shown in Figure 1 below.

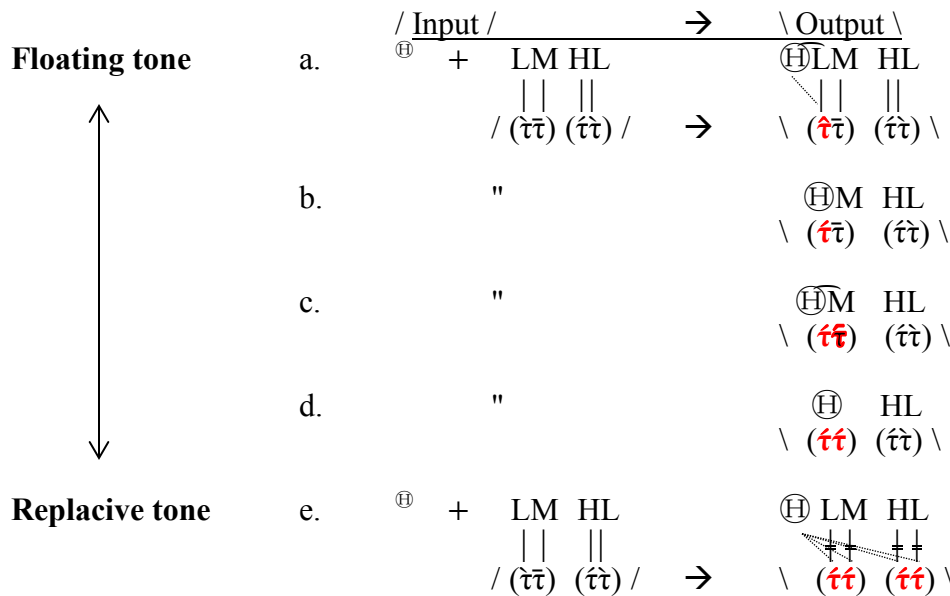

Figure 1: Cline between floating tone and replacive tone

At one end is a typical situation with a floating tone where it docks to a single TBU and does not replace any toneme. This is shown in row a. in this figure, where the input involves a floating tone <sup>Ⓣ</sup> plus a two word unit in parentheses with underlying tone. The floating tone docks to the initial TBU of the first word, resulting in a falling contour **↘** (where it docks is shown in red and bold in the output). At the other end is ‘replacive tone’ which replaces all tonemes within the relevant domain, often over several words/morphemes. This is shown in row e., where H tone replaces all underlying tones from the input, resulting in an all high output over both words. Between these two end points is replacing only a portion of the input, whether the first TBU (row b.), the first TBU plus spreading onto the second (c.), or replacing all TBUs of the first word but not the second (d.). Such cases are attested, as will be seen throughout this study. Replacive tone is represented as floating tone in the diagram above, but other conceptions are possible and indeed advocated for (e.g. McPherson 2014 derives them through construction constraints).

For the purposes of this typology, I will treat *all* instances of replacement tone and floating tone as constituting grammatical tone. This is slightly at odds with the definition of GT in [Def 5] in which GT was defined as a tonological operation restricted to a particular grammatical context. In the Jumjum and Igbo cases, although the [L] and [H] tonemes are straightforwardly linked to the construction, the actual replacement/addition/docking/spreading operation might be seen as phonologically general and therefore not restricted to this context. In many cases, this boils down to whether one derives the patterns via a floating tone analysis, or via an alternative operation. To avoid this complication, I treat all such cases uniformly as GT.

Note that this definition does not say that grammatical tone is necessarily the *realization* (i.e. exponence) of a specific grammatical category itself, although it may be. From these Jumjum data alone, it is equally plausible to say that the toneme L is the realization of a grammatical category [MODIFIER], or to say that a tonological process of L-replacement takes place in this grammatical context. The difference amounts to saying that there is an exponence rule akin to MODIFIER ↔ /L/, or that L tone is merely licensed in modificational contexts but comes in for different reasons. In order to avoid deciding this for each GT token, I retain the broadest definition which encompasses both interpretations. I will discuss GT as exponence further in section 2.2.3 below.

Finally, having the definition of grammatical tone formulated in [Def 5] above allows us to have a single criterion for typologizing over grammatical tone patterns, which have different names depending on the analyst, phenomenon, and linguistic tradition. A sample of such names is provided below.

Name	Notes	Source
tonal morpheme	Co-occurs with no segments	[Welmers 1969, 1973; Yip 2002:106]
tonal affix/affixal tone		[Yip 2002:115]
tonal particle		[Yip 2002:114]
tonal suprafix		[Remijsen 2010: 289-290]
inflectional tone		[Palancar & Léonard 2016]
replacive tone	Africanist Literature	[Welmers 1973:132-133]
meaningful tone	Hmong literature	[Ratliff 2010]
morphological tone		[Zimmermann 2016]
morphosyntactic tone		[Palancar 2016:113]
melodic tone	Bantu	[Odden & Bickmore 2014]
floating tone		[Voorhoeve 1971; Hyman & Tadadjeu 1976]
tonal overlay		[McPherson & Heath 2016]
grammatical use of tone		[Ladefoged & Johnson 2011]

Name	Notes	Source
morphological use of tone		[Gussenhoven 2004:46]
syntactic use of tone		[Gussenhoven 2004:46]
tonosyntax		[Heath & McPherson 2013]
construction tonology		[Harry & Hyman 2014]
phrasal grammatical tone		[McPherson & Heath 2016]
melody replacement		[Rodewald 1989]
construction-specific tonology		[Yip 2002:107]
compacité tonale	Mande literature	[Green 2018]
tone perturbation	Americanist Tradition	[Pike 1948:25; Mak 1950]
tone change	Chinese: <i>bianyin</i> (cf. tone sandhi, <i>biandiao</i> )	[Chen 2000:30-31]
semantic-tonal process	SE/East Asian	[Kam 1980]

Table 4: Names for tonal phenomena associated with ‘grammatical tone’

### 2.1.3.2 What is it *not*?

GT should not merely be considered the presence of underlying tone on a morpheme; some type of tonological operation must be present. In Standard Yoruba [yɔɾ] (Akinlabi & Liberman 2000), possessive pronouns have inherent underlying tone: the grammatical marker /iɾɛ/~Vɾɛ/ 2SG.POSS ‘your’ has underlying /LM/ tone while the segmentally identical /iɾɛ/~Vɾɛ/ 3SG.POSS ‘his/her’ has /ML/ tone. The possessive pronoun paradigm is below, with the most relevant data being in rows b. and c. In this case, no tonological operation takes place because there is no change to the tonal structure in the input-to-output mapping.<sup>2</sup>

#### (10) *Not* grammatical tone - Yoruba possessive pronouns (non-clitic forms)

	/ ɔkò / ‘car’	/ ɔkó / ‘hoe’	/ ɔkɔ́ / ‘husband’
a. / Vmī / ‘my’	\ ɔkò òmī \	\ ɔkó òmī \	\ ɔkɔ́ òmī \
b. / Vɾɛ / ‘your’	\ ɔkò <u>ɔrɛ</u> \	\ ɔkó <u>ɔrɛ</u> \	\ ɔkɔ́ <u>ɔrɛ</u> \
c. / Vɾɛ / ‘his/her’	\ ɔkò <u>ɔrɛ</u> \	\ ɔkó <u>ɔrɛ</u> \	\ ɔkɔ́ <u>ɔrɛ</u> \
d. / Vwā / ‘our’	\ ɔkò ɔwā \	\ ɔkó ɔwā \	\ ɔkɔ́ ɔwā \
e. / Vyí / ‘your’ (pl.)	\ ɔkò ɔyí \	\ ɔkó ɔyí \	\ ɔkɔ́ ɔyí \
f. / Vwɔ́ / ‘their’	\ ɔkò ɔwɔ́ \	\ ɔkó ɔwɔ́ \	\ ɔkɔ́ ɔwɔ́ \

[Akinlabi & Liberman 2000]

For these data, one cannot decompose the tonemes into a separate exponent, i.e. 2<sup>nd</sup> ↔ /LM/ and 3<sup>rd</sup> ↔ /ML/, given the differences in the plural forms. Parallel facts are seen in the San Ildefonso Tultepec dialect of Northern Otomi [otq] (Palancar 2016:113) where grammatical clitics can be distinguished by their underlying tone, e.g. minimal pair /dá=/ 1.CPL (completive) vs. /dà=/ 3.IRR (irrealis). Therefore, even though these examples involve a grammatical contrast involving tone (e.g. person, aspect, etc.), these cases do not meet the definition of grammatical tone.

Grammatical tone also is not **tonal allomorphy**. I define tonal allomorphy as the following, centered around the notion of productivity:

#### [Def 6] **Tonal allomorphy:**

- A morpheme has two or more underlying allomorphs
- The allomorphs have distinct tonal shapes but identical segmental shapes

<sup>2</sup> Note that this last statement applies only to the non-cliticized form of possessive pronouns.

- c. The tonal allomorphs are found in complementary distribution conditioned by some linguistic element in its environment
- d. Other morphemes which appear in this environment do not show tonal allomorphy (i.e. the alternation is not productive)

As an example of tonal allomorphy, consider the so called ‘*yi-bu-qi-ba* rule’ in Standard Mandarin Chinese (Chang 1992:166-170; Chen 2000:22; Wang 2014; Yang 2015:14). Simplifying for our purposes, this rule applies only to four morphemes, namely *yī* /T1~55~H/ ‘one’, *bù* /T4~51~HL/ ‘not’, *qī* /T1~55~H/ ‘seven’, and *bā* /T1~55~H/ ‘eight’. This rule obligatorily changes these morphemes into surface shape [35] when followed by a surface [53] TBU. Chen points to the following minimal pair with *bù* ‘not’ in (11)a. versus *bù* ‘division, unit’ in (b.), showing that this tonological process does not apply regularly.

- (11) Tonal allomorphy in Mandarin Chinese with the *yi-bu-qi-ba* rule
- a.  $\begin{matrix} \boxed{bù} & duì & \text{‘not correct’} & <\text{不对}> \\ \boxed{[35]} & 53 & & \end{matrix}$
  - b.  $\begin{matrix} b\grave{u} & duì & \text{‘troops’} & <\text{部队}> \\ [53] & 53 & & \end{matrix}$

For these data, we can posit multiple tonal allomorphs for these morphemes, allomorphy not found for other morphemes, i.e. a morpheme *bù* with two tonal allomorphs /bu<sup>51</sup>/ (elsewhere) and /bu<sup>35</sup>/ (/\_\_ 53). As such, this does not constitute a tonological rule or process, but rather selection akin to common segmental allomorphy such as English *sleep* with allomorphs /slep/ in the context of /-t/ PAST, and /slip/ elsewhere. In short, tonal allomorphy involves segmental and tonal units which enter the input as a single bundle, i.e. /bu<sup>35</sup>/, whereas grammatical tone involves cases when the segmental and tonal structure enters the input separately, i.e. /cìcàm/ + /<sup>Ⓛ</sup>/ (→\cìcàm\ ) in the Jumjum case in (3).<sup>3</sup>

Further, I also consider grammatical tone to be distinct from **tone sandhi**, defined as the following:<sup>4</sup>

[Def 7] **Tone sandhi:**

- a. For a sequence of tonemes /T1 T2/ (often restricted to a specific phonological domain *D*)
- b. There are a set of tonal alternations in the mapping of /T1/→\T1\ and/or /T2/→\T2\
- c. Which are not conditioned by a grammatical property of either /T1/, /T2/, or the construction which /T1 T2/ forms

<sup>3</sup> There are several attempts to reduce *all* tonal alternations (and morphophonemic alternations generally) to allomorphy regardless of predictability and productivity, e.g. Archangeli & Pulleyblank (2015) and Angheliescu et al. (2017) for tone, as well as Green (2006) for consonant mutation (discussed in McPherson 2014:48-50). I will not consider this approach here, if only for the fact that it is too radical a departure from this study to provide any succinct criticism. I return to these models at the end of chapter 6.

<sup>4</sup> Other attempts to define tone sandhi can be vague, e.g. Chen’s (2000:19) definition of it as a process which ‘alter[s] the phonetic shape of adjacent tones, when they come into contact with each other in connected speech’. His definition reflects the fact that he sees no essential difference between TS (by hypothesis a phonological operation part of the phonological grammar) and tonal coarticulation (articulatory implementation of a motor plan fed from the phonological module) (Chen 2000:27).



- d. But rather, is triggered by the underlying tonological value of /T1/ and/or /T2/, or from being in a specific phonological position (e.g. non-final or non-initial within a domain)
- e. And therefore the alternation is phonologically general

A famous example of tone sandhi which meets this definition is Beijing Mandarin ‘third tone sandhi’. Mandarin has four tonemes (where 5 = highest pitch): T1 /5/ (/ma<sup>55</sup>/ ‘mother’), T2 /35/ (/ma<sup>35</sup>/ ‘hemp’), T3 /214/ (/ma<sup>214</sup>/ ‘horse’), and T4 /51/ (/ma<sup>51</sup>/ ‘to scold’). The third tone T3 /214/ dissimilates to T2 /35/ when it precedes another T3 /214/, shown in (12) below. This tone change is conditioned by the underlying tonological value of the second unit and is not triggered by grammatical context (contexts which are diverse, e.g. [ADJ N], [N ADJ], [V OBJ], etc.).

- (12) Tone sandhi in Chinese
- |    |  |   |   |
|----|--|---|---|
| a. | / T3 T3 /                                  | → | \ <span style="border: 1px solid black; padding: 0 2px;">T2</span> T3 \ |
|    | / τ <sup>214</sup> τ <sup>214</sup> /      | → | \ τ <sup>35</sup> τ <sup>214</sup> \                                    |
| b. | / xiao <sup>214</sup> gou <sup>214</sup> / | → | \ xiao <sup>35</sup> gou <sup>214</sup> \                               |
|    | small dog                                  |   | ‘small dog, puppy’  |
| c. | / dan <sup>214</sup> xiao <sup>214</sup> / | → | \ dan <sup>35</sup> xiao <sup>214</sup> \                               |
|    | gall small                                 |   | ‘coward’  |
| d. | / mai <sup>214</sup> ma <sup>214</sup> /   | → | \ mai <sup>35</sup> ma <sup>214</sup> \                                 |
|    | buy horse                                  |   | ‘to buy a horse’  |

*[Beijing Mandarin - Chen 2000:20-21]*

We will return to cases of **grammatical tone sandhi** in chapter 3, which are like tone sandhi in being triggered by the underlying tonological value of a toneme, but are like grammatical tone in that they only occur in a highly restricted set of grammatical contexts. At this point, we should merely understand that tone sandhi and grammatical tone are distinct phenomena.

The final two prosodic phenomena which I distinguish from grammatical tone are **boundary tones** and **intonation**. Boundary tones demarcate prosodic constituents, and are phonologically licensed and not limited to particular grammatical contexts. A definition of boundary tones is below:

[Def 8] **Boundary tone:** A toneme which is inserted at the edge of a phonological constituent  
 e.g. / (ϕ τ ... τ) / > \ (ϕ τ ... τ) \

Further, intonation is like GT in that it involves isolatable prosodic units which can be associated with specific meaning, albeit expressing sentence-level meanings (e.g. declarative vs. interrogative). We may call the units of contrast ‘intonemes’ to distinguish them from ‘tonemes’ in GT. A definition adapted from Ladd (2008) and an example from Gibbon (1998) is below.

[Def 9] **Intonational tone (Intoneme):** prosodic units of contrast which express sentence-level pragmatic meaning (definition adapted from Ladd 2008)  
 e.g. H-H% <-> INTERROGATIVE (German – Gibbon 1998:82)

The relationship between intonation and grammatical tone requires a study onto itself and I will not comment on it further.

### 2.1.4 GT components

In this section, I lay out the terminology used in describing the components of grammatical tone. To illustrate these components, I will first use a grammatical tone pattern found in Kalabari introduced above, in which a demonstrative assigns a [LH] pattern to a noun and neutralizes its underlying tones (part of a network of GT patterns in the language). The tone change here is from /TT/>\LH\, and is not phonologically general. [Note <sup>+</sup>H is a downstepped H]

(13) Kalabari demonstrative GT

		/ mí / ‘this’ (neut.)	/ mí <sup>+</sup> ná / ‘these’
a.	HH	/ námá / ‘meat’	\ mí <sup>+</sup> ná námá \
b.	LL	/ pùlò / ‘oil’	\ mí <sup>+</sup> ná pùlò \
c.	HL	/ bélé / ‘light’	\ mí <sup>+</sup> ná bélé \
d.	LH	/ gàrí / ‘garri (food)’	\ mí <sup>+</sup> ná gàrí \
e.	H <sup>+</sup> H	/ òá <sup>+</sup> rá / ‘hand’	\ mí <sup>+</sup> ná òá <sup>+</sup> rá \
		\ H LH \	\ H <sup>+</sup> H LH \

[Harry & Hyman 2014:6]

The figure below deconstructs the input-to-output mapping in (13)c.

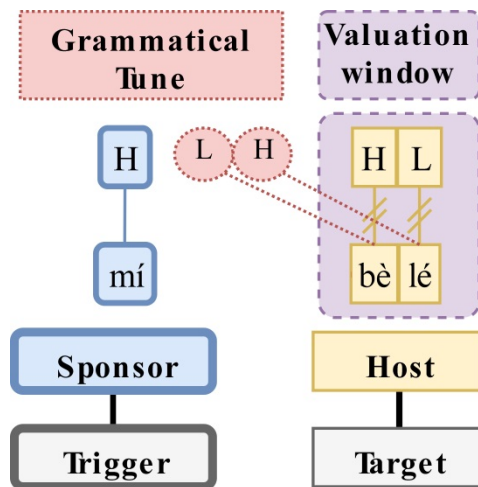

Figure 2: Full components of grammatical tone

The first component is the **grammatical tone** (or GT tone). In this case, the grammatical tone is the [LH] pattern which appears on the noun. I define it as the following:

[Def 10] **Grammatical tone**: the unique tone sequence (or set of tone sequences) which covaries with the grammatical tone construction

In the cases presented in the previous section, we can refer to the surface [L] pattern in Jumjum (3) and the docked [H] toneme in Igbo (7) as the grammatical tone. In many cases, the grammatical tone will be the same as the underlying tone value of the sponsor, in which case the most straightforward analysis is tone spreading.

Two other components are the **sponsor** and the **host** (which can be further specified as GT sponsor and GT host).

[Def 11] **Sponsor**: the morpheme (or natural class of morphemes) which covaries with the grammatical tune

[Def 12] **Host**: the morpheme or morphemes on which the grammatical tune appears

In the Kalabari example, the sponsor is the demonstrative /mí/ which covaries with the [LH] grammatical tune and the host is the noun /bélè/ ‘light’ on which the [LH] tune appears, i.e. [bèlé]. In such cases, the grammatical tune can be said to originate from the sponsor, and as such it can be thought of as part of the underlying tonal structure of this morpheme, e.g. as /mí<sup>ⓁⓈ</sup>/ with a pre-linked /H/ tone and a floating tone sequence.

We also need to define two related components, the **trigger** and the **target** (or GT trigger and GT target), common roles in (morpho)phonological operations.

[Def 13] **Trigger**: the morpheme or construction which licenses the tonological operation

[Def 14] **Target**: the morpheme or morphemes which is the intended undergoer of a tonological operation

In most instances of GT, the trigger will be coextensive with the sponsor and the target with the host. In the Kalabari case, the trigger of the GT pattern can be said to be the demonstrative and the target can be said to be the noun. When this is the case, I refer to the relevant morpheme(s) as the **trigger-sponsor** and **target-host** respectively. In others case it may be useful to make the distinction (see immediately below).

Finally, the portion of the target-host which is relevant for the grammatical tune docking is the **valuation window**:

[Def 15] **Valuation window**: the portion of the target-host which is evaluated with respect to whether its TBUs are valued or unvalued; this can be coextensive with the target-host, or strictly a local subconstituent

In the Kalabari case, the valuation window was the entire target-host (the entirety of which was subject to tone replacement). Next in chapter 3 on dominance effects, we will see different sized valuations windows.

The concepts of ‘trigger’ and ‘sponsor’ are very similar, as are ‘target’ and ‘host’. I distinguish them for a number of reasons. First, the terms sponsor and host are neutral in the sense that one can reasonably infer them from the surface pattern of the language. In contrast, classifying the ‘trigger’ and ‘target’ largely constitute analytic decisions. For example, one could say that the demonstrative morpheme itself is the GT trigger, or that the construction [DEM N] is the trigger. This ambiguity is compounded by the fact that all demonstratives license this tonological operation, but no other nominal modifiers do so. This type of ambiguity is often found with constructions without overt segmental material signaling the construction. For example, in the Igbo cases above, the associative construction can be schematized as [N<sub>1</sub><sup>Ⓢ</sup> N<sub>2</sub>]. One might say that the associative *construction* itself is the trigger and licenses a high tone. Alternatively, one says that there is an abstract associative *morpheme* which occurs between the nouns and is segmentally null.

In many such cases, the sponsor and trigger can be differentiated. Consider associative constructions in Nkoroo [nkx] (Akinlabi, Connell, & Obikudo 2009). Here, the first noun of the [N<sub>1</sub> N<sub>2</sub>] construction surfaces with its underlying tones, but the second noun bears a pattern determined by the final toneme of N<sub>1</sub>.

- (14)
- |    |           |           |                               |
|----|-----------|-----------|-------------------------------|
|    |           |           | / + t̀k̀ú / ‘child’           |
| a. | / ánáná / | ‘sheep’   | ánáná t̀k̀ù ‘lamb’            |
| b. | / wáři /  | ‘house’   | wáři t̀k̀ù ‘domestic servant’ |
| c. | / òòk̀ò / | ‘chicken’ | òòk̀ò t̀k̀ù ‘chick’           |

[Nkoroo - Akinlabi, Connell, & Obikudo 2009]

If the final T of N<sub>1</sub> ends in /H/, N<sub>2</sub> bears a [HL] pattern; if it ends in /L/ it bears an all [L] pattern. This is schematized below.

N <sub>2</sub> \ N <sub>1</sub>	HH	LL	HL	H <sup>+</sup> H	LH
HH	HH HL	HH HL	HH HL	HH HL	HH HL
LL	LL LL	LL LL	LL LL		LL LL
HL	HL LL	HL LL	HL LL		HL LL
H <sup>+</sup> H					
LH					

Table 5: Nkoroo [N<sub>1</sub> N<sub>2</sub>] constructions (Grey cells = No data available)

In this case, one can say that there are two grammatical tunes in complementary distribution. One of these surface ‘allotunes’ [HL] covaries with nouns ending in /H/ while another [LL] covaries with nouns ending in /L/. We can therefore reasonably state that the N<sub>1</sub> is the sponsor of the grammatical tune. However, the trigger of the grammatical tone as a whole is not the first noun, but rather the associative construction itself, or equivalently a segmentally null associative morpheme. Here, the sponsor (N<sub>1</sub>) and the trigger (an abstract associative morpheme) are not the same. Note that in many cases, one may devise alternatives to conflate the trigger and sponsor together; I maintain that such a move should be done on a case-by-case basis.

Similarly, the target endows the grammar with intention and is therefore an analytic decision, as opposed to host which is sufficiently neutral. Moreover, there are several cases where the host and target differentiate. First, in many cases a morpheme is an unsuitable host for a grammatical tune. A common reason is that docking the grammatical tune to the host would result in a marked structure banned in the grammar (although we will actually see in chapter 3 that interactions of markedness and grammatical tone are surprisingly limited). In Giphende [pem] (Hyman 2017:113-114), there are several types of grammatical <sup>Ⓟ</sup> tones which dock to the left-edge of a noun, each showing different behavior and expressing different meanings. One type of grammatical tone I call <sup>Ⓟ</sup><sub>1</sub> marks a focused object, and only docks to the left edge if no /H/ tone already exists on the noun. As shown in (15), <sup>Ⓟ</sup><sub>1</sub> + L-LL/ outputs as \Ⓟ-ⓅL\ with a docked <sup>Ⓟ</sup>. In contrast, it does not dock to nouns with underlying /L-LH/, /L-HL/, or /L-HH/.

- (15)
- |                               |          |          |          |
|-------------------------------|----------|----------|----------|
| / L-LL /                      | / L-LH / | / L-HL / | / L-HH / |
| / <sup>Ⓟ</sup> <sub>1</sub> / | Ⓟ-ⓅL     | L-LH     | L-HL     |
|                               |          | (*Ⓟ-LH)  | (*Ⓟ-HL)  |
|                               |          | (*Ⓟ-ⓅH)  | (*Ⓟ-HH)  |

In all four cases, the target of the grammatical tune is the noun. However, the only one in which there is an actual host of the grammatical tune are /L-LL/ inputs.

In other cases, there is evidence that one morpheme (or set of morphemes) is the target but the actual host is another morpheme (or set). In Tommo So [dto] (Dogon – McPherson & Heath 2016), many nominal modifiers are triggers of grammatical tone (their term is ‘controllers’), assigning a grammatical tune to a target. For example, the post-nominal demonstrative *nó* ‘this’

assigns /L/ tone, shown in (16). I adopt the representation /<sup>Ⓛ</sup>nó/, but note that they do not adopt this representation. This targets any morpheme within its scope, which results in the grammatical tune L hosted on the noun in (a) and the [NOUN ADJECTIVE] construction in (b).

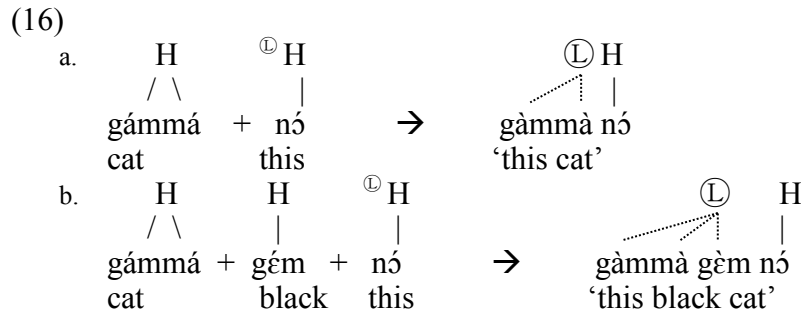

In contrast are the data in (17) which are in free variation. These examples involve an alienable possessor /m̄m̄ɔ/ 1SG.POSS, which the grammatical tune cannot affect. This results in either the head noun hosting the <sup>Ⓛ</sup> tune while the possessor retains its underlying tones (ex. a), or the tune falling on the sponsor-trigger demonstrative *nó* itself (ex. b), in which case both the noun and the possessor retain underlying tones. McPherson & Heath refer to this latter situation as ‘self-control’, a topic we will return to in Chapter 3 (there it is called ‘self-docking’).

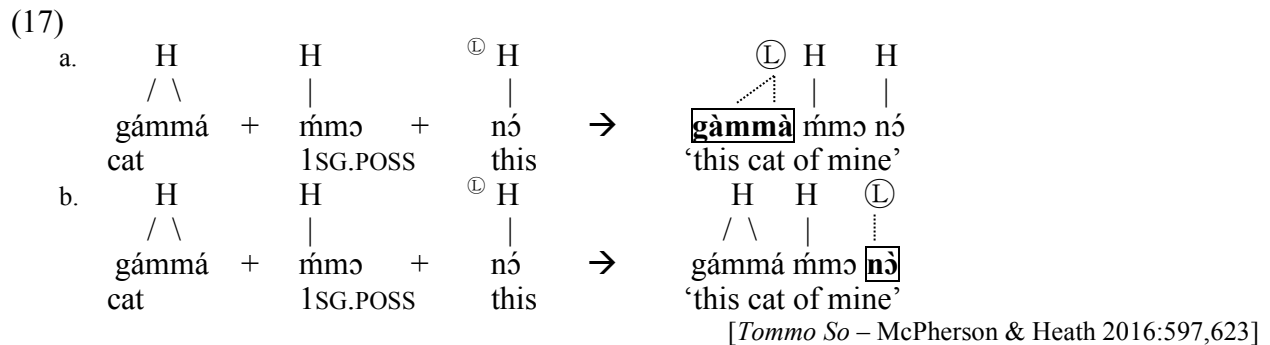

Across Tommo So (and indeed the Dogon family as a whole), the target of the grammatical tune are whatever morphemes are in its scope, potentially resulting in multiple host morphemes. It would therefore be uniform if we adopt that the target includes the possessor *m̄m̄ɔ* in (17) above, even though it cannot host the grammatical tune. The actual host *nó* in b. is not the target but only a ‘last resort option’ under exceptional conditions (emphasized by the authors).

We have sketched above situations in which these components - tune, trigger, sponsor, target, and host - are overt and transparent. Recall, however, that our definition of a tonological operation was not merely adding or replacing tone, but consists of the full range of tonal phenomena which include pure deletion, tone undocking and redocking to a different TBU (horizontal shifting), scalar tone shifts in 3+ height tone systems (vertical shifting), assimilation, dissimilation, plateauing, among many other types. As such, in many of these cases it may not be appropriate to identify one or more of these components. In Japanese, when certain affixes attach to a stem, they delete underlying tone on the stem. In (18)a., the suffix itself has an underlying tone, but in b. the suffix bears no tone and the result is an entirely toneless word (this gets a default prosodic pattern on the surface, post-phonology).

(18)

- a. /kíza + ppó-i/ → \kiza-p<sup>po</sup>i \ ‘snobbish’  
 /HØ + H-Ø/ → \ØØ-H-Ø\  
 b. /kéizai + teki/ → \<sup>ke</sup>izai-teki \ ‘economic’  
 /HØØØ + ØØ/ → \ØØØØ-ØØ\  
 \ØØØØ-ØØ\

[Japanese – Kawahara 2015:468,470]

In this case, we can call the suffix the trigger and the root the target of a tonological operation which deletes the underlying tone. However, there is no grammatical tune as such being assigned, and therefore there is no sponsor or host. Other cases involving non-straightforward grammatical tunes and hosts will be discussed as they come up below.

### 2.1.5 Grammatically natural classes

In many cases, a GT pattern is not restricted to a single morpheme but rather is present in the context of a number of morphemes which together form a **grammatically natural class**. For example in Kalabari in (5) above, the entire natural class of demonstratives covary with a LH replacive tone.

In many cases it may be difficult to confirm this aspect, as ascertaining grammatical naturalness often requires specialist knowledge of the language in question. Consider Giphende [<sup>pem</sup>] (Bantu – Hyman 2017:113-114), introduced above. Giphende has four types of grammatical H tones which dock to the left-edge of a noun, each showing different behavior. For example, the noun /gi-kómbó/ ‘broom’ (Fr: *balai*) in subject position surfaces as [gì-kómbó] with [LHH] (*gi-* is a nominal prefix NC7). In contrast, in ‘prédicatif’ position this is [gí-kómbó] with all high, and in object position it is [gí-<sup>+</sup>kómbó] with downstep. A schematic table is below. Note that the /L-/ portion of each noun is the nominal prefix.

		/L-LL/	/L-LH/	/L-HL/	/L-HH/
Ø		L-LL	L-LH	L-HL	L-HH
/ <sup>1</sup> /	[FOC]	H-HL	L-LH	L-HL	L-HH
/ <sup>2</sup> /	[GEN]	H-HL	H-LH	L-HL	L-HH
/ <sup>3</sup> /	[ACC]	H-HL	H-H <sup>+</sup> H	H- <sup>+</sup> HL	H- <sup>+</sup> HH
/ <sup>4</sup> /	[PRED]	H-HL	H-LH	H-HL	H-HH

Table 6: Giphende floating <sup>1</sup> grammatical tunes

(white = no docking; shades of grey = different surface values in column)

The underlying tones of nouns surface in citation, subject position, the object of a negative infinitive, and under left-dislocation, represented in the top row (with no floating tone). As seen, for all other rows the forms acquire a H tone, however with quite different properties. I label these as high tones <sup>1</sup>-<sup>4</sup> and posit features for each class based on Hyman’s description, e.g. [GEN] for genitive. The grammatical distribution of the four contexts is below.

Floating <sup>Ⓜ</sup> type	Feature	Grammatical distribution
Existential OCP <sup>5</sup> <sup>Ⓜ</sup> <sub>1</sub> ↔	[FOC]	focused object
Adjacent OCP <sup>Ⓜ</sup> <sub>2</sub> ↔	[GEN]	genitive, second object, object after negative verb, subject after relative verb
Downstepping <sup>Ⓜ</sup> <sub>3</sub> ↔	[ACC]	object after affirmative verb, object after <i>na</i> ‘with’
No OCP <sup>Ⓜ</sup> <sub>4</sub> ↔	[PRED]	predicative ‘it’s X’

Table 7: Giphende grammatical tones – Grammatical natural classes (?)

It is not straightforward whether the grammatical distribution forms a natural class, e.g. do the contexts of [GEN] form a natural class to the exclusion of the other contexts? In some cases, one may have to assume grammatical tone homophony, such as <sup>Ⓜ</sup><sub>2a</sub> ↔ [GEN] and also <sup>Ⓜ</sup><sub>2b</sub> ↔ [SUBJ.REL]. Because defining grammatical natural classes is more rightly under the purview of morphosyntax, we leave this issue aside.

## 2.2 Where is it and what is it for?

Like more familiar segmental units of contrast, tonemes can express the full range of grammatical meaning known to language, and can also come to cue grammatical meaning and constructions through tonological processes. In this section, I highlight the functions which GT plays in expressing grammatical meaning. It should be kept in mind that it is often an analytic decision whether to attribute a tonological change to a prosodic unit of contrast such as a toneme, as opposed to altering the phonological grammar in some way. This uncertainty extends to most cases of so called process morphology (Inkelas 2014). Therefore, even though in what follows I assume tonemes such as floating tones <sup>Ⓜ</sup> (as I have above), alternatives exist which do not involve such unit of contrasts.

### 2.2.1 GT as exponence

Grammatical tone can function to express grammatical meaning in three main ways. In one, a sequence of tonemes is the sole exponence of the grammatical meaning. For example, in the Igbo case in (7) above the associate construction [N1 <sup>Ⓜ</sup> N2] appears with a floating H, which we can call the exponence of a grammatical meaning ‘associative’, i.e. [ASSOCIATIVE] ↔ <sup>Ⓜ</sup>. I will refer to this situation as **independent prosodic exponence**, defined as follows:

[Def 16] **Independent prosodic exponence**: exponence of a grammatical category only by prosodic units of contrast (e.g. tonemes, accent, prosodemes, intonemes, *etc.*), with no segmental units of contrast (e.g. vowels, consonants, *etc.*)

I intentionally use the term ‘prosodic’ here to include prosodic units of contrast other than tone, although the focus of this typology will remain on GT. From the perspective of segmental exponence, independent prosodic exponence is often highlighted as remarkable and has been described with a number of special terms (‘tonal affix’, ‘tonal morpheme’, *etc.* – see list in Table 4 above).

In contrast is what I call **auxiliary prosodic exponence** in which a grammatical category is expounded both by segmental units of contrast and separately by prosodic units of contrast. An example of this was seen in Kalabari, in which nouns which co-occur with the demonstrative

<sup>5</sup> Existential refers to the fact that the mere existence of a H toneme anywhere within the domain causes the floating <sup>Ⓜ</sup><sub>1</sub> not to dock. ‘Existential OCP’ is equivalent to ‘skeleton-insensitive OCP’ in Hyman (2012:27).

‘this’ (neut.) have their underlying tones replaced by a [LH] grammatical tune. I hypothesize in this case the exponence to be [DEM][PROX][NEUT] ↔ /mí<sup>ⓁⓈ</sup>/, where the floating toneme sequence docks to the noun. We can define auxiliary prosodic exponence as the following:

[Def 17] **Auxiliary prosodic exponence:** the exponence of a grammatical category by segmental units of contrast (e.g. vowels, consonants, *etc.*), and by co-occurring *auxiliary* prosodic units of contrast (e.g. tonemes, accent, prosodemes, intonemes, *etc.*), separate from these segmental units of contrast

In the Kalabari demonstrative /mí<sup>ⓁⓈ</sup>/, the auxiliary prosodic exponents are the floating tones /<sup>ⓁⓈ</sup>/ which dock to the noun. The use of the term ‘auxiliary’ here is meant to differentiate it from ‘prosodic exponence’ generally, which includes both the floating tones and the H tone pre-linked to the segmental exponence /mí/. In several cases it will not be clear how to differentiate these, but in those cases where it is this terminology can be employed.

Auxiliary prosodic exponence is related to the family of phenomena known as ‘multiple exponence’ or ‘extended exponence’ (see Harris 2017 for a recent overview, which includes several examples of GT). I coin the term ‘auxiliary prosodic exponence’ rather than use a pre-existing term for several reasons. The first reason involves the definition of multiple exponence. The GT patterns presented above are in fact quite analogous to the early examples said to constitute multiple exponence (e.g. Matthews 1972:82; Matthews 1974). For example, in German, plurality is marked by a number of strategies including suffixes *-e/-er*, umlaut, and their combination:

(19)	Singular	Plural	Meaning
a.	Arm	Arm- <b>e</b>	‘arm’/‘arms’
b.	Vater	V <b>ä</b> ter	‘father’/‘fathers’
c.	Hals	H <b>ä</b> ls- <b>e</b>	‘neck’/‘necks’
d.	Bild	Bild- <b>er</b>	‘picture’/‘pictures’
e.	Wurm	W <b>ü</b> rm- <b>er</b>	‘worm’/‘worms’

[German - Matthews 1974: 149–150; modified from Harris 2017:18]

Auxiliary prosodic exponence most closely resembles those examples in c. and e. However, it is controversial whether examples of this type constitute multiple exponence. For Harris, the definition of multiple exponence crucially involves multiple realizations of a feature:

*“Multiple (or extended) exponence is the occurrence of **multiple realizations** of a single morphosemantic feature, bundle of features, or derivational category within a word.”*

[Harris 2017:9; bolding mine]

In the German example, the suffix *-e* and umlaut can appear independent from one another (a.-b.), or together (c.), and are therefore different realizations, meeting the definition.

However, Harris also notes the following:

*“The use of plural *-er* always coincides with the use of umlaut when possible; that is, when there is a back vowel in the last syllable of the noun stem, nouns that use an *-er* plural also undergo umlaut. Thus, the use of umlaut is predictable from the use of the *-er* plural suffix, and therefore... cannot be considered [multiple exponence].”*

[Harris 2017:18]



Rather, she calls these cases ‘bipartite morphemes’, which constitute cases when “one of the exponents is dependent upon the other in fulfilling the function or meaning that it fulfills” (p. 20). Unlike multiple exponence, bipartite morpheme constitutes a *single* realization. I therefore use the term auxiliary exponence in order to avoid these terminological complications, but am neutral as to their relationship.<sup>6</sup>

We have established independent prosodic exponence and auxiliary prosodic exponence. A third way in which grammatical tone functions to express grammatical meaning is not through exponence *per se*, but rather via another tonological process. This is the most abstract way in which GT expresses meaning. One example is from Jita [jɪtɪ] (Bantu – Downing 1996, 2014). Like in many Bantu languages, underlying H tones are not permitted to be adjacent. In Jita, Meeussen’s Rule applies which deletes the second of two adjacent Hs, i.e. /HH/ → \HØ\. However, the prefix /amá-/ YP ‘yesterday past’ is exceptional: with this morpheme it is the first /H/ which deletes (that one on /amá-/) rather than the second (so-called Reverse-Meeussen’s Rule). This is shown in (20) below.

- (20)
- |    |                                    |   |   |                    |
|----|------------------------------------|---|---|--------------------|
| a. | / a – <b>amá</b> – gósora /        | → | \ a – a <b>ma</b> – gósora \                | [a:magosóra]       |
|    | SM-YP-visit                        |   |   | ‘s/he visited’     |
| b. | / a – <b>amá</b> – kú – sakira /   | → | \ a – a <b>ma</b> – kú – sakira \           | [a:makusákira]     |
|    | SM-YP-OM-help                      |   |   | ‘s/he helped you’  |
| c. | / a – <b>amá</b> – kú – gósorera / | → | \ a – a <b>ma</b> – kú – <b>go</b> sorera \ | [a:makugósorera]   |
|    | SM-YP-OM-visit                     |   |   | ‘s/he visited you’ |
- [Jita – Downing 1996:64-67]

The exceptional deletion rule with /amá/ applies in all three examples when it is adjacent to a high tone. In contrast, the phonologically general Meeussen’s Rule applies only in c. when the object marker (OM) /kú-/ appears adjacent to a H-toned verb stem. Locations of H tone deletion in the output are boxed. Note that in the surface form in [ ], the location of H tone moves one TBU to the right due to an independent tone shift operation.

In the Jita example, we can say that the grammatical meaning is expounded as [YP] ↔ /amá/, but part of the indexation of this grammatical meaning is the idiosyncratic application of Reverse-Meeussen’s Rule. Note that issues such as this justify enriching the substance of exponence beyond merely segmental and prosodic units of contrast. In part II ‘A theory of grammatical tone’, I do so via Cophonology Theory allowing morpheme-conditioned constraint reranking.

### 2.2.2 Where is GT located in the world?

No previous survey exists to my knowledge which appraises tonal languages for the degree to which they employ grammatical tone. This is largely due to disagreement on what constitutes a tone language (e.g. ‘pitch accent’ systems like Japanese), and the lack of a coherent definition of grammatical tone itself. In what follows, I present a brief overview of where GT is most found. Those less interested in this brief areal typology can turn directly to section 2.3 discussing what meaning GT expresses.

<sup>6</sup> Moreover, by calling this auxiliary exponence, I avoid taking a stance as to whether the segmental material is ‘primary’ and the grammatical tone is ‘secondary’ (cf. Noyer 1997’s distinction between primary and secondary exponents), or whether GT constitutes what has been called ‘distributed exponence’ (whose definition depends on the author). See further discussion in Baerman, Brown, & Corbett (2010) and Caballero & Harris (2012).

Given my broad definition of GT as a grammatically-conditioned tonal operation, it would be both unfeasible and uninformative to distinguish languages with and without GT as a whole. Virtually all tonal languages exhibit GT, and it is exceptional to *not* have it. I instead summarize (1) areal trends involving independent prosodic exponence and auxiliary prosodic exponence in which the GT pattern can be said to more ‘directly’ correspond to grammatical meaning, and (2) trends where the degree of GT (whether exponence or non-exponence) is particularly high, often involving languages with several ‘layers’ of grammatical tone when morphemes and constructions are combined to express higher order meaning targets. Even noting these self-imposed restrictions, it is not feasible at this point to quantify a language as to the degree to which it employs GT. Any relevant quotient of GT would only be meaningful against the number of morphemes or constructions in the language which do *not* use GT, but which hypothetically could. Therefore, as I present the typological profiles of largescale areas the reader should keep in mind the inherent shortcomings of any such survey in the absence of quantitative data.

The map in Figure 3 from the *World Atlas of Language Structures* (WALS) illustrates the distribution of tone systems in the world’s languages (Maddieson 2013).

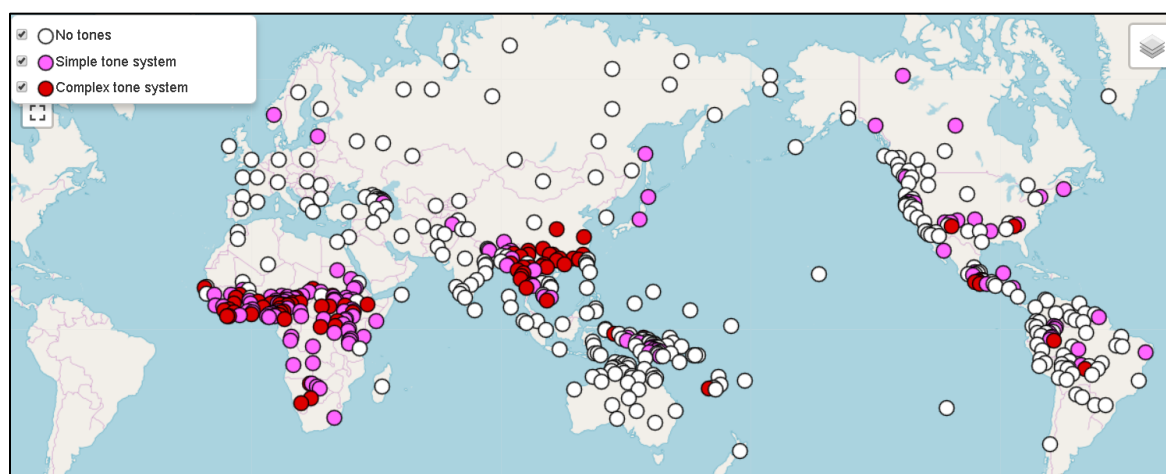

Figure 3: Map of tonal languages (WALS – Maddieson 2013)  
 [Simple systems = having only a two-way basic contrast, e.g. H vs. L/Ø]

From this map, areas with the highest concentrations of tone are (sub-Saharan) Africa, east and southeast Asia, and Mexico/southern USA. Smaller zones include northwest Canada, western Amazon, northern Europe, northern Pakistan, and New Guinea.

### 2.2.2.1 Africa

All tonal languages in Africa exhibit GT, typically robustly, and no language has been reported with only lexical tone (Hyman et al. in press). The widespread use of GT cuts across all other typological dimensions, such as toneme inventory, syllable shape phonotactics, degree of morphology, headedness parameter, *etc.* It is found robustly in both highly analytic languages such as the Ijoid family with almost no segmental morphology as well as in languages at the synthetic end e.g. Bantu, Kainji, and several Kordofanian languages. I will begin this discussion by moving west to east, discussing genetic families. I make no claim as to the validity of these groupings, and adopt them only out of convenience.

The Greenbergian stock Niger-Congo (Greenberg 1963) stretches from the Atlantic Ocean in Senegal west into Kenya/Somalia in the East, and southwardly to South Africa due to the Bantu expansion. In the far west, many Atlantic languages are toneless (e.g. Wolof, Fula, Sereer), but those that are tonal employ GT, e.g. Kisi [*kiz*] (South Atlantic – Childs 1995:55).

Moving eastward, GT plays a major role in both the nominal and verbal systems of the Dogon family in Mali (Prokhorov 2011; Heath & McPherson 2013; McPherson 2013, 2014; McPherson & Heath, 2016; a.o.), laid out extensively in McPherson (2014) where underlying tones of nouns and verbs are systematically overridden by modifier tones for nouns, and inflectional categories/affixes for verbs. In the same area, GT is widespread in Mande languages. Green (2018) lays out systematically the use of tone in marking [ASSOCIATIVE]~[N<sub>1</sub> N<sub>2</sub>] constructions across Mande, especially in the SW Mande branch such as Liberian Kpelle [xpe] (Welmers 1969), Bandi [bza] (Rodewald 1989), and Loma [lom] (Sadler 2006). Mande languages Seenku [sos] McPherson (2016, 2017a, 2017b) and Jalkunan [bxl] (Heath 2017) in the same proximity as the Dogon languages mentioned above also show complex grammatical tone behavior, the former illustrating grammatical tone sandhi (described in chapter 3). The Gur/Senoufo family of West Africa also robustly employs grammatical tone, such as Konni [kma] (Cahill 2000), Kabiye [kbp] (Roberts 2013, 2016), Dagbani [dag] (Hyman & Olawsky 2013), and complex changes in Supyire [spp] which straddle the grammatical tone/tone sandhi distinction (Carlson 1994). In the same wider area, the Kru family is less well-described but GT still has a clear function, e.g. in Guebié [gie] (Sande 2017) where GT is used to express aspectual difference (specifically expressing imperfective).

Moving further east, GT patterns proliferate across the Kwa subgroup, e.g. in Foodo [fod] marking imperatives (Plunkett 2009) and in Asante Twi [aka] marking the verb when a noun is extracted (Korsah & Murphy 2017:3 – example in (24) below). Within the neighboring Benue-Congo subgroup to its east, GT is widespread in the families Edoid (e.g. Elugbe 1989), Igboid (see above), Platoid (e.g. Izere [izr] - Lukas & Willms 1961), Delta-Cross (e.g. the extensive function of GT in in verb paradigms in Kana [ogo] – Ikoro 1996:375-404), and of course Bantu, discussed below. Note, however, that within this vast area GT plays a much smaller role in languages along the coast between Benin and SW Nigeria, e.g. the Defoid languages (e.g. Yoruba [yor]) and Gbe languages (e.g. Ewe [ewe]). These languages are exceptional in a number of other ways compared to other languages in their family/area, e.g. their radical analyticity (McWhorter 2016) and lack of cross-height ATR Harmony (Rolle, Faytak, & Lionnet 2017).

The geographically proximate but genetically unrelated Ijoid family employs GT to an extreme degree, with frequent use of the replacive GT type, as well as independent prosodic exponence and auxiliary prosodic exponence (Jenewari 1977; Williamson 1965, 1988; Eferé 2001; Harry 2004; Akinlabi et al. 2009; Harry & Hyman 2014). The example above in (13) from Kalabari [ijn] was representative of GT in this family. The grammatical tune starts from its sponsors and targets every morpheme within its relevant domain, resulting in mass neutralization. Despite this, all Ijoid languages maintain clear lexical tone contrasts.

Further east still but remaining within the Niger-Congo stock are the Adamawa, Gbaya and Ubangi families, all of which are noted as having GT, again, often robustly. These include Mambay [mcs] (Anonby 2008), Yakoma [yky] (Boyeldieu 1995), and many other Ubangian languages surveyed in Boyd (1995), as well as Gbaya languages, where floating tones are common as in Gbáyá Bòdòè [gya] (Roulon-Doko 1995:36). The Adamawa family is less well surveyed than the other two, but many languages transparently have GT, e.g. in Doyayo [dow] (Wiering & Wiering 1994) such as in marking valency changing in verbs (p. 120) or as auxiliary prosodic exponence marking aspect (p. 218). Note that GT in Doyayo appears to play a smaller role than in other African languages, and that this language is abundant with tonal minimal pairs (extensive list in Wiering & Wiering 1994:18-21).

In this area and moving southwardly to South Africa are the Bantoid and Bantu languages, a subgroup within Benue-Congo. Bantu GT systems constitute some of the most complex in Africa, at least on par with the extreme complexity found elsewhere (e.g. Nilotic, Otomanguean,

or (southern) Chinese tone sandhi systems). So-called ‘melodic tone’ marking inflectional verbal meaning is surveyed in great detail across Bantu in Odden & Bickmore (2014). It is not uncommon for lengthy descriptive books to be written titled ‘tonal grammars’ in which these complexities are laid out in incredible detail, e.g. of Setswana [tsn] (Creissels, Chebane, & Nkhwa 1997), Kinyarwanda [kin] (Kimenyi 2002), Sesotho [sot] (Khoali 1991), and Jita [jit] (Downing 1996). I discuss examples from Jita at several points in this thesis.

In at least one Bantu language, there is only grammatical tone and no lexical tone in any domain, namely Chimwiini [chim1312] (Kisseberth & Abasheikh 2011). Here, a single final or penultimate privative H tone is determined by the grammar, e.g. *ji:lé* ‘you sg. ate’, *ji:le* ‘s/he ate’ (Kisseberth & Abasheikh 2011:1994), and although the above contrast derives from the inflectional morphology of the verb, it is realized phrasally: *jile ma-tu:ndá* ‘you sg. ate fruit’, *jile ma-tú:nda* ‘s/he ate fruit’. Other H tones are assigned by relative clauses, conditional clauses introduced by *ka-*, the negative imperative, and the conjunction *na* ‘and’ (pp. 1990-1992).

The three remaining Greenbergian stocks are Afroasiatic, Nilo-Saharan, and Khoisan. Within Afroasiatic, tone is widespread in the Chadic, Cushitic, and Omotic branches but virtually absent in the others. Where it exists, it plays a major role. For example, in Chadic there is extensive documentation and theory dedicated to Hausa [hau] GT (e.g. Newman 1986; Inkelas 1998), and patterns are common in other languages too such as Muyang [muy] (Smith & Gravina 2010:122) where “the tone on the root...is grammatically predictable in most forms of most verbs” and Ngamo [nbh] genitive GT (Schuh 2017:141). Similar findings can be found in the Cushitic though to a smaller degree, e.g. in Somali [som] case marking on nouns (Hyman 1981b) and has an important role in verbal inflection in Ts’amakko [tsb] (Savà 2005:32,145ff.; verb paradigms 166-170). It is important to note that in these languages, tone plays a small role at the lexical level, to such a degree that they are often not even understood to be tone languages (Klingenheben 1949, Hyman 2009). Several languages proposed to be within the Omotic family exhibit replacive tone on nouns, such as in Northern Mao [myf] (Ahland 2012) and Ganza [gza] (Smolders 2016), the latter describing it as idiosyncratically assigned tonal ‘construct melodies’. Whether or not ‘construct melodies’ constitute GT is discussed in chapter 3.

GT is extremely widespread in the Nilo-Saharan stock as well, quite famously within the Nilotic family (Maasai [mas] – Tucker & Mpaayei 1955; Shilluk [shk] – Gilley 1992, Remijsen & Ayoker 2014; Dinka [din] – Andersen 1995), but also further west in Central Sudanic (e.g. Kabba [ksp] - Moser 2007; Baka [bdh] - Waag & Phodunze 2015). Finally, I have not thoroughly surveyed the last Greenbergian stock Khoisan (uncontroversially constituting several genetically unrelated families), and will not speculate as to the degree which it employs GT.

### 2.2.2.2 Asia

The other major zone for tone languages is East and Southeast Asia. In contrast to Africa, the distribution of grammatical tone in Asian tonal languages is far more restricted, although certainly present. Asian tonal systems show a different typological profile from the rest of the world, as detailed in many tonological survey work (Yip 2002, Hyman 2018b).

Starting in the west, northern Pakistan has a number of tonal languages with GT, e.g. Kohistani Kalam [gwc] (Baart 1999a,b, 2004; analyzed in Zimmermann 2016). Moving into the Sino-Tibetan languages (which includes Chinese), the Tibetan languages have some degree of what can be called GT in their nominal compounds (see Duanmu 1992 and references therein), as do at least some Naga languages (minimal GT in Karbi [mjw] – Konnerth 2014), some Kuki-Chin languages (Kuki-Thaadow [tcz] - Hyman 2007), and the Na-Qiangic language Yongning Na [nru] (Michaud 2017). In general, however, languages within the Sinosphere have been heavily influenced by Chinese descriptive practices in which tonal manipulations are often characterized as tone sandhi. Major Chinese languages such as Mandarin and Cantonese have

widespread lexical tone contrasts (with ample minimal pairs) and very little GT compared to African languages. Where GT does exist, it does not form a central part of the inflectional system of nouns or verbs. Note that of the major Sinitic languages, the Shanghainese dialect of Wu Chinese [wuu], resembles the Ijoid languages described above in that the first morpheme~phonological word in a phonological phrase conditions tone changes on all subsequent units. Whether this is best characterized as Tone Sandhi or GT is often subject to the tradition of specific linguistic researcher communities.

South of the expansive Tibetan-Chinese area are several subgroups all of which contain languages with tone, but to various degrees: non-Tibetan/Chinese Tibeto-Burman (e.g. Lolo-Burmese, Karen families), Tai-Kadai, Austroasiatic, Hmong-Mien, and Chamic (in the Austronesian phylum). Compared to Africa, GT plays a much smaller role in tonal languages here, in line with the areal trend. GT is lacking for the most part in the major national languages Thai, Vietnamese, and Burmese (although for Burmese see Allot 1967). Even in those languages where something like GT occurs with more frequency (such as Hmong languages - Ratcliff 2010), it is much more limited than in the African context. I will not list here all of the languages for which it has been observed that GT is limited or lacking entirely, though the list is extensive.

One exception to the areal trend is Japanese and Japonic lects, which have prolific GT typically of the auxiliary prosodic exponents type. Kawahara (2015) lists the extensive ways in which tone (i.e. pitch accent) is manipulated in the context of various affixes, and a large literature exists by both theoreticians (Poser 1984) and Japonicists detailing GT across Japonic lects (Kubozono & Giriko 2018), although it is almost never described as ‘grammatical tone’.

### 2.2.2.3 Other zones: North America, Mexico, the Amazon, Europe, Oceania/New Guinea

From the map in Figure 3 above, we can see additional tone areas in North America, Mexico, the Amazon, Europe, and Oceania/New Guinea. In North America, more simplex tone systems are found in northwest Canada consisting of Dene languages. This zone stretches southwardly into the US, with a large number of tonal languages in the south and southeast US. GT is much rarer here than in Africa (or at least described in different terms), but unlike Asian languages discussion of tone sandhi is virtually non-existent. GT plays a role in Karuk [kyh] (Sandy 2014, 2017), Hidatsa [hid] (Park 2012), Cherokee [chr] (Uchihara 2016, particularly discussion of floating<sup>®</sup> tones), and Arapaho [arp] (Cowell & Moss 2008).

Moving south, tonal languages are abundant in Mexico, in northwest Mexico e.g. Choguita Rarámuri [tar] (Caballero 2018) and several other Uto-Aztecan languages, in several Mayan languages in the southeast, and most famously the Otomanguean family in the south. Of these, the last has the most robust GT and some of the most complex tone systems in the world, and are far too large to summarize here – for an overview see Palancar & Léonard (2016). As in Africa, GT plays a central role in all grammatical meaning in these languages, especially in the intersection of verb class membership and verbal inflection, and are frequently cited in exemplifying the outer limits of morphological exponents. For example, Baerman, Brown, & Corbett (2010:7-8) highlight what they refer to as ‘distributed exponents’ in Chiquihuitlán Mazatec [maq] (Jamieson 1982:152,166-167). They show that subject agreement is realized in three positions in the verbal word: in the final vowel, in the prefixed initial syllable, and in the tone. Importantly, they note the following (using the verb ‘gather’ as their point of reference):

*“These three systems vary independently of each other, with each one falling into distinct inflectional classes in their own right... In terms of its final vowel inflection, ‘gather’ forms a class with ‘return’, but not with the others. Its prefixal inflection groups it with ‘pull out’, while its tonal inflection matches that of ‘take out’. That is, the verb ‘gather’ simultaneously belongs to three inflectional classes, depending on which subsystem one is looking at. And the verbs*

‘return’, ‘pull out’ and ‘take out’ in turn pattern with still other verbs, forming a network of interlocking inflectional classes.”

[Baerman, Brown, & Corbett 2010:7]

	‘gather’	‘return’	‘pull out’	‘take out’
1SG	čha <sup>3</sup> ya <sup>1</sup>	bu <sup>1</sup> ya <sup>1</sup>	čha <sup>3</sup> ně <sup>1</sup>	ba <sup>3</sup> šæ <sup>1</sup>
2SG	hba <sup>2</sup> ye <sup>2</sup>	bo <sup>3</sup> ye <sup>2</sup>	hba <sup>3</sup> ye <sup>31</sup>	nã <sup>2</sup> še <sup>2</sup>
3	čha <sup>3</sup> ya <sup>2</sup>	bu <sup>3</sup> ya <sup>2</sup>	čha <sup>3</sup> ně <sup>1</sup>	ba <sup>3</sup> šæ <sup>2</sup>
1INCL	hba <sup>2</sup> yã <sup>2</sup>	bu <sup>3</sup> yã <sup>2</sup>	hba <sup>3</sup> ně <sup>31</sup>	nã <sup>2</sup> še <sup>2</sup>
1PL	hba <sup>2</sup> yĩ <sup>24</sup>	bu <sup>3</sup> yĩ <sup>24</sup>	hba <sup>3</sup> nĩ <sup>14</sup>	ba <sup>3</sup> šĩ <sup>24</sup>
2PL	hba <sup>2</sup> yũ <sup>2</sup>	bu <sup>3</sup> yũ <sup>2</sup>	hba <sup>3</sup> nũ <sup>1</sup>	ba <sup>2</sup> šũ <sup>2</sup>

Table 8: Interlocking inflectional classes involving tone in Chiquihuitlán Mazatec

Because GT plays such a central role in these languages, they will be oversampled in the typological and theoretical discussion which follows, just as African languages are.

Within the Amazon, tone is an areal feature of the Vaupes Region (the red dots in NW South America on the map in Figure 3), and sporadically elsewhere. For GT, Barasana [[bsn](#)] (Gomez & Kenstowicz 2000) is often cited as having tonal changes present in noun compounds. Most languages in South America however have more limited GT compared to Africa and Mexico. Ticuna [[tca](#)] (Skilton 2017), one of the largest languages of the area, has a limited amount of grammatical tone, as does Maihiki [[ore](#)] (Skilton & Farmer 2015) where verb-verb compounds involve GT. A thorough examination of the grammar of Hup [[jup](#)] (Epps 2008) shows that GT plays only a small role:

*“In addition to lexical tone, Hup also has two grammatical uses of tone. First, in the basic imperative mood..., the verb stem appears bare (i.e., without a Boundary Suffix) and its final syllable (which may belong either to a root or to an Inner Suffix) invariably receives a high (falling) tone. ... Tone also plays a role in the derivation of nouns from verbs in Hup, although the productivity of this process is limited...”*

[Epps 2008:97]

I am unaware of the extent that GT is used in other Amazonian tone languages outside this area, although GT in Urarina [[ura](#)] (Olawsky 2006) will be discussed below.

Finally, simplex tonal systems are found in parts of Europe (e.g. Swedish [[swe](#)], Lithuanian [[lit](#)], Limburgan [[lim](#)], Serbo-Croatian [[hbs](#)]), and are very well represented across New Guinea. There exists a small pocket of tonal languages in New Caledonia as well, clearly an innovation from non-tonal Oceanic languages. I have not thoroughly surveyed any of these regions for GT, which is important to admit as this constitutes dozens (perhaps hundreds) of additional tonal languages. It is quite clear that GT is employed in many New Guinean languages, e.g. in Gadsup [[gaj](#)] noun phrases (Pennington 2014) and Iau [[tmu](#)] tense/aspect/mood inflection (Bateman 1990a, 1990b, discussed in Hyman 2016). For an overview of the tonal diversity of languages in Papua New Guinea (including discussion of GT), see Cahill (2011).

### 2.2.3 Expressing meaning

Hyman (2011) states unequivocally that tone’s ability to expone grammatical meaning is comparable to the more familiar case of exponence-as-segments. To conclude this chapter, I will discuss some of this ability. First, in those languages which use GT more sparingly (such as in Asia), there is a tendency to employ it to express derivational change, such as changes in part of

speech, or other similar meaning alterations. Those languages where GT is used heavily also employ it in their inflection system, an extremely common situation across Africa. Given our broad definition of GT as grammatical condition tonological operation, it would be both unfeasible and uninformative to catalogue all meanings associated with GT. This section will only examine common grammatical meaning realized via independent prosodic exponence and auxiliary prosodic exponence.

First, the bread-and-butter of GT is expressing derivation such as valency changes and category-changing. This is found in virtually every flavor, and is found even within Asian tonal languages which generally lack GT. For example, Kam (1980:218-224) summarizes five classes of ‘semantic-tonal alternations’ in Thai, which we might consider GT, but notes they are no longer productive. These mostly include derivational changes of part of speech, e.g. verbal denominalizations (N>V), nominal deverbalizations (V>N), adjectival denominalizations and deverbalizations (N>A, V>A), and adverbial deverbalizations (V>Adv). Similarly, Cantonese largely lacks GT, but has a set of derived nouns from verbs showing replacive tone, e.g. /ta:m<sup>53</sup>/ ‘to carry’ > /ta:m<sup>44</sup>/ ‘a burden’; Yip (2002:107) points out that ‘most of them are not productive these days’.

GT is used to express inflectional meaning and grammatical relationships as well. In the verbal sphere, tone can expone the full range of grammatical meaning including argument agreement (person/number/gender/animacy/etc.), tense, aspect, mood, and even polarity, such as in Aboh Igbo [ukw]:

(21) GT exponing negation

- |    |         |           |                     |
|----|---------|-----------|---------------------|
| a. | ò jè kò | \ L L L \ | ‘s/he is going’     |
| b. | ó jé kò | \ H H L \ | ‘s/he is not going’ |

[Aboh Igbo - Hyman et al. in press]

This is especially true across Africa, where it is extremely common to find that verb roots do not have underlying tone, or have a smaller set of contrasts than nouns (or other parts of speech). In many cases, tone has an exclusively grammatical function in the verbal domain. Examples cut across major families, languages including Kisi [kiz] (Atlantic - Childs 1995:55), Konni [kma] (Gut - Cahill 2000), Cishingini [asg] (Kainji - author field notes), the entire Edoid family (Elugbe 1989), Zande [zne] (Ubangian - Boyd 1995), and numerous Bantu languages (Odden & Bickmore 2014). It is my impression that imperatives are often expressed by independent prosodic exponence and that this is a trend even outside of Africa. For example, the Hup language of South America [jup] (Epps 2008:797) generally lacks GT although uses it in expressing imperatives.

The interaction of grammatical tone expressing derivational and inflectional meaning can be extremely rich and varied. One profitable way of illustrating such complex grammatical tone interaction is through **tonological paradigms**, such as in Table 9 below from Dinka [din] (Trommer 2011:133, interpreting Anderson 1995:52-53). Derivational categories are at the top, while inflectional categories are on the left side, all of which are expressed through GT and other segmental and suprasegmental stem changes. Derivational categories are expressed through GT in the context of inner inflection, evidenced by the consistent vertical tone marking in the top half of the table. Note that the lexical tones of the roots have an effect in a minority of cells where the two tables have different values, highlighted in light grey. In contrast, derivational GT generally loses to outer inflection GT, seen in the consistent horizontal tone marking in the bottom half of the table (with the exception of two cells with [H] tone, indicated in dark grey). Such tonological paradigms illustrate that GT expressing derivational and inflectional meaning can be as interwoven as in complex segmental morphology.

		Derivational					Derivational					
		Ø	CF/B	CP	BAP	AP	Ø	CF/B	CP	BAP	AP	
Inner Infl	FIN	L	H	L	F	F	FIN	L	F	L	F	F
	1/3S	L	H	L	F	F	1/3S	L	F	L	F	F
	PL	H	H	L	F	F	PL	H	F	L	F	F
	NF	F	H	L	F	L	NF	L	F	L	F	F
Outer Infl	NTS	H	H	H	H	H	NTS	H	H	H	H	H
	PAS:CT	F	F	F	F	F	PAS:CT	F	F	F	F	F
	PAS	H	F	F	F	F	PAS	H	F	F	F	F
	2SG	L	L	H	L	L	2SG	L	L	H	L	L
Root = CVC (H)						Root = CVC (L)						

Table 9: Derivational, inflectional, and lexical tone interaction in Dinka (Glosses: FIN=finite, NF=non-finite, NTS=non-topic subject, PAS:CT=passive circumstantial, CF=centrifugal, B=benefactive, CP=centripetal, BAP=benefactive antipassive, AP=antipassive)

Like in the verbal domain, GT can express the full range of nominal inflectional found for segmental exponence. Nominal inflectional categories include definiteness, specificity, demonstratives, numerals, quantification, plurality~number, gender~classification, case, among others. Many of these cases involve auxiliary prosodic exponence. One common change involving independent prosodic exponence is expounding number and noun class membership, e.g. singular/plural pairs in Izere [*izɾɾ*] (Blench 2000), whereby LL singular becomes MH plural with no other changes, but the opposite is also attested, i.e. singular MH → plural LL. Within Bantu it is common for modifiers of nouns to co-occur with tonal manipulations of the noun, e.g. in Jita [*jit*] (Downing 2016) in which nominal modification can result in H tone placed on the final TBU of the noun. In Kalabari [*ijn*] (Ijoid – Harry & Hyman 2014), different modifiers co-vary with distinct grammatical tunes, e.g. HL (possessives nouns. numeral 1), HLH (possessive pronouns), LH (demonstratives, ‘which’), and L (‘some’, numerals 4 and above).

One robust pattern found across Africa involves GT marking [ $N_1 N_2$ ] constructions (expressing associative, genitive/possession, noun compounds, a.o.). This was shown above in (7) in Igboïd involving a floating <sup>Ⓣ</sup> between the two nouns. GT in this context is found widely cutting across stocks, e.g. in the Niger-Congo stock such as the Mande family (Green 2018) in the far west, the Afro-Asiatic phylum such as the Chadic family in the center (Schuh 2017:141), and even the Nubian family in the far east (compounds in Midob [*mei*] – Werner 1993:24). Marking a noun in this construction may constitute case marking, which GT marks in sometimes extreme ways. For instance, in Tugen [*tuy*] (Jerono 2013), there are at least 15 distinct input-output mappings involving the underlying tones of a noun (absolute form) and its tone pattern in nominative (=subject) context. In these cases, it may be more profitable to analyze the nominative forms as distinct allomorphs, rather than try to derive them through tonological processes.



	Pattern #	Absolutive (=Elsewhere)	Tone	Nominative (=Subject)	Tone	Gloss
a.	1	kibùkàndiì	L	kibùkàndíí	LH	guitar
	2	chèèp-ò	L	chéép-ò	HL	daughter of
b.	3	kwááríík	H	kwááriik	HL	tendon
	4	móítá	H	mòità	L	calf
	5	káályááng'ík	H	kààlyááng'ík	LH	flies
c.	6	mùrsiík	LH	mùrsiik	L	sour milk
	7	chèèmòòsíí	LH	chéémóósíí	H	ogre
d.	8	káámèè	HL	kààmèè	L	mother
	9	cháálwòòk	HL	cháálwóók	H	wrongdoing
	10	séèsèè	HL	sèèséé	HLH	dog
e.	11	láàkwéé	HLH	láàkwéé	H	child
	12	òinòòsyék	HLH	òinòòsyèk	HL	rivers
f.	13	ùsíí	LHL	úsíí	H	thread
g.	14	bèèlyóòndé	LHLH	béèlyóóndé	H	elephant
	15	kikóòmbéé	LHLH	kíkóòmbéé	HLH	cup

Table 10: GT patterns expounding nominative case in Tugen (Jerono 2013)

We saw an instance of marking case in Bantu above in Table 7 involving Giphende where floating tones with distinct tonological behavior corresponded to different abstract cases, e.g.  $\text{①}_2 \leftrightarrow [\text{GEN}]$  and  $\text{①}_3 \leftrightarrow [\text{ACC}]$ .

The use of tone in expressing  $[\text{N}_1 \text{N}_2]$  constructions may be interpreted as GT marking a grammatical construction rather than a specific morpheme *per se*. One common instance of GT marking a construction is with  $[\text{VERB OBJECT}] \sim [\text{OBJECT VERB}]$  constructions. In these cases, the most straightforward analysis is that the verb and object form a constituent of some sort (often including other morphemes) over which a particular tonal pattern spreads. This is shown below in Izon [*ijc*] and Urarina [*ura*].

(22)

- a. Noun tone class A: / bùrù<sub>A</sub> fè / → bùrù **fè** ‘buy a yam’  
b. Noun tone class B: / námá<sub>B</sub> fè / → námá **fè** ‘buy meat’  
c. Noun tone class C: / òró<sub>C</sub> fè / → òró **fè** ‘buy a mat’  
[Gbarain Izon - author fieldnotes]

(23)

- a. GT pattern A – initial H:  
/ lureri  $\text{①}_A$  + kwarakãu / → lureri **kwá**rakãu ‘I have seen the house’  
b. GT pattern C – final H:  
/ komasaj  $\text{①}_C$  + kwarakãu / → komasaj kwarakã**ú** ‘I have seen the wife’  
[Urarina - Olawsky 2006:128]

In Izon in (22), nouns are split into three tone classes A, B, and C (idiosyncratically associated with lexical items), whose effects are seen on the following verb. Tone class A assigns a LH pattern, class B spreads the H tone from the noun, and class C assigns a L tone. This overwrites the underlying tone of the verb and is therefore replacive. In Urarina in (23), nouns also form lexically idiosyncratic tone classes depending on where they assign tone. For example, class A assigns a H to the initial TBU of the verb, while class C assigns a H to the final TBU.

GT can also play a role in signaling syntactic processes. For example in Asante Twi [*aka*], Korsah & Murphy (2017) show that verbs are marked with a replacive H tone if an object is

extracted over them to the left edge of the clause, e.g. as in (24). Note that the underlying tones of the verbs /kaé/ /LH/ ‘remember’ and /kítá/ /LL/ ‘hold’ are both uniformly \H\ in the extracted context. These tonal changes do not take place if the object remains *in situ*.

- (24) déén<sub>i</sub> na Kofí **káé** se Ám<sup>+</sup>má **kítá** t<sub>i</sub>  
 what FOC Kofí remember that Ama hold  
 ‘What does Kofí remember that Ama is holding?’

[Asante Twi - Korsah & Murphy 2017:3]

Given the wide range of meanings GT can expone, I adopt the following null hypothesis following extensive work by Hyman (and others) on GT.

[Def 18] **Non-restrictive prosodic exponence**: all grammatical meaning can be expressed by segmental exponence, by prosodic exponence, or their combination

If this hypothesis is correct, there should be no grammatical meaning which *cannot* be exponed entirely or partially through prosodic units of contrast such as tonemes~GT, and equally there should be no grammatical meaning which can *only* be exponed via prosodic units of contrast.

I should mention, however, that there are several places where GT exponence is not common. Grammatical material which tends to be independent phonological words and not morphologically bound rarely (if ever) show independent prosodic exponence (although frequently show auxiliary prosodic exponence, of course). These include question *wh*-words, demonstratives, pronouns, quantifiers, auxiliaries, adverbs, and complementizers. Let us think of a hypothetical example. Spanish expresses proximate and distal meanings via pre-modifier morphemes exponed segmentally. We could easily imagine these meanings being exponed as three distinct floating toneme sequences which dock to a (toneless) noun, i.e. a hypothetical noun /mana/ ‘man’ surfacing as the following:

	Spanish		Hypothetical GT language	
	DEM	<i>hombre</i> ‘man’	DEM	/ mana / ‘man’ / τ τ /
‘this’	<i>este</i>	<i>este hombre</i> ‘this man’	Ⓣ	\ máná \ ‘this man’ 
‘that’	<i>ese</i>	<i>ese hombre</i> ‘that man’	ⓂⓉ	\ māná \ ‘that man’ 
‘that over there’	<i>aquel</i>	<i>aquel hombre</i> ‘that man over there’	Ⓛ	\ màná \ ‘that man over there’ 

Table 11: Hypothetical independent prosodic exponence of demonstrative values

More challenging is the following typological claim: it is uncommon for GT to expone clause-level grammatical meaning (that which is often associated in the CP field in generative linguistics). This includes complementation, evidentiality, adverbials of many types, and perhaps most surprisingly information structure such as types of topic and focus. If cases like this are truly rare or even non-existent cross-linguistically, it becomes a challenge to the typologist whether to interpret this as a systematic or accidental gap.

This may or may not be a quirk of African languages, where GT is overwhelmingly found. For example, in Kalinowski’s (2015) survey of focus encoding in African languages,

grammatical tone plays a relatively small role across in the continent. Of the 135 languages surveyed in her study, only 12 were said to use prosody to encode focus. Of these, there is little to no indication by Kalinowski that these involve tone changes. One example is verbal focus involving verbal copying with a L tone in the Chadic language Ma'di [mhi] (Kalinowski 2015:377, citing Blackings & Fabb 2003:24). Kalinowski herself remarks on this:

*“[W]hat is meant by focus constructions are those constructions which are used typically for encoding ‘new’ information, as can be identified by answers to wh-questions or in contrast to a given element. In African languages, this encoding is typically morphosyntactic in nature. While it is not unreasonable to expect some prosodic correlates of focus constructions, this is not the primary means of focus encoding in the languages studied here, and **most of the descriptions used in the creation of the database make little or no mention of the role of prosody in information structure.**”*

[Kalinowski 2015:34; bolding mine]

However, one place where tonal effects are associated with information structure is in Bantu languages, especially in the conjoint/disjoint distinction, e.g. Luganda [lug] (Hyman & Katamba 1993), Ekoti [eko] (Schadeberg & Mucanheia 2000), Makhuwa [vmw] (Van der Wal 2006), among others (for a cross-Bantu perspective, see Van der Wal & Hyman 2017). Refer also to the Bantu language Giphende discussed above in Table 7 where  $\textcircled{1} \leftrightarrow [\text{FOC}]$ .

# **Chapter 3**

## **GT dominance effects (and beyond)**

### 3.1 Dominant and non-dominant grammatical tone

#### 3.1.1 Overview

Recall the following definitions from chapter 2:

- (1)
- a. **Grammatical tone:** the unique tone sequence (or set of tone sequences) which covaries with the grammatical tone construction
  - b. **Trigger:** the morpheme or construction which licenses the tonological operation
  - c. **Sponsor:** the morpheme (or natural class of morphemes) which covaries with the grammatical tone
  - d. **Target:** the morpheme or morphemes which is the intended undergoer of a tonological operation
  - e. **Host:** the morpheme or morphemes on which the grammatical tone appears
  - f. **Valuation window:** the portion of the target-host which is evaluated with respect to whether its TBUs are valued or unvalued

When the trigger and sponsor are the same or if they cannot be reasonably distinguished, I call it the trigger-sponsor. The same holds for using the term target-host.

Recall also from the previous chapter that **valued** morphemes are said to have underlying tone while **unvalued** morphemes lack underlying tone, repeated in Table 1. Valued TBUs  $\tau$  are said to be linked to a tone T, while unvalued TBUs  $\tau$  are not linked to a T.

Valued					Unvalued
H	H L	H L	H	T	
	∨		^		
$\tau$	$\tau$	$\tau \tau$	$\tau \tau$	$\tau$	$\tau$

Table 1: Tonal values

Interactions between the trigger-sponsor and the target-host based on their morphosyntactic identity and tonal value are referred to as **GT dominance effects** ('dominance' *à la* Kiparsky & Halle 1977, Kiparsky 1984, Inkelas 1998). We can divide GT dominance effects into two main types: **dominant GT** and **non-dominant GT**. Each of these has two sub-types. Dominant GT is split into **replacive-dominant GT** and **subtractive-dominant GT**, while non-dominant is split into **recessive non-dominant GT** and **neutral non-dominant GT**.

[Def 1] **Replacive-dominant GT:** the automatic replacement of the underlying tone of within the valuation window of a target-host, revalued with a grammatical tone (whether via a floating tone, spreading from the sponsor, *etc.*)

[Def 2] **Subtractive-dominant GT:** the automatic deletion of the underlying tone of within the valuation window of a target-host, *without* target-host revaluation by a grammatical tone

[Def 3] **Recessive-non-dominant GT:** the non-application of the grammatical tone when a target-host is valued within its valuation window (occurs primarily within privative-culminative systems)

[Def 4] **Neutral-non-dominant GT**: the lack of automatic replacement/deletion of the underlying tone of the target-host or automatic non-application of the grammatical tune

The table below illustrates these patterns schematically.

	Target-host	Valued	Unvalued
		T T     τ τ	τ τ
Trigger-sponsor		/ /	/ /
Replacive-dominant	T <sup>Ⓣ</sup>   τ	T <sup>Ⓣ</sup>   \n τ τ τ	T <sup>Ⓣ</sup>   \n τ τ τ
Subtractive-dominant	T   τ	T   τ τ τ	T   τ τ τ
Recessive-non-dominant	T <sup>Ⓣ</sup>   τ	T T T       τ τ τ	T <sup>Ⓣ</sup>   \n τ τ τ
Neutral-non-dominant	T <sup>Ⓣ</sup>   τ	T <sup>Ⓣ</sup> T T   \n     τ τ τ	T <sup>Ⓣ</sup>   \n τ τ τ

Table 2: Types of GT triggers

The trigger-sponsor is on the left in black, and consists of a pre-docked tone and a floating tone<sup>Ⓣ</sup> with the exception of subtractive-dominant GT. The target-host is at the top in red, of two types: valued target-hosts where their TBUs are pre-linked to tonemes, and unvalued target-hosts with unvalued TBUs.

With replacive-dominant GT, the floating tone<sup>Ⓣ</sup> replaces the underlying tones of the valued target, and as such neutralizes the distinction between valued and unvalued target-hosts. With subtractive-dominant GT, the presence of the appropriate trigger results in deletion of the underlying tones, even though there is no floating tone and thus no replacement. This also results in neutralization of the two input types. This type of neutralization is what Hyman (2018a) calls ‘intentional neutralization’ as opposed to types of ‘incidental neutralization’ where the “process in question has neutralization as an innocent bystander” (p. 8).

In contrast, the floating tone of recessive-non-dominant GT docks to unvalued targets but does *not* dock to valued targets. This system is largely restricted to privative-culminative systems, defined below. Finally, neutral-non-dominant GT shows docking no matter what the input but no replacement. With unvalued targets, this docks to both TBUs, and with valued targets this docks to the first TBU, resulting in a contour. Non-dominant GT does not result in neutralization of the two input types, the critical distinguishing characteristic from dominant GT.

Metaphorically, dominant triggers are assertive and bold (they dominate), and impose their pattern (or lack of pattern) regardless of the content of the input. Recessive triggers are timid and reluctant (they recede), and only impose a pattern when none already exists (without the relevant window). Neutral triggers are neither (they are ‘cooperative’), and therefore calling them ‘triggers’ rather than simply ‘sponsors’ may be slightly misleading. I will retain this terminology for consistency.

### 3.1.2 Dominance terminology in the literature

The terminology used in describing **dominance effects** is frequently employed in accentual systems. This goes back at least as far as in Indo-European accent studies (Kiparsky & Halle 1977), and has been applied to languages including (Vedic) Sanskrit, Lithuanian, Russian, a.o. (Kiparsky 1982, 1984; Melvold 1986; Halle & Vergnaud 1987a,b; Steriade 1988; Golston 1990; Blevins 1993; Sandell 2011; Petit 2016; Kushnir 2018; see Yates 2017 for extensive references). Outside of Indo-European, dominance terminology has been extended perhaps most famously to Japanese (Poser 1984, Kawahara 2015), but also to Xârâcùù [ane] (Rivierre 1978), Moses-Columbia Salish [col] (Czaykowska-Higgins 1993), Hausa [hau] (Inkelas 1998), Ese Eja [ese] (Vuillermet 2012, Rolle 2016, Rolle & Vuillermet *in press*), the Dogon family (McPherson 2013, 2014:61fn3, McPherson & Heath 2016), and a number of languages surveyed in Alderete (2001a, 2001b).

In their original conception, Kiparsky & Halle (1977) analyze the rules governing Indo-European **accent systems**. They designate certain positions of morphemes as accented, and present different kinds of accentual classes (studies including Sanskrit, Lithuanian, and Russian). Discussing Lithuanian, Kiparsky & Halle use dominance in the following way:

*Morphemes are marked with a feature +high (h) on some mora, and a +high may further be either dominant (<sup>∗</sup>ϕ) or recessive (ϕ)...*

*The first dominant +h vowel in a word is accented; if there is none, the first +h is accented.*

[Kiparsky & Halle 1977:215; underlying theirs]

This definition is compatible with dominance being either a phonological designation – i.e. the [+high] feature itself being marked as [DOM] or [REC] – or a morphological designation – i.e. the morpheme containing the [+high] feature being marked [DOM] or [REC].

Sanskrit also shows dominant and recessive patterns, showing the accentual classes in (2)-(4). The accent systems discussed are all subject to culminativity (Hyman 2009), resulting in multiple accents underlyingly, but only one surfacing in a (phonological) word.

- |     |  |  |                  |
|-----|--|--|------------------|
| (2) | <b>Dominant</b> <i>-in</i> adjective-forming |  |                  |
| a.  | Unvalued                                     | / pakṣ + <b>-in</b> + -i: + -nám / → \ pakṣ <u>in</u> i:na:m \ | ‘having wings’   |
| b.  | Valued                                       | / áśv + <b>-in</b> + -i: + -nám / → \ áśv <u>in</u> i:na:m \   | ‘having horses’  |
| (3) | <b>Recessive</b> <i>-é</i> dative singular   |  |                  |
| a.  | Unvalued                                     | / duhitar + <b>-é</b> / → \ duhitar- <u>é</u> \ [duhitré]      | ‘daughter (DAT)’ |
| b.  | Valued                                       | / bhrá:tr + <b>-é</b> / → \ <u>bhrá</u> :tar-e \ [bhrá:tare]   | ‘brother (DAT)’  |
| c.  | Valued                                       | / marút + <b>-é</b> / → \ ma <u>ru</u> t-e \ [marúte]          | ‘wind (DAT)’     |
| (4) | <b>Deaccenting</b> vocative singular         | [=Subtractive-Dominant]  |                  |
| a.  | Unvalued                                     | / duhitar / → \ duhitar \ [dúhitar]                            | ‘daughter (VOC)’ |
| b.  | Valued                                       | / bhrá:tr / → \ <u>bhra</u> :tr \ [bhrá:tar]                   | ‘brother (VOC)’  |
| c.  | Valued                                       | / marút / → \ ma <u>ru</u> t \ [márut]                         | ‘wind (VOC)’     |

Dominant *-in* deletes accent on preceding valued stems, recessive *-é* has its accent deleted in the context of a valued stem, and deaccenting vocative deletes accent without assigning a new one (equivalent to subtractive-dominant). Note that in this last case, surface primary stress falls on the leftmost mora in the word, shown in square brackets representing the surface form.

Note that these original works did not flesh out any distinction between ‘recessive’ and ‘neutral’ non-dominant GT. For example, Inkelas (1998) employs the terms ‘dominant’ and ‘recessive’ in the sense of Kiparsky (1982, 1984):

*“I will start by using “dominance” in the sense of Kiparsky (1982c, 1984a), who described as “dominant” affixes which idiosyncratically cause the deletion of structure, usually tone or stress, from the base they attach to, often but not necessarily substituting a new pattern in place of the deleted material. “Recessive” affixes do not cause such deletion.”*

[Inkelas 1998:122]

Here, ‘recessive’ has a purely negative definition and therefore corresponds more accurately to my use of ‘neutral’. Similarly, in Yates’ (2017) recent work on Lexical Accent systems, he distinguishes dominant affixes as the following:

*“Descriptively, this label [Dominance] is applied to cases in which an affix imposes its accentual specification on its base in a way that is inconsistent with the language’s general morphophonological principles of stress assignment”*

*“I adduce evidence for accentually dominant morphemes, accented suffixes that defy the BAP [Basic Accentuation Principle] by attracting stress in preference to an accented stem to their left”*

[Yates 2017:25;2]

This implicitly distinguishes only dominant ([+DOM]~[DOM]) from non-dominant ([-DOM]~[Ø]). This non-dominant value resembles my study’s ‘neutral’ category.<sup>1</sup>

What is often called ‘neutral’ in this literature refers to cases which have no prosodic specification whatsoever, e.g. Kiparsky (1984:203 – “‘neutral’ suffixes have no accentual effects”). That use of ‘neutral’ would be understood in my typology as a grammatical context which has no grammatical tone effect whatsoever, *not* to ‘neutral GT’.

### 3.1.2.1 Terms recessive vs. neutral

Conceptually, ‘recessive’ and ‘neutral’ are distinct. Recessive triggers show automatic non-application when a target is valued, while neutral triggers do not show this feature. This is schematized below with hypothetical roots and two hypothetical homophonous affixes –é, one recessive and one neutral, based on the Sanskrit example above. The difference between them is boxed and in bold.

(5) Schematized distinction between recessive and neutral triggers:

- a. Recessive –é
- |           |              |   |      |   |   |
|-----------|--------------|---|------|---|---|
| Unvalued: | / ττ         | + | -é / | → | ττ- <span style="border: 1px solid black; padding: 0 2px;">é</span> |
| Valued:   | / <b>ṭ</b> τ | + | -é / | → | <span style="border: 1px solid black; padding: 0 2px;">ṭ</span> τ-e |
- b. Neutral –é
- |           |              |   |      |   |  |
|-----------|--------------|---|------|---|--|
| Unvalued: | / ττ         | + | -é / | → | ττ- <span style="border: 1px solid black; padding: 0 2px;">é</span>  |
| Valued:   | / <b>ṭ</b> τ | + | -é / | → | <span style="border: 1px solid black; padding: 0 2px;">ṭ</span> τ- <span style="border: 1px solid black; padding: 0 2px;">é</span> ~ ττ- <span style="border: 1px solid black; padding: 0 2px;">é</span> (R-most) ~ <span style="border: 1px solid black; padding: 0 2px;">ṭ</span> τ-e (L-most) |

When a phonological grammar allows tone/accent sponsored from different morphemes to co-exist in the output, the difference between recessive triggers and neutral triggers is clear: the grammatical tune does not dock to the target with the recessive triggers, but it *does* dock with

<sup>1</sup> Also in Indo-European, ‘recessive’ has a different meaning in the term ‘recessive accentuation’. For Ancient Greek, Yates (2017:14) shows that it means something akin to ‘default stress’:

*“In Greek, the default stress pattern is “recessive accentuation” (see Probert 2006: 128–44), which assigns stress—realized as high tone—to final vocalic mora [sic] of the word’s antepenultimate syllable when the final syllable is light (modulo final consonant extrametricality)”*



neutral triggers. However in practice, it can be difficult to distinguish the two, especially if the language is a privative-culminative prosodic system which allow only one primary prosodic prosodeme (e.g. a single primary accent or a single high toneme). In these cases, the rightmost or leftmost of the accents may ‘win’, as shown after the ~ in (5)b. above. Here, tone/accent deletion does not happen ‘automatically’ due to any property of the trigger, but rather happens due to independent constraints in the language enforcing culminativity.

Consider the case of Indo-European, brought up by Yates. In this grammar, only one accent may surface (=primary stress) due a culminativity constraint. Indo-Europeanists recognize a ‘Basic Accentuation Principle’ (BAP) operating in many languages, stating that in cases where more than one accent occur, the leftmost accent is retained while all others are deleted. This can be called a ‘Leftmost Wins’ effect. Such effects are only sensitive to phonological structure and not to morphological structure; the trigger of this process therefore can be said to be a purely phonological condition. However, we can also attribute accent deletion here as due to there being a recessive trigger, which is a morphological condition. This ambiguity is illustrated below with the Sanskrit affix *-é* (repeated from (3) above).

- (6)
- a. **Morphological condition – Recessive trigger**  
 / marút + -é / → \ marút-e \ [marúte] ‘wind (dat)’  
 / target + trigger / → target – trigger
- b. **Phonological condition – ‘Leftmost wins’**  
 / marút + -é / → \ marút-e \ [marúte] ‘wind (dat)’  
 / left + right / → left - right

One accentual system is claimed to have a three-way distinction between dominant, recessive, and neutral triggers, namely Ese Ejja [*ese*] a Tacanan language of Peru and Bolivia, for which I have done primary analysis (Rolle 2016, Rolle & Vuillermet in press). [Note that the superscript <sup>x</sup> indicates ‘not attested’ in a corpus of data.]

- (7) Dominant *-ka* 3A ‘3<sup>rd</sup> person indexation (agreement)’
- a. / kwyá + ó...-ka / → \ kwyá-ka- \
- b. / baná + ó...-ka / → \ bána-ka- \
- c. / ishe’á + ó...-ka / → \ ishe’a-ka- \
- (8) Recessive *-nahe* PST ‘past tense’
- a. / ishe’á + -ó<sup>o</sup>nahe / → \ ishe’á-nahe \ (<sup>x</sup>\ ishe’á-nahe \ )
- b. / ishe’a-ka + -ó<sup>o</sup>nahe / → \ ishe’a-ka-nahe \ (<sup>x</sup>\ ishe’á-ka-nahe \ )
- c. (cf. Unvalued / towaa + -ó<sup>o</sup>nahe / → \ towáa-nahe \ )
- (9) Neutral (+ Rightmost) *-he* FUT ‘future tense’
- a. / ishe’á + -ó<sup>o</sup>he / → \ ishe’á-he \ (<sup>x</sup>\ ishe’á-he \ )
- b. / ishe’a-ka + -ó<sup>o</sup>he / → \ ishe’á-ka-he \ (<sup>x</sup>\ ishe’a-ka-he \ )
- c. (cf. Unvalued / towaa + -ó<sup>o</sup>he / → \ towáa-he \ )

[Ese Ejja – Rolle & Vuillermet in press]

The dominant trigger *-ka* 3A ‘3<sup>rd</sup> person indexation’ in (7) replaces input stress with stress on the initial syllable of the target-host. In (8), the recessive trigger *-nahe* ‘past’ assigns stress to the second syllable before it if the target-host is stressless (unvalued); otherwise no stress changes take place. Finally, in (9) the neutral trigger *-he* ‘future’ assigns stress two syllables before it, but does this regardless of whether the target-host is stressed or unstressed (9). In this case, due to culminativity stress surfaces only on the rightmost of the two stresses. In comparing all three

triggers, the neutral trigger exhibits stress non-uniformity: the stem accent wins in a. being rightmost in the output, but the affixal accent from *-he* wins in b. also rightmost in the output. To distinguish recessive from neutral here, it is critical that the underlying accent be in a range of positions in the target-host, and that the trigger can assign a non-local grammatical tune to the penult. In most languages, unfortunately, these ‘ingredients’ will not be present.

Ambiguity between ‘recessive’ and ‘neutral’ triggers with grammatical tone was seen in Giphende [pem] (Hyman 2017:113-114), introduced in chapter 2. This involved different types of floating  $\text{H}^{\text{H}}$  tones showing distinct behaviors. The basic facts are repeated schematically in Table 5 below.

			/L-LL/	/L-LH/	/L-HL/	/L-HH/
$\emptyset$			L-LL	L-LH	L-HL	L-HH
$\text{H}^{\text{H}}_1/$	[FOC]	Recessive	$\text{H}^{\text{H}}-\text{H}^{\text{H}}\text{L}$	L-LH	L-HL	L-HH
$\text{H}^{\text{H}}_2/$	[GEN]	Recessive	$\text{H}^{\text{H}}-\text{H}^{\text{H}}\text{L}$	$\text{H}^{\text{H}}-\text{LH}$	L-HL	L-HH
$\text{H}^{\text{H}}_3/$	[ACC]	Neutral	$\text{H}^{\text{H}}-\text{H}^{\text{H}}\text{L}$	$\text{H}^{\text{H}}-\text{H}^{\text{H}}\text{H}$	$\text{H}^{\text{H}}-\text{HL}$	$\text{H}^{\text{H}}-\text{HH}$
$\text{H}^{\text{H}}_4/$	[PRED]	Neutral	$\text{H}^{\text{H}}-\text{H}^{\text{H}}\text{L}$	$\text{H}^{\text{H}}-\text{LH}$	$\text{H}^{\text{H}}-\text{HL}$	$\text{H}^{\text{H}}-\text{HH}$

Table 3: Giphende floating  $\text{H}^{\text{H}}$  grammatical tunes (white = no docking; shades of grey = different surface values in column)

I consider floating tones  $\text{H}^{\text{H}}_1/$  and  $\text{H}^{\text{H}}_2/$  to be recessive triggers and  $\text{H}^{\text{H}}_3/$  and  $\text{H}^{\text{H}}_4/$  to be neutral triggers. It is clear that an OCP condition is present in the language, which is resolved in different ways (or not at all for  $\text{H}^{\text{H}}_4/$ ). It may be possible to configure the resolution of this markedness constraint through referring to morphological information (e.g. recessive vs. neutral triggers) or *only* to phonological information (e.g. directionality, *etc.*).

### 3.1.2.2 Dominance in other phonological phenomena

Dominance as understood for other phonological phenomena is not the same as in grammatical tone or in prosodic systems generally. This is summarized by Inkelas (1998) who emphasizes that they do not involve ‘morphological idiosyncrasy’:

*“The term ‘dominance’ has been used in other ways as well. For example, Kiparsky and Halle (1977:215 ff.) characterize as ‘dominant’ certain Baltic accents, which are subject to a context-sensitive rule of Deaccentuation (p. 216). Vowel harmony systems in which affixes (not roots) control harmony are also sometimes referred to as ‘dominant’ (e.g. v. d. Hulst and v. d. Weijer 1995:496, 514), as are bidirectional vowel harmony patterns (Halle and Vergnaud 1981). These three uses of the term do not involve morphological idiosyncrasy.”*

[Inkelas 1998:151,fn 1]

Of the other designations of dominance, perhaps the most common is in vowel harmony systems (e.g. Bakovic 2000, among many others). For example, within [+ATR] systems common across parts of Africa, [+ATR] vowels have ‘advanced tongue root’ represented as e.g. /i e ə o u/ due to F1 effects from tongue root, while [-ATR] vowels have retracted tone root represented as e.g. /ɪ ɛ a ɔ ʊ/ (see in particular Casali 2003, 2008, 2016 and Rolle, Faytak & Lionnet 2016 for extensive references). ATR harmony systems restrict co-occurrence of vowels from these two sets in specific ways.

Within ATR harmony, Casali notes that “ATR harmony languages in which [+ATR] vowels are dominant” whereby [-ATR] vowels assimilate to [+ATR] vowels but not conversely” are “quite strongly attested” (Casali 2016:97), while the opposite is rarer. In this situation, there are

two potential values for a ‘harmony bearing unit’: [+ATR] (the dominant value) or [-ATR] (the non-dominant value). This can be called **phonological dominance**.

This is unlike the use of ‘morphological’ designation of dominance in grammatical tone systems (**morphological dominance**). Under GT, a trigger is described as dominant when it systematically imposes its pattern regardless of the input value of the target. Crucially, the exact values of the trigger and target do not condition this application. For example, if a dominant trigger has a floating high tone and the target has low tone, the high tone overwrites the low. Equally, if a dominant trigger has a floating low tone and the target has high tone, the floating low still overwrites, even if it is *phonologically* dominant as is common in tone systems. Simply put, the exact content of the tonemes are irrelevant in predicting the output, which is the opposite of phonological dominance.<sup>2</sup>

Further, in chapter 2 we established the ‘trigger’ and the ‘grammatical tune’, and showed that they do not need to bear the same value, e.g. Tommo So trigger /nó/ ‘this’ with underlying /H/ tone but covaries with a L toned grammatical tune <sup>Ⓣ</sup> which docks to the target, e.g. /gámmá/ ‘cat’ + /nó/ ‘this’ → \gàmmà nó\ ‘this cat’. We can call this **trigger-tune mixed valuation**, a situation not found with phonological dominance. In other words, we don’t see cases where one set of [+ATR] suffix triggers [+ATR] values on target vowels, but another set of [+ATR] suffixes triggers [-ATR] target vowels. One can imagine even more complex autosegmental ‘tunes’ which could rival some more complex ones found in GT, e.g. a language with one set of dominant affixes triggering a <sup>[+NASAL] [-NASAL]</sup> tune on a target, and another set of dominant affixes triggering a <sup>[-NASAL] [+NASAL]</sup> one. Under this unattested situation, the contrast between the two inputs /daba/ and /nāmā/ would be nullified: \nāba\ with the <sup>[+NASAL] [-NASAL]</sup> tune and \damā\ with the <sup>[-NASAL] [+NASAL]</sup> tune.

### 3.1.3 Dominant GT

#### 3.1.3.1 Replacive-dominant

Let us exemplify dominance effects beginning with replacive-dominant GT, a term attributable to Inkelas (1998:139), building on the Africanist term **replacive tone** (Welmers 1973:132-3). The definition from [Def 1] is repeated below:

- (10) **Replacive-dominant GT:** the automatic deletion of the underlying tone within the valuation window of a target-host, revalued with a grammatical tune (whether via a floating tone, spreading from the sponsor, *etc.*)

Replacive-dominant GT operates within a word as in Hausa [hau] in (11) (word-level), and across words as in Kalabari [i j n] in (12) (phrase-level).

(11)	Replacive-dominant GT (word)		/ -óóCíí / PLURAL \ Ⓣ HH \	
a.	HHL / líkítà / ‘doctor’	→	líkít-óócíí	‘doctors’
b.	LHH / kààsúwá / ‘market’	→	káásúy-óóyíí	‘markets’
c.	LHLH / tààtsúúniyáá / ‘bird’	→	táátsúúniy-óóyíí	‘birds’

[Hausa – Inkelas 1998:124]

<sup>2</sup> Some [ATR] systems show what is called ‘root-controlled’ or ‘root dominance’ in which the ATR value of the lexical root governs the ATR value of the word as a whole (or some other such domain). Such a use of ‘dominance’ is more akin to the one used here. A case of ATR harmony purported to be more akin to grammatical tone is the Kindigué variety of Bondu-So [dbu], a comparison made overt recently in Green & Hantgan-Sonko (2018).

(12)	Replacive-dominant GT (phrase)	/ mí <sup>ⓁⓅ</sup> / ‘this’ (neut.)	/ mí <sup>↑</sup> ná <sup>ⓁⓅ</sup> / ‘these’
		\ H ⓁⓅ \	\ H <sup>↑</sup> H ⓁⓅ \
a.	HH / ná má / ‘meat’	mí <b>námá</b>	mí <sup>↑</sup> ná <b>námá</b>
b.	LL / pù ò / ‘oil’	mí <b>pùló</b>	mí <sup>↑</sup> ná <b>pùló</b>
c.	HL / bé lè / ‘light’	mí <b>bèlé</b>	mí <sup>↑</sup> ná <b>bèlé</b>
d.	LH / gà rí / ‘garri (food)’	mí <b>gàrí</b>	mí <sup>↑</sup> ná <b>gàrí</b>
e.	H <sup>↑</sup> H / bá <sup>↑</sup> rá / ‘hand’	mí <b>bàrá</b>	mí <sup>↑</sup> ná <b>bàrá</b>

[Kalabari - Harry & Hyman 2014:6]

In Hausa, nouns have underlying tone which is deleted when it forms a plural with the suffix /-óóCíí/ PLURAL (where C = copy consonant). The noun is revalued by a H tone, which targets every TBU of the noun as shown in the 4-σ/7μ noun in (11)c. The revalued tune is represented as ⓁⓅ in the output \ \ in this example for convenience sake, and is most economically understood as tone spreading from the affix rather than a floating tone.

In (12), Kalabari nouns are given with five different underlying tone values. The underlying tones of the noun are replaced with a [LH] grammatical tune when they are modified by any demonstrative (an independent word) in [DEM N] constructions. Unlike with the Hausa case, the grammatical tune is independent of the tonal value of the trigger and is therefore better analyzed as floating tone rather than spreading.

Dominance effects are an idiosyncratic property of the trigger, and whether it is dominant or non-dominant cannot be predicted from other factors, such as segmental or prosodic substance, markedness of the grammatical tune, morphosyntactic classification, or its morphosyntactic position relative to the target-host or other triggers. This property of the trigger is referred to as **lexical idiosyncrasy**, following Inkelas (1998:128) and Alderete (2001b:214). This does *not* claim that patterns cannot emerge within single grammars, or that trends do not exist cross-linguistically. For example, for Sanskrit accent Kiparsky (1984a:206) shows that dominant triggers are located more inwardly in the morphological structure than ‘recessive’ triggers, shown in later work that this is a quirk of Sanskrit rather than a cross-linguistic universal, or even tendency.<sup>3</sup> Inkelas (1998:123) is quite explicit stating that “dominance effects do not always correlate with morphological layering”. We will return to ‘layering’ later in this chapter.

In the sense adopted here, the notion of lexical idiosyncrasy does not preclude all members of a grammatical class acting uniformly, as in Kalabari. In (12), the demonstratives /mí/ ‘this’ (neut.) and /mí<sup>↑</sup> ná/ ‘these’ both covary with the LH grammatical tune, as do demonstratives /bí/ ‘this’ (m.), /má/ ‘this’ (f.) ~ ‘these’, and /tò/ ‘which’. Recall from Chapter 2 that our definition of grammatical tone includes the provision that it can be restricted to a natural class of morphemes or constructions. This tonal effect from the natural class of demonstratives is lexically idiosyncratic in that all non-demonstratives do *not* assign this pattern, and rather assign other grammatical tunes or none at all. Whether or not this entails that the grammatical tune should be linked to the individual lexical items or not remains an open question.

### 3.1.3.2 Subtractive-dominant

The second type of dominant GT is subtractive-dominant GT:

- (13) **Subtractive-dominant GT:** the automatic deletion of the underlying tone within the valuation window of a target-host, without target-host revaluation by a grammatical tune

<sup>3</sup> See also Heath & McPherson (2013) for an analysis correlating dominant GT with a semantic property.

An example of subtractive-dominant GT is the Japanese suffix *-teki* in (14) which automatically deletes tone in the target and results in a toneless output (note that the surface form surfaces with a default prosodic pattern at a later stage, not indicated here).

(14) Subtractive-dominant GT

	/ target + trigger /			
a.	/ <u>anáta</u> + teki /	→	<u>anata</u> -teki	‘in your opinion’ (colloquial)
b.	/ <u>ronri</u> + teki /	→	<u>ronri</u> -teki	‘logical’
c.	/ <u>búngaku</u> + teki /	→	<u>bungaku</u> -teki	‘literature-like’

[Japanese – Kawahara 2015:470]

The suffix results in deletion of accent anywhere within the target-host, whether it be two, three, or four moras away. In this case, we can say that the **valuation window** – defined as the portion of the target-host assessed for being valued or unvalued – is the coextensive with the target-host. The valuation window is denoted via a dotted box.

We can compare this to cases in which the valuation window is not coextensive with the target-host, exemplified with the Japanese case marker *-no* GENITIVE (see Kawahara 2015 for references on its accentual behavior). This subtractive-dominant suffix (/enclitic) can delete an accent only if it is on the final mora of the target-host, shown in (15).

(15) Subtractive-dominant GT with local valuation window

	/ target + trigger /			
a.	/ <u>atamá</u> + no /	→	ata <u>ma</u> -no	‘head-GEN’
	/ <u>kawá</u> + no /	→	ka <u>wa</u> -no	‘river-GEN’
b.	/ <u>ínoti</u> + no /	→	ínoti-no	‘life-GEN’
	/ <u>kokóro</u> + no /	→	kokóro-no	‘heart-GEN’
c.	/ <u>masín</u> + no /	→	masín-no	‘machine-GEN’
	/ <u>koozyóo</u> + no /	→	koozyóo-no	‘factory-GEN’
d.	/ há + no /	→	há-no	‘tooth-GEN’
	/ kí + no /	→	kí-no	‘tree-GEN’

[Japanese – Kawahara 2015:471]

In example a., the stems /atamá/ ‘head’ and /kawá/ ‘river’ have a final accent, which is deleted when *-no* is present. In contrast, examples b. and c. show that if accent is not on the final mora then *-no* cannot delete it, e.g. stems such as /ínoti/ and /masín/ retain their accent in the output (note that coda /n/ is moraic). A further relevant aspect *-no* is that it also cannot delete accent from a monomoraic target-stem as in d.

In this case, the valuation window is only a single mora (the relevant TBU) which is immediately adjacent to the trigger. I call this a **local valuation window**. This is effectively the only area within the target-host which can be evaluated with respect to being valued or unvalued, and the only area which can be manipulated by the dominant trigger. We will return to variations of valuation windows in section 3.3.6 below.

Subtractive-dominant GT is part of a general family of **subtractive morphology** (Martin 1988; Anderson 1992; Broadwell 1993; Kurisu 2001; Alderete 2001a, 2001b; Alber & Arndt Lappe 2012; Inkelas 2014:60-65). Under subtractive morphology, a morphological category is expounded through the deletion of some material in the morphological base. This deletion is not driven by any markedness considerations and therefore cannot be understood as a general consequence of the phonological grammar (at least in any straightforward manner). An oft-cited example is from Tohono O’odham [ood] (Fitzgerald & Fountain 1995):

(16) Subtractive morphology in Tohono O’odham (Fitzgerald & Fountain 1994:5-6, as represented in Trommer 2011:67)

	Imperfect	Perfect	
a.	má:k	má:	‘giving’
b.	hí:nk	hí:n	‘barking’
c.	híhi:m	híhi	‘walking’ (pl)
d.	gátwid	gátwi	‘to shoot object’
e.	híkčk	híkč	‘cutting’
f.	čičiwi:d	čičiwi	‘covering’
g.	náko:g	náko	‘enduring’

Here, the final segment of the root (expressing imperfect aspect) is deleted to express perfect aspect.

However, not all instances of what can be classified as ‘subtractive morphology’ (1) appear without overt affixation, and (2) express a clear meaning. Consider Aymara [ayr] ‘vowel suppression’ (Kim 2003). Aymara is a highly synthetic language with numerous suffixes. These suffixes idiosyncratically encode whether the previous vowel deletes (‘is suppressed’) or does not delete (most morphemes underlyingly end in a vowel). For example, the ‘distancing suffix’ – *nuku* does not suppress the preceding vowel shown in (17)a., while the ‘diffusive’ suffix – *naqa* with a similar phonological shape shows suppression (17)b.

- (17)
- |    |   |   |                         |              |
|----|---|---|-------------------------|--------------|
| a. | <i>apa</i> ‘carry’ + <i>nuku</i> (distancing) | → | \ <b>apa</b> -nuku-ña \ | ‘abandon’    |
| b. | <i>apa</i> ‘carry’ + <i>naqa</i> (diffusive)  | → | \ <b>ap</b> -naqa-ña \  | ‘manipulate’ |
- [Aymara – Kim 2003:1]

Subtractive-dominant GT more closely resembles this latter type of subtractive morphology. Under GT, the subtraction of underlying tones does not typically indicate any meaning, only in conjunction with an overt segmental trigger. Using the typological terminology established in chapter 2, subtractive-dominance GT usually constitutes ‘auxiliary prosodic exponence’ rather than ‘independent prosodic exponence’.

One aspect of the subtractive morphology cases (e.g. final consonant deletion in Tohono O’odham or vowel suppression in Aymara) is that the target of deletion in subtractive-dominant GT is a single unit of contrast, i.e. a single vowel or consonant, or a single higher-order constituent such as a single syllable. It is unclear how well this generalization carries over to subtractive-dominant GT, i.e. are there cases which target a single toneme for deletion. At present, there are too few cases to make a confident generalization, and instances within privative-culminative prosodic systems such as Japanese are ambiguous.

One potential case of single-toneme subtractive-dominance is from Baka [bdh] (Waag & Phodunze 2013):

		Intransitive ndéré ‘go’	ógu ‘come’	Transitive ímbíóto ‘lift and put’	1 <sup>st</sup> τ
Inflected	1s	má-ndéré	má-ógu	má-ímbíóto	H
	2s	ndéré	ógu	ímbíóto	H
	3s	<b>ndéré</b>	<b>ógu</b>	<b>ímbíóto</b>	<b>L</b>
	1p	<b>ndéré-zé</b>	<b>ógu-zé</b>	<b>ímbíóto-zé</b>	<b>L</b>
	2p	ndéré-sé	ógu-sé	ímbíóto-sé	H
	3p	<b>ndéré-ní</b>	<b>ógu-ní</b>	<b>ímbíóto-ní</b>	<b>L</b>
Connective	1s	zí=ma ndéré=ma	zí=ma ógu=má	zí=ma ímbíóto	H
	2s	zí=yí ndéré=yí	zí=yí ógu=yí	zí=yí ímbíóto	H
	3s	zí=a ndéré=ne	zí=a ógu=né	zí=a ímbíóto	H
	1p	zí=ze ndéré=ze	zí=ze ógu=zé	zí=ze ímbíóto	H
	2p	zí=se ndéré=se	zí=se ógu=sé	zí=se ímbíóto	H
	3p	zí=ye ndéré=ye	zí=ye ógu=yé	zí=ye ímbíóto	H

Table 4: Subtractive-dominance in a local valuation window (?)

[Baka - Waag & Phodunze 2013:137-138]

This table shows three verbs, intransitive *ndéré* ‘go’ and *ógu* ‘come’, and transitive *ímbíóto* ‘lift and put’. Underlying, all verbs have an initial high tone on the initial TBU (even in infinitives and derivatives). Verbs are inflected for person/number by prefixes, suffixes, and tone changes, see in the top half. Important for our purposes, in 3<sup>rd</sup> singular, 1<sup>st</sup> plural, and 3<sup>rd</sup> plural the initial high tone is deleted in all three verbs (shown in bold and boxed); all other underlying tonemes are unaffected. We can compare this to connective paradigm in the bottom half. These occur with an auxiliary *zí* and show different inflection patterns. Importantly, neither the auxiliary nor the verb in this instance shows deletion of the initial H. Whether this is truly subtractive-dominant GT of a single toneme requires more in-depth analysis (a clear alternative being a docked floating <sup>Ⓣ</sup>), beyond our scope here.

### 3.1.4 Non-dominant GT

#### 3.1.4.1 Recessive-non-dominant

The first type of non-dominant GT is recessive GT, whose definition is repeated below:

- (18) **Recessive-non-dominant GT:** the non-application of the grammatical tune when a target-host is valued within its valuation window (occurs primarily within privative-culminative systems)

Recessive GT is found almost entirely in privative-culminative prosodic systems, meaning those systems which have only a presence vs. absence distinction (e.g. /H/ vs. Ø - privativity) and allow only one of these tonemes per domain (culminativity). An example of a recessive trigger from Japanese is in (19) (Kawahara 2015:468).

- (19) Japanese recessive suffix /<sup>Ⓣ</sup>si/ ‘Mr.’
- | Unvalued     |   | Valued       |   |
|--------------|---|--------------|---|
| a. /ono/     | → | \onó-si\     | /úra/ → \úra-si\ (*urá-si)                |
| b. /yosida/  | → | \yosidá-si\  | /múráki/ → \múráki-si\ (*murakí-si)       |
| c. /edogawa/ | → | \edogawá-si\ | /nisímura/ → \nisímura-si\ (*nisimurá-si) |

The ‘pre-accenting suffix’ /<sup>Ⓣ</sup>si/ ‘Mr.’ assigns a H tune to the final mora of the target *only if* the host is unvalued, e.g. /ono + <sup>Ⓣ</sup>si/ → \onó-si\ ‘Mr. Ono’. In contrast, if the target is valued and has

an underlying tone, the H tune is not assigned, e.g. /úra + <sup>Ⓣ</sup>si/ → \úra-si\ ‘Mr. Ura’ (cf. \*úrá-si\, \*úrá-si\).

Recessive GT may also show evidence for valuation windows. Giphende [pem] was introduced above, involving different types of floating <sup>Ⓣ</sup> showing distinct behaviors. These facts are repeated below in schematic form in Table 5.

		/L-LL/	/L-LH/	/L-HL/	/L-HH/
∅		L-LL	L-LH	L-HL	L-HH
<sup>Ⓣ</sup> <sub>1</sub> / [FOC]		<sup>Ⓣ</sup> - <sup>Ⓣ</sup> L	L-LH	L-HL	L-HH
<sup>Ⓣ</sup> <sub>2</sub> / [GEN]		<sup>Ⓣ</sup> - <sup>Ⓣ</sup> L	<sup>Ⓣ</sup> -LH	L-HL	L-HH
<sup>Ⓣ</sup> <sub>3</sub> / [ACC]		<sup>Ⓣ</sup> - <sup>Ⓣ</sup> L	<sup>Ⓣ</sup> - <sup>Ⓣ</sup> H	<sup>Ⓣ</sup> -HL	<sup>Ⓣ</sup> -HH
<sup>Ⓣ</sup> <sub>4</sub> / [PRED]		<sup>Ⓣ</sup> - <sup>Ⓣ</sup> L	<sup>Ⓣ</sup> -LH	<sup>Ⓣ</sup> -HL	<sup>Ⓣ</sup> -HH

Table 5: Giphende floating <sup>Ⓣ</sup> grammatical tunes (white = no docking; shades of grey = different surface values in column)

For the purposes of this discussion, let us consider recessive triggers to be floating tones <sup>Ⓣ</sup><sub>1</sub>/ and <sup>Ⓣ</sup><sub>2</sub>/ and neutral triggers to be <sup>Ⓣ</sup><sub>3</sub>/ and <sup>Ⓣ</sup><sub>4</sub>/. The former two show recessive properties in that they do not dock to target-hosts with certain underlying tones (i.e. are valued).

<sup>Ⓣ</sup><sub>1</sub>/ (which I refer to as [FOC]) only docks to /L-LL/ nouns, which we may interpret as /∅-∅/ valued with [L] only by default. <sup>Ⓣ</sup><sub>2</sub>/ [GEN] is also recessive in the sense that it cannot dock next to an input /H/, i.e. to /∅-H∅/ (/L-HL/) and /∅-HH/ (/L-HH/) target-hosts, but in contrast it does can dock to other target-hosts. This last fact reveals that <sup>Ⓣ</sup><sub>2</sub>/ has a local valuation window: only a valued TBU among the first two TBUs target-host results in the non-application (and deletion) of the floating tone. These facts are schematized further below, where valuation windows are in the dotted box.

- (20) Recessive GT <sup>Ⓣ</sup><sub>1</sub>
- a. /<sup>Ⓣ</sup><sub>1</sub> + L-LL/ → \<sup>Ⓣ</sup>-<sup>Ⓣ</sup>L\
- b. /<sup>Ⓣ</sup><sub>1</sub> + L-LH/ → \L-LH\  
 /<sup>Ⓣ</sup><sub>1</sub> + L-HL/ → \L-HL\  
 /<sup>Ⓣ</sup><sub>1</sub> + L-HH/ → \L-HH\  
 (Note: In the original image, the L-LH, L-HL, and L-HH targets in (20b) are enclosed in dotted boxes, indicating they are unvalued.)

- (21) Recessive GT <sup>Ⓣ</sup><sub>2</sub> with local valuation window
- a. /<sup>Ⓣ</sup><sub>2</sub> + L-LL/ → \<sup>Ⓣ</sup>-<sup>Ⓣ</sup>L\  
 /<sup>Ⓣ</sup><sub>2</sub> + L-LH/ → \<sup>Ⓣ</sup>-LH\  
 b. /<sup>Ⓣ</sup><sub>2</sub> + L-HL/ → \L-HL\  
 /<sup>Ⓣ</sup><sub>2</sub> + L-HH/ → \L-HH\  
 (Note: In the original image, the L-LH target in (21a) and the L-HL, L-HH targets in (21b) are enclosed in dotted boxes, indicating they are unvalued.)

Further, figures illustrating valuation windows with valued and unvalued targets are below.



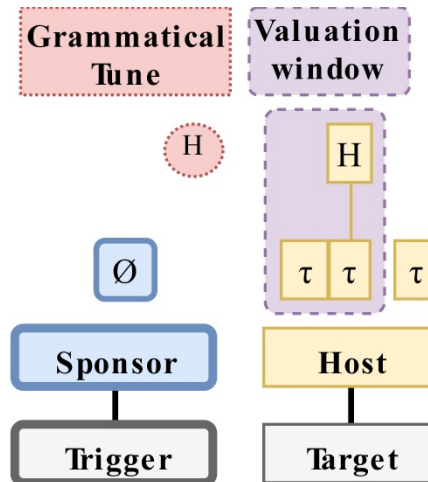

Figure 1: Recessive GT with local valuation window – *valued* target-host

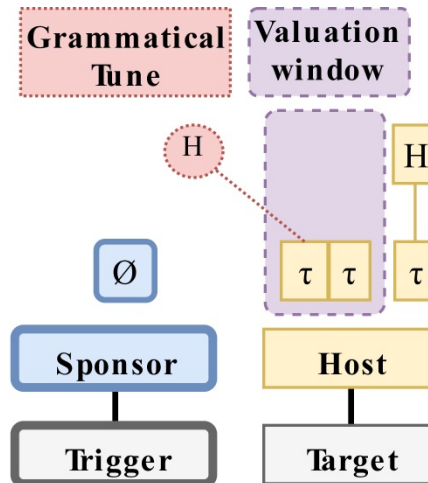

Figure 2: Recessive GT with local valuation window – *unvalued* target-host

Figure 1 illustrates that if a TBU  $\tau$  is valued with H within the valuation window, the floating  $\textcircled{H}$  grammatical tune does not dock to the target-host. In contrast, Figure 2 illustrates that if there is no valued TBU within the valuation window, the floating  $\textcircled{H}$  grammatical tune does dock, regardless of whether the target-host is valued *outside* of the valuation window. I return to valuation windows in section 3.3.6 below, where I discuss cases where the valuation windows appears to be a local adjacent morpheme ~ word ~ phonological constituent.

Finally, languages which have a high ‘tonal density’ with various toneme values do not show recessive GT (at least not straightforwardly). Languages have very high **tonal density** if the proportion of valued TBUs within the lexicon (i.e. /H/ vs. /L/) compared to unvalued TBUs (i.e.  $\emptyset$ ) is high (Gussenhoven 2001, 2004, Hyman 2009). This is common in those languages with multiple tone heights~contrasts such as Standard Chinese, Vietnamese, Thai, Yoruba, among others. Tone languages with high tonal density often have dominant/neutral GT systems, without recessive triggers. This can be attributed to the fact that if there are an insufficient number of unvalued morphemes then there may also be an insufficient number of unvalued target-hosts, which would be the only context where the tonological operation triggered by the recessive trigger would be seen. This will then lead to an unstable diachronic situation. In contrast, tonological operations with dominant and neutral triggers are observable with valued

(or unvalued) target-hosts. It should be emphasized, however, that there is nothing prohibiting the existence of recessive systems in ‘dense’ tone systems.<sup>4</sup>

### 3.1.4.2 Neutral-non-dominant

Finally, another non-dominant GT is called ‘neutral GT’. Unlike dominant GT and recessive GT, neutral GT is defined negatively:

- (22) **Neutral non-dominant GT:** the lack of automatic replacement/deletion of the underlying tone of the target-host or automatic non-application of the grammatical tune

With neutral GT, the ‘trigger’-sponsor concatenates with the target-host, and the result can be predicted based on the general phonological grammar. Some phonological grammars may allow both the underlying tone and grammatical tune to surface, while with other grammars one may delete due to general phonological markedness. In either case, the surface result is not inherently tied to the trigger (or any other component) of the GT, but rather emerges from other phonological constraints in the language. In other words, underlying tones of the target may delete for independent reasons (‘incidental neutralization’ in the terms of Hyman 2018a).

An example of neutral GT comes from Hausa [hau] (Chadic – Newman 1986). With so-called ‘tone non-integrating affixes’, Newman notes that ‘the stem preserves its lexical tone and the tone of the word is made up of the juxtaposition of the two tonally specified constituents (stem and affix)’. One example is the referential marker /-<sup>Ⓛ</sup>n/, shown below.

- (23) Neutral suffix /-<sup>Ⓛ</sup>n/
- |    |            |   |                   |   |               |             |                  |
|----|------------|---|-------------------|---|---------------|-------------|------------------|
| a. | /jààkíí    | + | - <sup>Ⓛ</sup> n/ | → | \jààkíìn \    | [jààkîn]    | ‘the donkey’     |
| b. | /sààtáccéé | + | - <sup>Ⓛ</sup> n/ | → | \sààtáccèèn \ | [sààtáccèn] | ‘the stolen one’ |
| c. | /zóómààyéé | + | - <sup>Ⓛ</sup> n/ | → | \zóómààyéèn \ | [zóómààyèn] | ‘the hares’      |
| d. | /hársúnàà  | + | - <sup>Ⓛ</sup> n/ | → | \hársúnààn \  | [hársúnàn]  | ‘the languages’  |
- [Hausa - Newman 1986:257]

Here the floating <sup>Ⓛ</sup> docks to the right edge of the tone and results in a contour falling tone if adjacent to an underlying high tone.

Most cases of what researchers refer to as ‘floating tones’ in the literature constitute examples of neutral GT. We saw one example from Igbo in chapter 2, repeated below.

<sup>4</sup> Yoruba [yor], in fact, demonstrates an OCP restriction akin to recessive GT. Clause final emphatic clitics consist solely of a copy of the last vowel with an inherent low tone (Akinlabi & Liberman 2000):

- |        |          |                     |                 |
|--------|----------|---------------------|-----------------|
| (i.)   | ó dé     | ‘he arrived’        |                 |
|        | ó dé è   | ‘he arrived’ (emph) |                 |
| (ii.)  | ó lḡ     | ‘he went’           |                 |
|        | ó lḡ ò   | ‘he went’ (emph)    |                 |
| (iii.) | ó sùn    | ‘he slept’          |                 |
|        | ó sùn ùn | ‘he slept’ (emph)   | (cf. *ó sùn ùn) |

In (i.)-(ii.), if these emphatic clitics appear after a [H] or [M] tone word, the clitic surfaces with its underlying /L/ tone. However, as shown in (iii.) if the clitic appears after a [L] tone word, the clitic surfaces with a [M] tone. Yoruba is not a privative system, but does show restricted instances of local culminativity, e.g. constraints against \*LL sequences here, with /ò/ the exclamatory/vocative particle, some possessive pronouns, as well as other types of OCP repairs with identical tonemes (see Akinlabi & Liberman 2000).

(24) Central Igbo: / àgbà + <sup>Ⓣ</sup> + èṅwè / → \ àgbà̄ èṅwè \ ‘jaw of monkey’

In Igbo dialects [igbo1259] (Hyman & Schuh 1974:98-9, Hyman 2011), two nouns in an associative construction are linked via a tonal morpheme, below represented as a floating tone <sup>Ⓣ</sup> between the nouns. In many cases, it will not be apparent without careful analysis whether a GT patterns is ‘neutral GT’ or dominant GT with a local valuation window.

As stated, with neutral-non-dominant GT the output will depend on the phonological grammar of the language. This is schematized in Table 6 with hypothetical data used for expository purposes.

		$\widehat{HM}$	*	$\widehat{HM}$	✓	$\widehat{HM}$	*
		$\widehat{MH}$	✓	$\widehat{MH}$	*	$\widehat{MH}$	*
		$\widehat{ML}$	*	$\widehat{ML}$	*	$\widehat{ML}$	✓
Neutral Trigger-sponsors	Targets	G1		G2		G3	
a.	/ kásā /	ná - kásā [nákásā]		ná - kásā [nákásā]		ná - kásā [nákásā]	
b.	/ ná- /	ná - gānā [nágānā]		ná - gānā [nágānā]		ná - gānā [nágānā]	
c.	/ hapa /	ná - hapa [náhàpà]		ná - hapa [náhàpà]		ná - hapa [náhàpà]	
d.	/ kásā /	má - <sup>Ⓜ</sup> kásā [mákásā]		mā <sup>Ⓜ</sup> - kásā [mākásā]		má - kásā [mákásā]	
e.	/ má <sup>Ⓜ</sup> - /	má - gānā [mágānā]		mā <sup>Ⓜ</sup> - gānā [mākānā]		má - <sup>Ⓜ</sup> gānā [mákānā]	
f.	/ hapa /	má - hā <sup>Ⓜ</sup> pā <sup>Ⓜ</sup> [máhāpā]		mā <sup>Ⓜ</sup> - hā <sup>Ⓜ</sup> pā <sup>Ⓜ</sup> [mākāpā]		má - hā <sup>Ⓜ</sup> pā <sup>Ⓜ</sup> [mákāpā]	

Table 6: Types of neutral grammars G1-G3

This table has a number of components. On the far left are neutral prefixes (in blue), which concatenate with the target-host lexical roots (in red). Row a.-c. show a prefix /ná-/ with no floating tone, while rows d.-f. has a floating <sup>Ⓜ</sup> tone. The targets either valued with underlying tone (/kásā/ in a.,d., /gānā/ in b.,e.) or are unvalued and toneless (/hapa/ in c.,f.).

The result of the concatenation of the prefix and target host can be predicted based on the phonological grammar. Three hypothetical grammars – G1, G2, and G3 – are presented at the top, which differ along three parameters: whether they allow (1) a [ $\widehat{HM}$ ] contour, (2) a [ $\widehat{MH}$ ] contour, and (3) a [ $\widehat{ML}$ ] contour. As seen in rows a.-c. with the prefix without floating tone, no change takes place from the input to output and all grammars are identical. Here, we can say that there is no grammatical tone.

In contrast, consider rows d.-f. Grammar G1 allows  $\widehat{MH}$  while grammars G2 and G3 do not. The result of this is distinct input to output mappings for the sequence / má<sup>Ⓜ</sup>- + kásā /: G1 [mákásā], G2 [mākásā], and G3 [mákásā]. Likewise, grammar G2 allows  $\widehat{HM}$  while grammar G3 allows  $\widehat{ML}$  while the other grammars do not, which results in distinct outputs. Row f. with the unvalued target-host shows that the floating mid tone docks to both TBUs without complication, and does not differentiate the three grammars.

### 3.1.5 Dominance schema

A schematic version of the types of GT are summarized in the tables below.

Target-host		Valued 1	Valued 2	Unvalued	Local valuation window	
					Valued	Unvalued
Trigger-sponsor		T T     τ τ	T   τ τ	τ τ	T T     τ τ	T   τ τ
Replacive-dominant	T <sup>⊕</sup>   τ	T ⊕   τ τ τ	T ⊕   τ τ τ	T ⊕   τ τ τ	T ⊕ T     τ τ τ	T ⊕ T     τ τ τ
Subtractive-dominant	T   τ	T   τ τ τ	T   τ τ τ	T   τ τ τ	T T     τ τ τ	T T     τ τ τ
Recessive	T <sup>⊕</sup>   τ	T T T       τ τ τ	T T T       τ τ τ	T ⊕   τ τ τ	T T T       τ τ τ	T ⊕ T     τ τ τ
Neutral	T <sup>⊕</sup>   τ	T ⊕ T T       τ τ τ	T ⊕ T     τ τ τ	T ⊕   τ τ τ	T ⊕ T T       τ τ τ	T ⊕ T     τ τ τ

Table 7: Types of GT triggers (expanded)

Target-host		Valued 1	Valued 2	Unvalued	Local valuation window	
					Valued	Unvalued
Replacive-dominant GT		a	a	a	b	b
Subtractive-dominant GT		c	c	c	d	d
Recessive-non-dominant GT		e	f	a	e	b
Neutral-non-dominant GT		g	b	a	g	b

Table 8: Types of GT triggers (patterns color-coded)

### 3.2 Limited role of phonological markedness and tonological naturalness

It is germane to our discussion here to establish the limited role which phonological markedness and tonological naturalness plays in the application of grammatical tone. In what follows, this section emphasizes that in the application of GT, the tonological process of tone deletion, addition, replacement, *etc.* is not attributed to a phonological repair in most cases, and is rarely phonologically optimizing in any consistent sense.

Like all phonological patterns, tonological operations can be assessed as to their **tonological naturalness**, which can be interpreted as a combination of straightforward phonetic foundation and typological frequency. Tonological naturalness is catalogued in detail in several works by Hyman (Hyman & Schuh 1974, Hyman 2007). Naturalness can be discussed in terms of operations such as vertical assimilation, horizontal assimilation, contour simplification via absorption or levelling, dissimilation, tonal copying, polarization, downstep, downdrift, low-raising, displacement, among others. In Table 13, natural and unnatural ‘tone rules’ are presented from Hyman (2007), e.g. showing in c. that progressive tonal absorption is more natural than regression absorption.

More natural				Less natural				
a.	LH vertical assimilation	/LH/	→	\LM\~ \MH\	HL vertical assimilation	/HL/	→	\HM\~ \ML\
b.	Perseverative horizontal assimilation	/LH/	→	\L\widehat{LH}	Anticipatory horizontal assimilation	/LH/	→	\widehat{LH}H\
c.	Progressive tonal absorption	/\widehat{HL}-L/	→	\H-L\	Regressive tonal absorption	/H-\widehat{HL}/	→	\H-L\

Table 9: Natural and unnatural tone rules (Hyman 2007)

Several other natural rules can be identified, such as ‘HL  $F_0$  polarization’ ( $\tau \grave{\tau} \rightarrow \check{\tau} \grave{\tau}$ ), ‘tone shift to a metrically strong position’ ( $H \emptyset \ ' \emptyset \emptyset \rightarrow \emptyset \emptyset \ ' H \emptyset$ ), ‘tonal anticipation’ ( $\emptyset H \rightarrow \widehat{H} H$ ). Tonological operations can be assessed with respect to sequences of tonemes, e.g. the ‘principle of ups and downs’ (Hyman 2007:16), minimizing the number of highs and lows in a sequence or the ‘no trough constraint’ (\*HLH). Several tonological hierarchies have also been introduced in the literature, e.g. toneme markedness ( $H > L > M$  in Yoruba - Pulleyblank 2004), contour markedness (RF, FR  $> R > F > H, L$ ), tone spreading naturalness ( $H \text{ spread} > L \text{ spread} > M \text{ spread}$ ), and the ‘hospitableness’ of a TBU (e.g.  $CVV > CV\text{Son} > CV\text{Obs} > CV$ ).

I bring up the breadth of tonological operations to highlight the fact that for the most part, they are orthogonal to grammatical tone assignment and do not play a role in determining the interaction between grammatical tone and underlying tones or trigger-sponsors and target-hosts. One way to understand this is that grammatical tone expresses meaning (the exponence function), and therefore the grammar has an imperative to preserve the grammatical tone (a faithfulness constraint) over any imperative to have a less marked structure (a markedness constraint). In short, morphology is separate from phonology and precedes it.

Consider the following data from Tommo So [dto]. In Tommo So, lexical verb tone is almost entirely predictable. Verbs which begin with a voiced obstruent appear with L(H) tone whereas verbs beginning with all other segments have H(H) tone, a type of depressor consonant effect. Tone on verbs is thus predictable for all but three segments ( $/n/$ ,  $/dʒ/ <j>$ , and  $/j/ <y>$ ) for which it must be underlyingly specified (McPherson 2013:87-89). We can understand this as a phonetically natural phonological constraint  $*D_{[+v]}\check{V}$ , saying that voiced obstruents followed by a high tone are marked. In grammatical context, verbs are subject to numerous grammatical tone overlays which are triggered by certain affixes and clitics. Crucially, the assignment of these patterns is *not* affected by this phonological constraint  $*D_{[+v]}\check{V}$ , as shown below with clitic  $/=be/$  ‘used to’ and the suffix  $/-d\grave{e}/$  IMPERFECTIVE, both assigning a HL pattern to targets with depressor consonants.

(25) Grammatical tone not sensitive to markedness

- a. HHH kílémó ‘play’ → [kílémó=be] ‘s/he used to play’
- LHH gòróló ‘snore’ → [gòróló=be] ‘s/he used to snore’
- b. HH ébé ‘buy’ → [ébé-dè] ‘(s/he) buys/will buy’
- LH dʒòbó ‘run’ → [dʒòbò-dè] ‘(s/he) runs/will run’

[Tommo So – McPherson 2013:283]

Schuh (2017:103-117) discusses something similar in Zaar [say] (Chadic), data coming largely from Schneeberg (1974) and Caron (2005). There exist a complex set of phonologically general tonological operations involving depressor consonants, e.g. [-High] tonemes are realized as [L] in certain depressor contexts, e.g.  $/\text{ʒòngà}/$  /LL/ [ʒòngà] [LL] ‘brains’ vs.  $/\text{mīr}/$  /L/ [mīr]

[M] ‘oil’. I refer the reader to Schuh for a complete analysis; for our purposes, the most important aspect is the following:

*“In the verbal system, morphological and syntactic factors systematically override phonological factors in determining tone. Schneeberg (1974:159ff.) discusses this in some detail in a section called ‘Grammatical Tone’.”*

[Zaar – Schuh 2017:114]

Verbs can be divided into tonal classes, whose tone properties are largely grammatically determined. For example, consider verbs in the mid tone /M/ class, in which all verbs ‘have the same tones regardless of initial consonant type’, e.g. *dětsó* ‘sneeze’. In context, the initial syllable of the verb can bear [H], [M], or [L] tone depending on the grammatical context, showing no depressor restrictions prevalent in other parts of the language. Phonologically marked sequences [dé] are in bold and boxed below.

(26)		1 <sup>ST</sup> SINGULAR	1 <sup>ST</sup> PLURAL	
a.	PERFECTIVE	[máá <b>dětsó</b> ]	[màà <b>dětsó</b> ]	‘I/we sneezed’
b.	REMOTE	[mā́tá <b>dětsó</b> ]	[màtá <b>dětsó</b> ]	‘I/we sneezed some time ago’
c.	SUBJUNCTIVE	[mè <b>dětsó</b> ]	[mè <b>dětsó</b> ]	‘that I/we sneeze’
d.	AORIST	[mē <b>dětsó</b> ]	[mē <b>dětsó</b> ]	‘and I/we sneezed’

[Zaar – Schuh 2017:115]

Schuh presents a partial analysis of these data involving grammatically assigned tones, but ultimately says:

*“I have no solution to this problem that doesn’t involve handwaving. The main point, however, is that these verbal constructions make a number of grammatical uses of tone that involve lexical contrasts (H vs. L in subject agreement) and morphosyntactic marking (TAM marking by tone) that do not have phonological explanations.”*

[Zaar – Schuh 2017:116]

We can compare this to several cases of **phonologically general** H tone spreading which is not GT and is blocked by depressor consonants. Two clear cases are Dagara [dgɪ] (Lee 2009) and Bole [boɪ] (Schuh 2017, citing Lukas 1969, Gimba 1998, Schuh & Gimba 2005). Lee shows that in the Wule dialect of Dagara, H tone spreads onto the following word (27)a., but is blocked by voiced obstruents (b.). This is a classic derived-environment effect in that H tone can appear adjacent to depressor consonants in underlying representations, e.g. /zú/ ‘steal’.

(27)	Blocking of phonologically-general high tone spread by depressor consonants			
a.	/ní/ ‘person’ + /kòglá/ ‘accompany’	→	\ ní <b>kò</b> glá \	‘a person to be accompanied’
b.	/ní/ ‘person’ + /zèlá/ ‘ask’	→	\ ní <b>zè</b> lá \	‘a person to be asked’

[Dagara – Lee 2009]

Similarly, Schuh (2017:128) shows that Bole has a rule of ‘high tone spreading’ across words which affects a L tone. This can spread onto a non-depressor consonant as in (28)a., but cannot spread onto a depressor consonant, in b.<sup>5</sup>

<sup>5</sup> Schuh notes that H tone spreading is constrained by syntax in that [ VERB + OBJECT ] constructions allow it, but [ SUBJECT + VERB ] or [ NOUN + ADJECTIVE/NUMERAL ] do not, and further that proper names as a whole neither

(28) Blocking of phonologically-general high tone spread by depressor consonants

- |    |                       |                          |                                  |
|----|-----------------------|--------------------------|----------------------------------|
| a. | /pòtí/ ‘sun’          | \ rùní <b>p</b> ótí \    | ‘shade from the sun’             |
|    | /bàadí/ ‘knife’       | \ shòowí <b>b</b> áadí \ | ‘handle of a knife’              |
|    | /ngùukà/ ‘hernia’     | \ sèedí <b>ng</b> úukà \ | ‘remedy for a hernia’            |
|    | /làawò/ ‘child’       | \ dóoshó <b>l</b> áawò \ | ‘horse of a child’               |
| b. | /bidò/ ‘monkey’       | \ ló <b>b</b> ìdò \      | ‘meat of a monkey’               |
|    | /zòngè/ ‘desert date’ | \ àttí <b>z</b> òngè \   | ‘ <i>kunu</i> from desert dates’ |

[Bole – Schuh 2017:128]

These data highlight the fact that H tone as part of a grammatical tune is a morphological exponent, or restricted in such a way as to be a cue for a particular grammatical meaning. It would therefore be more ‘costly’ to not realize the grammatical tune H on the target-host, as it is meaningful for the linguistic utterance and would more likely affect information transference. In contrast, the non-application of phonologically general H tone spread is less ‘costly’ for information transference, and can be suspended more easily to avoid marked structures.

We can plot tonal processes along two axes to illustrate the orthogonality of grammatical tone and phonological markedness. The Yoruba case from chapter 1 (the first example) involved the spreading of H and L tonemes one TBU to the right creating a contour, i.e. /H L/ → \H HL\ . This is tonologically natural, but not grammatically conditioned. Further, in Jita a conspiracy is found to avoid a [HH] sequence (an OCP violation). Meeussen’s Rule (/H<sub>1</sub>H<sub>2</sub>/ → \H<sub>1</sub>Ø\ ) applies between an object marker and verb root, but tonal defenestration (section 3.3.3.4 below) applies between two object markers (/H<sub>1</sub>H<sub>2</sub>/ → \H<sub>1</sub>Ø...H<sub>2</sub>\ ). In each of these cases the output is less marked than the input. Thus it is tonologically natural, but also grammatically conditioned.

Further, some of the most ‘unnatural’ tonological rules involve largescale tone circles. Here, tonal input-to-output mappings form a complex set of changes depending on the input tones, which are both difficult to generalize over and recalcitrant to motivation though phonological naturalness. One famous case is Southern Min varieties of Chinese (Min Nan) [nan] such as the Xiamen tone circle (Chen 2000:42-45,82-83), which is neither functionally motivated or phonetically driven (Chen 2000:83). The underlying form to Sandhi form mappings are given below, as from Chen.

- (29) Xiaman tone circle  
{44,24} → 22 → 21 → 53 → 44

The application of tone sandhi is not conditioned by a natural class of morphosyntactic morphemes or constructions, and as such does not represent grammatical tone. In this way, we can say it is neither grammatically conditioned nor tonologically natural.

Several other tone ‘circles’ have recently been described, some of which *are* clearly grammatically conditioned. One such case is the ‘nominalizer tone circle’ in the Cushillococha dialect of Ticuna [tca] (Skilton 2017:47-56). Ticuna likely has the largest inventory of tonemes in South America, consisting of the following (where 5 = highest pitch, 1 = lowest): /5/, /4/, /3/, /2/, /1/, /51/, /43/, /31/ (and creaky /1/). These are written as superscripted after the TBU. Skilton describes a set of productive ‘class nominalizers’ which derive nouns and are split into distinct morphological classes, which she calls I-IV: /-(?)e<sup>3</sup>/ CLASS.I.NMLZ, /-(?)ki<sup>3</sup>/ CLASS.II.NMLZ, /-ʔ<sup>5</sup>ne<sup>1</sup>/ CLASS.III.NMLZ, and /-ʔ<sup>4</sup>/ CLASS.IV.NMLZ. All class nominalizers “trigger the

---

trigger it nor undergo it. From this statement, I suspect that H tone spreading is restricted to particular *prosodic* domains, and thus does not constitute GT.

nominalizer tone circle, a set of tonal alternations affecting the last syllable of the verb stem that bears the nominalizer” with “...the same alternations appear[ing] whether the final syllable belongs to the verb root, an incorporate, or a verbal suffix or enclitic” (p. 48).

The result is a complex set of grammatically conditioned alternations given in Figure 3.

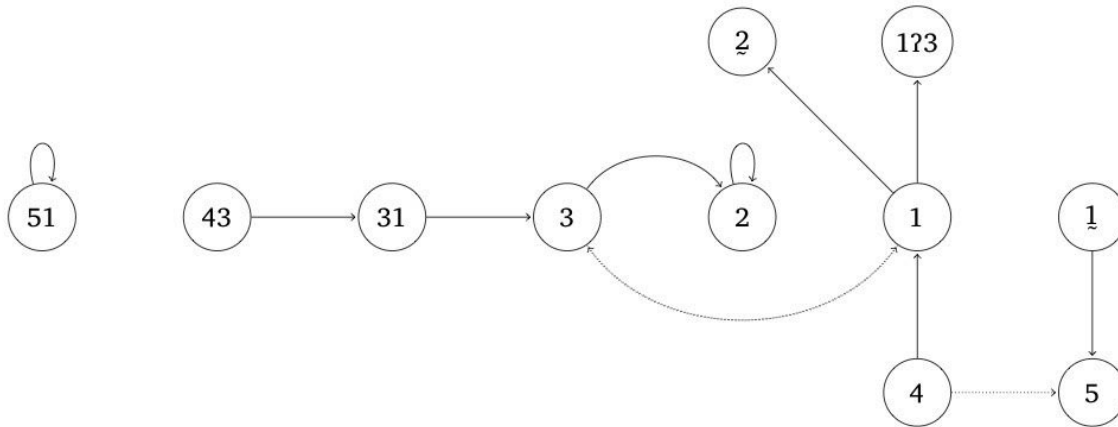

Figure 3: Ticuna nominalizer tone circle (Skilton p.c., updating diagram in Skilton 2017:55) [Solid lines are changes in stressed syllables, dotted lines are changes in unstressed syllables]

The input-to-output mapping depends on the input tone of the target TBU, whether the target TBU is stressed, whether the target TBU has creaky voice, and in a small corner of the grammar, morphological properties of the nominalizer trigger itself. This Ticuna pattern is tonologically unnatural and grammatically conditioned.<sup>6</sup>

This is summarized in Figure 4 below.

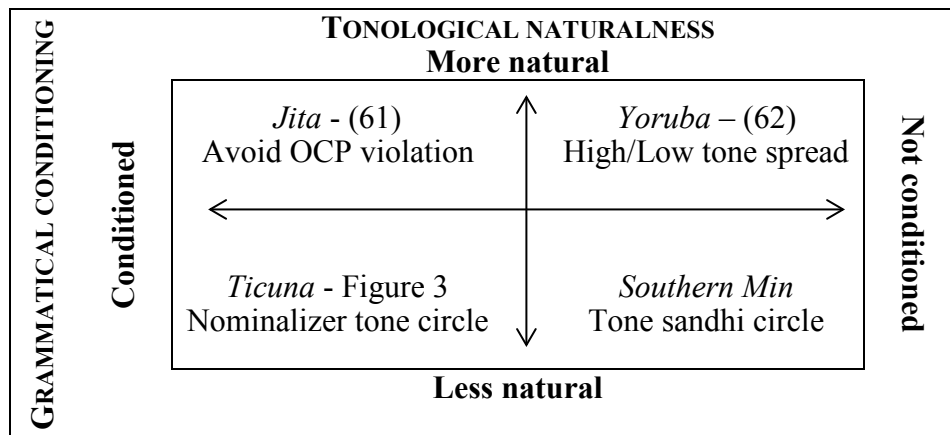

Figure 4: Orthogonality of grammatical conditioning and tonological naturalness

In total, there is no tendency for the output of the interaction of grammatical tone to be more ‘natural’ or less ‘natural’ compared to the input, or compared to any cross-linguistic tendencies. In fact, across African languages it is frequently the case that a marked tonal pattern *only* surfaces via grammatical tone. In Fe’fe’-Bamileke [fmp] the H toneme (unlike M and L) is

<sup>6</sup> Several other tonal chain shifts are provided in Mortensen (2006), many of which are not phonetically grounded.



restricted to grammatical processes and morphemes (e.g. demonstratives, subjunctive marker, the numeral /púá/ ‘two’). For example, when two M tone nouns occur in a genitive construction, the first M becomes H: *thū* ‘head’ + *mūū* ‘child’ → *thū mūū* ‘head of child’. Similarly, certain tonal sequences are only seen in grammatical contexts, e.g. in Kukuya [kkw] (Bantu - Paulian 1975) a L tone verb acquires a LHL melody in the present tense (e.g. *ndé bāámì* ‘he wakes up’). Parallel examples are found in Tommo So discussed above, and Esan [ish] (Edoid, Benue-Congo – author fieldnotes). Tommo So bans nouns with an all underlying L sequence and Esan bans nouns with an all underlying H sequence, but both patterns in their respective languages occur frequently on the surface due to GT.

### 3.3 GT dominance effects in action

#### 3.3.1 Typology of interacting triggers

Here, I will discuss the typology which emerges when we look at the interaction of dominant, recessive, and neutral triggers within a derivation. We have attributed dominance behavior to a lexical idiosyncrasy which must be encoded within the trigger itself. As this is encoded within the morpheme/construction, by default we expect the behavior of the trigger to be uniform regardless of what the target-host is. That is, a trigger should behave the same whether the target is **simplex** consisting of a single morpheme such as a root, or **complex** consisting of more than one morpheme~word~constituent such as a stem, derived word, or multi-word phrase. In this way, dominance behavior is not conditioned by its phonological, morphological, or syntactic environment (or any other environment), but rather is a property encoded within the lexical representation of the morpheme itself (or construction – if those are permitted to be represented).

I illustrate this schematically in (30)-(33), which show that when there are two triggers within a relevant domain, the outer trigger will dictate the surface result. This largely assumes a classic cyclic model in which the tonological operation triggered by the inner trigger will take place before that of the outer trigger. This is formalized and defended in chapter 6. Abbreviations to understand this schema are the following: H = Unvalued Host, H̄ = Valued Host, D = Dominant (additive-dominant for our purposes here), R = Recessive, N = Neutral; any value X̄ with an accent triggers a grammatically-conditioned tonological operation (i.e. GT).

#### (30) Simplex target: Host + single trigger

	Unvalued		Valued
a.	/H-D̄/ → H-D̄	/	/H̄-D̄/ → H̄-D̄
b.	/H-R̄/ → H-R̄	/	/H̄-R̄/ → H̄-R̄
c.	/H-N̄/ → H-N̄	/	/H̄-N̄/ → H̄-N̄

#### (31) Complex target: Host + two triggers where outer is dominant

	Unvalued		Valued
a.	/H-D̄-D̄/ → H-D-D̄	/	/H̄-D̄-D̄/ → H̄-D-D̄
b.	/H-R̄-D̄/ → H-R-D̄	/	/H̄-R̄-D̄/ → H̄-R-D̄
c.	/H-N̄-D̄/ → H-N-D̄	/	/H̄-N̄-D̄/ → H̄-N-D̄

#### (32) Complex target: Host + two triggers where outer is recessive

	Unvalued		Valued
a.	/H-D̄-R̄/ → H-D̄-R̄	/	/H̄-D̄-R̄/ → H̄-D̄-R̄
b.	/H-R̄-R̄/ → H-R̄-R̄	/	/H̄-R̄-R̄/ → H̄-R̄-R̄
c.	/H-N̄-R̄/ → H-N̄-R̄	/	/H̄-N̄-R̄/ → H̄-N̄-R̄

(33) **Complex target:** Host + two triggers where outer is **neutral**

	Unvalued		Valued
a.	/ H- $\acute{D}$ - $\acute{N}$ /	→	H- $\boxed{\acute{D}}$ - $\acute{N}$ / → H- $\boxed{\acute{D}}$ - $\acute{N}$
b.	/ H- $\acute{R}$ - $\acute{N}$ /	→	H- $\boxed{\acute{R}}$ - $\acute{N}$ / → $\boxed{\acute{H}}$ - $\acute{R}$ - $\acute{N}$
c.	/ H- $\acute{N}$ - $\acute{N}$ /	→	H- $\boxed{\acute{N}}$ - $\acute{N}$ / → $\boxed{\acute{H}}$ - $\boxed{\acute{N}}$ - $\acute{N}$

With the simplex target, the output with valued targets depends on the trigger in ways outlined already. Let's examine the complex targets in the other examples. If the outer trigger is dominant as in (31), it is predicted that the outer dominant trigger will always impose its pattern regardless of its target, as indicated by all sub-examples here showing  $\acute{D}$  boxed and in bold. In (32) where the outer trigger is recessive, this is predicted to never impose its pattern in these contexts (it would only impose its pattern if both the inner affix and root were unvalued). Finally, the neutral outer trigger is expected to impose but not override any input value.

In the GT literature, cases of outer dominance winning over more than one morpheme regardless of the content of inner morphemes are prevalent. The first example in (34) is from the Gbarain dialect of Izon [*ijc*] (Ijoid – author fieldnotes).

(34) **Outer dominance (over inner dominance)**

a.	/ $\acute{D}_1$ + $\acute{H}$ /	→	$\acute{D}_1$ H	
	/ $\text{\textcircled{L}}\text{\textcircled{H}}_A$ + $\text{\textcircled{L}}_C$ /	→	$\text{\textcircled{L}}\text{\textcircled{H}}$ $\boxed{\text{\textcircled{w}}\text{\textcircled{a}}\text{\textcircled{r}}\text{\textcircled{i}}$	( surface: [òpù wàrí]~[òpù wàrí] )
	big + house	→	'big house'	
b.	/ $D_2$ + [ $\acute{D}_1$ + $\acute{H}$ ] /	→	$\acute{D}_2$ [ $D_1$ H ]	
	/ $\text{\textcircled{H}}_A$ + [ $\text{\textcircled{L}}\text{\textcircled{H}}_A$ + $\text{\textcircled{L}}_C$ ] /	→	inè [ $\text{\textcircled{H}}$ $\boxed{\text{\textcircled{p}}\text{\textcircled{u}}$ $\boxed{\text{\textcircled{w}}\text{\textcircled{a}}\text{\textcircled{r}}\text{\textcircled{i}}$ ]	
	my + big + house	→	'my big house'	

[Gbarain Izon – author fieldnotes]

In (a), the dominant trigger / $\text{\textcircled{L}}\text{\textcircled{H}}$ / 'big' assigns a LH melody to the target-host whose tones are deleted. In (b), the outer dominant trigger /inè<sup>H</sup>/ 'my' assigns a H melody to the target-host which consists of the inner trigger its target-host. Both of their tones are overridden as expected. In this case, we can say that GT **scopes** over both morphemes and that they both constitute the target.

An analogous case is in (35) from Jamsay [*djm*] (Dogon – McPherson & Heath 2016):

(35) **Outer dominance (over inner dominance)**

a.	/ $\acute{D}_1$	+ $\acute{H}$ /	→	$\acute{D}_1$	H
	/ PossINonP <sup>H</sup> <sub>L</sub>	+ N/	→	T	<sup>H</sup> <sub>L</sub>
	/ Sáydù	+ lèjú /	→	Sáydù	$\boxed{\text{\textcircled{l}}\text{\textcircled{e}}\text{\textcircled{j}}\text{\textcircled{u}}}$
	Seydou	+ uncle	→	'Seydou's uncle'	
b.	/ [ $\acute{D}_1$	+ $\acute{H}$ ]	+ $\acute{D}_2$ /	→	[ $D_1$ H ] $\acute{D}_2$
	/ [ PossINonP <sup>H</sup> <sub>L</sub> +	N ]	+ <sup>L</sup> Adj/	→	[ <sup>L</sup> ] T
	/ [ Sáydù	+ lèjú ]	+ m̀ǹjú /	→	$\boxed{\text{\textcircled{S}}\text{\textcircled{a}}\text{\textcircled{y}}\text{\textcircled{d}}\text{\textcircled{u}}$ $\boxed{\text{\textcircled{l}}\text{\textcircled{e}}\text{\textcircled{j}}\text{\textcircled{u}}}$ m̀ǹjú
	Seydou	+ uncle	+ ugly	→	'Seydou's ugly uncle'

[Jamsay – McPherson & Heath 2016]

In this case, the outer dominant (the adjective /m̀ǹjú/ 'ugly') is at the end of the constituent and scopes over both the possessor and the noun, both constituting the target. In Jamsay, adjectives as a class are dominant and trigger L tone GT on the target. These data show that the effect of outer dominance cannot be merely attributed to a directionality effect where the leftmost tone wins (i.e. 'directional resolution').

Similarly, outer recessive triggers will be recessive to all valued target-hosts, regardless of where their valuation is sponsored from, and the same logic applies to neutral triggers as well. Inkelas (1998) exemplifies this for Sanskrit in (36), which although not tonal shows a privative-culminative accent system and therefore suffices.

- (36) Outer recessive trigger *-é* dative singular
- |    |            |                     |                          |             |                    |
|----|------------|---------------------|--------------------------|-------------|--------------------|
| a. | Unvalued   | / duhitar + -é /    | → \ duhitar- <u>é</u> \  | [duhitré]   | ‘daughter (dat)’   |
| b. | Valued     | / bhrá:tr + -é /    | → \ <u>bhrá:</u> tar-e \ | [bhrá:tare] | ‘brother (dat)’    |
| c. | Inner Dom. | / [ rath-ín ] + é / | → \ rath <u>ín</u> -e \  | [rathíne]   | ‘charioteer’ (dat) |
- [Sanskrit – Inkelas 1998]

Here, as expected, the outer recessive trigger */-é/* is recessive to root accent (a.-b.) as well as to accent on an inner dominant suffix */-ín/* (c.).

Inkelas (1998) shows how dominant and neutral triggers in Hausa can be interleaved in morphologically complex words, resulting in ‘layers’ of GT. The dominant affixes *-íí* AGENT and *-iyáá* FEM replace any tones present and assign a L and H melody respectively, while non-dominant triggers *má-* NOMINALIZER and *-r* REF either assign no tone, or assign a floating tone which docks to the edge but does not replace tones.

- (37) Outer neutral trigger
- |    |  |                                    |           |                                    |  |
|----|--|------------------------------------|-----------|------------------------------------|--|
| a. | <i>makañanciyâr</i> ‘the reader (female)’ (well-read person, usually w.r.t. the Koran) |                                    |           |                                    |  |
| b. | Cycles   |                                    |           |                                    |  |
|    | Dom  | / kàràntá: - <sup>L</sup> íí /     | →         | \ <u>kàràncí</u> \                 |  |
|    | Non-dom  | / má- kàràncí /                    | →         | \ <u>má</u> kàràncí \              |  |
|    | Dom  | / mákàràncí - <sup>H</sup> iyáá /  | →         | \ <u>má</u> kàràncí <u>iyáá</u> \  |  |
|    | Non-dom  | / mákàràncíiyáá - <sup>L</sup> r / | →         | \ mákàràncí <u>iyáá</u> <u>r</u> \ |  |
| c. | [ [ [  | má-                                | [ kàràntá | - <sup>L</sup> íí ] ]              | - <sup>H</sup> iyáá ] - <sup>L</sup> r ] |
|    |  | NML-                               | read      | -AGENT                             | -FEM -REF                                |
|    |  | NEUT                               | ROOT      | DOM                                | DOM NEUT                                 |
- [Hausa – Inkelas 1998:132]

I attribute these facts to an **outer dominance principle**, which states that properties of triggers (e.g. whether dominant, recessive, or neutral) are maintained regardless of the content of the target. I use certain symbol conventions to facilitate discussion here:

- (38) Symbols used in illustrating dominance effects
- |    |   |              |      |  |
|----|---|--------------|------|--|
| a. | ► | Dominant     | e.g. | x ► y, means ‘x is dominant over y’                |
| b. | ≡ | Non-dominant | e.g. | x ≡ y, means ‘x is not dominant with respect to y’ |

[Def 5] **Outer dominance principle:**

- a. Given a trigger  $X_1$  and a target-host where H
  - i.  $X_{1a}$  ► H
  - ii.  $X_{1b}$  ≡ H
- b. and, Given a trigger  $X_2$  and a target-host where H
  - i.  $X_{2a}$  ► H
  - ii.  $X_{2b}$  ≡ H
- c. If  $X_2$  is outwardly located relative to  $X_1$
- d. Then
  - i.  $X_{2a}$  ►  $X_{1a/b}$
  - ii.  $X_{2b}$  ≡  $X_{1a/b}$

Conceptually, this does not have to be the case. An alternative would be that the dominance effect by default is conditioned equally from the trigger-sponsor and target-host. Additionally, an inner dominant could override the properties of an outer non-dominant trigger as well, and not just ‘inner’ material. Such cases will be discussed in this study as they come up, but they are without question the exception rather than the rule.

### 3.3.2 *GT indomitability – An overview of non-undergoing exceptional targets*

In this section, I illustrate cases in which a trigger conditions a tonological operation but a minority of targets are exceptional and do not undergo the tonological operation, i.e. they exceptionally reject a grammatical tune docking to it. I refer to this as **GT indomitability**, a type of immutability effect in which structure does not undergo (morpho)phonological changes as expected.

[Def 6] **GT indomitability**: The exceptional behavior of certain GT targets which fail to undergo a tonological operation, despite their being a target of the trigger

Conceptually, targets may be indomitable to any type of triggers, whether dominant, recessive, or neutral. Indomitable targets with dominant triggers may be valued or unvalued, shown in (39)b and c. (indomitable targets are in bold and boxed). Here, non-exceptional target-hosts undergo the tonological operation, where their underlying tones are replaced by the floating  $\textcircled{H}$ , whereas exceptional target-hosts do not and retain their underlying value or remain unvalued. The same patterns are seen in neutral indomitability in (40). For recessive indomitability in (41), only indomitable unvalued targets are possible.

(39)	Dominant indomitability			
a.	Non-exceptional target	/ LM / <sub>1</sub> + / $\textcircled{H}$ L /	→	\ $\textcircled{H}\textcircled{H}$ -L \
b.	Indomitable valued target	/ LM / <sub>2</sub> + / $\textcircled{H}$ L /	→	\ <b>LM</b> -L \
c.	Indomitable unvalued target	/ $\emptyset\emptyset$ / <sub>3</sub> + / $\textcircled{H}$ L /	→	\ <b><math>\emptyset\emptyset</math></b> -L \
(40)	Neutral indomitability			
a.	Non-exceptional target	/ LM / <sub>1</sub> + / $\textcircled{H}$ L /	→	\ LM $\textcircled{H}$ -L \
b.	Indomitable valued target	/ LM / <sub>2</sub> + / $\textcircled{H}$ L /	→	\ <b>LM</b> -L \
c.	Indomitable unvalued target	/ $\emptyset\emptyset$ / <sub>3</sub> + / $\textcircled{H}$ L /	→	\ <b><math>\emptyset\emptyset</math></b> -L \
(41)	Recessive indomitability			
a.	Non-exceptional target	/ $\emptyset\emptyset$ / <sub>1</sub> + / $\textcircled{H}$ /	→	\ $\textcircled{H}\textcircled{H}$ \
b.	Indomitable unvalued target	/ $\emptyset\emptyset$ / <sub>2</sub> + / $\textcircled{H}$ /	→	\ <b><math>\emptyset\emptyset</math></b> \

One of the central observations of indomitable structures is that phonological markedness does *not* play a role in most cases of indomitability. In other words, the reason that the grammatical tune does not dock is *not* because it would create a marked phonological structure (see discussion also in section 3.2 above).

I highlight several types of indomitability below, based on the unifying characteristic of the non-undergoing target. One type is **morphemic indomitability**, where certain morphemes fail to undergo the GT operation. This may be an individual morpheme, or a class of morphemes such as a lexical stratum consisting of loanwords within a lexicon. Consider the Jita data below [jit] (Bantu – Downing 2014). The negative marker /-tá/ NEG has an inherent underlying high tone seen in (42)a. Recall that Jita displays high tone rightward shift where the output tone shifts one TBU to the right on the surface, shown in the [ ] surface form. When /-tá/ appears immediately before a high tone, Meeussen’s Rule applies (/HH/ → \HØ\ ) shown in b. where the H on the verb

is deleted, and c. where H on the object marker /-βá/ is deleted. In contrast, when /-tá/ precede the negative distant future prefix /-lí/ NEG.DIST.FUT with underlying H tone, the H on /-lí/ is not subject to tone delete, unlike in these other contexts. This is shown in d.

(42) Morphemic indomitability

- |    |  |   |  |      |  |
|----|--|---|--|------|--|
| a. | / a-tá-a-geenda /<br>/ 3SG-NEG-TODAY.PAST-go /<br>'s/he didn't go'                     | → | \ a- <b>tá-a</b> -geenda \<br>[ataagéenda]               |      |  |
| b. | / a-tá-a-síriisya /<br>3SG-NEG-TODAY.PAST-burn<br>'s/he didn't burn'                   | → | \ a- <b>tá-a</b> - <b>sí</b> riisya \<br>[ataasíriisya]  | (cf. | <sup>x</sup> \ a- <b>ta-a</b> - <b>sí</b> riisya \<br>( <sup>x</sup> [ataasíriisya]  |
| c. | / a-tá-a-βá-saanga /<br>3SG-NEG-TODAY.PAST-CL2-meet<br>'s/he did not meet them (cl.2)' | → | \ a- <b>tá-a</b> - <b>βa</b> -saanga \<br>[ataaβásaanga] | (cf. | <sup>x</sup> \ a- <b>ta-a</b> - <b>βá</b> -saanga \<br>( <sup>x</sup> [ataaβasáanga] |
| d. | / a-tá-lí-sakira /<br>3SG-NEG-NEG.DIST.FUT-help<br>'s/he will not help'                | → | \ a- <b>ta</b> - <b>lí</b> -sakira \<br>[atalísakira]    | (cf. | <sup>x</sup> \ a- <b>tá</b> - <b>lí</b> -sakira \<br>( <sup>x</sup> [atalísakira]    |

[Jita – Downing 1996, 2014]

We may call the morpheme /-lí/ in this case indomitable.

Further, it is not clear whether morphemic indomitability exists which involves entire classes of nouns, e.g. an entire lexical stratum. This is even more surprising given several empirically attested cases with other morphophonological operations. Consider data from stress/accent language Yakima Sahaptin [yak] with culminativity, detailed in Hargus & Beavert (2006). In this language, there is a contrast between accented roots such as /ʔatí'áwi/ 'beg' which lose underlying accent in the context of an accented prefix (e.g. /pá-/ 'inverse') versus 'strong' roots such as /ʔiwáxi/ 'wait' which does not lose accent (the 'strong' root class is not numerous – list on p. 180-181). They provide the following hierarchy to describe conflict resolutions in accent assignment: suffixes > 'strong' roots > prefixes > roots.

(43)

- |    |   |    |                      |
|----|---|----|----------------------|
| a. | Normal root: prefixal accent ► root accent<br>/ pá- ʔatí'áwi -ʃa /<br>INVERSE-beg-IMPERFECTIVE 'he's begging him' | ▶  | [pá]ʔatí'awíʃa]      |
| b. | 'Strong' root: prefixal accent ◄► root accent<br>/ pá- ʔiwáxi -m /<br>INVERSE-wait-CISLOCATIVE 'wait for me'      | ◄► | [paʔi <b>wá</b> xim] |

[Yakima Sahaptin – Hargus & Beavert 2006]

In terms of the present typology, one interpretation of these data is that 'strong' roots are an indomitable lexical class.

One area where we might expect widespread indomitability is in loanwords, as has been shown for other morphophonological phenomena. For example, Chudak (2010) shows that the application of consonant mutation on loanwords in Irish is shown to depend on the generation, dialect, period of borrowing of the loanword, and the initial segment of the borrowed word itself. It therefore comes as a surprise that cases which illustrate loanword GT indomitability are not found in any straightforward manner in my survey.

In contrast, other types of indomitability are common. One is what I term **morphosyntactic indomitability**, in which certain morphological or syntactic constituents fail to undergo a GT operation. One type is morphosyntactic indomitability with a **transparent** target, which does not

block the application of the grammatical tune to dock to a different host. This was seen above in Tommo So, partially repeated below in (44). In Tommo So [dto] (Dogon), the demonstrative /nó/ ‘this’ is a dominant trigger which assigns L tone, seen in a-b where the underlying /H/ tones of the target are deleted. In contrast, example c. shows it is not dominant over an alienable possessor /m̄m̄o/ 1SG.POSS which the grammatical tune cannot affect. Because this is the case for the natural class ‘alienable possessors’ (nominal or pronominal), we can consider this morphosyntactically defined indomitability. Note that in c. the grammatical tune does dock to the head noun ‘cat’, showing that this is a transparent target. Note that there is variation as shown in d., in which the alienable possessor may variably be opaque and cause self-docking of the grammatical tune onto the trigger.

(44) Morphosyntactic indomitability

- |    |                        |   |                       |
|----|------------------------|---|-----------------------|
| a. | / gámmá + nó /         | → | <u>gámmà</u> nó       |
|    | cat this               |   | ‘this cat’            |
| b. | / gámmá + gém + nó /   | → | <u>gámmà gèm</u> nó   |
|    | cat black this         |   | ‘this black cat’      |
| c. | / gámmá + m̄m̄o + nó / | → | <u>gámmà</u> m̄m̄o nó |
|    | cat 1SG.POSS this      |   | ‘this cat of mine’    |
| d. | / gámmá + m̄m̄o + nó / | → | gámmá m̄m̄o <u>n̄</u> |
|    | cat 1SG.POSS this      |   | ‘this cat of mine’    |

[Tommo So – McPherson & Heath 2016]

More common are cases in which the indomitable target is **opaque**, and is itself either a GT trigger, valued, or both. A case can be found also in the Dogon family, from Ben Tey [dbt]. Such cases are referred to as ‘hierarchical reversals’ in McPherson & Heath (2016). As with Tommo So, demonstratives in Ben Tey are dominant triggers which assign L tone to the target, as in (45)a. Also as with Tommo So, alienable possessors are dominant triggers, as seen in b. where the possessor assigns a HL grammatical tune to the noun. This example shows that when both triggers co-occur – the inner trigger (possessor) and the outer trigger (demonstrative) – it is the *inner* trigger whose grammatical tune surfaces and blocks the application of the grammatical tune to both itself and to the head noun. Therefore, in b. the output tones on the noun are the  $\backslash\textcircled{H}\textcircled{L}\backslash$  tune from the inner trigger, rather than a uniform  $\textcircled{L}$  tune from the outer trigger. This shows that not only is the possessor indomitable, but the entire constituent possessor phrase (PossP) which includes the noun is indomitable.

(45)

- |    |  |   |                                      |
|----|--|---|--------------------------------------|
| a. | / injě + $\textcircled{L}$ mùú /   | → | <u>injě</u> mùú                      |
|    | dog this.AN.SG   |   | ‘this dog’                           |
| b. | / [ yă-m $\textcircled{H}\textcircled{L}$ + injě ] + $\textcircled{L}$ mùú / | → | [ yă-m <u>injě</u> ] mùú             |
|    | woman-AN.SG dog this.AN.SG   |   | ‘this dog of (belonging to) a woman’ |

[Ben Tey – McPherson & Heath 2016:618-619]<sup>7</sup>

Indomitable structures can be seen with both dominant and non-dominant triggers in Makonde [kde] (Bantu) in the table below, whose dialect Chinnima is described in Kraal (2005).

<sup>7</sup> Note that that for /injě-m/ ‘dog-AN.SG’, the animate singular suffix on the noun is lost in modified contexts (McPherson & Heath 2016:618,fn22).

Tone Class	≈ / Underlying / [ Citation ]	1	2	3
		Possessive pronoun / + ττ /	/ + °a-PPx-nó / DEM ‘this X’	/ + ntwáani / ‘what kind of X?’
A	/ chitúví / [ chitúúví ] ‘bundle’	chi <u>túví</u> cha <u>á</u> ngu ‘my bundle’	chi <u>túví áchíí</u> no	chitu <u>ví</u> ntwáani
B	/ litáwa / [ litáàwà ] ‘clan’	li <u>táwá</u> lye <u>é</u> tu ‘our clan’	li <u>táwá álíí</u> no	lita <u>wá</u> ntwáani
C1	/ lutaví / [ lùtáávi ] ‘branch’	luta <u>ví</u> lwa <u>á</u> ke ‘his branch’	lu <u>táví álúú</u> no	luta <u>ví</u> ntwáani
C2	/ lítinjí / [ lítíínjì ] ‘pumpkin’	lí <u>tínjì</u> lye <u>é</u> tu ‘our pumpkin’	lí <u>tínjì álíí</u> no	liti <u>njì</u> ntwáani
D1	/ chiyewe / [ chiyèèwè ] ‘chin’	chiye <u>wé</u> cha <u>á</u> ngu ‘my chin’	chi <u>yéwé áchíí</u> no	chiye <u>wé</u> ntwáani
E	/ limbeénde / [ limbééndè ] ‘skin’	limben <u>dé</u> lya <u>á</u> ngu ‘my skin’	li <u>mbéndé álíí</u> no	limbe <u>ndé</u> ntwáani

Table 10: Different types of GT triggered by modifiers in Makonde

Nouns have underlying tone (analyzed as /H/ vs. Ø) which Kraal splits up into a number of tone classes A-E depending on the distribution of H’s. When nouns are modified by modifiers (Kraal’s term is ‘specifier’), different types of GT apply depending on the morpheme and morphosyntactic construction. Possessive pronouns are neutral triggers as a class, and assign a H tone to the final TBU of the noun (column 1). They themselves bear a [LHL] melody in this context.

In contrast, a demonstrative construction (column 2) triggers a H tone to go on the penultimate TBU of the noun and additionally results in a high tone bridge between this grammatical tune and the penultimate TBU of the demonstrative itself. This high tone bridge is not observed with possessive pronouns. Finally, the modifier /ntwáani/ ‘what kind of X?’ is a dominant trigger which deletes underlying tone of the noun, and results in a H on the final TBU of the noun, which Kraal speculates is due to the high tone on the syllabic nasal /ń/ (column 3). We know this is dominant in that it deletes the initial underlying /H/ tone of tone class C2 nouns such as /lítinjí/ [lítíínjì] ‘pumpkin’ (column 3), and is not deleted in the other two contexts (columns 1 and 2). For all three of these modifiers, the resulting output is a single phonological phrase (φ), evidenced by the fact that only the final (phonological) word receives penultimate lengthening in all the cells of the paradigm in the table above.

Kraal is explicit in stating that these GT patterns (and others) hold primarily when the modifier appears directly after the noun. When there are two modifiers (an inner and outer modifier), different results take place. In general, he notes:

*“When two specifiers follow the noun, the first specifier has tonal influence on the preceding noun as described in the previous section (and forms a p-phrase with it), the second specifier generally has no tonal influence on the preceding specifier and shows its inherent tones (and forms a p-phrase on its own; there are two exceptions, see below). There is also no tonal*

*influence from the second specifier when the first specifier is a short demonstrative which cliticizes to the preceding noun.”*

[Makonde - Kraal 2005:262; bolding mine]

We can see this in example (46) below, where the outer modifier is a demonstrative.

- (46)
- |    |                         |   |  |  |
|----|-------------------------|---|--|--|
| a. | / ntandasa a-u-nó /     | → | nta <b>ndásá áúú</b> no                              |  |
|    | porridge this           |   | ‘this porridge’                                      |  |
| b. | / ntadasa únji a-u-nó / | → | ntadaasa <b>únj</b> í auúno                          | ( <sup>x</sup> ntadaasa <b>únjí áúú</b> no ) |
|    | porridge other this     |   | ‘this other porridge’                                |  |
| c. | / ntadasa wavo a-u-nó / | → | ntada <b>sá</b> wa <b>á</b> vo auúno                 | ( <sup>x</sup> ntadasá <b>wávó áúú</b> no )  |
|    | porridge their this     |   | ‘this their porridge’                                |  |
| d. | / ntadasa wavo a-u-nó / | → | ntadasá <b>wávó áúú</b> no                           |  |
|    | porridge their this     |   | ‘this their porridge?’ (special question intonation) |  |
- [Makonde - Kraal 2005:258,261]

When the demonstrative appears immediately after a noun as in a., the GT applies (a penultimate H on the noun plus a high tone bridge). In contrast, when the demonstrative follows an inner modifier such as /ú-nji/ ‘other’ in b. or /wavo/ ‘their’ in c., the grammatical tune does not apply (namely no penultimate H or high tone bridge). Therefore, inner modifier structure is indomitable and cannot be modified by the GT. Kraal does point out, however, that this indomitability is suspended and GT applies as expected under ‘special question intonation’ (example d.).

As Kraal mentions, there are a smaller number of cases where the outer modifier systematically affects the inner modifier. One such case is with /ńtwáani/ ‘what kind of X?’ which is subtractive-dominant, deleting all underlying tones of the noun (with subsequent H tone spread from /ń/), as in (47)a. Examples c. and e. show that when /ńtwáani/ appears after an inner modifier, the inner modifier is not indomitable and its tones are deleted with subsequent H tone docking. Examples b. and d. show what the tones of the inner modifier are when it is not in the context of /ńtwáani/. Note that unlike the modifiers which showed indomitability, /ńtwáani/ forms a single phonological phrase (φ) with the target, evidenced by the single instance of penultimate lengthening.

- (47)
- |    |                               |   |  |  |
|----|-------------------------------|---|--|--|
| a. | / ntandasa ńtwáani /          | → | ntanda <b>sá</b> ńtwáani                     |  |
|    | porridge what.kind            |   | ‘what kind of porridge?’                     |  |
| b. | / ntandasa a-un-ó /           | → | nta <b>ndásá áúú</b> no                      |  |
|    | porridge this                 |   | ‘this porridge’                              |  |
| c. | / [ ntandasa a-u-nó ] ńtwáani | → | nta <b>ndásá</b> au <b>nó</b> ńtwáani        |  |
|    | porridge this what.kind       |   | ‘what kind of this porridge?’                |  |
| d. | / ntandasa wavo /             | → | ntanda <b>sá</b> wa <b>á</b> vo <sup>8</sup> |  |
|    | porridge their                |   | ‘their porridge’                             |  |
| e. | / [ ntandasa wavo ] ńtwáani   | → | ntanda <b>sá</b> wa <b>vó</b> ńtwáani        |  |
|    | porridge their what.kind      |   | ‘what kind of their porridge?’               |  |
- [Makonde - Kraal 2005:283,262]

<sup>8</sup> I created this example based on the grammar, as it was not provided with the discussion.



The examples in (47) are also important as they show that only the tones of the inner modifier are deleted. The noun itself retains the grammatical tune pattern it receives from the inner modifier, namely \ØØHH\ [LLHH] in b.-c. and \ØØØH\ [LLLH] in d.-e. I interpret this as showing a valuation window within the target which consists of a single phonological word, discussed in section 3.3.6 below.

Instances of morphosyntactic indomitability are also found in stress languages, such as in Nez Perce [[nez](#)] (Bjorkman 2010) and Slovenian [[slv](#)] (Marvin 2008). Gouskova & Linzen (2015) highlight the Slovenian case where the dominant trigger /-əts/ NOMINALIZER is pre-stressing.

(48)

a.	/plésal / ‘danced’			
	/plésal + -əts /	→	pləsá ləts	‘dancer’
b.	/plával / ‘swam’			
	/plával + -əts /	→	plavá ləts	‘swimmer’
c.	/tsépljen / ‘vaccinated’			
	/tsépljen + -əts /	→	tse pljenəts	‘somebody vaccinated’
d.	/ránjen / ‘injured’			
	/ránjen + -əts /	→	ra njenəts	‘an injured person’

[Slovenian – Gouskova & Linzen 2015:451, citing Marvin 2008]

With valued targets such as roots with underlying penultimate stress, this results in stress ‘shift’, such as with the non-exceptional targets *l*-participles in (48)a.-b. In contrast, if a stem is formed with an adjectival passive suffix /-n/, the dominant trigger /-əts/ does not shift stress, examples c.-d., which Gouskova & Linzen call ‘conditional dominance’.

Another type of indomitability is **tonological indomitability** where the exceptional targets all share a tonological characteristic. Consider the case of Nzadi [[nzad1234](#)] (Bantu - Crane et al. 2011:47-8).

(49)	Input		Output	
a.	/L/ mùùr ‘person’		\HL\ kó múùr	‘to a person’
b.	/H/ nwí ‘bee’		\HL\ kó nwí	‘to a bee’
c.	/HL/ lôŋ ‘teacher’		\HL\ kó lôŋ	‘to a teacher’
d.	/LHL/ mwáàn ‘child’		\HL\ kó mwáàn	‘to a child’
e.	/LH/ tàá ‘father’	cf.	\LH\ kó tàá	‘to father’ (x \ kó tàà \)

[Nzadi - Crane et al. 2011:47]

Here, the preposition *ko* ‘to’ is a dominant trigger which assigns a HL grammatical tune to the noun (49)a.-d. However, if the noun has underlying tones /LH/, the grammatical tune does not apply and the underlying tones are preserved. The relevant generalization here appears to be that the input string can be one toneme different from the output string (either adding or subtracting a toneme), but it cannot be two tonemes different as would be the case with <sup>x</sup>/LH/ → \HL/. Compare this to the Kalabari case back in (12) above where the grammatical tune /<sup>D</sup>Ⓣ/ from the dominant trigger demonstrative applies regardless of the tonological value of the target noun.

In the Nzadi case, four out of the five input tone melodies allow the grammatical tune, and only one is indomitable. The inverse situation is also attested: every input tone melody is indomitable except for one (or some small minority). Consider the case of Karbi [[mjw](#)] (Naga, Sino-Tibetan – Konnerth 2014). Possessive prefixes including at least *a*- POSSESSIVE and *ne*-1EXCL:POSS trigger /MM/ stems and some /LH/ stems to become \HL/, which is not a general

tonological process in Karbi and therefore morphosyntactically conditioned. This is shown in (50)a.-b.

- (50)
- |    |                      |                  |                  |
|----|----------------------|------------------|------------------|
| a. | /MM/ →               | \ a- <b>HL</b> \ |                  |
|    | /sōpī/ →             | \ a-sópì \       | ‘daughter’       |
| b. | /LH / <sub>1</sub> → | \ a- <b>HL</b> \ |                  |
|    | /bikút/ →            | \ a-bískùt \     | ‘baked snack’    |
| c. | /LH / <sub>2</sub> → | \ a-LH \         | (*\ a-HL \)      |
|    | /lammét/ →           | \ a-lammét \     | ‘literature’     |
| d. | /LL/ →               | \ a-LL \         |                  |
|    | /kòngsin/ →          | \ a-kòngsin \    | ‘kind of shovel’ |
| e. | /LM/ →               | \ a-LM \         |                  |
|    | /kòrpī/ →            | \ a-kòrpī \      | ‘sister-in-law’  |

In contrast, these prefixes do not change tone on another class of /LH/ stems, nor on /LL/ or /LM/ stems, shown in c.-e. (/HL/ are omitted). Discussion of tonal change is restricted to disyllabic stems, and although I did not find an explicit statement saying as such, in other contexts there is no indication of tone change. For example, L tone stems /ne-hìm/ ‘my biscuit’ and /ne-vàm/ ‘my waist’, M tone stems /ne-pī/ ‘my mother’ and /ne-pō/ ‘my father’, and H tone stems /ne-lún/ ‘my song’ and /ne-lám/ ‘my language’ (p. 108).

In discussing these peculiar GT patterns, Konnerth notes the following alluding to the role of stress in determining surface tone patterns:

*“As first pointed out by Grüßner (1978: 21; 39), disyllabic nominal stems may change their tones as well when a prefix is added. Grüßner described this change primarily as a stress shift and the tone change as epiphenomenal, which is certainly an interesting idea worth investigating further.”*

[Konnerth 2014:101]

Given this situation, can this still be classified as grammatical tone? I believe it still can, given the definition of GT: a tonological operation which is not general across the phonological grammar, restricted to a grammatical context. Therefore the Karbi case is GT, albeit one with a very specific grammatical *and* phonological environment.

Comparing the cases in Kalabari with no tonological indomitability, Nzadi with /LH/ indomitability, and Karbi with massive indomitability reveals a cline with extremes at either end.

<b>Kalabari</b> [ DEM N ]		<b>Nzadi</b> [ ko N ] ‘to a X’		<b>Karbi</b> [ a-N ] ‘POSS’d N’	
Target		Target		Target	
Input	Output	Input	Output	Input	Output
/ LL /	\ LH \	/ L /	\ HL \	/ L /	\ L \
/ HL /	\ LH \	/ H /	\ HL \	/ M /	\ M \
/ LH /	\ LH \	/ HL /	\ HL \	/ H /	\ H \
/ HH /	\ LH \	/ LH /	\ LH \	/ ØL /	\ ØL \
/ H!H /	\ LH \	/ LHL /	\ HL \	/ ØM /	\ ØM \
				/ ØH / <sub>1</sub>	\ ØL \
				/ ØH / <sub>2</sub>	\ ØH \
				/ LL /	\ LL \
				/ MM /	\ ØL \

Table 11: Cline of tonological indomitability (cases where GT indomitability is in grey)

When the number of possible underlying melodies on the target is limited, it may be difficult to distinguish between dominant trigger with tonological indomitability vs. a tonological process not involving a tonal overlay vs. highly specialized tone sandhi restricted to particular grammatical and phonological context. Consider Gokana [gkn], in which a /L/ tone logophoric suffix -èè LOG changes only /L/ tone roots to M, e.g. /dò/ ‘fall’ and \dõ-è\ ‘fall-LOG’ (Hyman & Comrie 1981). This tonological operation does not affect roots with other underlying tones, and is restricted to this verbal suffix. I discuss cases of ‘grammatical tone sandhi’ below in section 3.5.3.

Related to tonological indomitability, the final type I introduce is **phonological indomitability** where the exceptional targets all share a phonological characteristic *other* than tone. Consider the Japanese subtractive-dominant suffix *-no* GENITIVE from (15), which has a local valuation window of one mora. This is partially repeated in (51). The subtractive-dominant suffix can only delete an accent if it is on the final mora of the target-host a., but not if it is the penultimate or antepenultimate b. Relevant to this discussion, if a target is monomoraic, *-no* also cannot delete accent. This is a case of phonological indomitability because the unifying characteristic is the size of the target measured in phonological units (moras). The inability for sub-minimal targets to undergo phonological processes is well-established outside of grammatical tone, e.g. Turkish velar deletion which is ‘the norm for polysyllabic roots but the exception for CVC roots’ (Inkelas 2009:394, citations therein), and several other cases in the literature.

(51) Monomoraic phonological indomitability

- |    |                  |   |            |               |
|----|------------------|---|------------|---------------|
| a. | / atama + no /   | → | atama-no   | ‘head-GEN’    |
|    | / kawa + no /    | → | kawa-no    | ‘river-GEN’   |
| b. | / inoti + no /   | → | inoti-no   | ‘life-GEN’    |
|    | / koozyoo + no / | → | koozyoo-no | ‘factory-GEN’ |
| c. | / há + no /      | → | há-no      | ‘tooth-GEN’   |
|    | / kí + no /      | → | kí-no      | ‘tree-GEN’    |

[Japanese – Kawahara 2015:471]

Phonological indomitability is in fact quite rare, which might be surprising given that tonological operations independent of GT frequently interacts with phonological structure, e.g. through consonant depression, attraction to a metrically prominent position (edge effects), among many others. Consider consonant depression in Ik [ikx] (Schrock 2014). Ik is analyzed

as a basic /H/ vs. /L/ tone system, whose tonemes have numerous allotones: /H/ is [H]~[HL]~[HM]~[MH] depending on depressor consonants and other H tonemes in its environment (e.g. /bóʃ/ [bóʃ] with [MH]). Tone depression is rampant throughout Ik grammar, e.g. there is a phonologically general rule in which a string of four low tonemes /L L L L/ becomes \L L **[H]** L\ as in (52)a. (in a derived environment, i.e. not monomorphemic). However, if the third TBU happens to have a depressor consonant in the onset, the H tone is placed on the second TBU, i.e. \L **[H]** L L\ as in b. Schrock refers to processes like these in Ik as ‘high tone repulsion’.

(52) Tone depression

- |    |                              |   |                                  |
|----|------------------------------|---|----------------------------------|
| a. | / L-L LL /                   |   | LL <b>[H]</b> L                  |
|    | / i-a kuwa-k <sup>e</sup> /  | → | ia <b>[kú]</b> wak <sup>e</sup>  |
|    | be-REAL grass-DAT            |   | ‘It’s in the grass’              |
| b. | / L-L LL /                   |   | L <b>[H]</b> LL                  |
|    | / i-a bosik-k <sup>e</sup> / | → | ia <b>[á]</b> bosik <sup>e</sup> |
|    | be-REAL ear-DAT              |   | ‘It’s in the ear’                |

[Ik – Schrock 2014:113]

Consonant depression also affects the distribution of GT. The subordinating conjunction clitic /na<sup>Ⓣ</sup>/ CONJ ‘if/when’ has a floating <sup>Ⓣ</sup> tone which docks to the following morpheme if that morpheme begins with a non-depressor consonant (53)a.-b. If it begins with a depressor consonant, the high tone self-docks to the trigger /na=/ as in c. In this way, targets which begin with depressor consonants are indomitable to this GT.

(53) Phonological indomitability with depressor consonants

- |    |                                 |   |                                 |
|----|---------------------------------|---|---------------------------------|
| a. | / na <sup>Ⓣ</sup> =ŋk-ese... /  | → | na= <b>[ŋ]</b> k-ese...         |
|    | CONJ=eat-SPS                    |   | ‘If <u>   </u> is eaten...’     |
| b. | / na <sup>Ⓣ</sup> =kək-εεε... / | → | na= <b>[kək]</b> -εεε...        |
|    | CONJ=close-SPS                  |   | ‘If <u>   </u> is tied...’      |
| c. | / na <sup>Ⓣ</sup> =gon-ese... / | → | <b>[ná]</b> =gon-ese...         |
|    | CONJ=look-SPS                   |   | ‘If <u>   </u> is looked at...’ |

[Ik – Schrock 2014]

Despite phonological indomitability in this context, depressor consonants can be assigned a <sup>Ⓣ</sup> grammatical tone in other contexts. The pluralive III marker /-ikà-/ is used to ‘pluralize polysyllabic noun roots’ and ‘is the pluralive of choice for borrowed words and therefore the only fully productive pluralive in the Ik language today.’ Despite its productivity, the surface tonal pattern is not predictable, with at least ten input to output mappings with respect to tone patterns, e.g. /LLL/<sub>1</sub> → \LH-HL\ but /LLL/<sub>2</sub> → \HH-LL\. Some of these input-to-output mappings are sensitive to depressor consonants, but in several cases the input has a /D<sup>̂</sup>/ syllable (depressor consonant + low tone), but the output has a \D<sup>̂</sup>\.

- (54) GT insensitive to consonant depressor
- |    |                      |   |                    |              |
|----|----------------------|---|--------------------|--------------|
| a. | / LLL / <sub>3</sub> | → | HL-LL              |              |
|    | / kàbàdā- /          | → | <b>ká</b> bàd-ikà  | ‘rag(s)’     |
|    | / bùbù- /            | → | <b>bú</b> bù-ikà-  | ‘belly(ies)’ |
| b. | / LLH / <sub>2</sub> | → | HL-LL              |              |
|    | / sùgùrá- /          | → | <b>sú</b> gùr-ikà  | ‘wind(s)’    |
|    | / gùbèsí- /          | → | <b>gú</b> bès-ikà- | ‘thigh(s)’   |

[Ik – Schrock 2014:162]

I discussed the relationship of grammatical tone and markedness in section 3.2 above.

To recap, the types of indomitability introduced here were the following:

- (55) Types of indomitability
- Morphemic indomitability
  - Morphosyntactic indomitability
  - Tonological indomitability
  - Phonological indomitability

### 3.3.3 Repairs in GT application

Our discussion of indomitability leads to another topic: what kind of repairs take place in GT application when there is some type of conflict? I repeat the figure detailing the components of grammatical tone below to facilitate the discussion. In this case, the target is valued (has underlying tone), which falls within the valuation window at the left edge. Let us assume that the trigger is recessive, and therefore does not dock to the target because it is valued. In this situation, there are a number of logical repairs for what to do with the ‘leftover’ grammatical tune (the floating <sup>Ⓣ</sup> in this case). I will refer to these as ‘repairs in GT application’. Logically speaking, we could (1) delete the grammatical tune, (2) dock the grammatical tune to the trigger-sponsor, (3) epenthesize a TBU to bear the grammatical tune, or (4) skip over the valuation window and dock outside of it to its right.

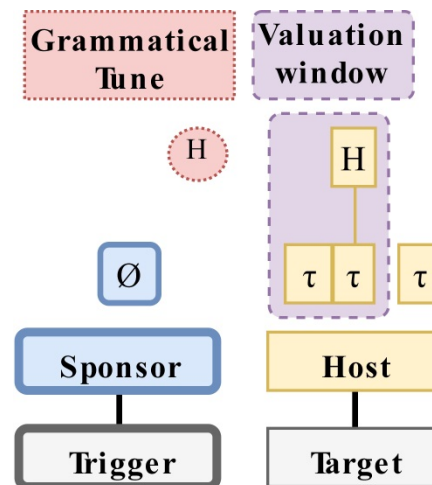

Figure 5: Components of grammatical tone

In this section, I discuss a number of cases where GT application results in a repair, highlighting the following types:

- (56) Repairs in GT application
- Tune deactivation**
  - Self-docking**
  - Non-local docking**
  - Tonal defenestration**

I also discuss repairs in GT application which are theoretically conceivable but which are not empirically attested in my survey: **GT conditioned epenthesis** and **GT conditioned ineffability**.

### 3.3.3.1 Grammatical tune deactivation

**Grammatical tune deactivation** is the most common type of repair in GT application. Here, when a recessive trigger appears with a valued target, or when a trigger appears with an indomitable target, the grammatical tune associated with the trigger simply deletes. This was seen in many cases throughout thus far, one case repeated below from Makonde [kde]. In this language, a demonstrative triggers a H tone to go on the penultimate TBU of the noun and additionally results in a high tone bridge between this grammatical tune and the penultimate TBU of the demonstrative itself (57)a. However, a preceding [NOUN ADJECTIVE] construction is indomitable, in which case the grammatical tune is deactivated and no additional H tone or bridge occurs (b.).

- (57) Grammatical tune deactivation
- / ntadasa a-u-nó / → ntad<sup>á</sup>ásá <sup>á</sup>úúno  
porridge this ‘this porridge’
  - / ntadasa únji a-u-nó / → ntadaasa <sup>ú</sup>únji auúno (x ntadaasa <sup>ú</sup>únjí <sup>á</sup>úúno)  
porridge other this ‘this other porridge’

### 3.3.3.2 Self-docking

**Self-docking** refers to cases where the grammatical tune docks to its sponsor. Cases like this are rarer than deactivation, but are attested in the literature. We saw two examples of this above involving indomitability. In Tommo So, the demonstrative /nó/ assigns a L grammatical tune to the target (58)a., but cannot assign this to a possessive pronoun which is indomitable. In this case, there is variation between the grammatical tune applying to the rest of the target non-locally (b.) and the grammatical tune self-docking to the trigger (the demonstrative in c.). I call this self-docking due to target locality.

- (58) Self-docking due to target locality
- / gámmá + gém + nó / → <sup>g</sup>ámmà <sup>g</sup>èmm nó  
cat black this ‘this black cat’
  - / gámmá + m̩m̩ + nó / → <sup>g</sup>ámmà m̩m̩ nó  
cat 1SG.POSS this ‘this cat of mine’
  - / gámmá + m̩m̩ + nó / → gámmá m̩m̩ <sup>n</sup>no  
cat 1SG.POSS this ‘this cat of mine’

[Tommo So – McPherson & Heath 2016]

In Ik (introduced above), the clitic /na=/ CONJ ‘if/when’ has a floating <sup>®</sup> tune which docks to the target if it begins with a non-depressor consonant (59)a. Targets with depressor consonants are indomitable and result in the tune docking to the trigger itself (b.). I call this self-docking due to target markedness.

- (59) Self-docking due to target markedness
- a. /na<sup>ᵀ</sup>=kək-εεε... / → na=**kək**-εεε...  
 CONJ=close-SPS ‘If \_\_\_ is tied...’
- b. /na<sup>ᵀ</sup>=gon-ese... / → **ná**=gon-ese...  
 CONJ=look-SPS ‘If \_\_\_ is looked at...’

[Ik – Schrock 2014]

Self-docking is rare and often a ‘last-resort’ repair. Several researchers have discussed constraints against self-docking with grammatically conditioned prosody such as with floating tone and accents. Revithiadou (1999:54) adopts a constraint \*DOMAIN which states that “lexical accent should not be associated to the morphological domain that sponsors it”, adopting it from Carleton & Myers’s (1996) work on Chichewa GT (Revithiadou 1999:75-80). Analogous constraints were later proposed for analogous phenomena, e.g. the ‘no tautomorphemic docking’ problem in Wolf (2007:316), the ‘incest taboo problem’ in Trommer (2011:10), and constraints against ‘self-control’ in GT in the Dogon family (McPherson 2014:89).<sup>9</sup>

This is particularly surprising given that in many languages, morphemes sponsor a tone sequence but there is little evidence that the tonemes themselves must be pre-docked to particular TBUs within the sponsoring morpheme, and there is no problem when they do dock to the sponsor. In this way, floating tone and/or grammatical tone is different from ‘normal’ tone. In some languages, floating tones are never docked to their sponsor e.g. San Miguel el Grande Mixtec [*miɡ*] (Tranel 1995).

### 3.3.3.3 Non-local docking

The distance between the trigger-sponsor and the target-host is referred to as **GT locality**, which can be measured either phonologically (adjacency of the strings of phonological units of contrasts and their constituents) or morphosyntactically (hierarchical proximity of the morphemes which expone morphosyntactic terminal nodes). In most cases, the trigger-sponsor and target-host will be local in both senses.

**Non-local docking** refers to cases where a grammatical tune docks to a host which it is not local to. For example, in (58)b. given just above from Tommo So, the grammatical tune docks to the noun even though it is not local due to an intervening indomitable structure. Another example in Tommo So involves intervening degree markers. An adjective is a dominant trigger which assigns a L tone grammatical tune to the modified noun. When the adjective itself is modified by a degree marking /sáy-ni/ ‘very’ as in (60) (which is not the target), the trigger and the target noun are no longer in a local relationship. Regardless, the degree marker is transparent here, and the grammatical tune affects the noun all the same.

- (60) Non-locality with intervening transparent morpheme
- |                         |            |         |                    |
|-------------------------|------------|---------|--------------------|
| <b>án-nà</b>            | sáy-ni     | gábú    | y-àà=bé-m          |
| man-HUM.SG              | very       | tall    | see-PFV=be.PST-1SG |
| TARGET                  | INTERVENER | TRIGGER |                    |
| ‘I saw a very tall man’ |            |         |                    |

[Tommo So - McPherson 2013:239]

A different kind of non-locality can emerge involving non-local TBUs. I exemplify this type from Zimmermann’s (2016) study of San Miguel el Grande Mixtec (data from Mak 1950,

<sup>9</sup> McPherson (2014:89): “in Tommo So, though, as in nearly all Dogon languages, self-control is a last resort option, turned to only when something blocks the overlay from applying to c-commanded words”.

Hollenbach 2003, McKendry 2013). There is a system of ‘tone perturbation’ in which the second word of certain two-word sequences has its tone altered, e.g. /kə̀bà/ ‘day’ + /bíkō/ ‘fiesta’ → \kə̀bà\ bíkō\ ‘fiesta day’, a.o. Zimmermann attributes this to a floating <sup>Ⓣ</sup> tone infix which is inserted after the first tone of the base with a preference to dock to the first TBU, though the specifics of her analysis fall outside of our scope here. The perturbation patterns are in Table 12. What is crucial to note is that the floating <sup>Ⓣ</sup> vacuously affects the /H/ initial inputs (a.), and transparently docks to the first TBU in /L/ initial inputs (c.) (note that contours on a TBU are not permitted by the grammar). The input-output mappings in b. show /M/ initial inputs. In most cases, the <sup>Ⓣ</sup> either vacuously applies or docks to the initial TBU. However, if the input is /ML/ whose segments are /(C)CVCV/ or /CV<sub>1</sub>V<sub>2</sub>/, then the <sup>Ⓣ</sup> docks to the second TBU resulting in a \M<sup>Ⓣ</sup>\ output.

	Input	Output	Context
a	/HH/	→ HH	
	/HM/	→ HM	
	/HL/	→ HL	
b	/MH/	→ MH	
	/MM/	→ <sup>Ⓣ</sup> M	
	/ML/	→ <sup>Ⓣ</sup> L	for (C)CV'(C)V or CV <sub>1</sub> :
		M <sup>Ⓣ</sup>	for (C)CVCV or CV <sub>1</sub> V <sub>2</sub>
c	/LH/	→ <sup>Ⓣ</sup> H	
	/LM/	→ <sup>Ⓣ</sup> M	
	*/LL/		

Table 12: Non-local docking of <sup>Ⓣ</sup> San Miguel el Grande Mixtec GT

What is important to take away here is that under specific phonological conditions, a grammatical tone docks non-locally, rather than deleting (tone deactivation) or falling on another host such as the trigger (self-docking).

### 3.3.3.4 Tonal defenestration

A final repair which is found in GT systems is what I call **tonal defenestration**. This requires some explanation. Recall that targets can have valuation windows within which it is assessed whether a TBU is valued or not, and subsequently determines where and when the grammatical tone will dock. A valuation window is by default coextensive with the target, while a local valuation window includes only some local portion. Tonal defenestration refers to the underlying tone of the target within the valuation window being undocked from any TBUs within the window, but crucially not deleted. They either dock to a TBU outside of this window in the output (hence ‘defenestration’), or remain floating in the output (and may or may not later dock in subsequent cycles, or delete).

[Def 7] **Tonal defenestration**: undocking an underlying toneme from a TBU within the valuation window of the target, without automatically deleting it



	trigger	+	target	/ → \	m <sub>1</sub>	m <sub>2</sub>	Surface	Defenestration type
a.	M <sup>L</sup>   τ		H   τ τ	/ → \	M <sup>L</sup>   τ	H   τ τ	[M L H]	<b>Docking</b> outside local valuation window
b.	M <sup>L</sup>   τ		H   τ τ	/ → \	M <sup>L</sup>   τ	L <sup>H</sup>   τ τ	[M L L]	<b>Floating</b> outside local valuation window
c.	M <sup>L</sup>   τ		H   τ τ	/ → \	M <sup>L</sup>   τ	L <sup>H</sup>   τ τ	[M L L]	<b>Floating</b> outside valuation window

Table 13: Hypothetical types of tonal defenestration with different valuation windows

With non-local docking, the grammatical tune docks to a non-local host. With tonal defenestration, the underlying tones of the host dock non-locally but the grammatical tune appears local.

Let's examine a case of docking outside of the local valuation window. I introduced the Bantu language Jita in several places above. Jita has a general tonological operation 'Meeussen's Rule' whereby /HH/ → \HØ\ . An example is in (61)a below with high tone object marker before a high tone verb root. Note that all surface forms in Jita are subject to H tone rightward shift, given in [ ]. Contrast this to the examples in b. exhibiting tonal defenestration. Here, there are two object markers each which sponsors a H tone. In this construction, the H tone of the second object marker defenestrates moving out of the local valuation window, and docks to the final TBU of the stem.

(61)

- a. Meeussen's rule /HH/ → \HØ\  
 / oku-**mú**-**βóna** / → \ oku-**mú**-βóna \ [okumuβóna]  
 INF-OM-see 'to see him/her'  
 / oku-**βá**-**síndika** / → \ oku-**βá**-síndika \ [okuβásiíndika]  
 INF-OM-push 'to push you pl./them'
- b. Tonal defenestration of H tone on second object marker  
 / oku-**gú**-**mú**-sonera / → \ oku-**gú**-mu-sone**rá** \ [okugumúsonerâ]  
 INF-OM.3-OM-sew 'to sew it (cl.3) for him/her'  
 / βa-a-**mú**-**ci**-lomeeye / → \ βa-a-**mú**-ci-lomee**yé** \ [βaamucílomeeyê]  
 they-T/A-OM-OM-talk\PFV 'they have talked to him/her for us'

[Jita – Downing 2014:104,110]

Such cases of tonal defenestration are rare, and are often subject to other interpretations.

It is interesting that such cases should be rare given that (rightward) tonal shifts which are not grammatically conditioned are very common, given the articulatory predisposition for pitch to be realized late in the pitch-target. Two consequences of such 'pitch delay' are shown below illustrating general tonological operations not morphosyntactically conditioned, from Hyman (2007:6). In (62) from Yoruba [yor] (Benue-Congo), the /H/ and /L/ tones are realized on the sponsor and the following TBU. Taken one step further is Kuki-Thaadow [tcz] (Kuki-Chin) in (63), where the toneme completely delinks and docks to the following TBU.

(62) / máyò mí rà wé /  
 má yò mí rà wé → [máyòmǐ râ wě]  
 | ..... | ..... | ..... | ..... |  
 H L H L H  
 ‘Mayomi bought books’

[Yoruba – Hyman 2007:6, citing Laniran & Clements 2003:207]

(63) / kà zóón lién thúm /  
 kà zóón lién thúm → [kà zòòn lién thùm]  
 | ..... | ..... | ..... | ..... |  
 L H L H  
 ‘my three big monkeys’

[Kuki-Thaadow - Hyman 2007:6]

### 3.3.3.5 Unattested repair 1 – GT conditioned epenthesis

Another repair not found is **GT conditioned epenthesis**. Consider the tonological indomitability case from Nzadi, in which the grammatical tune HL cannot alter an input /LH/, repeated below.

(64)	Input		Output	
a.	/L/ mùùr ‘person’		\HL\ kó <b>mùùr</b>	‘to a person’
b.	/H/ nwí ‘bee’		\HL\ kó <b>nwí</b>	‘to a bee’
c.	/HL/ lôŋ ‘teacher’		\HL\ kó <b>lôŋ</b>	‘to a teacher’
d.	/LHL/ mwáàn ‘child’		\HL\ kó <b>mwáàn</b>	‘to a child’
e.	/LH/ tàá ‘father’	cf.	\LH\ kó <b>tàá</b>	‘to father’ (x \ kó <b>táà</b> \)

[Nzadi - Crane et al. 2011:47]

Under GT epenthesis, an epenthetic TBU would be inserted to realize the HL pattern *only* in the context when it cannot dock to a host present in the input. For instance, examples a.-d. above would be identical, but example e. would be \kó **tàá** with an epenthetic \ə\ inserted to host the grammatical tune.<sup>10</sup> The lack of GT epenthesis is particularly striking in cases of independent prosodic exponents in which the only cue for the grammatical category is the grammatical tune which then remains unexpressed, e.g. for the first two Giphende floating <sup>Ⓣ</sup>s in Table 3 and Table 5 above. Again, however, the non-existence of such cases depends on one’s analysis, and many cases may exist which have not been described as epenthesis.

Note that the only potential case I have seen for epenthesis to realize a floating tone generally is Arapaho [arp] (Cowell & Moss 2008):

(65) Epenthesis of TBU to realize floating tone  
 / néihoow- / + / <sup>Ⓣ</sup>-betéee / → \ néihoow-**ú**-betéee \  
 1S NON-AFFIRM.NEG ‘to dance’ [translation not given]  
 [Arapaho – Cowell & Moss 2008:482]

Counter-analyses exist of this data (Gleim 2018, citing Blumenfeld 2006:41), and in the great majority of cases floating tones are not realized with epenthesis.

<sup>10</sup> Larry Hyman (p.c.) points out that the schwa would in fact be realized as H [ə] on the surface, since HL becomes H before L by tone absorption in Nzadi. This example is merely hypothetical and I therefore simplify matters above.

### 3.3.3.6 Unattested repair 2 - GT conditioned ineffability

The last unattested pattern I will discuss is **GT conditioned ineffability**. In this case, when a recessive trigger occurs with a valued target or when a trigger appears with an indomitable target generally, no actual repair takes place and the grammatical meaning is simply not expressible using that input. This would result in a ‘gap’ in the paradigm of that trigger, and would result in a periphrastic construction. Linguistic ineffability is quite challenging for Optimality Theoretical approaches in particular, which have as a central tenet that any input can be mapped to an appropriate output given a set of ranked or weighted constraints.

Although GT ineffability is unattested in my survey, it is attested in stress systems. Kager (2000) details a case of stress-based ineffability in Dutch. Certain suffixes in Dutch such as *-ig* and *-elijk* require that the preceding stem have final stress which Kager formalized as a SUFFIX-TO-PEAK constraint (‘the left edge of affix *-ig* coincides with the right edge of the stress peak’). When these suffixes combine with a stem with final stress, this constraint is obeyed, as in (66)a. However, these suffixes are not able to shift the stress of stems which do *not* have final stress and due to the suffix-to-peak constraint cannot combine with them if they retain their input stress. The result is ineffability where the intended meaning cannot be expressed as such, shown in the ungrammatical forms starred in b. with penultimate stressed inputs *ménthol* and *cháos*.

(66) Stress-based ineffability in Dutch

a.	huméur	‘temper’	huméur-ig	‘moody’	
	veníjn	‘venom’	veníjn-ig	‘venomous’	
	schandáal	‘scandal’	schandáal-ig	‘scandalous’	
	moerás	‘marsh’	moerás-ig	‘marshy’	
b.	ménthol	‘menthol’	*ménthol-ig	*menthól-ig	(intended: ‘menthol-like’)
	cháos	‘chaos’	*cháos-ig	*chaós-ig	(intended: ‘chaotic’)

[Dutch – Kager 2000:142-143]

An analogous situation for grammatical tone would be a hypothetical trigger /ámà<sup>Ⓛ</sup>/ which only appears with L tone nouns, otherwise ineffability resulting (e.g. with H tone nouns). I have found no case of this.

### 3.3.4 Catalyzed dominance – Cases of exceptional triggers

As a counterpoint to the discussion of GT indomitability overlooking exceptional targets, I will now discuss what I call **catalyzed dominance** overlooking exceptional *triggers*. I define it as the following:

[Def 8] **Catalyzed dominance**: the idiosyncratic behavior of a certain morpheme or construction (or natural class of morphemes or construction) to cause a different morpheme or construction in its environment to act as a trigger of a grammatical tone operation

The term **catalyst** is taken from Heath (2016) discussing Donno So [dds] (Dogon) in which a definitive clitic is a dominant trigger only in the context of a numeral (“the numeral catalyzes the definite clitic, activating an otherwise latent control power by the definite” – p. 240). This so-called GT ‘activation’ from a GT catalyst is illustrated below. In row a., a noun appears with the definitive clitic =gò (~=ḁ) and triggers no change in the noun which surfaces with its underlying tones. In b., these nouns concatenate with a numeral which also triggers no tonal change. However in c. with the sequence [N NUM=DEF], the numeral ‘catalyzes’ the definite clitic which

now triggers a LH grammatical tune on the target, not seen in a. with nouns alone. Heath refers to these types of triggers as ‘latent controllers’ in Dogon.

Construction	/ idú / /LH/ ‘dog’	/ ódù / /HL/ ‘road’		
a. N=gò DEF	idú=gò [~idóó]	‘the dog’	ódù=gò	‘the road’
b. N lěy ‘two’	idú lěy	‘two dogs’	ódù lěy	‘two roads’
N tà:ndú ‘three’	idú tà:ndú	‘three dogs’	ódù tà:ndú	‘three roads’
N kúlè: ‘six’	idú kúlè:	‘six dogs’	ódù kúlè:	‘six roads’
c. [N lěy]= <sup>ⓁⓂ</sup> gò	<b>idù lěy</b> =gò	‘the two dogs’	<b>òdù lěy</b> =gò	‘the two roads’
[N tà:ndú]= <sup>ⓁⓂ</sup> gò	<b>idù tà:ndó</b> =gò	‘the three dogs’	<b>òdù tà:ndú</b> =gò	‘the three roads’
[N kúlè:]= <sup>ⓁⓂ</sup> gò	<b>idù kúlé:</b> =gò	‘the six dogs’	<b>òdù kúlé:</b> =gò	‘the six roads’

Table 14: Catalyzed dominance from inside the target [*Donno So* - Heath 2016]

In this case, the catalyst is within the target domain of the trigger. In Dogon, there is also the situation when the catalyst is outside of the target domain and not within the scope of the grammatical tune. Consider the case of Yorno So [*dts*] (McPherson 2014). On their own, numerals do not act as dominant triggers as shown in (67)a. where the underlying tones of the noun appear in the output. However, when these numerals occur in the context of a possessor which follows the numeral, numerals become dominant triggers and a L pattern to the noun, their target. McPherson (2014:134) refers to these as ‘contingent controllers’. In the example below, the catalyst /wò-mò/ ‘his’ appears outside of the target domain of the catalyzed trigger /kúlòy/ ‘six’.

(67) Catalyzed dominance *not* from inside the target

- a. / gèr<sup>n</sup>é kúlòy / → gèr<sup>n</sup>é kúlòy  
house six ‘six houses’
- b. / gèr<sup>n</sup>é<sup>Ⓛ</sup> kúlòy wò-mò / → **gèr<sup>n</sup>é** kúlòy wò-mò  
house six 3SG-POSS ‘his six houses’

[*Yorno So* - McPherson 2014:50]

In general, catalyzed dominance of any kind is rare in the grammatical tone literature (or at the very least are not reported or described in such a way as to easily identify them).

### 3.3.5 Grammatical allotunes

In section 3.3.2 GT indomitability above, I discussed the existence of exceptional targets which are not subject to the trigger’s grammatical tune, and in section 3.3.4 on catalyzed dominance I discussed the existence of exceptional triggers. In both of these latter cases, the context dictates whether a grammatical tune appears on the target-host. Related to these cases are **grammatical allotunes**, in which the trigger has multiple grammatical tunes in complementary distribution. In cases where it is clear that the GT is morphological exponence, these are essentially allomorphs.

- (68)
- |                         | Context 1:<br><u>Elsewhere</u> | = | Context 2:<br><u>Specific</u> |
|-------------------------|--------------------------------|---|-------------------------------|
| a. Unexceptional GT     | T                              | = | T                             |
| b. Indomitability       | T                              | ≠ | ∅                             |
| c. Catalyzed dominance  | ∅                              | ≠ | T                             |
| d. Grammatical allotune | T <sub>1</sub>                 | ≠ | T <sub>2</sub>                |

Like (segmental) allomorphy, grammatical allotunes are common in GT patterns. I discuss only those patterns in which the allotune is not derivable through a general tonological process and therefore must be specific to the context of the particular GT pattern.

One clear set of allotunes is found in Tommo So. Pre-nominal possessive pronouns are dominant, and assign a H tone to two mora targets but a HL tone to three or more mora targets.

(69) Grammatical allotunes

a.	/ náá / ‘mother’	/ wó <sup>Ⓜ</sup> náá /	→	wó <b>náá</b>	‘his mother’
	/ bàbé / ‘uncle’	/ mí <sup>Ⓜ</sup> bàbé /	→	mí <b>bábé</b>	‘my uncle’
b.	/ ánígé / ‘friend’	/ wó <sup>ⓂⓁ</sup> ánígé /	→	wó <b>ánigè</b>	‘his friend’
	/ tírê-àn-ná /	/ mí <sup>ⓂⓁ</sup> tírê-àn-ná /	→	mí <b>tírê-àn-nà</b>	‘my grandfather’
	‘grandfather’				

[Tommo So - McPherson & Heath 2016]

The moraic count of the target also conditions allotunes in Jita ‘melodic tone’ (patterns common throughout Bantu – Odden & Bickmore 2014). Downing (2014) shows that PRESENT CONTINUOUS verb inflection is expressed with auxiliary prosodic exponence displaying a number of surface patterns of considerable complexity (Downing calls it a ‘chaotic pattern’, citing Goldsmith 1987). Present continuous forms are given below with the prefix unit /kaa-/ ‘s/he Xs ~ is Xing’ combined with 1-4 mora verb stems. Underlying toneless (L-toned) stems are in row a., while those with an initial H are in row c. (the underlying sponsor of the H tone is underlined). As discussed throughout, note that Jita exhibits rightward tone shift in surface forms, given in [ ].

With toneless roots in row a., 1 $\mu$  and 2 $\mu$  stems receive a final H tone, 3 $\mu$  stems receive a penultimate H, and 4 $\mu$  stems receive an initial H as well as a final H. The output forms with grammatical allotunes are schematized in row b. In contrast, H-toned stems are not assigned any grammatical tune in this context and retain their underlying tones in the output, and the present continuous construction is therefore classified as a recessive trigger. In addition to illustrating several allotunes which cannot straightforwardly be reduced to a single underlying representation, these data show that grammatical allotunes do not affect the dominance value of the trigger, which remains recessive in all contexts. This provides further evidence that dominance is a morphological feature of trigger and is not a feature of the tune.

	1 $\mu$	2 $\mu$	3 $\mu$	3 $\mu$	4 $\mu$ (+)	4 $\mu$ (+)
a.	/ gwa / /Ø/	/ liya / ‘pay’	/ luuβa / ‘follow’	/ sakira / ‘help’	/ gosoora / ‘unweave’	/ βirimira / ‘run toward’
	\ kaa- <b>gwá</b> \	\ kaa- <b>liyá</b> \	\ kaa- <b>luúβa</b> \	\ kaa- <b>sakíra</b> \	\ kaa- <b>gósoorá</b> \	\ kaa- <b>βírimirá</b> \
	[kaagwá]	[kaaliyá]	[kaalúúβa]	[kaasakíra]	[kaagosóorá]	[kaaβírimirá]
	‘s/he falls’	‘s/he pays’	‘s/he follows’	‘s/he helps’	‘s/he unweaves’	‘s/he runs toward’
b.	\ - <sup>Ⓜ</sup> \	\ - <sup>Ⓜ</sup> \	\ - <sup>Ⓜ</sup> \	\ - <sup>Ⓜ</sup> \	\ - <sup>Ⓜ</sup> \	\ - <sup>Ⓜ</sup> \
c.	/ <u>lyá</u> /	/ <u>βóna</u> /		/ <u>βónera</u> /		/ <u>tégeresya</u> /
/H/	‘eat’	‘see’		‘get for’		‘listen’
	\ kaa- <b>lyá</b> \	\ kaa- <b>βóna</b> \		\ kaa- <b>βónera</b> \		\ kaa- <b>tégeresya</b> \
	[kaalyá]	[kaaβóna]		[kaaβónera]		[kaategéresya]
	‘he is eating’	‘s/he sees’		‘s/he gets for’		‘s/he listens’

Table 15: Grammatical allotunes with recessive trigger in Jita

Grammatical allotunes can also be conditioned by the underlying tonal value of the target. Gaahmg [tbi] (Nilo-Saharan – Stirtz 2011) has three underlying tonemes /H, M, L/ which are (largely) free to combine to form complex melodies in multi-TBU words. Genitive case is

marked exclusively through tone changes (independent prosodic exponence), common in this part of East Africa. Stirtz illustrates that for nearly all tone melodies, their underlying tones are replaced by a ML grammatical tune in the genitive; compare the singular and singular (genitive) columns in Table 16 below. The only exceptions are underlying /M/ and /MH/ tones which take a HL allotune in this context, rows b. and f. The columns plural (genitive) and definite plural (genitive) show that these grammatical allotunes are stable across other grammatical contexts, illustrating the interaction of allotunes with the ‘outer dominance principle’ (defined in [Def 5]).

	Input	Output	SG	SG (GEN)	PL (GEN)	DEF PL (GEN)	
a.	/H/	\ML\	tɔ́ɔ	tɔ̀ɔ	tɔ̀-gg	tɔ̀-gg = ɔ̀	‘cow’
b.	/M/	\HL\	mīi	mī̀i	mī̀i-gg	mī̀i-gg = ɔ̀	‘goat’
c.	/L/	\ML\	ɖii	ɖìi	ɖìi-gg	ɖìi-gg = ɔ̀	‘rat’
d.	/HM/	\ML\	súlɔ̃	sulɔ̀	sulɔ̀-əgg	sulɔ̀-əgg = ɔ̀	‘clan member’
e.	/HL/	\ML\	wírì	wirì	wirì-ìgg	wirì-ìgg = ɔ̀	‘bird’
f.	/MH/	\HL\	tɛ̀ndás	tɛ̀ndàs	tɛ̀ndàs-əgg	tɛ̀ndàs-əgg = à	bird species
g.	/ML/	\ML\	nū̀ui	nū̀ui	nū̀uy-g	nū̀uy-g = ɔ̀	‘leopard’
h.	/LH/	\ML\	əggáár	əggàar	əggàar-g	əggàar-g = à	‘hunter’
i.	/LM/	\ML\	mɔ̀rāā	mɔ̀rāà	mɔ̀rāà-gg	mɔ̀rāà-gg = à	‘governor’
j.	/MHM/	\ML\	kū̀dū̀urīi	kū̀dū̀urìi	kū̀dū̀urìi-gg	kū̀dū̀urìi-gg = ɔ̀	bird species

Table 16: Grammatical allotunes conditioned by underlying tone in Gaahmg (Stirtz 2011:125)

I have not surveyed grammatical allotunes extensively, and will not comment about other phonological factors conditioned allotunes, or whether morphological factors can condition allotunes (e.g. an affix triggers a HL tune on simplex, monomorphemic targets but H on complex, multimorphemic targets).<sup>11</sup>

When there are several surface tone patterns expressing a grammatical category, it is not straightforward whether to analyze it as extensive grammatical allotunes or as idiosyncratic allomorphy of entire stems. Consider the case of Tugen [tuy] (Nilotic – Jerono 2013) in the table below. Like in the fellow East African language Gaahmg, case in Tugen is expressed through tonal changes. However unlike Gaahmg, there is no consistent output pattern and further little predictability based on the input tones. There are at least 15 input-output mappings and appear to be both lexically and phonologically arbitrary.

<sup>11</sup> An example of a morphosyntactic property of the target conditioning allotuny comes from the Dogon language Toro Tegu [dtt]. McPherson points out that “core NP possessors assign {L} to the possessed noun while complex NP possessors assign {HL}” (McPherson 2014:169).

	Absolutive (=Elsewhere)	Tone	Nominative (=Subject)	Tone	Gloss
a.	kibùkàndiì chèèp-ò	L L	kibùkándíí chéép-ò	LH HL	guitar daughter of
b.	kwááriík móítá káályááng'ík	H H H	kwááriik mòità kàályááng'ík	HL L LH	tendon calf flies
c.	mùrsíik chèèmòòsíí	LH LH	mùrsiik chéémóòsíí	L H	sour milk ogre
d.	káámèè cháálwòók séèsèè	HL HL HL	kààmèè cháálwóók séèséé	L H HLH	mother wrongdoing dog
e.	láákwéé òinóòsyék	HLH HLH	láákwéé òinòòsyèk	H HL	child rivers
f.	ùsíí	LHL	úsíí	H	thread
g.	bèelyóòndé kíkóòmbéé	LHLH LHLH	béelyóóndé kíkóòmbéé	H HLH	elephant cup

Table 17: Extreme grammatical allotony in Tugen (Jerono 2013)

In some East African languages where tone expresses case, it may be better analyzed as ‘construct state’ allomorphs, described in section 3.5.1 below. This position can be supported if the ‘grammatical tune’ scopes only over the noun and does not change if the domain becomes bigger via additional modification, as is the case with Northern Mao [myf] (Ahland 2012; refer to McPherson 2014:286 for illustration of the uniformity of constructs tunes in different grammatical contexts, as based on p.c. with Ahland). This would be unlike the Gaahmg case in Table 16 above where the HL allotune applies regardless of target size.

### 3.3.6 Valuation windows with complex targets

In (1)f, I defined a valuation window as the portion of the target-host which is evaluated with respect to whether its TBUs are valued or unvalued. This can be coextensive with the size of the entire target-host, or local and not coextensive. In the examples seen thus far, local valuation windows were demarcated phonologically, e.g. the last mora in Japanese (15). With complex targets, one may also define the valuation window morpho-phonologically.

Recall the facts from Makonde from Table 10 above. The modifier /ńtwáani/ ‘what kind of X?’ is a dominant trigger which deletes underlying tone of the noun, and results in a H on the final TBU of the noun, shown below.

Tone Class	≈/ Underlying /	[ Citation ]	Translation	/ + ńtwáani / ‘what kind of X?’
A	/ chitúví /	[ chitúúví ]	‘bundle’	\ chituví ńtwáani \
B	/ litáwa /	[ litááwà ]	‘clan’	\ litawá ńtwáani \
C1	/ lutaví /	[ lùtáávi ]	‘branch’	\ lutaví ńtwáani \
C2	/ lítinjí/	[ lítíinjì ]	‘pumpkin’	\ litinjí ńtwáani \
D1	/ chiyewe /	[ chiyèèwè ]	‘chin’	\ chiyewé ńtwáani \
E	/ limbeénde /	[ limbéèndè ]	‘skin’	\ limbendé ńtwáani \

Table 18: Dominant GT in Makonde (Kraal 2005)

Other modifiers trigger different GT patterns, shown in (70)a.-b. (repeated from above). When /ńtwáani/ is the outer modifier following these inner modifiers, it still triggers a GT pattern as expected from the outer dominance principle in [Def 5]. However, this example reveals that only

the tones of the inner modifier are deleted, e.g. the tone is \áúno\ in a. and \waávo\ in b., but uniformly \aunó\ and \wavó\ in c. and d. Importantly, the pattern of the noun itself retains the grammatical tune pattern it receives from the inner modifier and is not subject to the dominant outer trigger. Namely it retains \ØØHH\ [LLHH] in c. (compare to a.), and \ØØØH\ [LLLH] in d. (compare to b.).

(70)			
a.	/ ntandasa a-un-ó / porridge this	→	nta $\overline{\text{ndásá}} \overline{\text{áúú}}$ no ‘this porridge’
b.	/ ntandasa wavo / porridge their	→	ntanda $\overline{\text{sá}}$ wa $\overline{\text{á}}$ vo ‘their porridge’
c.	/ [ ntandasa a-u-nó ] ítwáani porridge this what.kind	→	nta $\overline{\text{ndásá}}$ au $\overline{\text{nó}}$ ítwáani ‘what kind of this porridge?’
d.	/ [ ntandasa wavo ] ítwáani porridge their what.kind	→	ntanda $\overline{\text{sá}}$ wa $\overline{\text{vó}}$ ítwáani ‘what kind of their porridge?’
			[Makonde - Kraal 2005:283,262]

Note that /ítwáani/ forms a single phonological phrase ( $\phi$ ) with both words within the target domain, evidenced by the single instance of penultimate lengthening on the final word (cf. (46) above with multiple instances). We may therefore say that the subconstituents within the phonological phrase are phonological words ( $\omega$ ). In c. and d. then, the phonological phrase consists of three phonological words, and the local valuation window of the dominant trigger /ítwáani/ is only the immediately preceding phonological word. This can be understood as a type of **bracketing paradox**. This is schematized below:

(71)	Local valuation window of one phonological word	
a.	/ ( $\omega$ ntandásá) ( $\omega$ áúúno) ítwáani \	→ \ ( $\phi$ ( $\omega$ ntandásá) ( $\omega$ <b>aunó</b> ) ( $\omega$ ítwáani) ) \
b.	/ ( $\omega$ ntandásá) ( $\omega$ waávo) ítwáani \	→ \ ( $\phi$ ( $\omega$ ntandásá) ( $\omega$ <b>wavó</b> ) ( $\omega$ ítwáani) ) \
		[Makonde – Kraal 2005:262]

I put forward the following tentative hypothesis regarding local valuation windows:

[Def 9] **Phonological localization of valuation windows:** valuation windows can be localized to phonological constituents at any level on the prosodic hierarchy

It remains to be seen whether windows can be localized to particular morphological constituents, and in the absence of this in ambiguous cases I will interpret it as a phonological constituent.

### 3.4 Trigger/target asymmetries

This section discusses **trigger/target asymmetries** in grammatical tone application. The most pressing question I will address is what can be a trigger and what can be its target within a multi-morphemic configuration?

Within the wider theoretical literature on prosody (stress, accent, pitch-accent, tone, etc.), there have been several attempts to equate dominance with particular morphosyntactic configurations or syntactico-semantic properties of the trigger. Early attempts include Kiparsky’s (1984) work on Sanskrit accent, where he claims with respect to ordering relations that “dominant suffixes may precede but never follow recessive suffixes” (p. 206), rebutted in some detail in Inkelas (1998). For accentual dominance, Gouskova & Linzen (2015:453) discuss several attempts in the literature, and themselves show a correlation between dominance behavior and ‘adjunct’ vs. ‘head’ affixes (p. 457-458). For grammatical tone in Dogon languages



such as Ben Tey [dbt], Heath & McPherson (2013:276) claim that what unites the dominant triggers (=‘tonosyntactic controllers’) is what they call the semantic notion of ‘reference restriction’.

Such asymmetries have not been extensively surveyed for grammatical tone patterns cross-linguistically, although smaller attempts have been made. In Harry & Hyman’s (2014) discussion of Kalabari GT, they note the following generalizations of systems “where phrase-level tones are exclusively determined by a specific constituent within the respective phonological phrase” (p. 680). I have updated the wording of these generalizations to match the terminology used here.

- (72) Generalizations of phrase-level GT (Harry & Hyman 2014:680-681)
- a. Modifier/specifier targets the head of an NP/VP
  - b. Object targets the head of a VP
  - c. The tonal effects are more commonly perseverative (i.e. trigger before target)
  - d. Perseverative patterns can assign the grammatical tune or involve reduction/L-tone assignment
  - e. Anticipatory patterns only involve reduction/L-tone assignment
  - f. Construction tonology can involve tone melodies while lexical cases only involve a single toneme (H, or L)
  - g. Only tone shows these collection of properties

This section will critically examine my typological survey with these questions in mind. I will approach this from two angles: what morphosyntactic asymmetries emerge between the trigger and target (addressing generalizations in a. and b. above), and what phonological asymmetries emerge between the trigger and target (addressing generalizations c., d., and e.).

Unlike Harry & Hyman’s survey, my survey explicitly does not make a distinction between word-level cases where the trigger and target are in a ‘single word’ (e.g. [ROOT+AFFIX]) or phrase-level cases where they do not (e.g. [MODIFIER + ‘HEAD’]). Further, I also will discuss GT relevant to particular triggers, as several important asymmetries will emerge.

### 3.4.1 Morphosyntactic asymmetries

The major focus of this section will be establishing the **dominant GT asymmetry**, illustrated in the table below.

GT type		Non-dominant (e.g. simple docking)	Dominant (e.g. replacive)
Trigger → Target			
Grammatical/ Dependent	→ Lexical head	✓ Yes	✓ Yes
Lexical head	→ Grammatical/ Dependent	✓ Yes	* No

Table 19: Comparing dominant vs. non-dominant GT

At the top are non-dominant vs. dominant GT, as established in the previous sections. At the left is the application of a grammatical tune from a trigger onto a target which shows two types: a morpheme trigger with a lexical head target, or a lexical head trigger with a morpheme target. A grammatical trigger may be non-dominant (e.g. simple docking) or may be dominant (whether replacive or subtractive). In contrast, a lexical head trigger may only be non-dominant. Any tonal operation which it triggers does not show dominant GT of any kind. This is what is meant by the dominant GT ‘asymmetry’.

### 3.4.1.1 Dominant triggers

We can frame the dominant GT asymmetry with typological terms **head** and **dependent**, as established by Nichols (1986). Nichols defines the head as determining the category of the phrase, and provides examples of head-dependent pairings as in (73).

*“Briefly, the head is the word which governs, or is subcategorized for—or otherwise determines the possibility of occurrence of—the other word. It determines the category of its phrase.”*

[Nichols 1986:57]

(73)	HEAD	DEPENDENT
a. Phrase	possessed noun noun adposition	possessor modifying adjective object of an adposition
b. Clause	predicate auxiliary verb	arguments and adjuncts lexical (‘main’) verb
c. Sentence	main-clause predicate	relative or subordinate clause

At the phrase level, head-dependent pairings include noun-modifier constructions of all types (not just adjectives). At the clause/sentence level, this includes a main verb plus arguments (subjects and objects), as well as main-clause predicate (the head) vs. subordinate clause (the dependent). This head-dependent distinction is especially exploited in Dependency Grammar, as in Jurafsky & Martin (2017). They attribute the distinction of a ‘head’ at least as far back as Bloomfield (1914), and note its central role in Head-Driven Phrase Structure Grammar (Pollard & Sag 1994), as well as computational linguistics (p. 18).

In chapters 4-6, I couch my study of GT within generative linguistics and the Minimalist Program (Chomsky 1995) which is substantially different from these approaches. In contrast to Dependency Grammar, the theoretical distinction between ‘head’ and ‘dependent’ plays little to no role in current generative linguistics where all phrases contain a ‘head’ (i.e. a terminal element  $X^0$ ). For this reason, in this typological part of the study I will refer to the head-dependent dichotomy as ‘lexical head’ vs. ‘dependent’, which I find to be more theory neutral. Thus as Jurafsky & Martin establish, a noun is the lexical head of a noun phrase and a verb is the lexical head of a verb phrase; other elements within these phrases are dependent, whether they be independent words or bound affixes.

With this as our background, let us therefore define the **dominant GT asymmetry**:

[Def 10] **Dominant GT asymmetry**: within a multi-morphemic constituent, the dominant trigger is a dependent, and the target is a lexical head or a dependent structurally closer to the lexical head

This definition has two components: (i) the asymmetry between what the identity of triggers and targets within dominant GT, and (ii) that dependents can affect other dependents if they are ‘closer’ to the lexical head in some relevant sense. Taken together, we can exemplify the dominant GT asymmetry as in the table below, referring to examples present in this chapter. Note that the symbol  $\blacktriangleright$  means ‘dominant over’ (and thus  $\neg\blacktriangleright$  means ‘not dominant over’).

	<b>Trigger</b>	<b>Target</b>	<b>Example</b>	<b>cf.</b>	<b>Trigger</b>	<b>Target</b>
a.	Affix Affix <sub>OUT</sub>	▶ Root ▶ [Affix <sub>IN</sub> -Root] <sub>STEM</sub>	<i>Japanese</i> (14) <i>Hausa</i> (37)	d.	Root Affix <sub>IN</sub>	↯▶ Affix ↯▶ Affix <sub>OUT</sub>
b.	Modifier Modifier <sub>OUT</sub>	▶ Noun ▶ [Modifier <sub>IN</sub> N]	<i>Kalabari</i> (12) <i>Izon</i> (34) <i>Jamsay</i> (35)	e.	Noun Modifier <sub>IN</sub>	↯▶ Modifier ↯▶ Modifier <sub>OUT</sub>
c.	Object	▶ Verb	<i>Izon</i> (82) (below)	f.	Verb	↯▶ Object

Table 20: Exemplification of the dominant GT asymmetry

This asymmetry shows three main generalizations, in rows a.-c. and d.-f. First in a., affixes can be triggers of dominant GT with a root (the lexical head) as its target shown in Japanese (14). Also, outer affixes which are further away from the root can be triggers of dominant GT to both inner affixes (inner dependents) and the root (the lexical head), shown in Hausa (37). This shows that elements other than the lexical head can be targeted, requiring a more articulated model. This will be the focus of chapter 6 where I will formally define and derive notions of ‘inner’ and ‘outer’ familiar to morphological theory.

Further, row b. shows that modifiers follow the same pattern: they are triggers of dominant GT onto nouns (lexical heads) as well as onto inner modifiers (inner dependents). This was seen in examples from Ijoid languages Kalabari and Izon, as well as several Dogon languages such as Jamsay. Row c. shows that an object can be a dominant trigger onto a verbal target. Although both of these are lexical heads, objects and verbs form a verb phrase, and as such the verb is the head of the construction (this will be discussed in a special section in 3.4.1.3 below). The opposite is not found, as shown rows d.-f.

The dominant GT asymmetry is important for two reasons. First, it stands at odds with the oft-cited preference for root faithfulness over affix faithfulness when the two are in competition (McCarthy & Prince 1995; Beckman 1998; Ussishkin & Wedel 2002; Krämer 2006; Urbanczyk 2011; Hall et al 2016:34), e.g. McCarthy & Prince’s (1995:364) universal meta-constraint ranking ROOTFOOTH above SUFFIXFAITH. A glaring counterexample to this are dominant effects of the type discussed here in grammatical tone.

Second, the dominant GT asymmetry corroborates Alderete’s (2001b:214) principle of **Strict Base Mutation**:

- (74) **Strict Base Mutation** (Alderete 2001b): alternations triggered by morphophonological operations are found exclusively in the stem (simplex or complex) which serves as the base of a morphological process

Alderete (2001a, 2001b) provides extensive empirical support for this claim from accentual systems. He concludes that the strict base mutation principle is a natural consequence of the fact that affixes can be dominant over roots but roots cannot be dominant over affixes. Similar conclusions are made in Inkelas (1998) for tone, which we fully corroborate with a larger sample. Taken all together, this speaks to a very strong asymmetry within morpho-phonemics which any model needs to capture.

### 3.4.1.2 Non-dominant triggers

In contrast to dominant triggers, non-dominant triggers do not show this asymmetry with respect to heads and dependents. A table showing the lack of neutral trigger asymmetries is in Table 21. Note that the sideways ‘n’ symbol  $\Rightarrow$  refers to triggering a non-dominant GT pattern. Gaps at the

far right are greyed out and marked n/a for ‘not available’. It is uncertain at this point whether they are accidental gaps or not.

	<b>Trigger</b>	<b>Target</b>	<b>Example</b>
a.	Affix	⇒ Root	<i>Hausa</i> (11)
	Affix <sub>OUT</sub>	⇒ [Affix <sub>IN</sub> -Root] <sub>stem</sub>	<i>Hausa</i> (37)
b.	Modifier	⇒ Noun	<i>Makonde</i> (46)
	Modifier <sub>OUT</sub>	⇒ [Modifier <sub>IN</sub> N]	<i>Jita</i> (75)
c.	Object	⇒ Verb	<i>Urarina</i> (80)
d.	Root	⇒ Affix	<i>Kabiye</i> (76)-(77)
	Affix <sub>IN</sub>	⇒ Affix <sub>OUT</sub>	n/a
e.	Noun	⇒ Modifier	<i>Urarina</i> (78)
	Modifier <sub>IN</sub>	⇒ Modifier <sub>OUT</sub>	n/a
f.	Verb (phrase)	⇒ Object	<i>Kuria</i> (81)

Table 21: Lack of non-dominant GT asymmetries

The triggers in rows a.-c. have been seen already in this chapter except for a neutral trigger outer modifier affecting an inner modifier + noun construction (b., second row). An example of this is given in (75) below from *Jita* (Bantu), in which nominal modifiers assign a H tone to the final TBU of the stem, whether it be a simple or complex base. In these examples, the outer modifier assigns a H tone to the inner modifier, which itself assigns a H tone to the noun.

(75)	Modifier <sub>OUT</sub>	⇒	[Modifier <sub>IN</sub> N]		
a.	/ oβu-ji thread ‘your red thread’	⊕	βu-mutuku red	⊕	βwa:ô / your → \ oβu- <b>ji</b> βu-mutu <b>ku</b> βw-a:ô \ [oβuji βúmutuku βwá:ô]
b.	/ li-twa:ngiro mortar ‘that heavy mortar’	⊕	li-sito heavy	⊕	li-lí:ya / that → \ li-twa:ngi <b>ró</b> li-si <b>tó</b> li-lí:ya \ [litwa:ngiro lísito lílí:ya]

[*Jita* – Downing 2006:105]

Further, rows d.-f. show that an more inner-located trigger (e.g. a lexical head or inner dependent) can assign a grammatical tune to an outer-located target (e.g. a dependent). One example involving a lexical head is *Kabiye* [kbp] (Roberts 2016). In *Kabiye*, a class/number grammatical suffix can be unvalued having no underlying tone /Ø/ (n=3), or valued having underlying /H/ (n=1), underlying /HL/ (n=2), or underlying /<sup>⊕</sup>L/ with a floating tone which overrides the tone on the final TBU of the root (n=4). In addition, roots have a number of tonal shapes several of which I analyze as having final floating tones, e.g. /H<sup>⊕</sup>/.<sup>12</sup> With suffixes with no underlying tone, the final T of the root spreads onto it or the final floating docks to it. This is shown in the column in (76) with the toneless suffixes CL3.SG /-U/ and CL12.SG /-ka/. Each one of the rows a.-d. has an example of a noun root with a floating tone and one without. For example, in b. compare /L/ /màzà-/ → \màzà-à\ ‘Saturday’ where the toneless affix gets low tone, to /L<sup>⊕</sup>/ /hùlà-/ → \hùlà-á\ ‘hat’ where it gets high tone.

In contrast, the last column with valued /<sup>⊕</sup>L/ suffixes show different patterns. Here, the floating tone from the root does not dock to it, but rather the floating tone associated affix docks

<sup>12</sup> Note that this portion is my analysis, not Roberts’; he simply renders this /HL/ if the root is monosyllabic and /HHL/ if bisyllabic.

to the root (schematically  $\text{AFFIX}^{\textcircled{1}} > \text{ROOT}^{\textcircled{1}}$ ). This therefore neutralizes the difference between the examples in each row, e.g. both /L/ and /L<sup>Ⓣ</sup>/ in row b. have an output tonal pattern \LHL\ when they occur with suffix /-<sup>Ⓣ</sup>sì/.

(76)	Underlying tone	/-Ø/	/- <sup>Ⓣ</sup> L/	Examples	CL3.SG /-U/ CL12.SG /-ka/	CL4.PL /- <sup>Ⓣ</sup> ṅ/ CL13.PL /- <sup>Ⓣ</sup> sì/
a.	/H-/	HH-H	H <sup>Ⓣ</sup> -L	náná- ‘bowl’	náná-á	nán-zi
	/H <sup>Ⓣ</sup> -/	HH- <sup>Ⓣ</sup>	H <sup>Ⓣ</sup> -L	wáá- ‘five year period’	wáá-à	wáá-sì
b.	/L-/	LL-L	L <sup>Ⓣ</sup> -L	màzà- ‘Saturday’	màzà-à	màzá-sì
	/L <sup>Ⓣ</sup> -/	LL- <sup>Ⓣ</sup>	L <sup>Ⓣ</sup> -L	hùlà- ‘hat’	hùlà-á	hùlá-sì
c.	/HL-/	HL-L	H <sup>Ⓣ</sup> -L	kpítà- ‘week’	kpítà-ò	kpítá-ṅ
				sákà- ‘porch’	sákà-à	sáká-sì
	/HL <sup>Ⓣ</sup> -/	HL- <sup>Ⓣ</sup>	H <sup>Ⓣ</sup> -L	kpíyò- ‘canoe’	kpíyò-ó	kpíyí-ṅ
				káǰà- ‘enclosure’	[kpí <sup>+</sup> yóú]	káǰá-sì
					káǰà-á	
					[ká <sup>+</sup> ǰáá]	
d.	/LH-/	LH-H	L <sup>Ⓣ</sup> -L	hèṅ- ‘crack’	hèṅ-á	hèṅ-zi
	/LH <sup>Ⓣ</sup> -/	LH- <sup>Ⓣ</sup>	L <sup>Ⓣ</sup> -L	kòò- ‘sacred place’	kòò-ká	kòó-sì

[Kabiye – Roberts 2016]

Additionally, /H/ suffixes such as CL6.PL /-lá/ (~-lá~-ná~-á) also do not take root floating tones, showing that this is not a quirk of having two floating tones. In (77) below, the difference between /H/ and /H<sup>Ⓣ</sup>/ is seen with the toneless suffix CL5.SG /-ǰE/: it bares \H\ tone with the former but \L\ tone in the latter. In contrast, this difference is not seen with the valued /-lá/. The floating tone does not dock to the root or the suffix, nor does it condition any tonological operation such as downstep (cf. (76) row c. above). The only complication involves all /L/ roots (row c.) which exceptionally cause /-lá/ to lower to -là. I assume that whatever causes this is orthogonal to floating tones, since the floating <sup>Ⓣ</sup> does not do this.

(77)

a.	H	/sóbó- + ǰE/	→	\sóbó-ǰé\	‘mosquito net’
		/sóbó- + lá/	→	\sóbó-lá\	‘mosquito nets’
	H <sup>Ⓣ</sup>	/púló- + ne/	→	\púló-nè\	‘drinking trough’
		/púló- + ná/	→	\púló-ná\	‘drinking troughs’
b.	LH	/ṅgí- + ne/	→	\ṅgí-né\	‘sorghum flour’
		/ṅgí- + ná/	→	\ṅgí-ná\	‘sorghum flours’
	LH <sup>Ⓣ</sup>	/kpàtá- + ǰE/	→	\kpàtá-ǰè\	‘raffia palm’
		/kpàtá- + lá/	→	\kpàtá-lá\	‘raffia palms’
c.	cf.				
	L	/tìm- + ǰE/	→	\tìm-ǰè\	‘large flute’
		/tìm- + lá/	→	\tìm-là\	‘large flutes’
	L <sup>Ⓣ</sup>	/nùù- + ǰE/	→	\nùù-ǰé\	‘piercing tool’
		/nùù- + lá/	→	\nùù-lá\	‘piercing tools’

[Kabiye – Roberts 2016]

Finally, /HL/ suffixes such as CL2.SG /-náà/ surface with \HL\ tones in all contexts, never receiving root tone either. Other complications exist detailed in Roberts, but none of these additional complications show something like floating tones overriding underlying suffixal tone.

I take this as illustrative of the behavior of floating tones on roots: they are always non-dominant in the sense that they do not automatically delete the underlying tone of a target-host. This predicts that any deletion which happens on the outer target-host should be ‘incidental’ in the sense that it is a consequence of general phonological restrictions in the language, or the result of non-automatic and exceptional properties of certain configurations. We therefore expect to never find the following situation as in Table 22, in which roots with floating tones (the ii. rows) dock to both unvalued suffixes /-Ø/ and also systematically override valued suffixes /-HL/ and /-<sup>⊕</sup>L/, i.e. are dominant. In line with previous predictions, such a system is unattested in my survey.

		Root tone	Suffix tone		
			/-Ø/	/-HL/	/- <sup>⊕</sup> L/
a.	i.	/H-/	HH-H	HH-HL	H <sup>⊕</sup> -L
	ii.	/H <sup>⊕</sup> -/	HH-⊕	HH-⊕	HH-⊕
b.	i.	/L-/	LL-L	LL-HL	L <sup>⊕</sup> -L
	ii.	/L <sup>⊕</sup> -/	LL-⊕	LL-⊕	LL-⊕
c.	i.	/HL-/	HL-L	HL-HL	H <sup>⊕</sup> -L
	ii.	/HL <sup>⊕</sup> -/	HL-⊕	HL-⊕	HL-⊕
d.	i.	/LH-/	LH-H	LH-HL	L <sup>⊕</sup> -L
	ii.	/LH <sup>⊕</sup> -/	LH-⊕	LH-⊕	LH-⊕

Table 22: Hypothetical tonal system predicted to *not* exist – Dominant roots with floating tones

In this Kabiye work, Roberts himself notes several examples of ‘word-tone languages’ in which tone sponsored from the root spreads onto neighboring morphemes, but only if they are unspecified for tone:

*“Word level tone, in various guises, is certainly common elsewhere in Africa and beyond. For example, Richards (1991: 56) identifies the domain of tone as the entire word in his analysis of Noone, Ncanti and Sali, three Beboid languages of Cameroon. Further afield, Donahue (1997), discussing Papuan, draws a typological distinction between syllable-tone languages, in which each syllable may bear a distinctive tone, and word-tone languages in which root tone patterns spread over the whole word, including toneless affixes. In Siane, for example, most suffixal and postclitic morphemes are unspecified for tone in their underlying representations and take their tones – H, L or LH – from the stem (James 1994: 128). Similar processes are attested in Gadsup (Pennington 2014), Kairi (Newman and Petterson 1990), Mian (Fedden 2012) and Narak (Hainsworth manuscript 1969).”*

[Roberts 2016:142; bolding mine]

Parallel patterns involving neutral triggers are found at the phrase level, e.g. Noun ⇌ Modifier. In Urarina [ura], nouns form one of four classes depending on where they place tone in the following word. Olawsky calls these types A, B, C, and D. One word class affected by nominal tonology are post-nominal modifiers such as adjectives, e.g. *lanahaj* /lana-ha-j/ ‘red’. A minimal pair is below, showing that type B noun assigns a H to the penult of the adjective, while type C assigns a H to the final.

(78) Noun ⇌ modifier

- a. Type B: *hjaané* ‘*achiote* tree’ + *lana-ha-j* ‘red’ → *hjaane lanáhaj* ‘red *achiote*’  
 b. Type C: *hjaané* ‘urine’ + *lana-ha-j* ‘red’ → *hjaane lanaháj* ‘red urine’

[Urarina – Olawsky 2006:122]

Important for our purposes is the fact that adjectives actually divide into a number of classes depending on their tonal behavior, shown below.

(79)	Adjective	After Type A	After Type B	After Type C	After Type D
a.	<i>laauhwiri</i> ‘small’	láauhwiri	laauhwíri	laauhwiri	laauhwiri
	<i>sěěohwa</i> ‘big’	sěěohwa	sěěóhwa	sěěohwá	sěěohwa
	<i>baaso</i> ‘bad’	báaso	baásô	baasó	baaso
b.	<i>nateásijne</i> ‘new’	natçásijne	natçásijne	natçasijné	natçasijne
c.	<i>kawateá</i> ‘good’	kawátça	kawátça	kawátça	kawatça
d.	<i>kawati</i> ‘good’	kawáti	kawáti	kawáti	kawáti
	<i>tabaj</i> ‘big’	tabáj	tabáj	tabáj	tabáj
	<i>tasínohwaj</i> ‘big’	tasínohwaj	tasínohwaj	tasínohwaj	tasínohwaj

[Urarina – Olawsky 2006:135]

The first class of adjectives is given in (79) row a., whose tonal behavior is entirely determined by the noun type which precedes it. After type A, the adjective gets a H on the initial, after type B on the penult, after type C on the final, and after type D none at all. In contrast, row b. and row c. show two classes of adjectives which do not conform to this behavior. In row b., this adjective surfaces with a H tone on the second TBU \nateásijne\ after noun types A and B, but is non-exceptional after types C and D. In row c., the adjective surfaces as \kawátça\ after types A, B, and C, but as toneless after type D. Finally, the adjectives in row d. uniformly have a H tone on the second TBU in all contexts and show no alternations.

From these data, we can reasonably assume that the adjectives in row a. are inherently toneless (unvalued) while those in row d. have inherent tone (valued). Nouns therefore assign tone to an unvalued adjective, but do not assign tone to a valued adjective, which retains its value in most cases. If we assume that the adjectives in rows b. and c. also have inherent tone on their second TBU and therefore are input as valued, the cells which are not explained are the three in grey after types C and D. I will not present any kind of analysis here, but merely note that they are the exception rather than the rule for [NOUN ADJECTIVE] tonology in Urarina. If the nouns were dominant triggers which automatically delete the underlying tone of a target-host, we would expect the opposite and likely only see underlying adjectival tonal values (if any) under other morphosyntactic contexts.

In chapter 2, I defined ‘grammatical tone’ as a ‘tonological operation which is not general across the phonological grammar, and is restricted to the context of a **specific morpheme or construction**’ (bolding for emphasis). Because the cases from Kabiye and Urarina involve something akin to floating tone sponsored from a lexical morpheme rather than grammatical one, it does not technically fit the definition of grammatical tone. However, I include it here to illustrate that all morphemes may sponsor a type of tonally deficient material (a toneme T without a TBU  $\tau$ , or vice versa), and that this may dock onto a neighboring host. It is the ability to be dominant which is restricted to outer elements, not the ability to sponsor tonemes which modify their tonological environment.

### 3.4.1.3 The special case of verb-object tonological asymmetries

In the tables above, I claimed that only objects can be dominant triggers and assign a grammatical tune to the verb (Table 20), but that either can be a neutral trigger of a tune onto the other (Table 21). Two neutral GT patterns are shown below.

- (80) Neutral trigger object with unvalued target-host verb
- GT pattern with noun type A – initial H on verb:  
/lureri<sup>Ⓣ</sup><sub>1</sub> + kwarakãu / → lureri **kwá** rakãu  
house see ‘I have seen the house’
  - GT pattern with noun type C – final H on verb:  
/komasaj<sup>Ⓣ</sup><sub>2</sub> + kwarakãu / → komasaj kwarakã**ú**  
wife see ‘I have seen the wife’

[Urarina - Olawsky 2006:128]

- (81) Neutral trigger verb (phrase) with unvalued target-host object
- GT to 3<sup>rd</sup> TBU of macrostem {[ ]]:  
/ <sup>Ⓣ</sup><sub>3</sub> + ntore {[koondokora]} / → ntore {[koo**ndókó**ra]}  
‘we will uncover (them)’
  - GT to 3<sup>rd</sup> TBU of macrostem {[ ]} + object:  
/ <sup>Ⓣ</sup><sub>3</sub> + ntore {[rya]} eyetóke / → ntore {[rya]} ey**étó**ke  
‘indeed we will eat a banana (then)’

[Kuria - Marlo, Mwita, & Paster 2014]

In (80) from Urarina, nouns have a floating tone after them which docks to a specific location, while verbs are inherently toneless (unvalued). In an object verb construction, the floating tone docks to the verb and no dominant patterns are seen. In (81) from Kuria [kuj], verbal inflection is partially indicated by floating tones. With both toneless verbs and toneless objects, this floating tone can dock to it and spread up to the penult. Here, it is a morpheme of the verb phrase which assigns non-dominant GT to the object.

There are few cases in the literature showing dominant GT interactions between object and verb, but of those which do exist, they reveal the [Object ► Verb] asymmetry. This can be of the replacive-dominant type – Gbarain Izon [ijc] in (82) where noun classes A, B, and C all assign a different tune to the verb – or of the subtractive-dominant type – Haya [hay] in (83) in which the complex set of tone patterns on objectless verbs are uniformly deleted when an object is present (if the verb is [-FOCUS] that is – see Hyman & Byarushengo 1984 for details).<sup>13</sup>

- (82) Replacive-dominant GT - Object ► Verb
- Noun tone class A: /bùrù<sub>A</sub> fě / → bùrù **fě** ‘buy a yam’
  - Noun tone class B: /námá<sub>B</sub> fě / → námá **fě** ‘buy meat’
  - Noun tone class C: /òró<sub>C</sub> fě / → òró **fě** ‘buy a mat’

[Izon - author fieldnotes]

- (83) Subtractive-dominant GT - Object ► Verb
- |                     |               |                           |
|---------------------|---------------|---------------------------|
|                     | ‘they tie up’ | ‘they tie up Kato’        |
| a. Present habitual | ba-kóm-a      | <b>ba-kom-a</b> Káto      |
| b. Past 1           | bá-á-kôm-a    | <b>ba-a-kom-a</b> Káto    |
| c. Past 2           | ba-kom-íl-e   | <b>ba-kom-il-e</b> Káto   |
| d. Past habitual    | ba-a-kóm-ag-a | <b>ba-a-kom-ag-a</b> Káto |
| e. Future 1         | ba-laa-kôm-a  | <b>ba-laa-kom-a</b> Káto  |
| f. Future 2         | ba-li-kóm-a   | <b>ba-li-kom-a</b> Káto   |

[Haya – Hyman 2009:228]

<sup>13</sup> Larry Hyman (p.c.) also informs me that the tones of the verb are deleted in contexts involving something else other than an object after it.



In general, it has been claimed that verbs have ‘reduced prominence in relation to their objects’ (e.g. Gussenhoven 2006). Not dealing with tone but rather abstract ‘prominence’ more generally, he notes the following generalization:

“[I]n languages generally it is not uncommon for verbs to have reduced prominence in relation to their objects. English, German and Dutch deaccent predicates in combination with arguments... (Gussenhoven 1983, 1992, Selkirk 1984, 1995), and Basque reduces the pitch range of final verbs in phrasal enclitics”

[Gussenhoven 2006:204]

Fleshing out exactly how the dominant GT patterns relates to this is left for future work. In chapter 6, I will argue that the [Object ► Verb] asymmetry falls out of the hierarchical relations of objects and verbs if we assume that objects are uniformly in specifier position.

The inverse dominant pattern is not found in my survey. A table illustrating the dominant GT asymmetry with respect to verb/object relations is below, whose structure mirrors that of Table 19 above.

GT type Trig. → Targ.		Non-dominant	Dominant
		Object → Verb	✓ Yes
Verb → Object	✓ Yes	* No	

Table 23: Dominant GT asymmetry w.r.t. verb/object relations

For instance, consider the following data from Bulu [bum] (Bantu - Clem 2014; supported by Yukawa 1992). Verbs may be /H/ or /L/. In [ VERB OBJECT ] constructions, the initial TBU of the object must match in tone with the final TBU of the verb in many tenses including past, recent past 2, and present tense. Note that this does not take place in other tenses (many of which involve assigning a H tone to the initial TBU of the object), or if the object appears with the augment (a Bantu term for a type of prefix, often associated with definiteness).

Table 24 illustrates this verb-object tone agreement in Bulu.<sup>14</sup>

Obj Verb	1	2	3	4	5
	/HL/ bíkòn plantains	/LH/ bilók grass	/LHH/ bitétám squirrel	/LHL/ bisíngì cats	/LLH/ òfùmbí orange
/L/ kùs ‘buy’	LL L màkùs bíkòn	LL LH màkùs bilók	LL LHH màkùs bitétám	LL LHL màkùs èsíngì	LL LLH màkùs òfùmbí
/H/ dží ‘eat’	LH HL màdží bíkòn	LH HL jàdží bilók	LH HLL màdží bitètám	LH HHL màdží bisíngì	LH HL màdží ófùmbí

Table 24: Verb-Object tone agreement in Bulu (Clem 2014:10)<sup>15</sup>

<sup>14</sup> This may be analyzed as as H tone spread. The exact analysis is orthogonal to the main point here.

<sup>15</sup> Translations: *màkùs bíkòn* ‘I am buying bananas’, *màkùs bilók* ‘I am buying grass’, *màkùs bitétám* ‘I am buying okra’, *màkùs èsíngì* ‘I am buying a cat’, *màkùs òfùmbí* ‘I am buying an orange’, *màdží bíkòn* ‘I am eating plantains’, *jàdží bilók* ‘(The cow) is eating grass’, *màdží bitètám* ‘I am eating okra’, *màdží bisíngì* ‘I am eating cats’, *màdží ófùmbí* ‘I am eating an orange’.

Verbs are at the left in blue and the objects are in red at the top, both split into tone classes. The output shapes all show that the final TBU of the verb and the initial TBU of the object match for tone. If they do not match in the input, the object tone changes, shown in blue and boxed. Columns 2 and 3 show that if the input is /LH(H)/ then the output is \HL(L)\, suggesting a ban against all high words. Column four shows that this is not an OCP violation as two highs appear adjacent in the output noun.

If verbs could be dominant over objects (i.e. [Verb ► Object]), then we would expect to find a language parallel to Bulu in all ways except showing the verb systematically deleting *all* underlying tones of the following object rather than merely docking a H to it, thereby neutralizing tonal contrasts. However, such a pattern is never found.

Verb	Object Tone									
	/HL/		/LH/		/LHH/		/LHL/		/LLH/	
	V	O	V	O	V	O	V	O	V	O
/L/	LL	<u>LL</u>	LL	<u>LL</u>	LL	<u>LLL</u>	LL	<u>LL</u>	LL	<u>LLL</u>
/H/	LH	<u>HH</u>	LH	<u>HH</u>	LH	<u>HHH</u>	LH	<u>HHH</u>	LH	<u>HHH</u>

Table 25: Non-attested hypothetical verb dominance over object

#### 3.4.1.4 Counter-examples of ‘outward dominance’?

Despite the robustness of these morphosyntactic asymmetries within my survey, there are a small number of surface counter-examples which I highlight here. In these cases, it appears that an lexical head is a dominant trigger over an outer dependent, contrary to expectations. I refer to these as exhibiting **outward dominance**. We can contrast **apparent outward dominance** with **true outward dominance**. I use the term ‘outward’ with the sense of moving outward from the root (lexical head) towards affixes and modifiers (dependents).

One apparent outward dominance case is from the Shanghai dialect of Wu Chinese [wuu] (see Chen 2000 and Zhang & Meng 2016 for references of the extensive literature). A tonological operation in Shanghai Wu called ‘left-dominant sandhi’ spreads the tone of the initial syllable across the entire word, replacing underlying tonal values (Zhang & Meng 2016:170, following Yue-Hashimoto 1987, Chen 2000, Zhang 2007, 2014). Here, ‘the tone on the second syllable is entirely determined by the tone on the first syllable and hence completely loses its contrastive status’ (Zhang & Meng 2016:171). An example from Zhang & Meng involve the verb /sã<sup>53</sup>/ ‘hurt’ is in (84)a. where the /53/ pattern (≈/HM/) spreads over the [VERB OBJECT] sequence and deletes the object tones. Another example is given in b. (Chen 2000), in which the verb /paq<sup>MH</sup>/ ‘give’ spreads over the indirect object and the pre-modifiers of the direct object (note the different but equivalent tonal conventions using numbers versus letters).

(84) Apparent outward dominance – Verb over object

- a. /sã<sup>53</sup>/ + /foŋ<sup>53</sup>/ → sã<sup>55</sup>-foŋ<sup>51</sup>  
‘hurt’ ‘wind’  
‘to catch a cold’
- b. /paq<sup>MH</sup>/ ngo<sup>LH</sup> yiq<sup>H</sup> pəŋg<sup>MH</sup> si<sup>HL</sup> / → paq<sup>M</sup> ngo<sup>□</sup> yiq<sup>□</sup> pəŋg<sup>□</sup> si<sup>HL</sup>  
give me one CLASSIFIER book  
‘give me a book’

[Shanghai Wu – a. Zhang & Meng 2016:170, citing Xu *et al.* 1981:151; b. Chen 2000:313]

Nearly all cases of ‘outward dominance’ upon close examination turn out to be apparent, such as this Shanghai Wu case. In this case, several cases of apparent outward dominance are attributed to their being a lexicalized unit (Zhang & Meng 2016, citing Xu *et al.* 1981):

“[M]odifier–noun combinations are invariably compounds and can only undergo left-dominant sandhi. **Verb–noun**, verb-modifier, subject–predicate combinations and coordinate structures that are **less lexicalized** and have **lower frequency** of occurrence, however, can undergo right-dominant sandhi, which retains the tone of the final syllable and reduces the tonal contour of the nonfinal syllable.”

[Shanghai Wu - Zhang & Meng 2016:170; bolding mine]

Furthermore, several researchers have commented on the complex interaction of metrical structure and tone sandhi of this deletion+spreading type. Yip (2002:111) notes ‘the domains are clearly stress domains, since they can be affected by contrastive stress, and are subject to clash avoidance’. Such a metrical analysis is thoroughly pursued in Chen (2000:306ff.), who argues for the following metrical structure of the Shanghai Wu in (85). The lexical items /paq<sup>MH</sup>/ ‘give’ and /si<sup>HL</sup>/ ‘book’ are stressed, while function words are inherently stressless. The stressed lexical words head left-prominent feet to which the function words cliticize. ‘Left-dominant sandhi’ is parasitic on this metrical structure whereby only the underlying tones of stressed syllables are preserved and subsequently spread across the foot (the underlying tone of function words can only be seen in contexts such as contrastive stress).

(85) Metrical analysis of ‘outward dominance’:

/paq <sup>MH</sup> ngo <sup>LH</sup> yiq <sup>H</sup> pəŋg <sup>MH</sup> si <sup>HL</sup> /	→	$\begin{matrix} ( & . & & & & & & & & & & x & ) \\ ( & x & & & & & & & & & & & ) \\ ( & \text{paq}^M & \text{ngo}^H & \text{yiq}^\emptyset & \text{pəŋg}^\emptyset & & & & & & & & ) \\ & & & & & & & & & & & & \text{si}^{HL} \end{matrix}$
give me one CLASSIFIER book		‘give me a book’

[Shanghai Wu – Chen 2000:313]

With these facts in mind, we can differentiate apparent and true outward dominance using the criteria as below.

Criterion	Apparent	True
a. Trigger:	Not specific to a natural class of triggers	Specific to a natural class of triggers
b. Position of prominence:	The ‘trigger’ is in a position of metrical prominence (e.g. stressed) and the ‘target’ is not	The trigger is <i>not</i> necessarily in a position of prominence
c. Domain of tonological operation:	The domain of the operation is a phonological constituent (e.g. prosodic foot, word, phrase, etc.)	The domain of the operation is <i>not</i> necessarily a phonological constituent
d. Phonological size of TRIGGER/TARGET:	The phonological size of the ‘trigger’ or ‘target’ affects the application of the operation (e.g. syllabicity)	The phonological size of the ‘trigger’ or ‘target’ does <i>not</i> affect the application
e. Floating tones & self-docking:	Does <i>not</i> lend itself to an analysis with floating tones; self-docking is expected	Lends itself to floating tones; self-docking is <i>not</i> expected

Table 26: Apparent versus true outward dominance

For Shanghai Wu, the ‘trigger’ can be many different types of lexical items head the left-dominant sandhi domain and therefore does not constitute a natural class, which according to the criterion in row a. makes it look like apparent outward dominance. Likewise, the trigger is in a position of metrical prominence and the target is not in such a position (b.), the domain of

operation is the foot (c.), the size of the constituents affects the application (d.) (Duanmu 1997), and there is no evidence for a floating tone analysis (e.), but rather the underlying tones of the TBU ‘spread out’ over the domain plus default tones towards the right edge (e.g. /HM/ on one TBU becomes [H M] on two TBUs).

The most convincing cases for true outward dominance is found in noun phrases in several Mande languages, typologized in Green’s (2018) overview of ‘tonale compacité’ in Mande. Within a noun phrase, typically the constituent on the right is affected by this tonal process, and in several cases this affected constituent is a modifier in a [NOUN MODIFIER] construction. Green discusses cases from Mande include Bandi [bza] and Loma [lom]; in both the tone of the adjective is overridden.

			/kòlè/ ‘white’	/kpèá/ ‘red’
a.	/nikà/	‘cow’	[nikà wòlé]	[nikà bèá]
b.	/pésô/	‘pencil’	[pésó wòlè]	[pésó bèà]
c.	/pèlé/	‘house’	[pèlé wólé]	n/a

Table 27: Bandi overwriting adjective tone

In this Bandi case, the contrastive tone on adjectives (/LL/ vs. /LH/) is neutralized in the context of a noun, e.g. [LH] in row a. compared to [LL] in b.

In chapter 6, I will highlight the most impressive potential case of outward dominance from Jalkunan [bxl] (Heath 2017), but ultimately argue against this interpretation. Note that in all of these Mande cases, substantial research is still required to properly assess their outward dominance patterns, which I leave for future study. They remain the most promising set of data which can falsify the typology (and later model) presented in this study.<sup>16</sup>

<sup>16</sup> One problem in assessing outward dominance is that in many cases it is not clear whether the trigger or target is more outward compared to the other. Consider the case of Jita which we have discussed quite a bit above. As in most Bantu languages, Jita has a series of morphological slots before and after the verb root:

Morphological slots of verb in Jita (Modified from Downing 1996:9)

-4	-3	-2	-1	0	+1	+2	+3
Subject Prefix	Negative Prefix	Tense/ Aspect	Object Prefix(es)	ROOT	Derivational Suffix(es)	Tense Marker	Final Vowel

Morphemes in these positions cause tonal changes either by class or idiosyncratically on neighboring morphemes. One such change is with the DISTANT PAST I, used to refer to actions or events which occurred before yesterday. This is exponed via the prefix /-a/ in slot [+2] jointly with the suffix /-íre/ in slot [+2]/[+3]. Examples are below from Downing (1996:181-183).

- (i.) / a-a-ká:ng-íre / → \ a-a-kara:ng-íre \ [a:kara:ngíre]  
 3SG-PST-fry-DIST.PST.I ‘s/he fried’
- (ii.) / a-a-βirim-íre / → \ a-a-βirim-íre \ [a:βirimíre]  
 3SG-PST-run-DIST.PST.I ‘s/he ran’
- (iii.) / a-a-βi-mir-íre / → \ a-a-βi-mir-íre \ [a:βimiríre]  
 3SG-PST-OM.CL9-swallow-DIST.PST.I ‘s/he swallowed it (CL.8)’

This suffix is subtractive-dominant in the sense that it deletes other tones in the verb, neutralizing the difference between high-toned (i.) and low-toned root (ii.). Important for our discussion is example (iii.) with a high-toned object marker /βi-/ ‘it (CL.8)’ in slot [+1]. This tone, too, is deleted in the context of dominant trigger /-íre/ and is therefore within its domain. Note that Jita is not a system with global culminativity: multiple H’s are normally permitted if non-adjacent.

### 3.4.2 Linear asymmetries with dominant triggers

My survey found no clear phonological asymmetries with respect to linear order for dominant GT. In Table 28 below, **anticipatory GT** involve constructions where the dominant trigger is to the *right* of the target, in rows a-c. **Perseverative GT** involve constructions where the dominant trigger is the *left* of the target, in rows d-f. Both of these are widely attested.

Anticipatory GT				Perseverative GT				
		L	R			L	R	
Tune		[	TARGET TRIGGER	]	Tune	[	TRIGGER TARGET	]
∅	a.	-AF	<i>Japanese</i> (14)		∅	d.	AF- n/a	
		W	<i>Makonde</i> (Table 18)			W	<i>Nkoroo</i> (chapter 2)	
<sup>Ⓟ</sup>	b.	-AF	<i>Hausa</i> (37): <sup>Ⓟ</sup> , <sup>Ⓛ</sup>		<sup>Ⓟ</sup>	e.	AF- <i>Japanese</i> (87): <sup>Ⓟ</sup>	
		W	<i>Tommo So</i> (44): <sup>Ⓛ</sup>			W	<i>Tommo So</i> (69): <sup>Ⓟ</sup>	
<sup>Ⓟ</sup> <sub>1</sub> <sup>Ⓟ</sup> <sub>2</sub>	c.	-AF	<i>Tommo So</i> (86): <sup>Ⓟ</sup> <sup>Ⓛ</sup>		<sup>Ⓟ</sup> <sub>1</sub> <sup>Ⓟ</sup> <sub>2</sub>	f.	AF- ( <i>Kukú</i> (?) (88): <sup>Ⓟ</sup> <sup>Ⓛ</sup> )	
		W	<i>Donno So</i> (Table 14): <sup>Ⓛ</sup> <sup>Ⓟ</sup>			W	<i>Kalabari</i> (12): <sup>Ⓛ</sup> <sup>Ⓟ</sup>	

Table 28: No linear asymmetries with dominant triggers

Rows a. and d. involve subtractive-dominance which deletes the tones of the target but does not replace it with a grammatical tune. [Note that for Nkoroo, this involves tone spreading of the trigger’s underlying tones to the first TBU of the target, discussed in chapter 2.] Rows b. and e. involve replacive-dominance which deletes the tones of the target and replaces it with a simplex grammatical tune involving a single toneme, e.g. a floating <sup>Ⓟ</sup>. Rows c. and f. involve a complex grammatical tune involving more than one toneme, e.g. a sequence <sup>Ⓟ</sup><sup>Ⓟ</sup>. In each row, the first row is morphologically bound morphemes (-AF for -AFFIX), and the second row is morphological independent words (W). Since the examples from Japanese (row e. of Table 28) and Tommo So (row c. of Table 28) were not given above, I provide them in (86)-(87) below.

(86) Dominant trigger suffix with complex tune -/<sup>Ⓟ</sup><sup>Ⓛ</sup>-dè/ IMPERFECTIVE in Tommo So<sup>17</sup>

	/T/	VERB	\ <sup>Ⓟ</sup> <sup>Ⓛ</sup> -dè \	‘s/he Vs/will V’
a.	gòó	exit	\ <b>gòó</b> -dè \	‘s/he exits/will exit’
	yóó	enter	\ <b>yóó</b> -dè \	‘s/he enters/will enter’
b.	ébé	buy	\ <b>ébé</b> -dè \	‘s/he buy/will buy’
	jòbó	run	\ <b>jòbò</b> -dè \	‘s/he runs/will run’
	jàà-ndá	cook	\ <b>jàà-ndà</b> -dè \	‘s/he cooks/will cook’
c.	kílémó	play	\ <b>kílèmò</b> -dè \	‘s/he plays/will play’
	gòròlól	snore	\ <b>gòròlò</b> -dè \	‘s/he snores/will snore’

[*Tommo So* – McPherson 2013:277]

(87) Replacive-dominant trigger prefix /ma<sup>Ⓟ</sup>-/ ‘truly’ in Japanese

a.	/ ma <sup>Ⓟ</sup> - + maru /	→	mam- <b>máru</b>	‘truly round’
	/ ma <sup>Ⓟ</sup> - + hiruma /	→	map- <b>píruma</b>	‘noon’
	/ ma <sup>Ⓟ</sup> - + sakasama /	→	mas- <b>sákasama</b>	‘truly downward’

If we interpret the morphological slots in the table above as a flat structure, it is not possible to determine if the trigger /-ire/ is the outer element of the two or if the object marker is, and therefore we cannot state if this is true outward dominance violating the dominant GT asymmetry. In such cases, we require further criteria which will be available on a case-by-case basis depending on the depth of literature for a language or family.

<sup>17</sup> Note that verb roots are only marginally contrastive for tone, and most ‘underlying’ tone can be predicted based on the first consonant.

- b. /ma<sup>Ⓣ</sup>- + kurá(+i) / → mak-kúra ‘truly dark’  
 /ma<sup>Ⓣ</sup>- + syoomén / → mas-syóomen ‘truly face-to-face’

[Japanese – Kawahara 2015:470, citing Poser 1984]

Note the gaps in my survey (cells in light grey), for which I do not have data. At this point I have no reason to suspect that these triggers are anything but accidental gaps given worldwide dispreference for prefixes versus suffixes, gaps which will be filled in given further typologizing. I suspect that upon further analysis of verbal inflection systems involving GT, cases of a prefix assigning a complex grammatical tune will emerge. One potential case of a prefixal trigger with a complex <sup>ⓉⓉ</sup> pattern is in Kukú [bfa] (Nilotic – Cohen 2000:30-31), shown in (88) below. Here verb roots have a lexical /H/ or /LHL/ pattern, a contrast maintained in most suffixal context (b.-c.). However, Cohen notes that ‘every morphological pattern that involves prefixing segmental material to the verb root...neutralizes the contrast between H and LHL roots’ (with the exception of certain reduplicative patterns) (p. 31), shown below in d.-e. with prefixes /tV-<sup>ⓉⓉ</sup>/ CAUSATIVE and /kò-<sup>ⓉⓉ</sup>/ ‘don’t’. I include this as a tentative example because it is unclear whether the prefixes assign the grammatical tune, or whether they merely neutralize the differences and the /LHL/ verb pattern applies by default.

(88) Potential case of a prefixal trigger with a complex tune

	<u>/LHL/</u>		<u>/H/</u>		
a.	mét	‘look’	=	dér	‘cook’
b.	mèd-dâ	‘look+QUAL’	≠	dér-jà	‘cook+QUAL’
	mèt-àrà?	‘look away’	≠	dér-àrà?	‘cook away’
	mèt-ón	‘look towards’	≠	dér-ón	‘cook towards’
	mèt-â	‘be seen’ (PASS)	≠	dér-â	‘be cooked’ (PASS)
c.	mèt-ê	‘look!’	≠	dér-é	‘cook!’
Cf.					
d.	tò- <b>mêt</b>	‘cause to see’	=	tò- <b>dêr</b>	‘cause to cook’
e.	kò- <b>wê?</b>	‘don’t smear!’	=	kò- <b>kêp</b>	‘don’t follow!’
	kò- <b>sípùk</b>	‘don’t invert!’	=	kò- <b>gbúrik</b>	‘don’t thatch!’

[Kukú – Cohen 2000:30-31,54]

### 3.5 Grammatical tone beyond dominance effects

Several types of grammatical tone cases do not easily lend themselves to the typology I have sketched above involving dominance effects. This comes from the fact that it largely rests on the idea of (1) grammatical tone is morphological exponence, and (2) that there are identifiable components which we can label as ‘trigger’, ‘target’, and ‘grammatical tune’ which are consistent across parallel grammatical contexts. I will highlight several of these here, which I do not intend to be an exhaustive list.

By listing these phenomena, I do not want to indicate that they definitively cannot be incorporated in the typology above, or indicate that they definitively cannot be analyzed within the theory I propose in the next chapter. Future work will be required to assess this properly. In this section, I simply wish to highlight the outer limits of grammatical tone, and compare it against the typology sketched above. This will include the following:

- (89) Beyond dominance effects: the outer limits of grammatical tone
- a. Construct tunes
  - b. Paradigmatic GT
  - c. Grammatical tone sandhi

d. Scalar shifts

3.5.1 Construct tunes

One example of GT which goes beyond our discussion is the existence of what I call **construct tunes**, which are found when GT expones case or is licensed in the so-called ‘construct state’. Case transparently refers to familiar morphosyntactic case (e.g. ergative, nominative, etc.), while ‘construct state’ refers to phonological alterations to the root shape (whether noun, verb, or adjective) in specific grammatical contexts, e.g. a noun modified by a demonstrative. I treat GT case and construct states together as they are often difficult to disentangle (e.g. the genitive case), while also occurring in the same area of northern East Africa. The alterations in the tonal shape of the root are what the term ‘construct tune’ refers to.

It is evident that construct tunes resemble the cases of GT introduced throughout this study, and appear to function in a similar role in cuing particular grammatical meaning. However, this tonal phenomenon shows several characteristics which can distinguish it, including the following:

- (90) Characteristics of construct tunes
- a. Case and/or construct state is expounded only through tone, namely the construct tune, with no segmental affixes
  - b. The construct tune is only partially predictable from the input; both tonologically-conditioned and lexically-conditioned grammatical allotunes are common
  - c. The construct tune affects only the root and not other morphemes/words within the grammatical context
  - d. Other ‘targets’ within the grammatical context bare their own, distinct construct tune (or by hypothesis are transparent or opaque, and retain their underlying tones)
  - e. Roots have only one construct tune shape in the construct state, regardless of their grammatical context

The use of the term ‘construct state’ is common in the Semitic literature and has been extended to a wide variety of grammatical tone changes in Creissels (2007), going well beyond the narrow set of characteristics here.

We have already seen several cases of construct tunes involving case and construct state. A sample of East African languages from different families is below.

(91)	Language	ISO	Type	Example	Source
a.	Ganza	[gza]	‘Construct state’	Table 29	[Mao – Smolders 2016]
b.	Northern Mao	[myf]	Modified noun		[Mao – Ahland 2012]
c.	Jumjum	[jum]	Modified noun	Chapter 2	[Nilotic - Andersen 2004]
d.	Maasai	[mas]	Nominative case		[Nilotic - Tucker & Mpaayei 1955]
e.	Tugen	[tuy]	Nominative case	Table 17	[Nilotic - Jerono 2013]
f.	Gaahmg	[tbi]	Genitive case	Table 16	[Eastern Sudanic - Stirtz 2011]

For example, modified nouns in Jumjum become all L tone in the output (row c.), while in the Tugen case (row e.), there were at least 15 input-to-output mappings which changed the tone in largely unpredictable ways. In this area, it is also common for there to be complex tonal changes on nouns to indicate plurality, e.g. in Ik [ikx] from (54), a genetically unrelated Kuliak language.

I will illustrate certain of the properties of this phenomenon using Ganza (Smolders 2016), part of the small Mao family included within the Omotic group. Roots in Ganza have underlying

tone which include combinations of /L/, /H/, and equivalent floating tones. In the table below illustrating nouns, the tone patterns are grouped based on how what construct tune they take in ‘construct states’, which are a set of grammatical environments. Smolders notes that “for nouns and adjectives this alternative melody [=construct tune] is applied when the word is modified, whether by another noun, a demonstrative, a possessive pronoun, etc.” (p. 130).

In the table, row a. shows nouns which take an all L construct tune in a construct state, e.g. shown in columns 5 and in context in column 7 in the PLURAL DISTAL DEMONSTRATIVE construction. Row b. show nouns which take a HL construct tune in these same contexts, and row c. shows nouns which take a H<sup>Ⓛ</sup> tune with a floating low tone which docks to the following morpheme. The three construct tunes have in common that they end in a low tone, but otherwise cannot be fully predicted. For example, underlying H<sup>Ⓛ</sup> maps to construct tunes L or H<sup>Ⓛ</sup> depending on the noun (compare mapping 3 to mapping 8); similar facts hold for underlying H<sup>+</sup>H (cf. mappings 7 and 10). The data illustrates that the construct tune is phonologically and lexically conditioned.

	1	2	3	4	5	6	7
	Construct tune	Citation	Translation	Underlying T	Construct tune	+Plural (Underlying)	+Pl distal dem. (Construct)
a.	1 H → L	[gánjá]	‘donkey’	gánjá	gànjà	gánjá-gù	ʔùgù gànjà-gù
	2 L → L	[k <sup>h</sup> ùrù]	‘genet’	kùrù	kùrù	kùrù-gù	ʔùgù kùrù-gù
	3 H <sup>Ⓛ</sup> → L	[t’úlâ]	‘dikdik’	t’úlâ <sup>Ⓛ</sup>	t’ùlà	t’úlâ-gù	ʔùgù t’ùlà-gù
	4 LH → L	[mìimí]	‘mosquito’	mìimí	mìimì	mìimí-gù	ʔùgù mìimì-gù
	5 LH <sup>Ⓛ</sup> → L	[k <sup>h</sup> jàlá]	‘colobus’	kjàlá <sup>Ⓛ</sup>	kjàlà	kjàlá-gù	ʔùgù kjàlà-gù
b.	6 HL → HL	[p <sup>h</sup> ádâ]	‘deer’	pát’â	pát’â	pát’â-gù	ʔùgù pát’â-gù
	7 H <sup>+</sup> H → HL	[sá <sup>+</sup> ʔá]	‘goat’	sá <sup>+</sup> ʔá	sáʔà	sá <sup>+</sup> ʔá-gù	ʔùgù sáʔà-gù
c.	8 H <sup>Ⓛ</sup> → H <sup>Ⓛ</sup>	[sásô]	‘monkey’	sásô <sup>Ⓛ</sup>	sásô <sup>Ⓛ</sup>	sásô-gù	ʔùgù sásô-gù
	9 L <sup>Ⓛ</sup> → H <sup>Ⓛ</sup>	[wàṅà]	‘chicken’	wàṅà <sup>Ⓛ</sup>	wàṅá <sup>Ⓛ</sup>	wàṅà-gù	ʔùgù wàṅá-gù
	10 H <sup>+</sup> H → H <sup>Ⓛ</sup>	[k <sup>h</sup> á <sup>+</sup> ná]	‘dog’	ká <sup>+</sup> ná	káná <sup>Ⓛ</sup>	ká <sup>+</sup> ná-gù	ʔùgù káná-gù

Table 29: Construct tune in Ganza nouns (Smolders 2016:133)

Verbs also have construct tune shapes, licensed in particular grammatical settings. Two patterns illustrate construct tune characteristics. First, construct tunes on verbs are licensed in an idiosyncratic set of grammatical environments. For example, verbs bear their underlying tones with the verbal clitic /=bo/ VC1 but bear their construct tune form with the verbal clitic /=na/ VC2, clitics which otherwise have very similar meaning. In serial verb constructions, the verbs ‘agree’ in the sense that they all appear with their underlying tones as in (92)a., or all appear in with their construct tunes as in b.

(92) Construct tune ‘agreement’

a. Serial verbs with underlying tones:

LH + H<sup>+</sup>H + L<sup>Ⓛ</sup>

[ t’úmán p<sup>h</sup>ádâdì p’òfó k<sup>h</sup>í<sup>+</sup>ʔá jèppô ]

/ t’úmán pát’â=di p’òfó kí<sup>+</sup>ʔá jèp’<sup>Ⓛ</sup>=bo /

yesterday deer=1SG.SBJ chase catch kill=VC1

‘yesterday I chased, caught, and killed a deer’



b. Serial verbs with construct tunes:

L + HL + L

[ t'úmán p<sup>h</sup>ádãdì p'òfò k<sup>h</sup>í?à jèp'nà ]

/ t'úmán pá't'à=di p'òfò kí?à jèp'=na /

yesterday deer=1SG.SBJ chase catch kill=VC2

'yesterday I chased, caught, and killed a deer'

[Ganza – Smolders 2016:138]

Such cases where grammatical tone is 'individuated' across morphemes within the target domain of a trigger are not attested in my survey, where the common pattern is for the grammatical tune to 'spread out' over the entire target domain, or dock to just one (local) morpheme.

Second, as mentioned above it is an idiosyncratic property of a particular morpheme or construction whether it triggers construct tune or not. This is summarized in Table 30 below, adapted from the description in Smolders (2016).

	Construction	Morpheme(s)	Stem	Tune	
a.	Jussive	kwámañ	Free	Full	Underlying
	Continuous auxiliary	gára <sup>Ⓛ</sup>	Free	Reduced	Agreement
b.	Verbal clitic 1	=bo	Clitic	Reduced	Underlying
	Verbal clitic 2	=na	Clitic	Reduced	Construct
c.i.	Non-final SS	-p	Suffix	Full	Underlying
	Negative	-án <sup>Ⓛ</sup>	Suffix	Full	Underlying
	Negative imperative	-án <sup>Ⓛ</sup> + -éj/-èm	Suffix	Full	Underlying
	Conditional	-n	Suffix	Full	Construct
	Non-final DS	-l	Suffix	Full	Agreement
	Perfect	-gwá <sup>Ⓛ</sup>	Suffix	Full	Agreement
	c.ii.	Nominalized	-di	Suffix	Reduced
Imperative		-éj/-èm	Suffix	Reduced	Underlying
Content question		-e	Suffix	Reduced	Underlying
Future / purpose		-sa	Suffix	Reduced	Construct
Relative clause		-di	Suffix	Reduced	Construct
Reason		-di + kódò	Suffix	Reduced	Construct
d.		Polar question	Ø	Null	Reduced
	Serial verb	Ø	Null	Full	Agreement

Table 30: Verbal constructions in Ganza (Adapted from Smolders 2016:121,138)

The morphemes which modify verbs are organized into whether they are independent words (free), whether they are clitics or suffixes, or whether they form a morphosyntactic construction (null). These are split up into four groups a.-d. respectively. Each verbal constructions will license either a 'full' form of the verbal stem or a 'reduced' form with elision of the final vowel and vocalic ablaut. For example, the verb /swáná/ (full) versus /swén/ (reduced), 'to count'. This process is not predictable, e.g. the verb /sásá<sup>Ⓛ</sup>/ 'to bite' does not have a reduced form. Due to these facts, Smolders analyses the reduced form as an allomorphic stem. Finally, each verbal construction also licenses either the underlying tune, the construct tune, or exhibits agreement depending on other grammatical factors in the context, such as the serial verb construction in (92) above.

The important take away from this table is that whether a verbal construction takes the full or reduced form of the stem and whether it takes the underlying or construct tune are orthogonal

and cross-cut across the verbal paradigm. A simple example is below highlighted from Smolders showing that the four surface forms of the verb ‘to count’.

(93)

	<b>‘to count’</b>	<b>Underlying</b>	<b>Construct</b>	<b>Context</b>	<b>Underlying</b>	<b>Construct</b>
a.	Full	swáná <sub>1</sub>	swàná <sub>2</sub>	Full	NEGATIVE -án <sup>Ⓣ</sup> <sub>1</sub>	CONDITIONAL -n <sub>2</sub>
b.	Reduced	swén <sub>3</sub>	swèn <sub>4</sub>	Reduced	IMPERATIVE -éǝ <sub>3</sub>	FUTURE -sa <sub>4</sub>

[Ganza – Smolders 2016]

These data bear on how one should interpret the construct tune, including at least two possibilities. One is that it is a grammatical tune licensed by a trigger, albeit one with more specified properties than the GT cases seen throughout this typology. Triggers of the construct tune would be dominant (overriding underlying tone), and would all trigger the same set of grammatical allotunes which are tonologically and lexically conditioned, with the only suitable host being a root (all other morphemes being indomitable). A second possibility is that the form with construct tune is actually a stored allomorph and therefore there is no actual tonological operation, akin to the analysis of tonal allomorphy defined in chapter 2. I view it as a special form of the first case. Recall that while all forms are subject to receiving construct tune if they have the requisite tonal properties, not all forms have a reduced stem form, which lends support for the former type being a dynamic process while the latter type being selection of a stored unit. Further, Smolders notes that a verb root can have a distinct reduced form, a distinct construct tune, both, or neither, shown in rows 1-4 in Table 31 below.

1	‘to count’	Underlying	Construct	Context	Underlying	Construct
	Full	swáná	swàná <sup>Ⓣ</sup> <sub>[+C]</sub>	Full	∅	[+C]
	Reduced	swén <sub>[+R]</sub>	swèn <sub>[+R,+C]</sub>	Reduced	[+R]	[+R,+C]
2	‘to cross over’	Underlying	Construct	Context	Underlying	Construct
	Full	sú <sup>+</sup> nú	súnú <sup>Ⓣ</sup> <sub>[+C]</sub>	Full	∅	[+C]
	Reduced			Reduced		
3	‘to burn’	Underlying	Construct	Context	Underlying	Construct
	Full	sápá <sup>Ⓣ</sup>		Full	∅	
	Reduced	sáp <sup>Ⓣ</sup> <sub>[+R]</sub>		Reduced	[+R]	
4	‘to bite’	Underlying	Construct	Context	Underlying	Construct
	Full	sásá <sup>Ⓣ</sup>		Full	∅	
	Reduced			Reduced		
*5	NOT ATTESTED	Underlying	Construct	Context	Underlying	Construct
	Full	*sánà	*sànà <sub>[+C]</sub>	Full	∅	
	Reduced	*sén <sub>[+R]</sub>		Reduced	[+R]	[+C]

Table 31: Ganza verb types

Importantly, there is no form like row 5 where there are full and reduced forms with underlying tone only, whereas with the construct tune there is only a full form. If we assumed that all four units were allomorphs, then we would expect that we could find patterns such as row 5, contrary to fact. If, however, we assume that the full versus reduced stem were allomorphic but that construct tune applied after allomorphy insertion, then the forms in row 5 would not be possible and their gap would be accounted for.

Regardless of which possibility proves to be best supported, it is sufficient for our purposes to establish that construct tunes are a special case of grammatical tune distinct from other cases.

### 3.5.2 Paradigmatic GT

Another type of non-canonical grammatical tone is what I call **paradigmatic GT**:

- [Def 11] **Paradigmatic GT**: In a grammatical paradigm consisting of grammatical categories, tonal values to the root/stem which
- (i) show extensive inconsistency within grammatical categories (no paradigmatic consistency across rows or columns), and
  - (ii) show extensive inconsistency across roots/stems in parallel paradigms (no ‘transparadigmatic’ consistency across rows or columns), and
  - (iii) there being little positive evidence for determining the underlying tone of the root/stem

This is strictly speaking only a descriptive term and does not refer to a coherent phenomenon differentiating from the other cases. If the threshold for ‘extensive inconsistency’ is quite low, then several cases of GT may correspond to paradigmatic GT.

Palancar’s (2016) typology of the inflectional use of tone refers to several types which we can classify as paradigmatic GT. One is what he calls ‘morphological tone linked to the lexicon’ (p. 123), in which tone is ‘tightly and intricately linked to the lexicon’, and a second is what he calls ‘tonal classes’, whereby morphological inflectional classes derive entirely from sets of tonal changes across grammatical paradigms. Following from his discussion, one case of paradigmatic GT involves Yaitepec Chatino [ctp] (Otomanguean – Rasch 2015), which has the following 10 tonemes:

#### (94) Tonemes in Yaitepec Chatino

- |         |                           |         |                               |
|---------|---------------------------|---------|-------------------------------|
| a. /1/  | High with a slight rising | f. /21/ | Lower high rising             |
| b. /2/  | Lower high                | g. /23/ | Lower high falling            |
| c. /3/  | Mid                       | h. /24/ | Lower high with sharp falling |
| d. /12/ | High falling              | i. /31/ | Mid rising                    |
| e. /14/ | High with sharp falling   | j. /43/ | Low rising                    |

These tonemes play a major role in expressing grammatical categories, shown in the three mini-paradigms in Table 32. The rows denote aspect-mood values while the columns denote subject agreement for person. Each of these paradigms is different for the three verbs. Row set a. illustrates that the segmental shape of the verb stem is consistent within aspect-mood, e.g. *xnu* is [nxnu] in all habitual contexts. Row sets b. and c. schematize the tonal values of each cell. For the first verb, we see there tone exclusively covaries with person, but that with the second and third verbs there are several surface tones within each column. In the third verb, in fact, tone exclusively covaries with progressive aspect-mood rather than subject.

Further, row set c. schematizes transparadigmatic comparison across counterpart cells. Those cells which are distinct compared to its counterparts are in red within light grey. For

example, 1<sup>st</sup> habitual for the latter two verbs is [3] but is [21] for the first verb; therefore the first verb’s cell is marked as distinct. We see that all verbs exhibit both transparadigmatic consistency and inconsistency in expressing grammatical categories via tone, with Palancar concluding in cases like that that such paradigms reveal “no evident consistent mapping between form and meaning” (p.130), a cornerstone of item-and-arrangement theories of exponence.

<i>xnu</i> ‘leave behind’				<i>swi</i> ‘choose’			<i>jwi</i> ‘kill’		
a.	1 <sup>st</sup>	2 <sup>nd</sup>	3 <sup>rd</sup>	1 <sup>st</sup>	2 <sup>nd</sup>	3 <sup>rd</sup>	1 <sup>st</sup>	2 <sup>nd</sup>	3 <sup>rd</sup>
HAB	nxnu <sup>21</sup>	nxnu <sup>31</sup>	nxnu <sup>1</sup>	nswi <sup>3</sup>	nswi <sup>31</sup>	nswi <sup>43</sup>	ntyjwi <sup>3</sup>	ntyjwi <sup>31</sup>	ntyjwi <sup>24</sup>
POT	xnu <sup>21</sup>	xnu <sup>31</sup>	xnu <sup>1</sup>	swi <sup>3</sup>	swi <sup>31</sup>	swi <sup>43</sup>	kjwi <sup>3</sup>	kjwi <sup>31</sup>	kjwi <sup>24</sup>
CPL	nwxnu <sup>21</sup>	nwxnu <sup>31</sup>	nwxnu <sup>1</sup>	nswi <sup>3</sup>	nswi <sup>31</sup>	nswi <sup>1</sup>	yjwi <sup>3</sup>	yjwi <sup>2</sup>	yjwi <sup>12</sup>
PROG	nxnu <sup>21</sup>	nxnu <sup>31</sup>	nxnu <sup>1</sup>	nswi <sup>2</sup>	nswi <sup>31</sup>	nswi <sup>1</sup>	ntjwi <sup>2</sup>	ntjwi <sup>2</sup>	ntjwi <sup>2</sup>

b.	1 <sup>st</sup>	2 <sup>nd</sup>	3 <sup>rd</sup>	1 <sup>st</sup>	2 <sup>nd</sup>	3 <sup>rd</sup>	1 <sup>st</sup>	2 <sup>nd</sup>	3 <sup>rd</sup>
HAB	21	31	1	3	31	43	3	31	24
POT						1		2	12
CPL				2					
PROG				2					

c.	1 <sup>st</sup>	2 <sup>nd</sup>	3 <sup>rd</sup>	1 <sup>st</sup>	2 <sup>nd</sup>	3 <sup>rd</sup>	1 <sup>st</sup>	2 <sup>nd</sup>	3 <sup>rd</sup>
HAB	21	31	1	3	31	43	3	31	24
POT	21	31	1	3	31	43	3	31	24
CPL	21	31	1	3	31	1	3	2	12
PROG	21	31	1	2	31	1	2	2	2

Table 32: Paradigmatic GT in Yaitepec Chatino (Palancar 2016:131, citing Rasch 2015)

Verbs form at least 75 distinct tonal paradigms in Yaitepec Chatino (detailed in Palancar 2016:135-137), which makes it look quite exotic compared to tonal patterns encountered thus far, but is demonstrative of paradigmatic tone as found in this family and linguistic area.

As we discussed with construct tunes, we may analyze the tonal alternations in Paradigmatic GT as a dynamic process or as allomorphic storage plus selection in particular grammatical contexts. I leave this issue aside here, but note that it would be impossible to analyze these data without some degree of (tonal) allomorphy. See the discussion in Palancar addressing this issue, situating it within the morphological literature.

### 3.5.3 Grammatical tone sandhi

We defined tone sandhi in Chapter 2 as not being an example of grammatical tone because it is phonologically rather than grammatically conditioned. In several cases, however, a tonal phenomenon has the characteristics of tone sandhi except that it occurs only in a highly restricted grammatical context or set of contexts. I refer to this as **grammatical tone sandhi**.

One case is Seenku [s<sub>os</sub>] (Mande – McPherson 2016, 2017a, 2017b), which has four tone heights: extra high /eH/ <  $\hat{\tau}$  >, high /H/ <  $\hat{\tau}$  >, low /L/ <  $\check{\tau}$  >, and extra low /eL/ <  $\check{\tau}$  > (note that <  $\hat{\tau}$  > = a contour /HeL/). In the inalienable genitive construction [ POSSESSOR NOUN ], if the possessor is a pronoun then the tones of the noun change, e.g. /nĩ/ ‘father’ → /mó nĩ/ ‘my father’ with the emphatic first singular /mó/. Such changes only take place in this context, and therefore can be said to cue the grammatical category GENITIVE. Importantly, however, tonal changes in this context are only predictable based on the phonological value of *both* the pronominal possessor (the trigger) and the noun (the target), and not based on a grammatical feature. The table below illustrates the changes:

	Noun			
Pronom. possessor		/ eL /	/ H /	/ eH /
a. / eL /		eL eL	eL eL	eL H
b. / H /		H eH	H eL	H eL
c. / eH /		eH eH	eH eH	eH eH

Table 33: Grammatical tone sandhi in Seenku [PRONPOSS NOUN] construction (McPherson 2016)

Like in the cases of paradigmatic GT, there is incomplete consistency across the paradigm: although /eH/ pronouns trigger spreading of their tone (also attested with nominal possessors), the other values do not exhibit this. However, there is transparadigmatic consistency by virtue of the patterns being phonologically conditioned without lexical conditioning, which patterns like tone sandhi. McPherson acknowledges the difficulty in classifying this phenomenon, noting that:

*“There is no apparent unifying mechanism behind these tonal changes: no pressures like antihomophony between underlying and possessed tone (eL remains eL after eL) or avoidance of neutralization of lexical tone (everything neutralizes after eH, two tones neutralize after both eL and H), no simple spreading, assimilation, or dissimilation. In this paper, I treat the changes as paradigmatic morphology or constructional changes similar to the notion of the “construct state” [Creissels 2007], though future work could reveal phonological principles underlying the system.”*

[Seenku - McPherson 2016]

A similar case of grammatical tone sandhi is found in Supyire [spp] (Senoufo – Carlson 1994), which although not closely related belongs to the same geographic proximity in West Africa.

I classify as grammatical tone sandhi only those cases where the tonal value of both the trigger and the target are necessarily referred to in the tonal change. This excludes superficially similar cases where the tonal operation takes place regardless of and without reference to the tonological value of the trigger or target. We saw an example of this above from the ‘nominalizer tone circle’ in the Cushillococha dialect of Ticuna [tca] (Isolate – Skilton 2017:47-56), with five vowel heights. Here, there are a complex set of tonal changes which are only conditioned by a set of productive ‘class nominalizers’ /-(?)e<sup>3</sup>/ CLASS.I.NMLZ, /-(?)ki<sup>3</sup>/ CLASS.II.NMLZ, /-ʔi<sup>5</sup>ne<sup>1</sup>/ CLASS.III.NMLZ, and /-ʔi<sup>4</sup>/ CLASS.IV.NMLZ. Some examples are provided below (for the complete circle, see Figure 3):

(95) Grammatical tone sandhi in Ticuna (Skilton 2017)

- a. / T1 / → \ T2 \ preceding Class IV nominalizer trigger /-ʔi<sup>4</sup>/
- i. / te<sup>1</sup> / ‘be sharp’  
/ 1 / → \ 5 \  
/ na<sup>1</sup>=te<sup>1</sup>-ʔi<sup>4</sup>=ka<sup>1</sup> / → \ na<sup>1</sup>te<sup>5</sup>ʔi<sup>4</sup>ka<sup>1</sup> \ ‘so that it is sharp’
  - ii. / mū<sup>4</sup> / ‘be numerous’  
/ 4 / → \ 1 \  
/ na<sup>1</sup>=mū<sup>4</sup>-ʔi<sup>4</sup>=ka<sup>1</sup> / → \ na<sup>1</sup>mū<sup>1</sup>ʔi<sup>4</sup>ka<sup>1</sup> \ ‘so that they are numerous’
  - iii. / ā<sup>3</sup> / ‘give’  
/ 3 / → \ 2 \  
/ wi<sup>4</sup>ʔi<sup>4</sup> i<sup>4</sup> ā<sup>3</sup> ʔi<sup>4</sup> / → \ wi<sup>4</sup>ʔi<sup>4</sup> i<sup>4</sup> ā<sup>2</sup> ʔi<sup>4</sup> \ ‘one (CL.IV) that gives’

- b. /T1/ → \T2\ preceding Class II nominalizer trigger /-(?)ki<sup>3</sup>/  
 /pu<sup>3</sup>/ ‘rain’  
 /3/ → \2\  
 /wi<sup>43</sup>ʔi<sup>4</sup> Ja<sup>4</sup> pu<sup>3</sup> ki<sup>3</sup>/ → \wi<sup>43</sup>ʔi<sup>4</sup> Ja<sup>4</sup> pu<sup>2</sup> ki<sup>3</sup>\ ‘a (period of) rain’

With few exceptions, Skilton notes that all class nominalizers trigger the tonal circle regardless of their tonal value which could be /3/, /4/, or /5/; compare (95)a.iii. and b. above. Therefore, although the tonal value of the target plays a role in the tonal operation, the value of the trigger does not, and I consequently do not classify it as ‘grammatical tone sandhi’.

### 3.5.4 *Scalar shifts*

The last grammatical tone phenomenon I will discuss is **scalar shifts**. In languages with 3 or more tone heights, a particular construction can trigger a series of tonal shifts upward or downward in height, i.e. a series of changes {/5/→\4/, /4/→\3/, /3/→\2/, /2/→\1/, /1/→\1\}. Several cases have been reported in West African languages, e.g. Guebié [gie] (Kru – Sande 2017), Gban [ggu] (Mande – Zheltov 2005:24), and Seenku [sos] (Mande – McPherson 2016). Scalar shifts frequently involve 3-height tone languages with vacuous application at the top or bottom height, e.g. downward in Noni [nhu] where /H/ → \M\ and /M/,L/ → \L\ in the grammatical context of the suffix /-tè/ PROGRESSIVE (Hyman 1981a:41-50) but upward in Karbi [mjw] where /L/→\M\ and /M,H/→\H\ triggered by prefixes *che-* RR ‘on one’s own’ and *cho-AUTO.BEN/MAL* ‘for oneself’ (Konnerth 2014:100). For Guébie, Sande presents a more complex situation whereby imperfective aspect is expressed via a scalar shift, but results in the introduction of a new toneme \5\ (super high).

At this point, I treat scalar shifts as a special type of grammatical tone allomorphy, though note that Sande does not adopt this analysis (conceivably this could be treated as a special form of grammatical tone sandhi involving a floating tone expressing aspect). Such data has frequently been cited to support an ‘Item-and-Process’ theory of morphology over an ‘Item-and-Arrangement’ theory (Hockett 1954), as there is no consistent exponent of the grammatical category in the output.

## 3.6 Summary

In this chapter, we summarized several types of dominance effects in grammatical tone (GT) patterns using the terminology such as trigger-sponsor, target-host, and grammatical tone. These GT trigger types are defined below.

- (96) Definitions of GT trigger types in this chapter
- Replacive-dominant GT: the automatic replacement of the underlying tone of within the valuation window of a target-host, revalued with a grammatical tone (whether via a floating tone, spreading from the sponsor, *etc.*)
  - Subtractive-dominant GT: the automatic deletion of the underlying tone of within the valuation window of a target-host, *without* target-host revaluation by a grammatical tone
  - Recessive-non-dominant GT: the non-application of the grammatical tone when a target-host is valued within its valuation window (occurs primarily within privative-culminative systems)
  - Neutral-non-dominant GT: the lack of automatic replacement/deletion of the underlying tone of the target-host or automatic non-application of the grammatical tone

Dominant GT automatically deletes underlying tone of the target-host and can be either replacive or subtractive. In contrast, non-dominant GT does not automatically delete underlying tone of the

target-host, and can be either recessive or neutral. The table below illustrates these patterns schematically.

Trigger-Sponsor	Target-Host	Valued	Unvalued
		/ /	$\begin{matrix} T & T \\   &   \\ \tau & \tau \end{matrix}$
Replacive-Dominant	$\begin{matrix} T^{\textcircled{1}} \\   \\ \tau \end{matrix}$	$\begin{matrix} T & \textcircled{T} \\   & \diagdown \\ \tau & \tau \tau \end{matrix}$	$\begin{matrix} T & \textcircled{T} \\   & \diagdown \\ \tau & \tau \tau \end{matrix}$
Subtractive-Dominant	$\begin{matrix} T \\   \\ \tau \end{matrix}$	$\begin{matrix} T \\   \\ \tau & \tau \tau \end{matrix}$	$\begin{matrix} T \\   \\ \tau & \tau \tau \end{matrix}$
Recessive-Non-dominant	$\begin{matrix} T^{\textcircled{1}} \\   \\ \tau \end{matrix}$	$\begin{matrix} T & T & T \\   &   &   \\ \tau & \tau & \tau \end{matrix}$	$\begin{matrix} T & \textcircled{T} \\   & \diagdown \\ \tau & \tau \tau \end{matrix}$
Neutral-Non-dominant	$\begin{matrix} T^{\textcircled{1}} \\   \\ \tau \end{matrix}$	$\begin{matrix} T & \textcircled{T} & T & T \\   & \diagdown &   &   \\ \tau & & \tau & \tau \end{matrix}$	$\begin{matrix} T & \textcircled{T} \\   & \diagdown \\ \tau & \tau \tau \end{matrix}$

Table 34: Types of GT triggers

We showed that the application of GT is largely insensitive to its phonological context. For example, a grammatical tone consisting of a floating  $\textcircled{1}$  tone is *not* blocked from appearing next to a voiced consonant (a depressor consonant), and results in a marked structure. In general, GT is rarely phonologically optimizing in any consistent sense and the output of its application often results in a more marked structure. We contrasted GT to non-grammatical tonal operations such as phonologically-general H tone spreading, which often are blocked due to markedness.

When more than one trigger is present in a derivation, this follows the outer dominance principle which states that the properties of the outermost trigger are maintained regardless of the content of the target. In other words, a dominant trigger will be dominant regardless of whether it attaches to a root, a non-dominant trigger, or another dominant trigger. We discussed several complications which arise with this principle, including GT indomitability, a type of immutability effect in which structure does not undergo (morpho-)phonological changes as expected, such as the target of a dominant trigger not showing automatic deletion of its underlying tones.

Finally, we established the dominant GT asymmetry: within a multi-morphemic constituent, the dominant trigger is a dependent and the target is a lexical head, or a dependent structurally closer to the lexical head (using the terms dependent and (lexical) head as established in Nichols 1986). This asymmetry captures three main generalizations with dominant GT, shown below, where  $\blacktriangleright$  means ‘dominant over’ (and thus  $\neg\blacktriangleright$  means ‘not dominant over’).

Trigger	Target	Example	cf.	Trigger	Target
a. Affix	▶ Root	<i>Japanese</i> (14)	d.	Root	→▶ Affix
Affix <sub>OUT</sub>	▶ [Affix <sub>IN</sub> -Root] <sub>STEM</sub>	<i>Hausa</i> (37)		Affix <sub>IN</sub>	→▶ Affix <sub>OUT</sub>
b. Modifier	▶ Noun	<i>Kalabari</i> (12)	e.	Noun	→▶ Modifier
Modifier <sub>OUT</sub>	▶ [Modifier <sub>IN</sub> N]	<i>Izon</i> (34)		Modifier <sub>IN</sub>	→▶ Modifier <sub>OUT</sub>
		<i>Jamsay</i> (35)			
c. Object	▶ Verb	<i>Izon</i> (82)	f.	Verb	→▶ Object
		(below)			

Table 35: Patterns captured by the dominant GT asymmetry

In a., affixes can be triggers of dominant GT with a root (the lexical head) and outer affixes which are further away from the root can be triggers of dominant GT to both inner affixes (inner dependents) and the root (the lexical head). Parallel facts hold at the phrase-level shown in b., and also holds between objects (the dependent) and verbs (the lexical head). Note that the reverse patterns in d.-f. are not found supporting earlier work (e.g. Alderete’s ‘strict base mutation’). In Part II developing a theoretical model, I formally capture this through notions of ‘inner’/‘outer’ and ‘cyclicality’ familiar to morphophonological theory.

In contrast to dominant triggers, non-dominant triggers do not show this asymmetry with respect to heads and dependents: roots, modifiers, affixes, verbs, objects, etc. can all trigger non-dominant GT to surrounding morphemes. The contrast between dominant and non-dominant GT triggers is summarize in the table below.

Trigger → Target	GT type	Non-dominant (e.g. simple docking)	Dominant (e.g. replacive)
Grammatical/ Dependent → Lexical head		✓ Yes	✓ Yes
Lexical head → Grammatical/ Dependent		✓ Yes	* No

Table 36: Comparing dominant vs. non-dominant GT

Finally, this survey found no clear phonological asymmetries with respect to linear order for dominant GT. Widely attested are both anticipatory GT where the dominant trigger is to the *right* of the target, as well as perseverative GT where the dominant trigger is the *left* of the target.



**Part II**  
**A theory of grammatical tone**

## **Chapter 4**

### **A model of the syntax/phonology interface: Design goals and design choices**

#### 4.1 The objective of this chapter

Part I of this study developed a typology of grammatical tone (GT), emphasizing those patterns which demonstrated dominance effects. Dominant GT results in the automatic deletion of input tones without reference to phonological markedness, while non-dominant GT does not. For example, Kalabari has dominant GT whereby a demonstrative co-varies with an obligatory LH pattern on the noun which overrides its lexical tone:

- (1) a. / bélé / ‘light’                      b. \ mí bélé \ ‘this light’

Several other major typological generalizations were presented, including what I have called the dominant GT asymmetry:

- (2) **Dominant GT asymmetry:** within a multi-morphemic constituent, the dominant trigger is a dependent, and the target is a lexical head or a dependent structurally closer to the lexical head

This principle generalizes over the triggers and targets of dominant GT, whereby affixes are dominant over roots, modifiers over nouns, and objects over verbs. The reverse is not found.

The objective of this chapter is to present design goals of a model which best captures the typology of grammatical tone and to justify design choices for an interface architecture which serve those goals. In this way, I seek to present a ‘master plan’ of the point of contact between syntax and phonology. This will situate the rest of study which will focus on a novel theoretical treatment of GT.

Any model of GT must capture at least three things: the deletion of a target’s underlying tones, the origin of the trigger’s grammatical tune, and the scope of the grammatical tune in context (i.e. what does it dock to and what does it not dock to). A model can be evaluated in part according to how well it handles the empirical facts associated with these components. This manifests most readily in complex multi-morphemic structures with more than one trigger or target presence, a major component of this part II of the study presented in the chapters which follow.

A major focal point in studying phenomena at the syntax/phonology interface is how ‘modular’ these components are – in other words, are syntax and phonology isolated from one another or are they unifiable within a single grammatical component? I adopt a strictly feed-forward, modular view in which syntax generates structure in a separate morpho-syntactic module ( $\approx$ syntax), and then feeds this generated structure to a separate morpho-phonological module ( $\approx$ phonology). Each of these modules has a separate set of primitives and combinatorics, and distinct ways in how they are restricted.

In modern generative theory, these modules are connected to one another by a process called spell-out. This study understands spell-out as a set of operations which ‘translate’ the hierarchical, syntactic structure into an object which is readable by a morpho-phonological grammar, ultimately fed to an articulatory motor plan as an end point. The most tangible effect of spell-out is actuating phonological structure, resulting in the form/meaning pairings deeply engrained in linguistic inquiry. A major focus of this chapter will be articulating the substance of spell-out. What operations are involved in the translation between these modules, and what operations are before and after them? How isomorphic is the structure between (morpho-)syntax and (morpho-)phonology, and what are the restrictions on non-isomorphism?

Many empirical generalizations involving grammatical tone show evidence for cyclicity, which we can understand as multiple input-output mappings within a linguistic derivation whereby the output of one ‘cycle’ is the input to the next one. Cyclicity in the morpho-syntactic

module represents the null hypothesis in the Minimalist Program (Chomsky 1995; Epstein 1999; Richards 2011:175-182; see Uriagereka 2011 for an overview of the ‘cycle’ in generative grammar).<sup>1</sup> Equally, there is substantial evidence for the cycle within the morpho-phonological module as well, e.g. as detailed in Inkelas (2014:190ff.).<sup>2</sup> An inside-out characterization of cyclicity is the most-common position across many subfields, frameworks, modules, and phenomena (see Carstairs 1987; Bobaljik 2000; Carstairs-McCarthy 2001; Embick 2010:42; Bermúdez-Otero 2011). I argue that grammatical tone provides supporting evidence for this type of cyclicity, showing ‘obligatory inheritance’ of a previous cycle and the need for notions such as ‘inner’ and ‘outer’ in relating morphemes.

I forward a common hypothesis in syntax/phonology interface modeling that c-command plays a central role in determining phonological patterns. This has been defended for grammatical tone recently by McPherson (2014) and McPherson & Heath (2016), which I claim to be essentially correct. However, I operationalize c-command via an indirect reference model in which phonology does not have direct access to syntactic information. The central relevant operation converting syntactic hierarchical structure to morpho-phonological structure (where the effects of c-command are seen) is what I call hierarchy exchange.

This operation defines the cycles of phonological constraints, which I couch within Cophonology Theory (CPT - Orgun 1996; Anttila 1997, 2002; Inkelas 1998; Orgun & Inkelas 2002; Inkelas & Zoll 2005, 2007; a.o.). Under CPT, morphological constructions and lexical classes are associated with distinct, fully general grammars, which in the current OT era is couched as having distinct constraint rankings or weightings. For example, to resolve vowel hiatus one construction may trigger epenthesis while another deletion, as dictated by the constructions’ associated sub-grammar. A noted advantage of CPT is its ability to integrate morphologically-conditioned phonology in the same theory as non-concatenative/process morphology (Inkelas 2014:80), such that distinguishing the two is not necessary. Grammatical tone is a representative example of a phenomenon straddling this indeterminate boundary.

A key advantage of Cophonology Theory is that it has intrinsic scope by virtue of being a cyclic model. Morphemes and constructions occur in nested, hierarchical structures and the cophonologies associated with them apply cyclically in an inside-out fashion as one moves up the morphological tree. This does not need to be stipulated, which would be necessary if we assumed other models. For example, empirically faulty predictions are made if cyclicity is not incorporated, as in Indexed Constraint Theory (Pater 2000, 2007, a.o.). The main distinction is that Indexed Constraint Theory indexes phonological constraints to individual *morphemes*, while Cophonology theory ‘indexes’ such constraints to entire *sub-constituents*. It is a fundamental aspect of grammatical tone that it can affect constituents and not solely individual morphemes in

---

<sup>1</sup> Richards (2011:175-176) discusses cyclicity in minimalism and Chomsky’s ‘extension condition’:

*“The cycle is another concept inherited from pre-minimalist approaches to syntax; it requires that operations which affect lower parts of the tree occur earlier in the derivation than operations which affect higher parts of the tree. ...*

*Chomsky (1993) noted that a version of the cycle could come from a condition on Merge operations which required the Merge operation to ‘extend the tree’, creating a new node which dominates a previously undominated node.”*

<sup>2</sup> I am using a broader definition of cyclicity which collapses what Inkelas (2014:190) distinguishes as ‘true cyclicity’ in morphophonology in which “the very same phonological alternation applies (or the very same constraint is imposed) at every step of the morphology” versus ‘layering’ in which “*some* phonological alternations apply (or *some* constraints are enforced) at every step of the morphology, even if they are not the same ones” (italics hers). We can think of true cyclicity as a rarer subtype of cyclicity generally.

question. In what follows, I expand on Inkelas' (1998) conception of cophonologies in particular, where dominant GT is analyzed as applying cyclically.

The model I present implements Cophonology Theory within Distributed Morphology (Halle & Marantz 1993). Classic CPT assumes a Lexicalist model where the application of cophonologies is part of word-building. However, as shown in Part I establishing a typology, grammatical tone is a robust phenomenon below and above the word with largescale parallels. As Distributed Morphology (DM) is a non-Lexicalist model in which words and phrases are built up using the same architecture, it is well-suited to handle this aspect of grammatical tone. Several parts of this DM implementation will be 'non-standard', and will be justified as they come up. In general, I adopt what I term 'Optimality-Theoretic Distributed Morphology' (OT-DM), following work in Trommer (2001a, 2001b, 2002), Dawson (2017), Foley (to appear), and Rolle (accepted).

As this is largely a theoretical study, the question remains: why study tone? I will show that grammatical tone provides us a unique lens to study these issues of syntax/phonology modularity, cyclicity, the scope of a phonological operation, among many others. Tone has numerous properties which other phonology does not, both in quantity and quality (detailed in Hyman 2011) and in its computational properties (Jardine 2014). The use of tone to express grammatical meaning inherits this distinct set of properties, and more.

## 4.2 The patterns to capture: Dominance effects in GT

**Grammatical tone (GT)** is defined as the following:

- (3) **Grammatical tone (GT):** a tonological operation which is not general across the phonological grammar, and is restricted to the context of a specific morpheme or construction, or a natural class of morphemes or constructions<sup>3</sup>

This includes grammatically conditioned tonological operations such as tone addition, deletion, replacement, shifting, assimilation, dissimilation, *etc.* The focus of this part II will be a theory of dominance effects in GT, whose components are repeated below:

- (4) **GT components in dominance effects**
- a. **Grammatical tune:** the unique tone sequence which covaries with the grammatical tone construction
  - b. **Sponsor:** the morpheme (or natural class of morphemes) which covaries with the grammatical tune
  - c. **Trigger:** the morpheme or construction which licenses the tonological operation
  - d. **Host:** the morpheme or morphemes on which the grammatical tune appears
  - e. **Target:** the morpheme or morphemes which is the intended recipient of a tonological operation
  - f. **Valuation window:** the portion of the target-host which is evaluated with respect to whether its TBUs are valued or unvalued; this can be global (coextensive with the target-host) or local (not coextensive)

When the trigger and sponsor are the same or if they cannot be reasonably distinguished, I call it the trigger-sponsor. The same holds for using the term target-host.

---

<sup>3</sup> In what follows, I use 'morpheme' in the neutral sense, not in the DM-specific sense.

Using these components, we can distinguish two main types of dominance effects, split into two sub-types. One is **dominant GT**, split into **replacive-dominant** and **subtractive-dominant GT**; the other is **non-dominant GT**, split into **recessive** and **neutral GT**. [Note that the term ‘dominance’ here is not syntactic dominance, to which it is unrelated.]

Replacive-dominant GT was defined as the ‘the automatic deletion of the underlying tone within the valuation window of a target-host, revalued with a grammatical tune’, whether via a floating tone, spreading from the sponsor, *etc.* An example of replacive-dominant GT from Kalabari [i.j.n] is below. Note that the superscripted and circled tones are floating low and floating high.

(5)	Replacive-dominant GT	/ mí <sup>ⓁⓂ</sup> / ‘this’ (neut.)	/ mí <sup>↑</sup> ná <sup>ⓁⓂ</sup> / ‘these’
		[H LH]	[H <sup>↑</sup> H LH]
a.	HH / ná má / ‘meat’	\ mí <b>námá</b> \	\ mí <sup>↑</sup> ná <b>námá</b> \
b.	LL / pùlò / ‘oil’	\ mí <b>pùló</b> \	\ mí <sup>↑</sup> ná <b>pùló</b> \
c.	HL / bélé / ‘light’	\ mí <b>bélé</b> \	\ mí <sup>↑</sup> ná <b>bélé</b> \
d.	LH / gàrí / ‘garri (food)’	\ mí <b>gàrí</b> \	\ mí <sup>↑</sup> ná <b>gàrí</b> \
e.	H <sup>↑</sup> H / bá <sup>↑</sup> rá / ‘hand’	\ mí <b>bàrá</b> \	\ mí <sup>↑</sup> ná <b>bàrá</b> \

[Kalabari - Harry & Hyman 2014:6]

Here, the underlying tones of the noun (the target-host) are replaced by a LH melody (the grammatical tune) in the context of a demonstrative (the trigger-sponsor). The components of this grammatical tone sequence are provided in the diagram below.

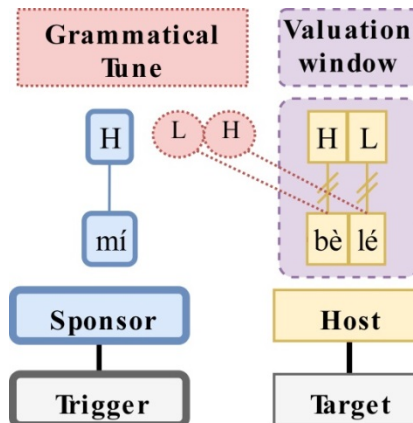

Figure 1: Full components of grammatical tone

In most cases the sponsor and the trigger will be the same, and the host and target will be the same. In these cases, we refer to them as trigger-sponsor and target-host, respectively.

In contrast, subtractive-dominant was defined as ‘the automatic deletion of the underlying tone within the valuation window of a target-host, without target-host revaluation by a grammatical tune’. For example in (6) from Japanese, the underlying tone is deleted from the target in the context of *-teki* ‘-like’, but no new tones are assigned.

(6) Subtractive-dominant GT

- |    |                    |   |                       |  |                                |
|----|--------------------|---|-----------------------|--|--------------------------------|
|    | /...H.../          |   | \...Ø...\<br>→        |  |                                |
| a. | / anáta + teki /   | → | \ anata-teki \<br>→   |  | ‘in your opinion’ (colloquial) |
| b. | / rónri + teki /   | → | \ ronri-teki \<br>→   |  | ‘logical’                      |
| c. | / búngaku + teki / | → | \ bungaku-teki \<br>→ |  | ‘literature-like’              |

[Japanese – Kawahara 2015:470]

One non-dominant GT is recessive GT, defined as ‘the non-application of the grammatical tune when a target-host is valued within its valuation window’, and occurs primarily within privative-culminative systems (e.g. H vs. Ø, one H per word). Recessive GT applies if the target has no underlying tone (it is unvalued), and does not apply if the target has underlying tone (it is valued). A Japanese example is below.

(7) Recessive-non-dominant GT

- |    |            |                       |   |                      |                                |
|----|------------|-----------------------|---|----------------------|--------------------------------|
| a. | Unvalued   |                       |   |                      |                                |
|    | / ono      | + - <sup>Ⓣ</sup> si / | → | \ onó-si \<br>→      | ‘Mr. Ono’                      |
|    | / yosida   | + - <sup>Ⓣ</sup> si / | → | \ yosidá-si \<br>→   | ‘Mr. Yoshida’                  |
|    | / edogawa  | + - <sup>Ⓣ</sup> si / | → | \ edogawá-si \<br>→  | ‘Mr. Edogawa’                  |
| b. | Valued     |                       |   |                      |                                |
|    | / úra      | + - <sup>Ⓣ</sup> si / | → | \ úra-si \<br>→      | ‘Mr. Ura’ (*urá-si)            |
|    | / múraki   | + - <sup>Ⓣ</sup> si / | → | \ múraki-si \<br>→   | ‘Mr. Muraki’ (*murakí-si)      |
|    | / nisímura | + - <sup>Ⓣ</sup> si / | → | \ nisímura-si \<br>→ | ‘Mr. Nishimura’ (*nisimurá-si) |

[Japanese - Kawahara 2015:468]

Here, the suffix *-si* ‘Mr.’ assigns a high tone to the final TBU of the stem (the target) if it is unvalued, but it does not assign this high tone if the stem is valued with underlying tone (cf. ungrammatical examples in (7)b. at the right).

Finally, another type of non-dominant GT is neutral GT defined negatively as ‘the lack of automatic replacement/deletion of the underlying tone of the target-host or automatic non-application of the grammatical tune’. This applies regardless of the value of the target (unlike recessive GT), and does not override target tones (unlike dominant GT). For example in (8) from Hausa, the referential suffix *-n* (approximately meaning ‘the’) assigns a low tone to the stem target. This does not (automatically) delete underlying tone but rather co-occurs with it, e.g. in (a), the final H in underlying /LH/ in /jààkíi/ becomes falling tone in [jààkîn].

(8) Neutral-non-dominant GT

- |    |            |                     |   |                     |                              |
|----|------------|---------------------|---|---------------------|------------------------------|
| a. | /jààkíi    | + - <sup>Ⓛ</sup> n/ | → | \ jààkíin \<br>→    | [jààkîn] ‘the donkey’        |
| b. | /sààtáccéé | + - <sup>Ⓛ</sup> n/ | → | \ sààtáccéèn \<br>→ | [sààtáccên] ‘the stolen one’ |
| c. | /zóómààyéé | + - <sup>Ⓛ</sup> n/ | → | \ zóómààyéèn \<br>→ | [zóómààyên] ‘the hares’      |
| d. | /hársúnàà  | + - <sup>Ⓛ</sup> n/ | → | \ hársúnààn \<br>→  | [hársúnàn] ‘the languages’   |

[Hausa - Newman 1986:257]

### 4.3 Desiderata for a model of GT

There are several desiderata for a model of grammatical tone. At the very least, a model needs to be able to adequately account for three issues: origin, erasure, and scope. I cast our discussion of these issues as a series of ‘problems’ (inspired by Trommer 2011), which can be understood as the necessary challenges any model of GT must address.

(9) Problems a model of GT must address

- a. **The origin problem** – how is the grammatical tune introduced? where is its origin?

- b. **The erasure problem** – how are underlying tones of the target deleted (in other words, go unrealized)?
- c. **The scope problem** – how is the scope of the grammatical tune established? how is the target-host determined?

Let us illustrate these problems with the following example from Kalabari.

(10)    *námá* +    *wá<sup>↑</sup>rí* +    *améè*    →    *námá* *wári* *àméè*  
 animal        house        PLURAL                    ‘the animal(?) houses’  
 [N<sub>1</sub>]            [N<sub>2</sub>]            [PL]

[Kalabari – Harry & Hyman 2014:664]

This example consists of the sequence [N<sub>1</sub> N<sub>2</sub> PL]. These morphemes are shown on the left with their underlying tones and meaning. On the right is the meaning in context and surface pattern. In Kalabari, [N<sub>1</sub> N<sub>2</sub>] sequences express both possession and compounds, hence the ambiguity in the translation. The plural marker refers to the number of houses (not the number of animals). Important for our purposes, the tone on N<sub>2</sub> changes from underlying /H<sup>↑</sup>H/ to a surface pattern [HL], and this is not due to regular tonology. In [N<sub>1</sub> N<sub>2</sub>] sequences, the second noun’s tones are automatically replaced with a [HL] pattern, which we can understand as the grammatical tune.

We can isolate parts of this example and identify where the problems (i.e. challenges) are for any GT model, as shown below. For our purposes, the docked grammatical tune is indicated as circled tonemes  $\textcircled{\text{H}}\textcircled{\text{L}}$ .

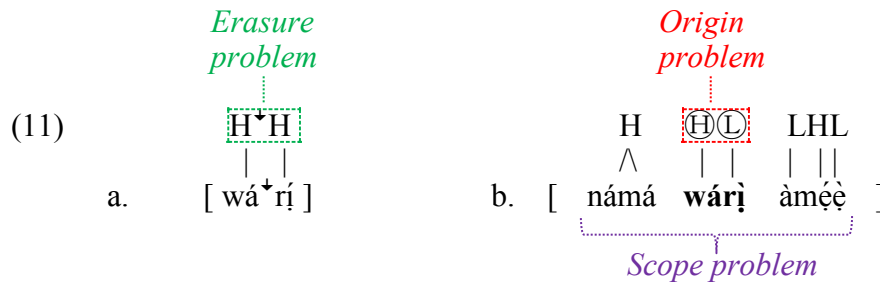

First, (11)a. shows the pronunciation of /wá<sup>↑</sup>rí/ ‘house’ in isolation with its underlying tones. This represents the **erasure problem**: by what mechanism are these underlying tones deleted in the context to the right in b.? How do they go unrealized? For example, should we attribute underlying tone erasure to a special type of markedness or faithfulness constraint? Or is it deleted due to competition with the grammatical tune? The erasure problem has the premise that there is actual erasure in an input-to-output mapping: is this truly the case or is this only apparent (i.e. no actual deletion)?

Second, (11)b. shows the form in context where it bears the  $\textcircled{\text{H}}\textcircled{\text{L}}$  grammatical tune. This represents the **origin problem**. Logically, the  $\textcircled{\text{H}}\textcircled{\text{L}}$  grammatical tune could be introduced as (i) an inherent property of the underlying representation of N<sub>1</sub> /námá/ ‘meat’, (ii) a floating tonal morpheme which expresses possession/compounding and is independent of N<sub>1</sub>, (iii) an inherent property of the target itself constituting an allomorph /wári/ used in this context, (iv) a product of a morphophonological constraint or process without any independent existence, and many other conceptions. If this is a floating tone sequence, is it mapped to the target via general toneme to TBU association conventions, or some other algorithm altogether? Note that in some theoretical treatments of GT, the erasure problem and the origin problem are collapsed as a single override



(McPherson 2014, McPherson & Heath 2016). Should we treat GT as two steps (first deletion, then assignment), or as a one-step melodic overwriting?

Third is the **scope problem**: why does the  $\textcircled{H}\textcircled{L}$  grammatical tune fall on  $N_2$ , and not on the other morphemes  $N_1$  and the plural marker? Is this determined by linear precedence relations or does it refer to hierarchical structure? Is the target always ‘local’ in some explicit sense, or can it ever be non-local? And how do any scope restrictions inform how the syntax/phonology interface should be modelled in general?

In chapters 5 and 6, I compare and contrast the model that I present to those already in the literature, showing the modeling choices designed to handle these problems. These chapters will support my model as both empirically and conceptually superior.

#### 4.4 The design of the syntax/phonology interface

This section lays out the design of the syntax/phonology interface influenced by the need for GT to refer to syntactic structure in some capacity. I emphasize three distinct components of this interface: the **morpho-syntactic module**, the **morpho-phonological module**, and **spell-out** which relates the two modules. Spell-out itself is not a module, existing in what Scheer (2011:320) calls ‘modular no man’s land’. A simple schematic illustrates the interface in Figure 2 below. [Recall that backslashes \ \ indicate the output in an input-output mapping; square brackets [ ] are reserved strictly for surface forms.]

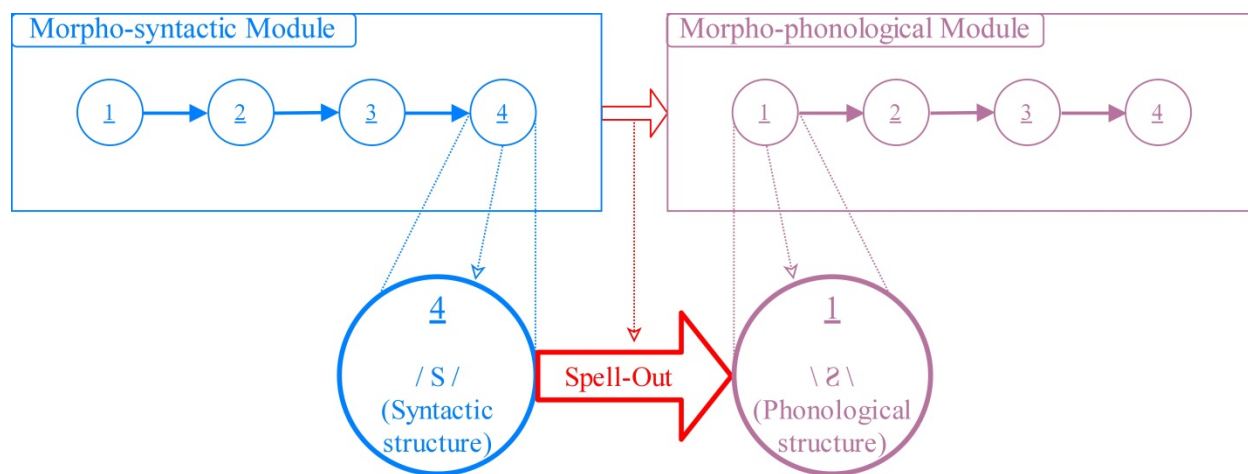

Figure 2: Morpho-syntactic module maps to morpho-phonological module via spell-out

This model illustrates the morpho-syntactic module (in blue), whose primitives are morpho-syntactic feature bundles subject to syntactic operations such as Merge. This is mapped to the morpho-phonological module (in purple), whose primitives are phonological strings (exponed via vocabulary insertion) and subject to a phonological grammar. They are connected via ‘spell-out’ (in red). The morpho-syntactic representation is mapped to a morpho-phonological representation but not vice versa, and as such follows standard assumptions of phonology-free syntax (Zwicky & Pullum 1986) and the ‘Y-Model’ of grammar common to Distributed Morphology and much Minimalist work in the syntax/morphology interface (e.g. Bobaljik 2017).

Within a module, the relevant operations apply cyclically, a concept we defined above as multiple input-output mappings whereby the output of one ‘cycle’ is the input to the next cycle and subject to the same kind of operations. This is indicated in Figure 2 by the connected circles numbered 1-4: each circle is a cycle and its output is fed to the next cycle. I refer to this as **intra-module cyclicity**.

Note, however, that *between* these modules spell-out transfers structure from syntax to phonology only once. The final syntactic structure before spell-out (circle 4) is translated via spell-out into a phonological structure which is the input to this module (circle 1). This is zoomed out in the figure above for clarity. I call the final syntactic structure the **syntactic image** /S/ and the initial phonological structure the **phonological image** \2\, and the mapping between them /S/→\2\ (more on this below). Thus, unlike within modules spell-out is non-cyclic in that it involves a single input-to-output mapping where all operations apply in parallel, contra the oft-cited cyclic models of spell-out (e.g. Bobaljik 2000; McCarthy 2008; Wolf 2008; Kastner 2018; a.o.). This does not entail that spell-out cannot happen several times, just that when it does it is a single input-to-output mapping. Ultimately, I take no position as to whether spell-out happens multiple times within a derivation (as assumed in a phase-based model), a point I will return to below, and several other times in the rest of this study.

#### 4.4.1 Pre-spell-out: The morpho-syntactic module

I couch my model within general assumptions of generative syntax, primarily following the Minimalist Program and its predecessor X-bar theory (Chomsky 1995; Epstein & Hornstein 1999; Adger 2003; Bošković & Lasnik 2007; a.o.). Above all, however, I assume the general working principles of Distributed Morphology (Halle & Marantz 1993), whose main focus is the syntax/morphology interface. As our starting point, let us examine the oft-cited ‘Y-model of grammar’ (or ‘T-model’), as shown in Figure 3 (variants of this model are found widely across generative inquiry, including Chomsky 1981, Freidin & Lasnik 2011:13, Bobaljik 2017, a.o.).

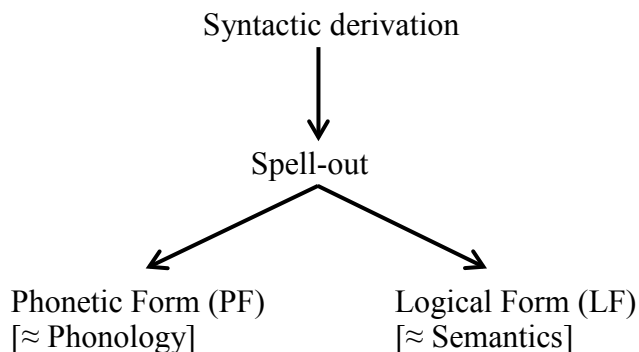

Figure 3: Y-model of grammar

Under the Y-model, structure is built first within a syntactic derivation via a central syntactic operation **Merge**. The exact mechanics of this operation are not pertinent to this study, simply the resulting structure. At some point, the syntactic structure is ‘spelled-out’ and sent to two separate branches. One branch is the phonetic form (PF), which for our purposes we can take to be (morpho-)phonology. Another branch is logical form (LF) which involves semantic relations entirely outside of our discussion of GT, and not discussed further.

Following modular conceptions of grammar (e.g. Fodor 1983, Levelt 1989), I call the location where syntactic derivation takes place the morpho-syntactic module, equivalent to the ‘syntactic derivation’ portion at the top of Figure 3 above. An articulated model of the morpho-syntactic module is in Figure 4 below. Note that I illustrate this module for expository purposes only, not to imply that the individual cycles which are given are the exact correct ones in phrase building.

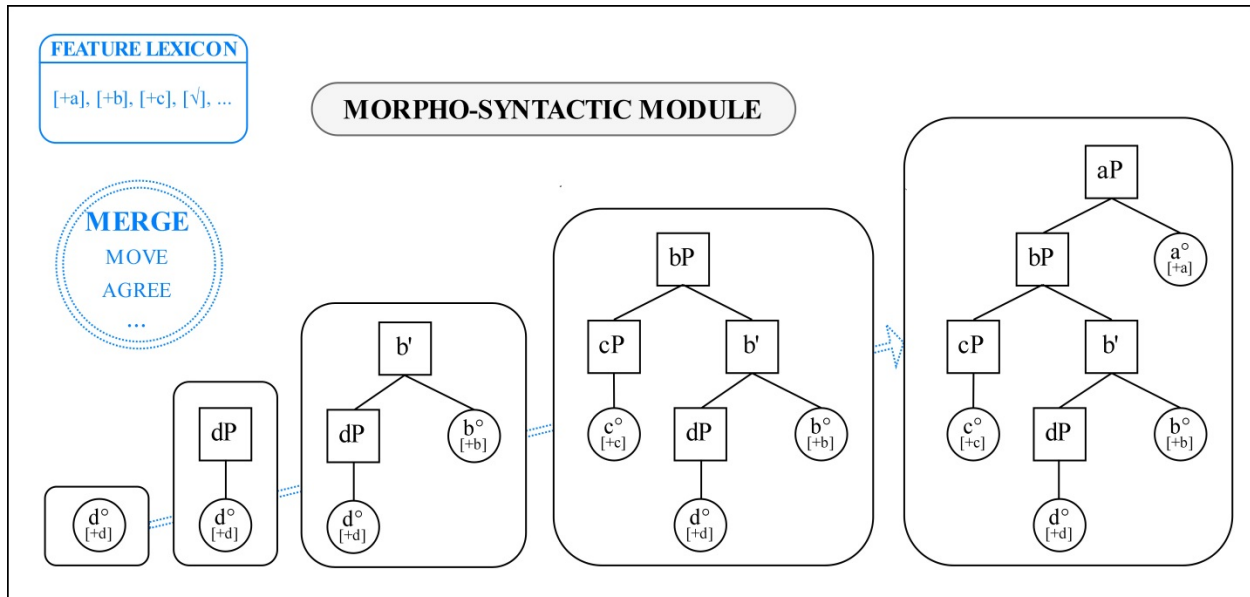

Figure 4: Morpho-syntactic module with cyclic application of syntactic operations

The morpho-syntactic module can be split up into two basic components: a set of primitives (paradigmatic oppositions) and combinatory principles concatenating primitives (syntagmatic relations). The primitives in the morpho-syntactic module are taken from the **feature lexicon** (in blue at top left), equivalent to the *Narrow Lexicon* in Marantz (1997:204), *List A* in Harley & Noyer (1999), *List I* in Harley (2014), and the *List of Syntactic Atoms* in Bobaljik (2017). The feature lexicon consists of bundles of **morphosyntactic features** (‘SynSem features’ in Embick 2015:34).

The syntactic structure is built up cyclically via the central syntactic operation Merge (indicated in the circle below the feature lexicon). This proceeds bottom-up/inside-out (Chomsky 1995, Epstein 1999:325). Syntactic operations are provided at the left side of this figure, and the blue arrow behind the set of syntactic trees represents cyclic application of these operations with the addition of each feature bundle from the feature lexicon. Each bundle of morphosyntactic features constitutes a ‘(terminal) head’, represented as  $X^\circ$  (sometimes just  $X$ ). Following Merge, one morpheme projects its category to label the higher node (Chomsky 1995:243-246, and much subsequent work).

One premise of the minimalist program requires further discussion: classic X-bar schema vs. bare phrase structure (Chomsky 1995:241-249). Under X-bar theory all phrases have a uniform structure and syntactic arguments appear in well-defined positions relative to the head. A standard X-bar schema is given in Figure 5 below (adapted from Adger 2003:114).

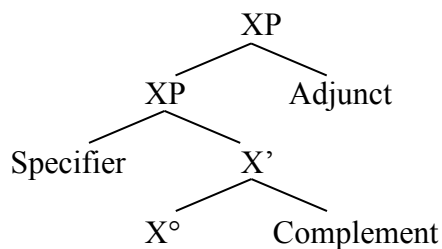

Figure 5: X-bar schema

Relevant syntactic positions are the **complement**, **specifier**, and **adjunct**, defined below. Each of these positions can constitute its own XP.

- (12) Syntactic positions
- a. Complement - sister to  $X^\circ$  (the head)
  - b. Specifier - sister to  $X'(\sim\bar{X})$  (an intermediate node)
  - c. Adjunct - sister to XP (the highest level of the projection)

In our morpho-syntactic module in Figure 4, the terminal node  $b^\circ$  has a complement dP and a specifier cP; its maximal projection bP itself is the complement to the head  $a^\circ$ .

In contrast to X-bar theory, bare phrase structure permits branching only when two objects have merged, thus ruling out unary branching where  $X'$  branches only to  $X^\circ$ . This is summed up by Epstein (1999):

*“Assuming bare phrase structure (Chomsky 1994), no category is dominated by a nonbranching node. In other words, free projection (as in Chomsky 1993) is eliminated: structure building (Merge and Move) consists of pairing, hence invariably generates binary branching.”*

[Epstein 1999:330]

In this way, branching only happens under Merge.

This study is in line with bare phrase structure except for the following: I assume that all  $X^\circ$  heads must project an XP and thus minimally consist of two nodes.

- (13) XP  
 |  
 $X^\circ$

This structure occurs whether or not  $X^\circ$  merges with any object. I assume this structure in order to adopt a more precise definition of c-command which is critical to the spell-out operation ‘hierarchy exchange’, to be discussed in the next subsection. It may be possible that this entire study be made compatible with bare phrase structure if certain modifications are made, but I do not attempt this here.

Let us now examine how this conception of the morpho-syntactic module integrates with the tenets of Distributed Morphology. Within the feature lexicon (top left of Figure 4), a morphosyntactic feature bundle may have one feature or multiple features. These features come in two types. The first are **roots**, open lexical meanings such as  $\sqrt{\text{CAT}}$ ,  $\sqrt{\text{OX}}$ ,  $\sqrt{\text{SIT}}$ , etc. (Embick 2015:7). Roots are the most deeply embedded features of a phrase. They combine with the second type **functional morphemes** which are pure morphosyntactic features – e.g. category-defining heads [ $n$ ] for nouns, [ $v$ ] for verbs – as well as familiar grammatical meanings like [PAST], [PERFECTIVE], [PLURAL], [PERSON], etc. The result of concatenating these feature bundles via Merge is familiar hierarchical structures (trees).

The figure below exemplifies this with a real data point, the English sequence <cats> (tree from Embick 2015:10). Although <cats> is a complex word, it is subject to the same syntactic structure as phrases. It is a core tenet of DM that both word structure and phrase structure are built up in this morpho-syntactic module (being a strongly non-Lexicalist model).

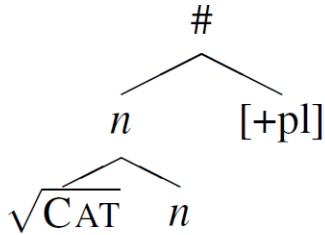

Figure 6: Structure of the sequence <cats> ‘a plurality of small domesticated carnivorous mammals with soft fur, short snouts, and retractile claws’

Here, the root [ $\sqrt{\text{CAT}}$ ] merges with a categorizing functional morpheme  $n$ . This merged sequence [ $\sqrt{\text{CAT}}$ ] $n$  is then merged with a functional morpheme [+PL] indicating plurality in the next morphosyntactic ‘cycle’, which projects a # label to the higher node (standing for number). Updating the diagram of <cats> from Figure 6 to the schema adopted here in which all heads project an XP would look as below.

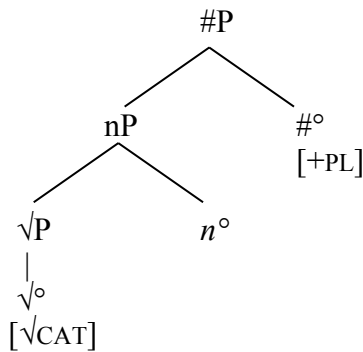

Figure 7: Adapted structure of <cats>

At a point in the syntactic derivation, the syntactic representation is ‘spelled-out’ and transferred to the other two modules, PF (phonetic form) and LF (logical form) as in Figure 3 above. This juncture is called spell-out. By assuming a feed-forward modular architecture, the morpho-syntactic module (its primitives and operations) cannot access the PF or LF branches until it undergoes spell-out (the principle of phonology-free syntax - Zwicky & Pullum 1986). This therefore predicts that syntax will not be affected by any phonological information (no look-ahead).<sup>4</sup>

The next section will discuss the substance of spell-out. Before we turn to that discussion, we should note that an extensive literature has developed which examines ‘triggers’ of spell-out most prominently ‘phase theory’ (Chomsky 2001, 2008, 2012; Bruening 2014; Sande & Jenks 2017). Within phase theory, specific nodes (typically  $C^\circ$ ,  $D^\circ$ ,  $v^\circ$ ) trigger spell-out of their complement, a syntactic structure referred to as the ‘phase’. In this study, I will not examine the triggers of spell-out, and consequently do not entertain phasehood. We will be looking at the internal structure of spell-out and its consequences, not what initiates it.

Relatedly, I will not examine how many phases there are within a derivation, in other words how many applications of spell-out there are. We stated above that between modules, spell-out is

<sup>4</sup> Recent work has challenged this assumption, e.g. Richards’ (2016) *Contiguity Theory*, and Shih & Zuraw (2017). Addressing these challenges fall outside of our scope here.

non-cyclic. I take this to mean that when spell-out is initiated, it maps the syntactic image to a phonological image in a single, fully parallel input-output mapping. This is a distinct issue from what is often addressed in phase theory, namely multiple applications of spell-out. Note that my model is not incompatible with phase theory, and integrating the two should be investigated. Phases are brought up again briefly in chapter 6 discussing phase-based indomitability (McPherson 2014).<sup>5</sup>

#### 4.4.2 The substance of spell-out: Module-to-module mapping

As stated, a core analytic move of DM is decomposing traditional ‘morphemes’ and ‘morphology’ into sets of primitives and operations which apply at various stages across the linguistic derivation (hence the term ‘distributed’). Several DM operations take place at spell-out, and as such can be understood as the ‘substance’ of spell-out.

To begin, at its core spell-out is module-to-module mapping. This was shown above repeated in the figure below.

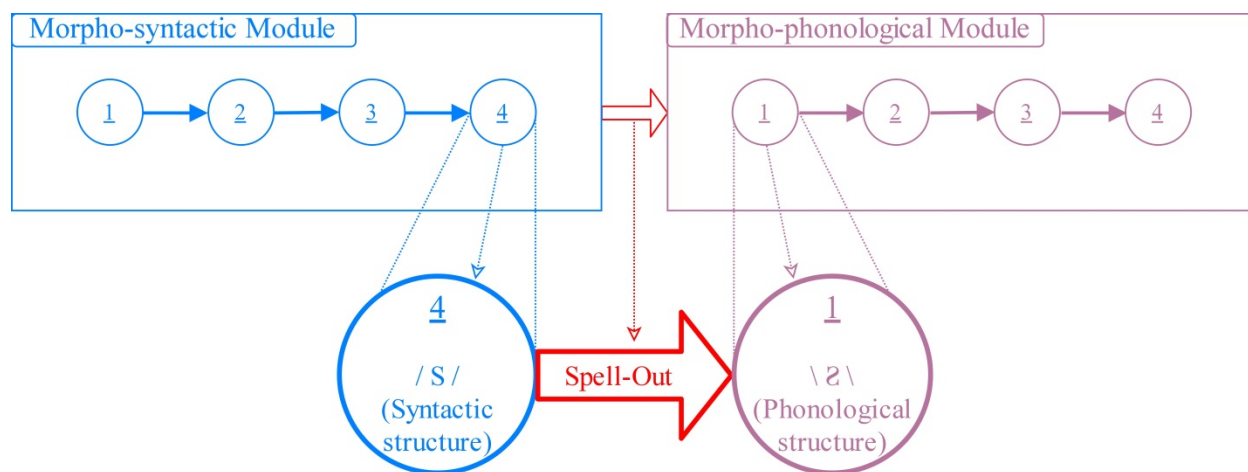

Figure 8: Morpho-syntactic module maps to morpho-phonological module via spell-out

Crucially, the final syntactic structure before spell-out (circle 4) is translated via spell-out into a phonological structure which is readable by morpho-phonological operations/constraints, and is the input to this module (circle 1). We can further articulate this structure as Figure 9 below:

<sup>5</sup> One aspect of phases which I explicitly argue against is the idea that the scope of morpho-phonological operations (such as grammatical tone) is the phase. This is argued for explicitly in Sande & Jenks (2017) who argue that “segmental content, prosodic requirements, and the cophonologies within a phase...are inherited by the phase head, and together scope over the entire phase domain”. They call their model ‘Cophonologies by Phase’ (CBP), defined as the following principle: “cophonologies take scope over the phase in which they are interpreted”. This principle is at odds with cophonology-scope as is established in section 4.4.6 below, and laid out in full in chapter 6.

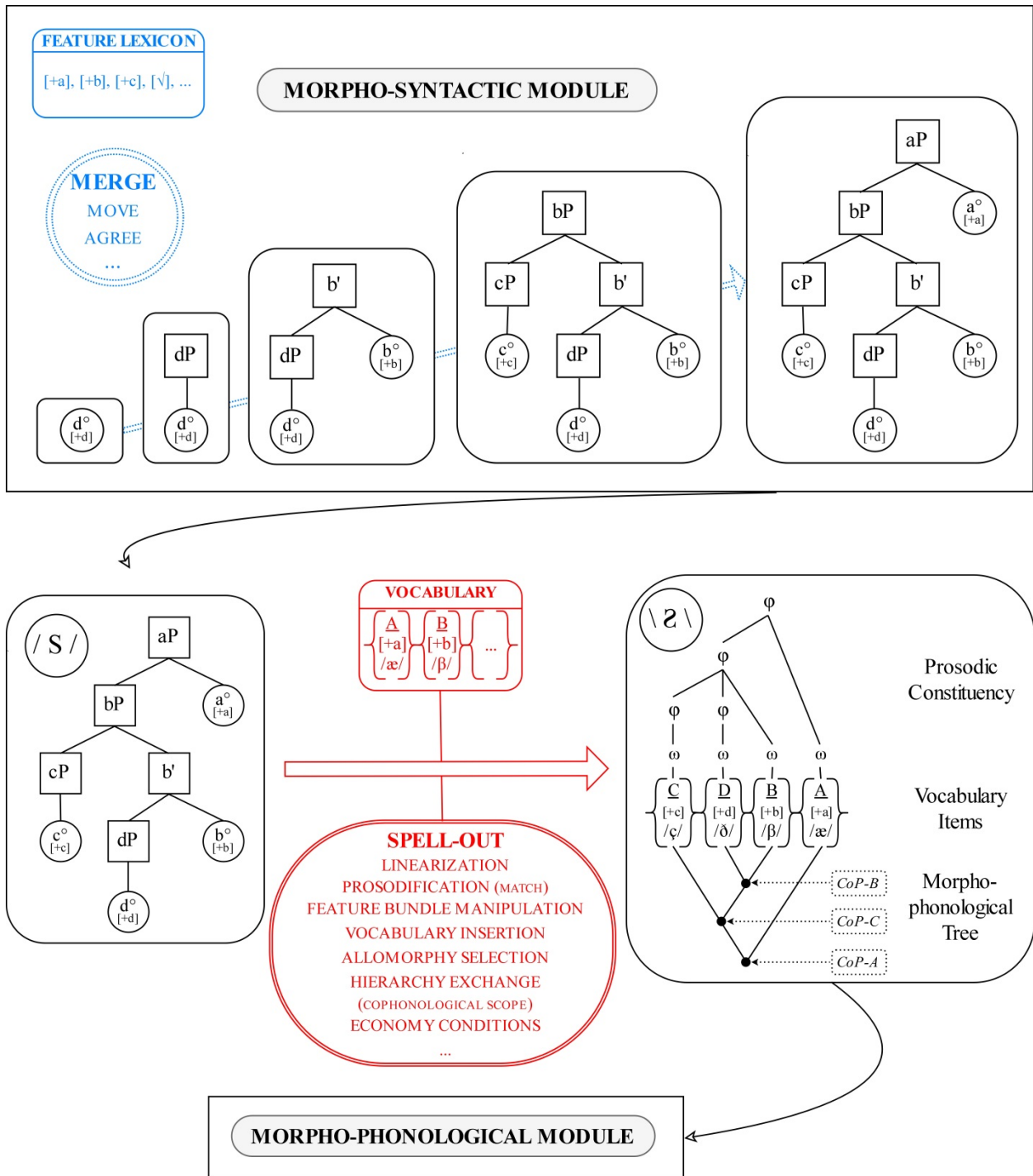

Figure 9: Mapping of syntactic image / S / (the input) to a phonological image \mathcal{Z} \ (the output)

The morpho-syntactic module is repeated at the top. This consists of heads  $X^\circ$ , each consisting of bundles of morphosyntactic features ( $[+a]$ ,  $[+b]$ ,  $[+c]$ , and  $[+d]$ ) and part of maximal XP projections (aP, bP, cP, and dP).

The final syntactic structure is the input of spell-out (indicated by the first black arrow). I referred to this as the syntactic image and abbreviate it as /S/ (and equivalent to the zoomed-in circle 4 in Figure 8). Spell-out maps this syntactic image input to what I referred to as the

phonological image, abbreviated as  $\setminus\mathcal{Z}$  (and equivalent to the zoomed-in circle 1 in Figure 8). I therefore define ‘spell-out’ as the following:

[Def 1] **Spell-out**: a mapping from a syntactic image input /S/ (taken from the morpho-syntactic module) to a phonological image output  $\setminus\mathcal{Z}$  (sent to the morpho-phonological module)

Spell-out as presented in Figure 9 contains several operations. From the DM literature and interface literature generally, these include at the very least the following operations: **vocabulary insertion**, **linearization**, **prosodification**, and **hierarchy exchange** (I innovate this final operation to be defined immediately below). As a whole, spell-out can be conceptualized as the **actuation of phonology** in a derivation.

(14)	Spell-out operation	Provides
a.	Vocabulary insertion	Phonological material
b.	Linearization	Phonological precedence
c.	Prosodification	Phonological constituency
d.	Hierarchy exchange	Phonological operation scope

Each of these operations provides a separate component necessary for a well-formed object at the morpho-phonological module. Vocabulary insertion provides phonological material (within a vocabulary item), the strings of phonemes, tonemes, *etc.* associated with a particular meaning. Vocabulary items inserted from vocabulary insertion are the curly bracketed objects { } within the phonological image  $\setminus\mathcal{Z}$  in Figure 9 above, each with a unique label. Vocabulary insertion plays a major role in determining the behavior of the grammatical tune, and I will return to it below. For each vocabulary item, the operation linearization establishes linear precedence relations, also seen in the figure above (the order of { } objects in a row).<sup>6</sup>

Prosodification involves establishing prosodic constituency, e.g. the familiar prosodic hierarchy with categories  $\sigma$ ,  $\omega$ ,  $\phi$ , etc. (Selkirk 1984). Research on prosodification has seen a surge in recent years with the advent of Match Theory (Selkirk 2009, 2011; a.o.). Under this theory, a constraint MATCH CLAUSE matches syntactic clauses with intonational phrases ( $\iota$ ), MATCH PHRASE matches XP’s with phonological phrases ( $\phi$ ), and MATCH WORD matches X<sup>o</sup>’s with phonological words ( $\omega$ ). This matching is reflected in the phonological image  $\setminus\mathcal{Z}$  above, which is labeled ‘prosodic constituency’.<sup>7</sup>

It may come as a surprise that prosodic constituency is largely orthogonal to grammatical tone patterns, and as such I do not devote much time to it in this study. Simply put, the distribution of grammatical tone for the most part does not make reference to prosodic

<sup>6</sup> A separate question is whether precedence is *only* established here at spell-out, or whether there are precedence relations between objects in the morpho-syntactic module which spell-out simply manipulates. For one view supporting precedence in syntax, see Bruening (2014). I take no position here.

<sup>7</sup> It is a tacit assumption of Match Theory that prosodic structure is not established cyclically (Selkirk 2011, Elfner 2012, Clemens 2014). For example, throughout Clemens (2014), the input is a full syntactic clause and the output is full prosodification such as the following (p. 136).

Input: [ <sub>CP</sub> Verb [ <sub>DP</sub> Subject] [ <sub>VP</sub> t <sub>V</sub> [ <sub>NP</sub> Object]]]	STRONGSTART	MATCH( $\phi$ ,XP)	MATCH( $\phi$ ,XP)
a. $\mathcal{E}$ ((Verb Object) $\phi$ (Subject) $\phi$ ) $\iota$		*	*
b. ((Verb (Object) $\phi$ ) $\phi$ (Subject) $\phi$ ) $\iota$	*!	*	
c. (((Verb) $\phi$ (Object) $\phi$ ) $\phi$ (Subject) $\phi$ ) $\iota$		**!	



constituency. I include prosodification here to be thorough in including all major spell-out operations, and to establish the contrast to grammatical tone. The model which I will propose in the following chapters is not wedded to Match Theory, or really any prosodification theory.

Finally, hierarchy exchange translates syntactic hierarchical relations (the syntactic tree) into morpho-phonological hierarchical relations (the morpho-phonological tree, shown at the bottom of the phonological image \mathcal{P} in Figure 9). As I discuss below, hierarchy exchange is crucial for establishing the scope of phonological operations triggered by specific vocabulary items.

Definitions of these spell-out operations are below.

- [Def 2] **Vocabulary insertion:** Insertion of vocabulary items with phonological material (i.e. phonological exponents), from the Vocabulary list
  
- [Def 3] **Linearization:** Establishing linear precedence relations for each vocabulary item
  
- [Def 4] **Prosodification:** Establishing prosodic constituency between the vocabulary items
  
- [Def 5] **Hierarchy exchange:** Exchanging syntactic hierarchical relations (the syntactic tree) for morpho-phonological hierarchical relations (the morpho-phonological tree)

Additionally, the interface literature contains many different kinds of spell-out operations. Some of these include allomorphy selection, bundle manipulation of morphosyntactic features (i.e. DM operations ‘fusion’ and ‘fission’, the insertion/deletion of morphosyntactic features via ‘dissociated node insertion’, ‘enrichment’, ‘impoverishment’, *etc.*), economy conditions (e.g. multiple copy resolution, deletion-under-identity), and even syntax-like operations such as DM’s ‘lowering’ (movement of  $X^\circ$  down to its closest head it c-commands). Recently, a counterpart to lowering called ‘raising’ has been forwarded (Harizanov & Gribanova 2018), in which word-building head movement is reinterpreted as strictly post-syntactic (this analysis following Chomsky 2001:37, Schoorlemmer & Temmerman 2012, a.o.; see this latter work for other references to this idea). We will return to head-movement as a post-syntactic operation in section 4.4.4.1 below.

One novel contribution I make with this study is the idea that all of these spell-out operations as taking place in parallel. Such a model of spell-out can easily be formalized within an Optimality Theoretic model consisting of the input (the syntactic image) and a list of potential outputs from GEN (the phonological image) which are evaluated against a constraint ranking (from CON). In Figure 9, these spell-out operations are given in list form to indicate that there is no order to their application. I call this assumption of parallelism the **morphology-in-parallel hypothesis**, defined below.

- [Def 6] **Morphology-in-parallel hypothesis (MPH)**  
Spell-out operations involved in mapping the syntactic image / S / to the phonological image \mathcal{P} take place in parallel within an OT architecture (involving CON, EVAL, GEN, etc.)

That post-syntactic operations take place in parallel is at odds with the majority of DM, e.g. the well-articulated operation orders put forward in Embick & Noyer (2001) and Arregi & Nevins (2012). To distinguish my assumptions from mainstream DM, I call this approach assuming parallelism ‘Optimality Theoretic Distributed Morphology’ (or OT-DM). Although this approach

is unorthodox, there is a growing body of literature which supports such an OT-DM model (Trommer 2001a, 2001b, 2002; Sande 2017; Dawson 2017; Foley to appear, Rolle accepted).<sup>8</sup>

Two of these spell-out operations require special discussion in order to fully understand the analysis of grammatical tone in the chapters which follow this one. These are ‘vocabulary insertion’ and ‘hierarchy exchange’.

#### 4.4.3 Vocabulary insertion

The DM notion of vocabulary insertion was defined as the following:

- (15) **Vocabulary insertion:** Insertion of vocabulary items with phonological material (i.e. phonological exponence), from the vocabulary list

The function of vocabulary insertion is to provide phonological material, the strings of phonemes, tonemes, etc. associated with a particular meaning. Let us go into some details of what this entails.

As seen in Figure 9 above, phonological material is ‘housed’ within vocabulary items. These vocabulary items are pre-built objects which are stored in a list called ‘vocabulary’ (Halle & Marantz 1993). During spell-out, the morpho-syntactic feature bundles are matched and replaced by an appropriate vocabulary item, subject to various DM principles (e.g. the ‘subset principle’ – Halle & Marantz 1993:122, Embick 2015:95). Within DM terminology, this is referred to as ‘late insertion’ of phonological material, and is why DM is understood as a realizational model of morphology (see Stump 2001 for meta-discussion of realizational vs. non-realizational models of morphology).

To illustrate, recall the structure of <cats> from above in Figure 6, repeated in the structure to the left in Figure 10 below. At the point of vocabulary insertion, the bundles are replaced with two vocabulary items. This is schematically illustrated in (16).<sup>9</sup> Note that this representation on the right is given for expository purposes only; because I assume parallelism, no representation with mixed phonological and syntactic structure ever exists.

- (16) Vocabulary Items for *cats*
- |    |                    |   |       |
|----|--------------------|---|-------|
| a. | [ <i>n</i> ][VCAT] | ↔ | /kæt/ |
| b. | [+PL]              | ↔ | /-z/  |

---

<sup>8</sup> Rolle (accepted) overviews several other works which envision more broadly some type of interaction between DM and OT assumptions, including early work in Noyer (1992, 1994) and Bonet (1994), and more recent work in Don & Blom (2006), Opitz (2008), Haugen (2008, 2011), Wolf (2008), Lahne (2010), Tucker (2011), Keine & Müller (2015), Brown (2017), a.o.

To take but one operation, vocabulary insertion is often understood as moving inside-out cyclically, and not exponing all bundles in parallel (e.g. Bobaljik 2000). However, more recently a number of cases have been identified which support VI being sensitive to morphosyntactic features in non-local terminal heads (e.g. Merchant 2015, Moskal & Smith 2016), which necessitates access to non-local VIs within a representation. A parallel model is a straightforward way to do so. Furthermore, vocabulary insertion can be sensitive to both phonological and morphosyntactic features, and both when they occur inward or outward (contra Bobaljik 2000), e.g. outward-sensitive phonologically-conditioned allomorphy in Nez Perce (Deal & Wolf 2016). Therefore phonological information of ‘outward’ VIs must be visible to condition VI allomorphy, which is easily modeled with simultaneous insertion.

<sup>9</sup> This is formatted for the most part following Embick (2015), but I deviate from his schema by not assuming that the categorizing head [*n*] would be exponed with a /Ø/ exponent.

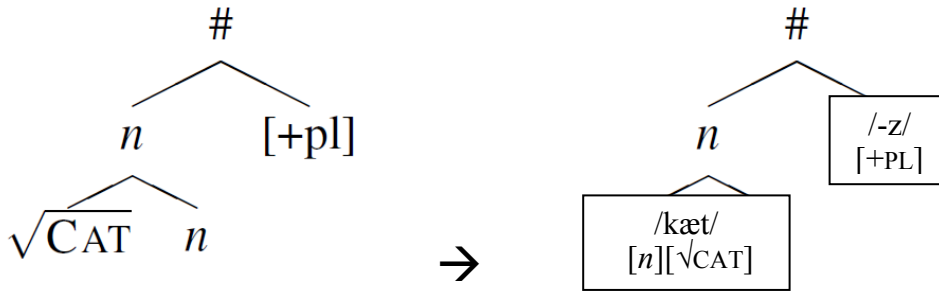

Figure 10: Vocabulary insertion for *cats*

Vocabulary items have complex internal structure. I broadly follow Sande & Jenks (2017) in positing that VIs minimally consist of the content in (17). I modify their representation to include a VI label and morphosyntactic content (*M*).

- (17) Content of vocabulary items (VIs)
- VI label: Unique name of the VI (for identificational purposes only)
  - Morphosyntactic content (*M*): Morphological features (paired to morphosyntactic/SynSem features in the syntax)
  - Featural content (*F*): Tonal or segmental features
  - Prosodic content (*P*): Prosodic selection or subcategorization
  - A constraint subranking (*R*): A partial constraint ranking, which overrides a default master constraint ranking

The conventional representation of the internal structure of VIs is below.

- (18) Vocabulary item structure:

$$\left\{ \begin{array}{l} \text{VI label} \\ M: [+F] \\ F: /-x/ \\ P: (\omega (\omega \dots) \underline{\quad}) \\ R: C_2 \gg C_3 \gg C_1 \end{array} \right\}$$

In this hypothetical example, this VI is inserted when the morphosyntactic context is [+F] (in *M*). The VI expones this as a phonological sequence /-x/ (in *F*) which selects a prosodic word and must occur in a prosodic word as well resulting in recursion (in *P*). Finally, this VI imposes a constraint ranking  $C_2 \gg C_3 \gg C_1$  in the relevant domain (*R*), overriding any default constraint order. Note that not all VIs have all these rows overtly filled. For example, the VIs in <cats> in Figure 10 above do not impose special prosodic selection (*P*) or constraint subranking (*R*); these would thus be left blank which I will conventionalize with a slash, e.g. { *P*: - }.<sup>10</sup>

<sup>10</sup> The structure of vocabulary items resembles ‘attribute-value matrices’ in Sign-Based Morphology (Orgun 1996), with similar structures in other theories. For example, Orgun & Inkelas (2002:121) present the following structure for the morpheme ‘book’:

$$\left[ \begin{array}{l} \text{SYNSEM} \left[ \begin{array}{ll} \text{CAT} & \textit{noun} \\ \text{SEM} & \text{'book'} \end{array} \right] \\ \text{PHON} & \text{bʊk} \end{array} \right]$$

#### 4.4.4 Hierarchy exchange

The other spell-out operation crucial to understanding the analysis of GT is hierarchy exchange, which I innovate in this study. This operation was defined as the following:

- (19) **Hierarchy exchange:** Exchanging syntactic hierarchical relations (the syntactic tree) for morpho-phonological hierarchical relations (the morpho-phonological tree)

The result of this operation is the morpho-phonological tree seen at the bottom of the phonological image  $\mathcal{S}$  in Figure 9 above. Informally, this operation exchanges syntactic notions of ‘upward’ and ‘downward’ for morphological notions of ‘outward’ and ‘inward’. The main function of hierarchy exchange is to establish the scope of phonological operations triggered by specific vocabulary items, as seen in this figure where individual nodes are denoted as *CoP* standing for cophonology-scope.

Let us return to the phonological image, the relevant portion of which is provided below which focuses on the morpho-phonological tree, the result of hierarchy exchange.

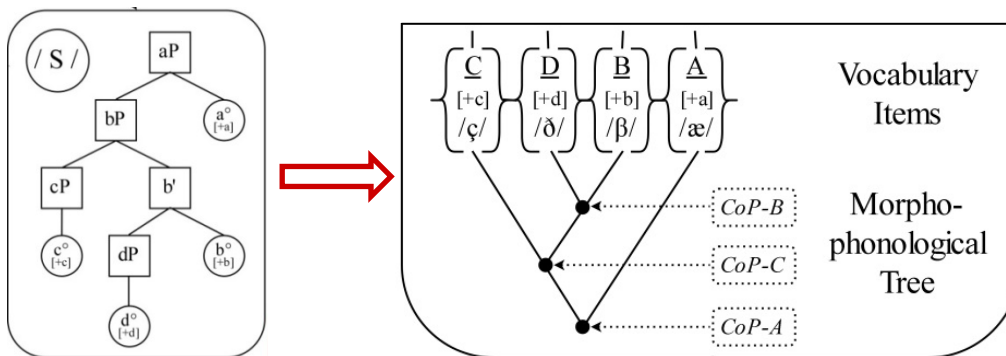

Figure 11: Morpho-phonological tree (the result of hierarchy exchange)

Hierarchy exchange maps the syntactic configurations of the morpho-syntactic image  $/S/$  in highly specific ways. These are shown in the table below.

	Syntactic configuration		Morpho-phonological tree	
a.	Head-Comp	$[b_P [d_P d^\circ] b^\circ]$	a. B	b. B
b.	Head-Head	$[b_P [d_P d^\circ] b^\circ + d^\circ]$	$\begin{array}{c} / \quad \backslash \\ \{D\} \{B\} \end{array}$	$\begin{array}{c} / \quad \backslash \\ \{B\} \{D\} \end{array}$
c.	Spec-Head	$[b_P [c_P c^\circ] [b' [d_P \dots] b^\circ]]$	i. $\begin{array}{c} C \\ / \quad \backslash \\ \{C\} \{B\} \end{array}$	ii. $\begin{array}{c} C \quad B \\   \quad   \\ \{C\} \{B\} \end{array}$
d.	Spec-Head-Comp	$[b_P [c_P c^\circ] [b' [d_P d^\circ] b^\circ]]$	i. $\begin{array}{c} C \\ / \quad \backslash \\ / \quad B \\ / \quad / \quad \backslash \\ \{C\} \{D\} \{B\} \end{array}$	ii. $\begin{array}{c} C \quad B \\   \quad / \quad \backslash \\ \{C\} \{D\} \{B\} \end{array}$

Table 1: Hierarchy exchange

Hierarchy exchange is determined in large part by asymmetrical c-command. I will first describe the rows, then turn our discussion to technical aspects of c-command.

Row a. represents the relations between sisters  $b^\circ$  and  $dP$  in Figure 11, a head-comp configuration (the most deeply embedded structure). Here, the head  $b^\circ$  asymmetrically c-commands the head  $d^\circ$ . Recall from the previous section that I deviate from assumptions of bare phrase structure by assuming that all  $X^\circ$ 's are embedded within an XP. The counterpart morpho-phonological tree shows that the VIs  $\{\underline{D}\}$  and  $\{\underline{B}\}$  expone the nodes  $d^\circ$  and  $b^\circ$  via the operation vocabulary insertion, detailed above. Because  $b^\circ$  asymmetrically c-commands the head  $d^\circ$ , the two VIs are connected via a node which is labeled B. It is always the outermost VI which labels the node. In this case,  $\{\underline{B}\}$  is the outer element and  $\{\underline{D}\}$  is the inner element, inner/outer relations being familiar to morpho-phonological analysis. In line with DM principles, I take these relations to hold above and below the 'word'. Labelling essentially represents the fact that the scope of phonological operations is the node B consisting of  $\{\underline{D}\}\{\underline{B}\}$ , as explained below.<sup>11</sup>

Row b. shows the same structure but where the lower  $d^\circ$  head has undergone head movement to adjoin to  $b^\circ$ , thereby forming a complex head. As shown in the morpho-phonological tree, while this operation may result in differences such as linear order changes (subject to the operation linearization), it does not affect the labeling of the node as B.

Furthermore, row c. involves a specifier-head (spec-head) relation, where  $cP$  is in the specifier position of  $bP$ . I claim that hierarchy exchange can map the spec-head configuration in two ways. In one way (i.), the two VIs form a single unit united just as in the head-comp/head-head configurations. In this type, the VI which is in specifier position dictates the label of the entire unit, which in this case is labelled C. Thus the specifier is considered 'outer' and the head is considered 'inner' in this morpho-phonological tree. In the other type (ii.), both the specifier VI  $\{\underline{C}\}$  and the head VI  $\{\underline{B}\}$  are mapped separately and do not form any unit. Neither of them is considered outer compared to the other. Finally, row d. shows an XP with its specifier, head, and complement positions filled, and the two potential complex morpho-phonological trees.<sup>12</sup>

#### 4.4.4.1 The role of c-command

Hierarchy exchange crucially relies on **asymmetrical c-command** (Reinhart 1976), which is a common focus in the syntax/phonology interface literature (most relevant to this study being McPherson 2014 and McPherson & Heath 2016). A classic definition of c-command is below from Uriagereka (2012:121). This crucially involves the issue of 'syntactic dominance' (distinct from 'tonological dominance'): in short a mother node is higher than its daughter node and as such 'dominates' it.

- (20)  $\alpha$  c-commands  $\beta$  if and only if (i) and (ii):
- (i)  $\alpha$  does not dominate  $\beta$
  - (ii) all nodes dominating  $\alpha$  dominate  $\beta$

<sup>11</sup> As such, labelling in the morpho-phonological tree is parallel to Minimalist conceptions of node labelling. This is succinctly summed up by Epstein (1999:341), citing Chomsky (1994):

*"when two categories A and B are merged, they form a new category whose label is identical to the head of either A or B (. . . Merge . . . is asymmetric, projecting one of the objects to which it applies, its head becoming the label of the complex formed"; Chomsky 1994,11)."*

<sup>12</sup> Conspicuously absent here is discussion of syntactic 'adjuncts'. In much Minimalist discourse, the distinction between specifiers and adjuncts is neutralized, and as such I assume that adjuncts will pattern as specifiers. Many linguistic categories typically understood as adjuncts (e.g. adverbials, intensifiers, some prepositional phrases, etc.) are neither triggers nor targets of GT patterns, so testing this prediction will require further investigation. I leave the issue of adjuncts aside here consequently.

However, as discussed in Bruening (2014:355-358), particular thorny issues for defining c-command are head-adjunction and phrase-adjunction, necessitating several modifications in the literature. One such reanalysis is actually proposed by Reinhart herself (Reinhart 1976:148, discussed in Bruening 2014:355)<sup>13</sup>, and prominently in Kayne (1994). It is Kayne's definition of c-command which we will use in this study.

Kayne (1994) presents a theory of Antisymmetry whose central tenet is the 'Linear Correspondence Axiom': the linear order of terminal nodes in a syntactic tree is determined strictly by their c-command relations. He posits that the linear word order [Spec-Head-Comp] is universally derived from c-command relations: heads c-command their complements and specifiers c-command the head-comp constituent. Surface deviations such as in head-final languages are the result of syntactic movement.

He defines c-command as follows:

- (21) Definition of c-command (Kayne 1994:18):  
*X c-commands Y iff X and Y are categories and X excludes Y and every category that dominates X dominates Y*

Let us illustrate this with a diagram from Kayne (1994:23). Kayne's diagram is in Figure 12, followed by a modified version of this diagram in Figure 13 which labels the nodes as specifier, head, and complement respectively.

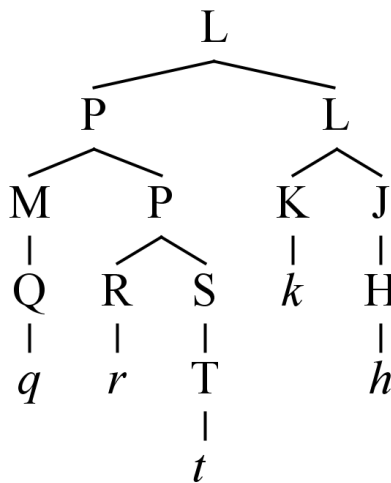

Figure 12

<sup>13</sup> Revised c-command (Reinhart 1976:148):

Node A c(onstituent)-commands node B iff the first branching node  $\alpha_1$  dominating A either dominates B or is immediately dominated by a node  $\alpha_2$  that dominates B, and  $\alpha_2$  is of the same category type as  $\alpha_1$ .

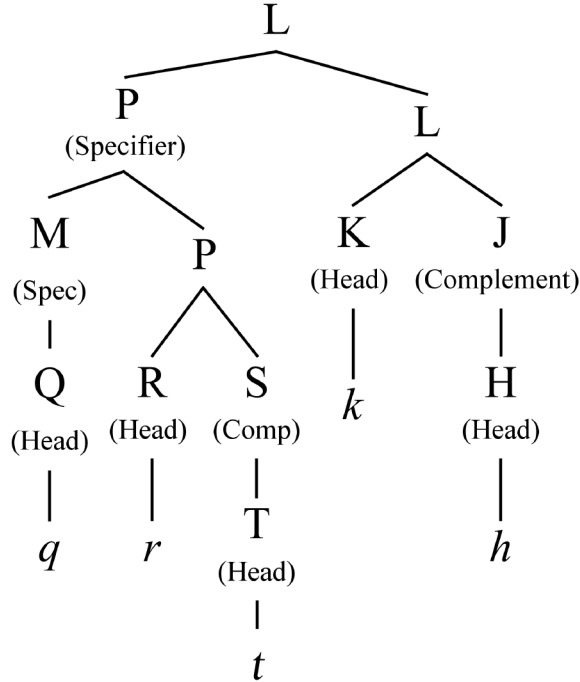

Figure 13: Modified figure with positions indicated

Let us begin by examining head-comp configurations. According to Kayne’s definition of c-command above, heads asymmetrically c-command their complement’s head (standard in every definition of c-command). Thus, in this tree R c-commands T and K c-commands H. As shown in (22) below, Kayne states that because the asymmetrical c-command relations  $\langle R, T \rangle$  and  $\langle K, H \rangle$  exist, this necessarily results in the linear order of the terminal elements  $\langle r, t \rangle$  and  $\langle k, h \rangle$  (given in lower case and also italics for clarity, as in (22)a.-b.).

(22)	<u>C-command</u>	<u>Linear order</u>	d.	<u>C-command</u>	<u>Linear order</u>
a.	$\langle R, T \rangle$	$\langle r, t \rangle$		$\langle M, K \rangle$	$\langle q, k \rangle$
b.	$\langle K, H \rangle$	$\langle k, h \rangle$		$\langle M, J \rangle$	$\langle q, h \rangle$
c.	$\langle P, K \rangle$	$\langle r, k \rangle, \langle t, k \rangle$		$\langle M, H \rangle$	$\langle q, h \rangle$
	$\langle P, J \rangle$	$\langle r, h \rangle, \langle t, h \rangle$		$\langle M, R \rangle$	$\langle q, r \rangle$
	$\langle P, H \rangle$	$\langle r, h \rangle, \langle t, h \rangle$		$\langle M, S \rangle$	$\langle q, t \rangle$
				$\langle M, T \rangle$	$\langle q, t \rangle$

Let us now examine spec-head relations, the elements P and M above. Important for our study is the claim that specifiers c-command out of their containing phrase, with Kayne stating that:

*“This property is due to the union of two factors. The first is that the LCA forces specifiers to be analyzed as instances of adjunction (otherwise, a specifier and its sister phrase would be too “symmetric”). The second is the definition ... of c-command in terms of category dominance (rather than segment dominance).”*

[Kayne 1994:27]

In the tree in Figure 13, let us examine the relationship between P (the specifier) and L (the phrase which P is the specifier of – i.e. the containing phrase). Kayne crucially invokes

Chomsky's (1986:9) notion of exclusion as a necessary precursor to c-command, defined as "A excludes B iff no segment of A dominates B". In the tree, there are two nodes labeled L (e.g. a tree with XP and X' in class X-bar theory) and as such L does not 'exclude' P. Thus L (the containing phrase) does not c-command P (the specifier) because it does not exclude it.

Instead, Kayne holds that the opposite is true: that specifiers such as P asymmetrically c-command the head (and complement) of the containing phrase. Here, P (the specifier) excludes L and the clause of c-command that 'every category that dominates X dominates Y' is vacuously satisfied (there is nothing above L). Thus, this is why Kayne notes that specifiers such as P can 'c-command out'.

Put into action, the specifier P c-commands K (head), J (its complement), and H (the head of the complement), resulting in <P,K>, <P,J>, <P,H> in (22)c. above. For <P,K> for example, P has two terminal nodes *r* and *t* and K has one *k*, thus this maps to linear order relations <*r,k*> and <*t,k*>.

Finally, let us examine the embedded specifier M and its containing phrase P. Embedded specifiers also c-command out, c-commanding the head-comp of the containing phrase, *as well as* the head-comp of the matrix containing phrase in this case. Thus M c-commands R, S, and T, as well as K, J, and H. Regarding these data, Kayne states the following:

*"This type of phrase marker takes on particular interest when we recall that in the theory being developed here specifiers are an instance of adjunction. Therefore, M in [Figure 13 above] could just as well be a specifier of P and P a specifier of L – in which case the specifier of the specifier of L would asymmetrically c-command K and J and everything dominated by K and J. Taking L = IP, K = I, and J = VP, we reach the conclusion that the specifier of the subject of IP asymmetrically c-commands I and VP and everything within VP."*

[Kayne 1994:23]

This then results in a series of c-command relations involving M and subsequent linear order, shown in (22)d. Taken together, the final linear order is < *q r t k h* > in which specifiers precede heads and head precede complements (here: < [SPEC HEAD COMP]<sub>SPEC HEAD COMP</sub> >).

The reader should note that by adopting this definition of c-command, I do *not* adopt the idea the linearization is determined by c-command, which is a separate issue entirely. I have sought to illustrate how c-command was used by Kayne to explain a piece of the syntax-phonology interface, but I do not actually deal with linearization in this study at all as it is for the most part orthogonal to explaining grammatical tone. The real legacy of c-command in phonology may in fact not be in linear order but rather be in the scope of morphophonological operations, as manifested by grammatical tone.

Let us now return to hierarchy exchange, which maps the following syntactic configurations to morpho-phonological trees repeated in Table 2 below.

Syntactic configuration		Morpho-phonological tree	
a.	Head-Comp [ <sub>bP</sub> [ <sub>dP</sub> d° ] b° ]	a. B / \ { <u>D</u> } { <u>B</u> }	b. B / \ { <u>B</u> } { <u>D</u> }
b.	Head-Head [ <sub>bP</sub> [ <sub>dP</sub> e° ] b°+d° ]		
c.	Spec-Head [ <sub>bP</sub> [ <sub>cP</sub> c° ] [ <sub>b'</sub> [ <sub>dP</sub> ... ] b° ] ]	i. C / \ { <u>C</u> } { <u>B</u> }	ii. C B     { <u>C</u> } { <u>B</u> }

Table 2: Hierarchy exchange



Using this definition of c-command captures row a. (the head-comp configuration) and result (i.) of row c. (the spec-head configuration). I will leave out discussion of the other type of morpho-phonological tree which can result from spec-head configurations in c., namely the one in (ii.) where the specifier and head do not form a unit. We can view this aspect of hierarchy exchange as parameterizable, and I leave this for future research. What is important is that the opposite is not found: a spec-head configuration where the head is ‘outer’ compared to the specifier.

This leaves us with explaining the behavior of head-head configurations, such as a complex head the result of head movement. According to the definition defined by Kayne, the head which moves adjoins to the stationary head and as such it would c-command out of this complex head. Thus, according to the definition of c-command we adopt, heads which move should act in a parallel way to specifiers. This would lead to a number of unwanted repercussions, for example, a lexical root which moves to combine with higher functional head, and because it is the moving head which adjoins and c-commands out, it is the ‘outermost’ element. When we return to grammatical tone, this would predict that lexical roots would assign dominant GT to the affixes which it combines with, which is the opposite of what is attested: affixes assign dominant GT to roots and *not* vice versa. Thus we need the *in situ* positions of heads to be what counts for c-command and not their surface positions.

Fortunately, there is growing and extensive evidence that head movement is actually a *post*-syntactic operation and thus complex head-head configurations are formed after syntactic relations such as c-command are ‘finalized’, so to speak. This has been cogently argued in recent work in Harizanov & Gribanova (2018) as mentioned above, supporting an earlier statement in Chomsky (2001:37) (see also Schoorlemmer & Temmerman 2012 for context in the literature). Instead of attributing complex heads to syntactic ‘head movement’ as is done by default, Harizanov & Gribanova actually attribute their construction to a postsyntactic operation they call ‘amalgamation’ (which in our model would take place at spell-out in parallel to the other operations). As evidence, they cite a number of properties which distinguish it from authentic syntactic movement:

*“word formation is the result of postsyntactic amalgamation, realized as either Lowering (Embick and Noyer 2001) or its upward counterpart, Raising. This operation, we argue, has properties that are not associated with narrow syntax: it is morphologically driven, it results in word formation, it does not exhibit interpretive effects, and it has stricter locality conditions (the Head Movement Constraint)”*

[Harizanov & Gribanova 2018]

The fact that the result of amalgamation is said to not have ‘interpretative effects’ at LF is perhaps the best indication that this is a PF phenomenon, as this would be expected given that PF and LF branch off at spell-out and thus could not influence each other. Given this, I will assume that the head-head configuration in Table 2 above [<sub>bp</sub> [<sub>dp</sub> e° ] b°+d° ] is formed only post-syntactically, and thus complex heads are uniformly derived from syntactic head-comp configurations with straightforward c-command relations.

#### 4.4.4.2 Hierarchy exchange entails an indirect reference model

By invoking c-command, this model follows a long lineage of approaches to the syntax/phonology interface which capitalize on this central syntactic notion in accounting for morpho-phonological phenomena (Kaisse 1985; Kayne 1994; Holmberg and Odden 2008; McPherson 2014; McPherson & Heath 2016; a.o.). This model most closely resembles that of McPherson (2014) in that the ultimate empirical content justifying interface design is

grammatical tone. However, while McPherson’s work (and that of many others) constitutes a **direct reference theory**, the one posited here is diagnosed as an **indirect reference theory**.

This distinction is an old one used to typologize interface models along a single parameter. Direct reference theories of the interface assume that phonological operations can directly access syntactic categories and structure, e.g. an operation referring to a (morpho)syntactic feature [NOUN], [VERB], or [PLURAL], a syntactic position head vs. specifier, or a syntactic relation such as c-command. In contrast, indirect reference cannot reference this syntactic information, as summed up by Scheer (2011):

*“The principle of Indirect Reference holds that morpho-syntactic categories are invisible to the phonology: phonological processes cannot make direct reference to them. Rather, morpho-syntactic structure needs to be translated into phonological vocabulary, the Prosodic Hierarchy, to which phonological processes may then appeal.”*

[Scheer 2011:318]

As Scheer states, the crucial analytic move in indirect reference models is to ‘translate’ the relevant syntactic information into equivalent phonological information which it can access, e.g. prominently the prosodic hierarchy. Both these approaches encompass a broad range of subtypes and thus only crudely distinguish interface theories. Some commonly cited direct reference work include Kaisse (1985), Odden (1987), Pak (2008) and McPherson (2014), while indirect reference include Nespov & Vogel (1986) and seminal works on prosodic hierarchy and constituency (e.g. Selkirk 1984).<sup>14</sup>

Let us return to our conception of spell-out as cross-module translation, as shown below.

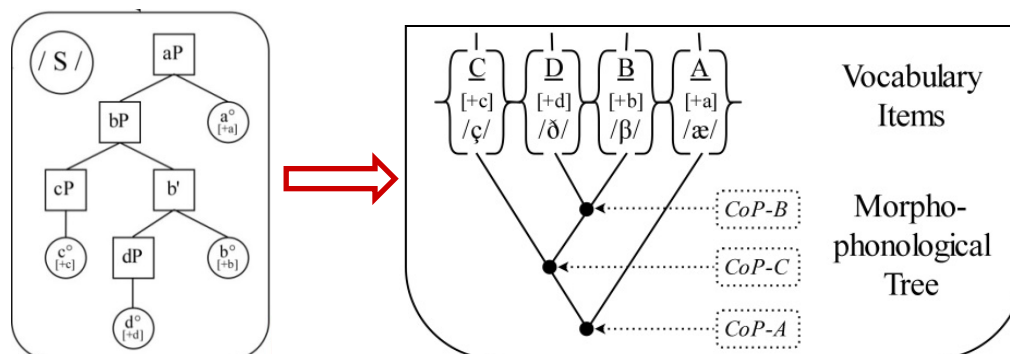

Figure 14: Morpho-phonological tree (the result of hierarchy exchange)

In this figure, the syntactic tree is translated to a morpho-phonological tree via hierarchy exchange. The diagram includes dotted arrows to the nodes where phonological constraints at each node (to be explained shortly). The application of these phonological constraints themselves do *not* refer to syntactic information housed within the morpho-syntactic image /S/, and can only access the output of spell-out being the morpho-phonological image \2\. Spell-out only provides the actuation of phonology as shown in (14) above; it is not the phonological grammar and as such does not actually perform any phonological operations.

Thus, after spell-out the morpho-phonological module no longer has access to syntactic information from the previous module such as syntactic categories and – crucially for our purposes – syntactic relations such as c-command. Because the phonological grammar cannot

<sup>14</sup> For a critical examination of direct vs. indirect reference models, see in particular Scheer (2011:318-361).

access c-command directly and only feels its effects as a result of hierarchy exchange, the model I have sketched must be understood as an indirect reference model. Thus, c-command plays a major role in modelling the interface, albeit an *indirect* one.

A direct reference model has a number of conceptual advantages over an indirect model, e.g. c-command is needed independently for a number of syntactic phenomena and it would therefore lead to a more parsimonious model of language if it can be invoked in phonology as well.<sup>15</sup> McPherson (2014) incorporates c-command's central role in phonology by defining construction constraints which directly refer to it:

(23) X ADJ: Words c-commanded by an adjective take {L} tone

[Tommo So - McPherson 2014:78]

We therefore must find good grounds to dismiss it.

I adopt an indirect reference model for the following reasons. First, a conceptual argument: if we take the idea of feed-forward modular architecture seriously, then the null hypothesis should be that after spell-out there should be no communication between the two modules. Thus, phonology should not have access to c-command relations, only the output of spell-out (i.e. the morpho-phonological tree). Moreover, in any model which requires cycles within the phonological module (which I advocate here based on GT evidence), then a direct reference model in fact requires *sustained* direct reference to the syntactic module at every cycle.

A second argument involves c-command itself. Above, I adopted the position that complex heads usually attributed to syntactic head movement are actually due to a post-syntactic operation 'amalgamation' following Harizanov & Gribanova (2018). This allowed us to say that within the syntax, a head always asymmetrically c-commands the head of its complement. By relegating complex head formation to spell-out, this avoids predictions of phonological behavior not attested for grammatical tone. However, if we invoke direct reference to c-command, it is not clear which structure we will directly refer to: the head-comp configuration of syntax where one set of c-command relations holds, or the post-syntactic head-head configuration where an opposite set of c-command relations would hold.

Third, at spell-out we have envisioned that vocabulary insertion pairs vocabulary items with features present in the syntax. As indicated in the tree to the left in Figure 14 above, these feature bundles occur at  $X^\circ$  and can be understood as the contents of the head of the XP. As such, when vocabulary insertion takes place it is the  $X^\circ$  position which is referenced and replaced, not the entire XP. This therefore makes direct reference to c-command complicated. In a spec-head configuration for example, the specifier as a whole c-commands out of its containing phrase and thus c-commands the head. However, the *head* of the specifier itself does *not* c-command out of the specifier position. It is therefore not sufficient for a constraint to directly refer to the c-command relations of a VI; it must also access the structural configuration of the containing phrase of the head exponed as the VI. Thus, for the phrase 'this job stinks', the subject 'this job' in specifier position c-commands out, but the head of the specifier 'this' does not. By invoking an indirect reference to c-command mediated by hierarchy exchange, we avoid this issue entirely.

To conclude this discussion, we might be able to get around the problem of heads c-commanding out of their specifier by assuming an aspect of bare phrase structure which I did not adopt above (section 4.4.4.1): namely, that heads are only embedded within an XP phrase when that phrase is branching (the no unary branching condition). Thus, where in Figure 14 I have

---

<sup>15</sup> See however Bruening (2014) for arguments against c-command even in syntax.

DP—d°, bare phrase structure would have just d° (or still yet, d or D). This, however, creates a new problem. Under bare phrase structure, X° complements would look like the following (and be indistinguishable from spec-head configurations that lack a complement):

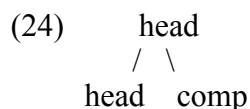

In this configuration, under one interpretation complements would c-command out of the head XP, and in another interpretation both of these symmetrically c-command one another, e.g. under Epstein’s (1999:329-332) definition of ‘derivational c-command’ where merge and c-command are intimately connected. Both of these would predict patterns not seen: grammatical tone patterns where VIs corresponding to complements assign dominant GT to their heads (a clear gap in this typology).

In total, hierarchy exchange and the resulting morpho-phonological tree allow us to obtain strict modularity while retaining the fundamental role of c-command in constraining phonological patterns, but also being flexible enough to handle non-isomorphy when it should arise. This is the reasoning behind the analytic choices I have made in this section.

#### 4.4.5 *Post-spell-out: From hierarchy exchange to cophonology-scope*

Hierarchy exchange as part of spell-out results in a mapping between a syntactic tree and a morpho-phonological tree. We have talked extensively at this point of the mechanics of hierarchy exchange, but have yet to fully explicate its function. The goal of this section is to show that hierarchy exchange establishes the ‘scope’ of phonological operations, which I call **cophonology-scope** (an extension of **stem scope** - Inkelas & Zoll 2007).

Before we proceed further, let’s briefly examine the backdrop of this proposal for cophonology-scope and what it is meant to capture. Grammatical tone is part of a substantial body of data showing phonological operations applying only in the context of a subset of morphemes and morphosyntactic constructions, classified as **morphologically-conditioned phonology**. One prominent account of this phenomenon is Cophonology Theory (CPT). A noted advantage of CPT is its ability to integrate morphologically-conditioned phonology in the same theory as non-concatenative/process morphology (Inkelas 2014:80).

In the original work in CPT, researchers captured morphologically-conditioned phonology by associating each morphological constituent or lexical class with a fully general phonological grammar (Orgun 1996; Anttila 1997, 2002; Inkelas 1998; Orgun & Inkelas 2002, Inkelas & Zoll 2005, 2007; a.o.).<sup>16</sup> For example, in Turkish some affixes trigger glide-insertion to repair vowel hiatus such as /-uundʒa/ ADVERBIAL in (25)a, while other affixes trigger vowel deletion such as /-ujor/ PROGRESSIVE in (25)b.<sup>17</sup>

(25) Cophonologies with distinct rankings

a. Insertion

/anla-ma-uundʒa/  
‘understand-NEG-ADV’

[anlamajundʒa]  
\*VV » MAX-V » DEP-C

<sup>16</sup> Pater (2007) refers to discussion of morpheme-specific rankings going back even earlier, e.g. Nouveau (1994). See also Tsay (1990) for a pre-OT analysis involving metrical parameter changes comparable to cophonologies.

<sup>17</sup> I ignore what the underlying vowel is of the suffix, if there is one, or just an ‘archiphoneme’ /I/.

b. Deletion

/anla-ma-**u**jor/  
‘understand-NEG-PROG’

[anlamujor]  
\*VV » DEP-C » MAX-V

[Turkish – Inkelas & Zoll 2007:135]

From these data, we can see the same input sequence /...a-u.../ is mapped to an output \...ajw...\  
or \...u...\  
depending on morphological context. We can understand these as involving two different cophonologies associated with the morphological context, Cophonology A (CoP-A) and Cophonology B (CoP-B) respectively, with different ranking of DEP-C and MAX-V (Inkelas & Zoll 2007:137).

CPT has traditionally been envisioned as directly linked to word formation within lexicalist morphological theories such as Sign-Based Morphology (Orgun 1996) or Optimal Construction Morphology (Caballero & Inkelas 2013). As stated above, I divorce this aspect from CPT and implement it instead within Distributed Morphology (DM) (Halle & Marantz 1993; Embick & Noyer 1999, 2001; a.o.). Crucially, I adopt that vocabulary items themselves are the triggers of the cophonology.

In section 4.4.3 above, I presented the articulated internal structure of vocabulary items (following Sande & Jenks 2017). Within it was a constraint subranking (*R*), which involved a partial constraint ranking which overrides a default master constraint ranking, e.g. { *R*: C<sub>2</sub> » C<sub>3</sub> » C<sub>1</sub> }. For the two Turkish suffixes from (25), we can formulate their VIs as the following:

(26) Turkish VIs with distinct cophonologies

$\left\{ \begin{array}{l} \text{Progressive} \\ M: [+PROG] \\ F: /-ujor/ \\ P: - \\ R: *VV \gg \text{DEP-C} \gg \text{MAX-V} \end{array} \right\}$	vs.	$\left\{ \begin{array}{l} \text{Adverbial} \\ M: [ADV] \\ F: /-umdza/ \\ P: - \\ R: *VV \gg \text{MAX-V} \gg \text{DEP-C} \end{array} \right\}$
--	-----	---

Within each, the constraint ranking in *R* is different, which results in morphologically conditioned phonology.<sup>18</sup>

A major advantage of CPT is that it is intrinsically cyclic, and therefore captures the many **cyclic effects** in the literature. As frequently mentioned, the cycle goes back at least to Chomsky, Halle, & Lukoff (1956), and later cyclicity and its effects were explored via the ‘strict cycle condition’ (Kean 1974, Mascaró 1976, Kiparsky 1982, Cole 1995, Benua 1997, Chen 2000:116, a.o.). As recently well-stated in Kastner (2018), the cycle has stood the test of time especially in its role in accounting for opacity:

*“Studies of opacity effects in phonology have suggested that a “flat” derivation, proceeding wholesale with no internal cycles, cannot account for various phenomena in which the original existence of a certain conditioning environment is made opaque by subsequent operations. A number of frameworks have arisen in order to account for opacity within Optimality Theory, including OT-CC [OT with Candidate Chains] (McCarthy 2007), Harmonic Serialism*

<sup>18</sup> Cophonology theory is similar to Stratal OT in that different morphological constituents can employ distinct constraint rankings (Kiparsky 2000; Bermúdez-Otero 2008, 2011). However, “a standard assumption in Stratal OT (as in late Lexical Phonology) is that there are exactly three levels of evaluation: the Stem Level, the Word Level, and the Phrase Level” (Trommer 2011:72). Cophonology theory does not assume any upper or lower limit on the number of ‘strata’ (Inkelas & Zoll 2007).

(McCarthy 2008a,b; McCarthy and Pater 2016) and OT-OI (Wolf 2008). All share a cyclic spell-out of morphological material.”

[Kastner 2018]

Cyclic effects in the morpho-phonological module manifest in several ways. One is through **obligatory inheritance**, equivalent to the fact that “later evaluations [are forced] to inherit the results of earlier ones” as stated in Steriade (2012:4). In short, an outer cycle cannot halt an inner cycle from operating. This important finding is often framed as a constraint on ‘reaching back’. Cole summarizes this succinctly: “a cyclic rule *R* applying on cycle *j* [is prevented] from reaching back inside an earlier cycle *i* to apply to a string contained wholly within cycle *i*” (Cole 1995:72).

For example, imagine a sequence of three morphemes / [[kile]-iko]-in/, as in (27) where [kile] is the most deeply embedded (the ‘root’ for our purposes).

- (27) Complex structure with three morphemes / kile –iko –in /
- |     |           |                |   |                 |                       |
|-----|-----------|----------------|---|-----------------|-----------------------|
| a.  | Cycle one | / kile –iko /  | → | \ kiliko \      | (Vowel deletion)      |
| b.  | Cycle two | / kiloko –in / | → | \ kilikojin \   | (Consonant insertion) |
| cf. | *         | / kiloko –in / | → | \ kilejikojin \ | Not attested          |

Assume that the first cycle involves the first two morphemes /kile-iko/, and the optimal output is \kiliko\ which has undergone vowel deletion. At the next cycle when the morpheme /-in/ is added, the input-output mapping is /kiloko –in/ → \kilikoj-in\, exhibiting consonant insertion (this is therefore similar to the cophonologies from Turkish in (26) above). What is *not* attested across the vast typology of morpho-phonological patterns is the application of consonant insertion between the first two morphemes but *only* in the context of the outer morpheme /-in/ (hence the \* example below cycle two in b.). Parallel sentiments have been expressed in the literature, from different theoretical perspectives. For example, Pater (2007:18) notes a similar thought experiment:<sup>19</sup>

*“If the ranking introduced by a morpheme holds over the entire string, clearly undesirable results follow.... For example, a language could have a general ranking ONSET >> DEP, which produces epenthesis in vowel-initial stems. If a suffix could introduce a DEP >> ONSET ranking that holds over the entire string, then epenthesis would be blocked word-initially only in the presence of that suffix, as in (45), where /ba/ is the exceptional morpheme.*

- (45) /amana/      [ʔamana]      /amana+da/      [ʔamanada]  
           /amana+ba/      [amanaba]

*A legion of similarly implausible cases could be constructed...”*

[Pater 2007:18]

Capturing cyclicity is built into the fabric of Cophonology Theory (and likewise in sister models such as Stratal OT). Evidence that cophonology application takes place cyclically at each node is well-supported, e.g. numerous cases requiring cyclic application detailed in Inkelas (2014:189-241). CPT cyclicity is schematized based on Inkelas in the figure below, of the hierarchical morphological structure of [ [ [ [ROOT]-SUFFIX<sub>1</sub>]-SUFFIX<sub>2</sub>]-SUFFIX<sub>3</sub>].

<sup>19</sup> Larry Hyman (p.c.) points out a potential case of this in Kikamba [kam], reported by Tom Hinnebusch. Kikamba contains evidence for several ghost consonants which are realized as Ø under hiatus. However, if the stem appears with the diminutive, all of these ghost consonants are realized as [l]. Further investigation is required.

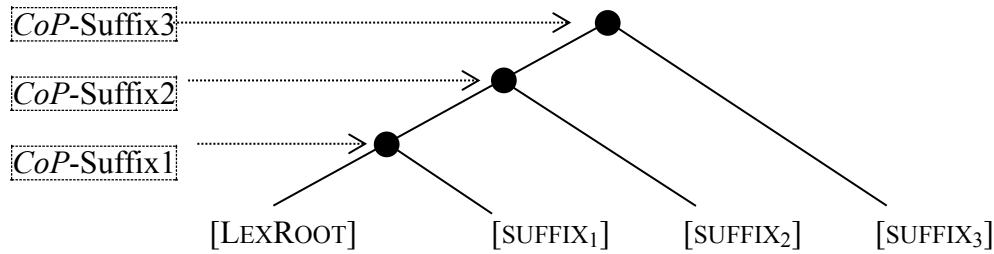

Figure 15 – Morphological structure of [ [ [ [LEXROOT]-SUFFIX<sub>1</sub>]-SUFFIX<sub>2</sub>]-SUFFIX<sub>3</sub> ]

Within a morphological constituent, it is generally assumed across many theoretical frameworks that the lexical root is most deeply embedded and other morphemes are layered above them. At each node of the tree, a fully generally cophonology applies which is triggered by the ‘outer’ element. We can call these *CoP-Suffix1*, *CoP-Suffix2*, and *CoP-Suffix3*.<sup>20</sup>

Within CPT, such morphological structure is subject to what Inkelas & Zoll (2007:144) refer to as **stem scope**.

- (28) **Stem scope**: the scope of morphologically conditioned phonology is the stem formed by the word-formation construction in question

In the figure above, consider a cophonology associated with SUFFIX<sub>2</sub>. The principle of stem scope dictates that it will scope over the subconstituent [ [ [LEXROOT]-SUFFIX<sub>1</sub>]-SUFFIX<sub>2</sub> ] and thus affect the items LEXROOT, SUFFIX<sub>1</sub>, and SUFFIX<sub>2</sub>. It does not and cannot scope over SUFFIX<sub>3</sub>. The concept of **cophonology-scope (CoP-scope)** can thus be seen as a logical extension of stem scope so as to include phrase-level morpho-phonology as well, implemented in the DM framework.

[Def 7] **Cophonology-scope (CoP-scope)**: the scope of the cophonology ranking *R* which is associated with a vocabulary item {VI} is the constituent formed by {VI} with all inwardly located structure

With this as our background, let us return to the morpho-phonological tree, repeated below:

<sup>20</sup> A separate issue often tied in with the phonological cycle is ‘bracket erasure’, referring to the deletion of morphological boundaries in an inner cycle (Siegel 1974, Allen 1978, Pesetsky 1979, Halle et al 1991, Orgun & Inkelas 2002). Inkelas & Zoll (2007) argue that bracket erasure is captured by their notion of ‘locality’:

- (i) **Locality**: the phonological pattern tied to a particular stem will never refer to morphological structure internal to the stem (i.e. “bracket erasure”)

This entails that in a structure [ [ [ROOT-SUFFIX<sub>1</sub>]<sub>STEM</sub>-SUFFIX<sub>2</sub> ], the SUFFIX<sub>2</sub> will scope over and affect the stem as a whole, but it will not have access to its internal structure, i.e. [ROOT-SUFFIX<sub>1</sub>].

It is entirely possible, however, that there could be cyclicity but with no bracket erasure. In this case, the internal structure of previous cycles are visible (we will see evidence for this from phase-protected faithfulness in McPherson 2014). Regardless if inner structures are visible, outer elements cannot block inner processes from applying, and thus cyclicity remains. Informally, whether or not one can see into an inner cycle is separate from whether one can condition it or block it.

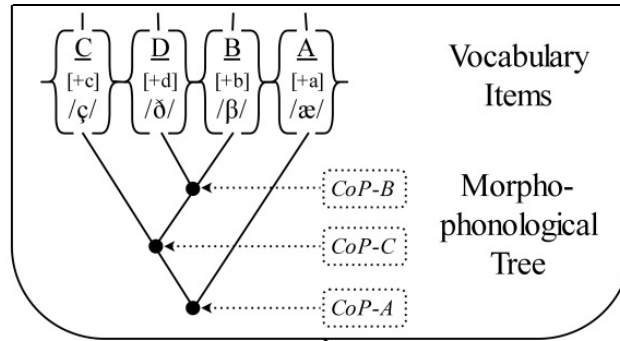

Figure 16: *CoP*-scope within the morpho-phonological tree

A table below illustrates the now familiar head-comp and spec-head configurations based on this figure.

Syntactic configuration	Morpho-phonological tree	Cophonology-scope
Head-Comp [ <sub>bp</sub> [ <sub>dp</sub> d° ] b° ]	$  \begin{array}{c}  B \leftarrow \\  / \quad \backslash \\  \{ \underline{D} \} \{ \underline{B} \}  \end{array}  $	$  \begin{array}{c}  \text{CoP-B:} \\  \{ \underline{B} \} \phi \{ \underline{D} \} \\  \{ \dots \} \phi \{ \dots \}  \end{array}  $
The VI { <u>B</u> } that b° maps to has cophonology-scope over the VI { <u>D</u> } that d° maps to		
Spec-Head [ <sub>bp</sub> [ <sub>cp</sub> c° ] [ <sub>b'</sub> [ <sub>dp</sub> ... ] b° ] ]	$  \begin{array}{c}  C \leftarrow \\  / \quad \backslash \\  \{ \underline{C} \} \{ \underline{B} \}  \end{array}  $	$  \begin{array}{c}  \text{CoP-C:} \\  \{ \underline{C} \} \phi \{ \underline{B} \} \\  \{ \dots \} \phi \{ \dots \}  \end{array}  $
The VI { <u>C</u> } that c° maps to has cophonology-scope over the VI { <u>B</u> } that b° maps to		

Table 3: From hierarchy exchange and cophonology-scope

Head-comp configurations are mapped to a morpho-phonological tree in which the VI { D } is inner (corresponding to the head of the complement) and the VI { B } is outer (corresponding to the head). Spec-head configurations are mapped similarly. This table shows that in head-comp configurations, the outer VI has ‘cophonology-scope over’ anything located ‘inwardly’. I conventionalize ‘have cophonology-scope over’ with the symbol  $\phi$ ; thus, the VI { B } has cophonology-scope over { D } ( $\{ \underline{B} \} \phi \{ \underline{D} \}$ ), and likewise  $\{ \underline{C} \} \phi \{ \underline{B} \}$ ). In the figure, the VI { B } subcategorizes for a specific cophonology (*CoP*-B), which scopes over both the VIs { B } and { D }. This is true moving outward in the tree, such that *CoP*-A (associated with VI { A }) has cophonology-scope over all four VIs { C } { D } { B } { A }.

Taken all together, we therefore have what I call the ***CoP*-scope hierarchy**, shown below. This is simply a schematic representation, as cophonologies do not literally refer to these syntactic categories under the indirect reference model here.

(29) ***CoP*-scope hierarchy**

- a.  $\left\{ \begin{array}{c} \underline{\text{Specifier}} \\ \dots \end{array} \right\} \phi \left( \begin{array}{c} \underline{\text{Head}} \\ \dots \end{array} \right) \phi \left( \begin{array}{c} \underline{\text{Complement}} \\ \dots \end{array} \right)$
- b.  $\text{CoP-Spec} \phi \left( \text{CoP-Head} \phi \text{CoP-Complement} \right)$

This should be interpreted as the following: (i) the VI which corresponds to a specifier position has cophonology-scope over the VI which corresponds to its containing XP’s head, and (ii) this VI itself has cophonology-scope over the VI which corresponds to its complement.



#### 4.4.6 Cophonology-scope and GT

Let us tie this discussion together by returning to our empirical focus, grammatical tone. In chapter 3, we defined dominant GT as resulting in the automatic deletion of the underlying tone of the target-host (with or without replacement), while non-dominant GT does not automatically delete underlying tone. In examining the triggers and targets of these types of GT, we established the dominant GT asymmetry.

- (30) **Dominant GT asymmetry:** within a multi-morphemic constituent, the dominant trigger is a dependent, and the target is a lexical head or a dependent structurally closer to the lexical head

We framed this asymmetry in the typological terms lexical head of a phrase (e.g. N of NP, V of VP) and dependent which includes affixes and modifiers (Nichols 1986). In many cases, the trigger will be a grammatical item and the target will be a lexical item. No such trigger/target asymmetry exists for non-dominant GT. We summarize this below.

Trigger → Target		GT type	Non-dominant (e.g. docking)	Dominant (e.g. replacive)
<b>Grammatical/Dependent</b>	→	<b>Lexical/Head</b>	✓ Yes	✓ Yes
a. Affix	→	Root	✓ Yes	✓ Yes
b. Affix <sub>OUT</sub>	→	[Affix <sub>IN</sub> -Root]	✓ Yes	✓ Yes
c. Modifier	→	Noun	✓ Yes	✓ Yes
d. Modifier <sub>OUT</sub>	→	[Modifier <sub>IN</sub> Noun]	✓ Yes	✓ Yes
e. Object	→	Verb	✓ Yes	✓ Yes
<b>Lexical/Head</b>	→	<b>Grammatical/Dependent</b>	✓ Yes	* No
f. Root	→	Affix	✓ Yes	* No
g. Affix <sub>IN</sub>	→	Affix <sub>OUT</sub>	n/a	* No
h. Noun	→	Modifier	✓ Yes	* No
i. Modifier <sub>IN</sub>	→	Modifier <sub>OUT</sub>	n/a	* No
j. Verb	→	Object	✓ Yes	* No

Table 4: Summary of the empirical base for dominant GT asymmetry

For instance, this table indicates in row a. that if the trigger of the tonal pattern is an affix (such as a functional head) and the target is a lexical root, then the pattern can either dominant or non-dominant. If the trigger and target are flipped as in row b., then only the non-dominant pattern arises. Notice in rows g. and i. that inner affixes and modifiers which assign non-dominant tone to an outer element are missing (marked n/a for ‘not available’), as introduced in Chapter 3. It is yet to be determined whether this is an accidental gap or not.

This table falls naturally out of the model sketched here involving syntactic positions, hierarchy exchange, and cophonology-scope. For a spec-head-comp configuration, hierarchy exchange maps specifiers to the outermost position and complements to an innermost position. This therefore results in the **CoP-scope hierarchy** in which cophonologies associated with heads scoping over their complements, and cophonologies associated with specifiers scoping over both. If we adopt that dominant GT is triggered by a special cophonology, then we can tie these independent notions together, as shown in the table below.

Dominant GT asymmetry (trigger→target)		Syntactic configuration	Obeys <i>CoP</i> -scope hierarchy	
a.	Affix → Root	Head-Comp	<i>CoP</i> -Head $\phi$ <i>CoP</i> -Comp	Yes
b.	Affix <sub>OUT</sub> → [Affix <sub>IN</sub> -Root]	Head-Comp	<i>CoP</i> -Head $\phi$ <i>CoP</i> -Comp	Yes
c.	Modifier → Noun	Head-Comp ~ Spec-Head	<i>CoP</i> -Head $\phi$ <i>CoP</i> -Comp ~ <i>CoP</i> -Spec $\phi$ <i>CoP</i> -Head	Yes
d.	Modifier <sub>OUT</sub> → [Modifier <sub>IN</sub> Noun]	Head-Comp ~ Spec-Head	<i>CoP</i> -Head $\phi$ <i>CoP</i> -Comp ~ <i>CoP</i> -Spec $\phi$ <i>CoP</i> -Head	Yes
e.	Object → Verb	Spec-Head*	<i>CoP</i> -Spec $\phi$ <i>CoP</i> -Head	Yes

Table 5: The dominant GT asymmetry and cophonology-scope

Here, the trigger→target relations are repeated as in Table 4 above. These correspond to the syntactic configurations as given. Affixes correspond to heads and select a complement, while nominal modifiers either form head-comp configurations (e.g.  $D^\circ$  selecting NP) or spec-head (e.g. adjectives). In this table, I claim that objects and verbs form a spec-head configuration, which I asterisk to indicate that this is not as straightforward as the others (by default, most theoreticians assume head-comp). I will discuss this special case in section 4.4.7 below.

These syntactic configurations are mapped via hierarchy exchange, and the resulting *CoP*-scope obeys the *CoP*-scope hierarchy. Let's examine this final column with schematic examples below involving hypothetical vocabulary items.

(31) Vocabulary items and cophonology-scope:

a.	$\left. \begin{array}{l} \text{Head} \\ M: [+F] \\ F: /^{L\oplus}/ \\ P: - \\ R: \text{DOMINANT} \gg \text{DEFAULT} \end{array} \right\}$	$\phi$	$\left. \begin{array}{l} \text{Comp} \\ M: [+G] \\ F: /x/ \\ P: - \\ R: \text{DEFAULT} \end{array} \right\}$
b.	$\left. \begin{array}{l} \text{Head} \\ M: [+G] \\ F: /x/ \\ P: - \\ R: \text{DEFAULT} \end{array} \right\}$	$\phi$	$\left. \begin{array}{l} \text{Comp} \\ M: [+F] \\ F: /^{L\oplus}/ \\ P: - \\ R: \text{DOMINANT} \gg \text{DEFAULT} \end{array} \right\}$
c.	$\left. \begin{array}{l} \text{Comp} \\ M: [+F] \\ F: /^{L\oplus}/ \\ P: - \\ R: \text{DOMINANT} \gg \text{DEFAULT} \end{array} \right\}$	$\phi$	$\left. \begin{array}{l} \text{Head} \\ M: [+G] \\ F: /x/ \\ P: - \\ R: \text{DEFAULT} \end{array} \right\}$

Example a. shows two VIs which correspond to a head-comp configuration, where  $\{\text{Head}\} \phi \{\text{Comp}\}$ . For additive-dominant GT, the head must have two things: floating tones in  $F$  (where phonological material is stored) and a constraint ranking in  $R$  which favors the dominant pattern over default grammar settings. Because the head has cophonology-scope over the complement, it imposes this dominant ranking. The same reasoning and results that hold for head-comp configurations also hold for spec-head configurations.

Example b. shows cophonology-scope  $\{\text{Head}\} \phi \{\text{Comp}\}$  as well, but the head here does *not* have floating tones in  $F$  and imposes no special cophonology (indicated here as DEFAULT in  $R$ ). In contrast, the complement does have floating tones and a dominant cophonology ranking. However, because the complement does not have cophonology-scope over the head, it cannot

impose this cophonology pattern. Thus its effects will never be seen. The floating tones of the {Comp} are still able to dock to the {Head}, but will *not* show a replacive-dominant pattern, only a non-dominant one where floating tones dock to a host subject to the default phonological grammar.

Finally, example c. shows that the reverse order is not possible where {Comp} has cophonology-scope over {Head}, given the assumptions of hierarchy exchange based on asymmetrical c-command. In total, this amounts to a model with the following maxim: **outermost takes scope**. This therefore accounts for the fact that the trigger→target configurations in Table 4 rows f.-j. do *not* show dominant GT, as the requisite cophonology-scope order is not available.

Three different GT types – replacive-dominant, subtractive-dominant, and non-dominant – are shown below with their distinguishing profile with respect to floating tone and imposing a special cophonology.

(32)	<u>GT Type</u>	<u>Floating tone</u>	<u>Special cophonology</u>
a.	Replacive-dominant	Yes	Yes
b.	Subtractive-dominant	No	Yes
c.	Non-dominant	Yes	No

It is the goal of the rest of this part of this study to convince the reader of these individual theoretical points which together add up to a novel theory of both dominance effects in GT and the nature of the syntax/phonology interface.

#### 4.4.7 Objects in specifier position

Finally, an important typological result with respect to grammatical tone is that objects can impose a dominant GT pattern on verbs but not vice versa. By default, objects are assumed to be in a complement position sister to the verb and not a specifier position. However, in several places in the literature we see objects in specifier position as well. Under bare phrase structure, the distinction between complements and specifiers becomes even murkier.

However, if we place objects universally in a specifier position (or at least in a specifier position in those relevant languages), it would naturally follow that objects impose dominant GT onto verbs, because specifiers are systematically mapped to morphologically ‘outward’ positions. We can do so if we assume that all verbs consist of a categorizing head  $v^\circ$  (the head of the phrase) and a verbal root phrase  $\sqrt{P}$  (its complement, headed by  $\sqrt{\text{ROOT}}$ ), as shown in Figure 17 below.

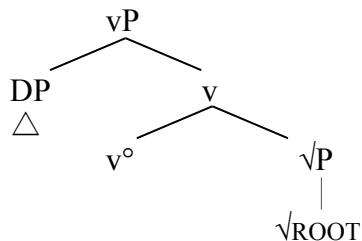

Figure 17: Object-verb structure with object in specifier position

Because the complement position of  $v^\circ$  is occupied, the only position for the object DP in this tree to appear in is in the specifier position of  $vP$  where it can c-command out and thus impose a dominant GT pattern.

Placing objects in specifier position is common practice in generative inquiry for different reasons, e.g. Larson (1988), Collins (1997), Hale & Keyser (1998), Brody's (2000a, 2000b) 'mirror theory' (discussed in Svenonius 2016), among other places. Note that all that matters is that the *final* structure show the object in a specifier position higher than the verb. Thus, if the object's initial merge position is in complement position and subsequently moves to a specifier position (also common practice, a representative recent example in Kandybowicz & Torrence 2016:229 for Krachi [kye]), then this also falls in line with our model.

#### 4.5 Transderivational correspondence: A need beyond cyclicity

We have laid out the essential technical background that I found necessary to relay in order for the reader to understand the full analysis of dominance effects with grammatical tone. To conclude our discussion for this chapter, a final crucial piece of background needs to be introduced: structuring the morpho-phonological module beyond simple cyclicity. In the next chapter, we also need access to morphologically related forms in the course of a derivation, which I will capture via **transderivational correspondence/output-output correspondence** (Benua 1997). In this way, our model follows the logic of Alderete's (1999, 2001a, 2001b) model of dominance effects which also use Output-Output Correspondence, although I differ substantially in details and thus my model is not merely a notational variant of his. This final subsection here acts as necessary background to contrast cyclic and non-cyclic approaches in phonology. Readers familiar with this contrast may turn directly to the next chapter.

Classical OT in its purest embrace of parallelism does not involve any cycles, modules, etc., but goes from syntactic substance directly to an articulatory motor plan. This state of affairs is unlikely. Let us then entertain a more reasonable proposal: within a module, there is only a single input-output mapping. We can call this the strong version of 'intra-modular non-cyclicity'. Under such a model we therefore require an alternative account of so called cyclic effects, which are numerous. One such model is Output-Output Correspondence (Benua 1997).

Let's examine a famous case in English to illustrate output-output correspondence (hereafter OO-Corr). Davis (2005) examines the oft-cited English pair with the same stress pattern <mili[t<sup>h</sup>]aristic> and <càpi[r]alistic> but different realizations of /t/. The /t/ in <militaristic> is aspirated which is the expected phonological output in pre-tonic position (e.g. Mèdi[t<sup>h</sup>]erránean, àbra[k<sup>h</sup>]adábra, Winni[p<sup>h</sup>]esáukee), and also matches the realization of /t/ in míli[t<sup>h</sup>]àry. Compare this to /t/ in <capitalistic> realized as a tap [r] rather than the expected [t<sup>h</sup>]. Davis attributes this discrepancy to an OO-Corr relationship between <capitalistic> and its morphologically related form <capital> whose /t/ is realized as a tap [r], the expected pronunciation for this position. The output forms cápi[r]al and càpi[r]alistic can be said to be in OO-Correspondence along which identity is enforced (Davis attributes this to foot structure identity ultimately).

(33) OO-Corr (schema adapted from Benua 1997)

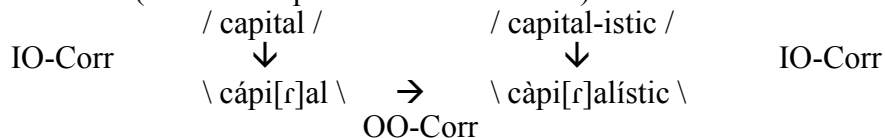

This instantiates a **paradigm uniformity effect** in which the morphologically related forms show unexpected similarity to one another which cannot be accounted for through normal phonology. This is especially challenging in those cases where the influencing form is not wholly contained within the influenced form.

Transderivational correspondence and OO-Corr can be understood as a logical conclusion of OT embrace of parallelism (taken to even more extreme measures in works like Burzio 2005). At

the same time, the topic of ‘cyclicity’ is what Kiparsky (2015) identifies as part of the ‘derivational residue’ still present in OT. The “cyclic inheritance of phonological properties from bases to derivatives” was originally “dealt with in ordered rule theory by application of rules from innermost domains outwards” (Kiparsky 2015:9), but in a strictly parallel system this is lost as well as any generalizations which it captures.<sup>21</sup>

Let’s schematize purely cyclic models versus purely parallel models lacking cyclicity. First, a purely cyclic model is in Figure 18 below.

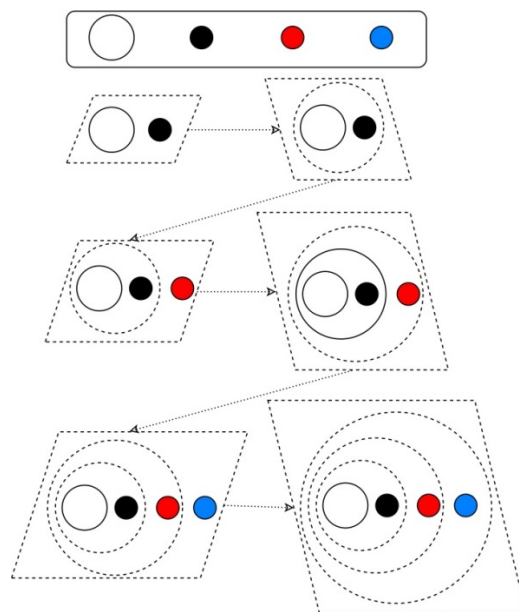

Figure 18: Purely cyclic model with extensive serialism

The circles at the top represent morphemes which are iteratively added in input-output mappings, i.e. the dotted // → \\ trapezoids. The subsequent new constituent which has been subject to phonological manipulation is the dotted circle. We see that this builds up iteratively in an inside-out fashion as the pieces are added one by one (pieces = colored circles, standing in for morphemes).

In contrast, a non-cyclic model is the figure below.

<sup>21</sup> Even unwavering critics of OO-Corr allude to a role of analogy in at least the diachrony of morphophonological patterns, e.g. “analogical change causes the new phonological process to climb up to progressively higher levels” (Bermúdez-Otero 2011:6).

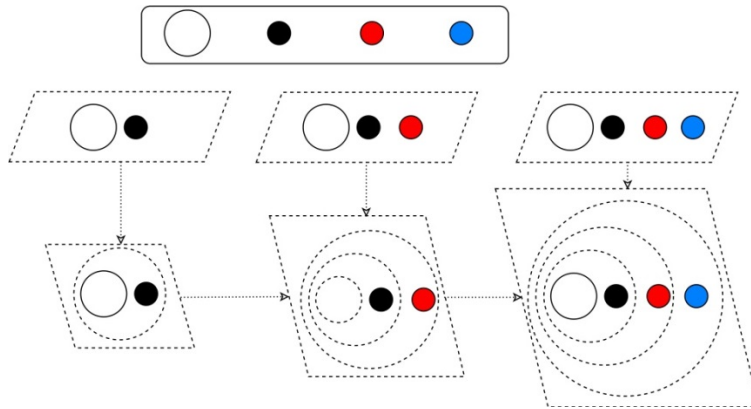

Figure 19: Purely non-cyclic model with parallelism

Here, the starting point and end point are the same as the purely cyclic model. However, there are three sets of input-output mappings which take place in parallel, each one with a different set of pieces. Each one of these outputs can influence the output which to its right via OO-Corr. This captures the ‘cyclic’ effects without cyclicity, as in no case is the output of one cycle literally the input to another cycle.

In the next chapter, I advocate for a hybrid of these two positions. Within the morpho-phonological module, cyclicity is present in as much as cophonologies apply cyclically based on hierarchical relations. However, within each cophonological cycle, there can be correspondence with the input as well as with other outputs. Although this is a more powerful model and therefore less constrained, it is justified on empirical grounds.

This hybrid structure is illustrated in Figure 20.

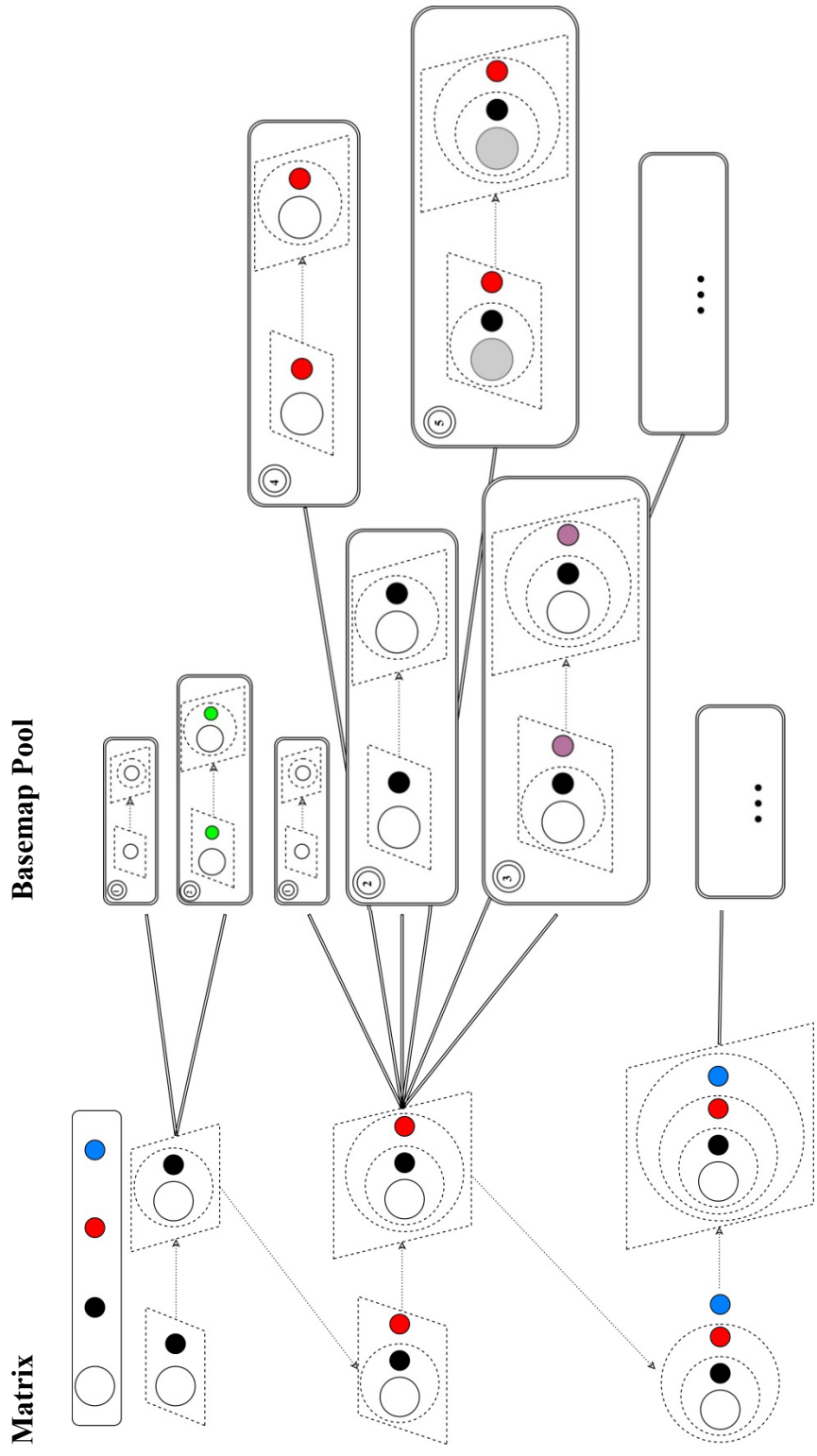

Figure 20: Hybrid cyclic model with parallelism

On the left is the **Matrix** input-output mapping which applies cyclically. This Matrix includes the contents of the morpho-phonological module, i.e. that which is fed from the morpho-syntactic module and that which feeds phonetic implementation. In short, the matrix mapping represents the normal and familiar input-output of a phonological model.

In contrast, on the right is the **Basemap Pool** which consists of parallel input-output mappings which are called **Basemaps**. The matrix mapping and a basemap overlap by at least one element (or even one sub-element like a feature). For example, the matrix mapping consisting of a white and black circle ( $\approx$  a root + affix) may correspond to a basemap consisting of only a white circle ( $\approx$  the root alone) or a white circle plus a green circle ( $\approx$  a root + different affix). These basemaps can influence the matrix mapping, depending on the cophology ranking, and thus constitute an extension of the theory of output-output correspondence. With simple concatenation, the number of potential basemaps which can be influential are small. As the size of the matrix input grows in size, however, there are more and more basemaps. How this takes place and what restricts such relations will be part of the focus of the next chapter.

To wrap up, in his comparison of OO-Corr and cyclicity models like Stratal OT, Bermúdez-Otero states that what the two theories have in common is the principle of ‘Ultimate Transparency’:

- (34) Ultimate transparency (Bermúdez-Otero 2011:11)  
If a phonological generalization  $p$  misapplies in the surface representation  $s$  of some linguistic expression, then  $p$  must apply transparently in some other representation  $r$ , with which  $s$  is in direct or indirect correspondence

In cyclic models, the string where ultimate transparency is found can be said to be *solely* a previous cycle. In contrast, with OO-Corr it can be said to be *solely* another derivation. I support the position that *both* are possible, and take there to be irrefutable evidence in fact for both. This is best summed up by Mascaró (2016):

*“The compound structures with a first component missing a base cannot be handled through OO-constraints, but they can be derived cyclically under the reasonable assumption that lexical items can lack semantic compositionality while still retaining morphosyntactic constituent structure. At the same time, however, there are analogical effects that seem difficult to derive in a stratal analysis, without OO constraints. ... In other words, some cases derive from analogic effects caused by the influence of words on words, but others derive from the way lexical representations are structured in terms of constituent structure and from cyclic effects. **Whether some unification of these two mechanisms is possible must be left for future research.**”*

[Mascaró 2016:48, bolding mine]

The next chapter is an attempt at such a unification.



## **Chapter 5**

### **Dominance as transparadigmatic uniformity via MxBM-C**

## 5.1 Overview

The previous typology established a number of distinct types of grammatical tone (GT) patterns, where I emphasized the difference between dominant and non-dominant GT. Dominant grammatical tone involves the automatic replacement of the underlying tones of a target with a new grammatical tune (replacive-dominant) or the deletion of these tones without replacement (subtractive-dominant). An example from Kalabari [ijn] is in (1) below:

(1)	Replacive-dominant GT		/ mí <sup>ⓁⓅ</sup> + _ / ‘this’ (neut.)
a.	/HH/	/ námá /	‘meat’ \ mí <b>námá</b> \
b.	/LL/	/ pùlò /	‘oil’ \ mí <b>pùló</b> \
c.	/HL/	/ bélé /	‘light’ \ mí <b>bélé</b> \
d.	/LH/	/ gàrí /	‘garri (food)’ \ mí <b>gàrí</b> \
e.	/H <sup>+</sup> H/	/ bá <sup>+</sup> rá /	‘hand’ \ mí <b>bàrá</b> \

[Kalabari - Harry & Hyman 2014:6]

Nouns contrast for underlying tone values shown at the left. However, when they appear with demonstratives (e.g. *mí* ‘this’), these underlying tones are replaced by a LH melody. This is represented in the example as floating tones /<sup>ⓁⓅ</sup>/ associated with the demonstrative in the input, and docked floating tones \<sup>ⓁⓅ</sup>\ in the output (in bold).

In contrast, non-dominant GT does not involve automatic replacement or deletion. Kalabari also illustrates this type with floating <sup>ⓅⓁ</sup> which expresses IMPERATIVE.

(2)	Non-dominant GT		/ _ + <sup>ⓅⓁ</sup> / IMPERATIVE
a.	/H/	/ só /	‘go’ \ <b>sô</b> \ ‘go!’
		/ bó /	‘come’ \ <b>bô</b> \ ‘come!’
		/ mú /	‘go’ \ <b>mû</b> \ ‘go!’
b.	/L/	/ sò /	‘cook’ \ <b>sô</b> \ ‘cook!’
		/ bè /	‘say’ \ <b>bê</b> \ ‘say (it)!’
		/ tù /	‘set’ \ <b>tû</b> \ ‘set (a trap)!’
c.	/HH/	/ ólò /	‘cough’ \ <b>ólô</b> \ ‘cough!’
		/ sába /	‘cross’ \ <b>sáâ</b> \ ‘cross!’ (= [sáwâ])
		/ kúró /	‘fall’ \ <b>kúô</b> \ ‘fall!’
d.	/LL/	/ lègì /	‘sit down’ \ <b>lègî</b> \ ‘sit down!’
		/ pìrì /	‘give’ \ <b>pîrî</b> \ ‘give (it)!’
e.	<sup>x</sup> /HL/	-	-
f.	/LH/	/ òkó /	‘tell, talk’ \ <b>òkô</b> \ ‘tell (it)!’
		/ sàkí /	‘get up’ \ <b>sàkî</b> \ ‘get up!’
g.	/H <sup>+</sup> H/	/ ó <sup>+</sup> lò /	‘hold’ \ <b>ó<sup>+</sup>lô</b> \ ‘hold (it)!’

[Kalabari – author fieldnotes]

Like nouns, verbs in Kalabari also contrast for underlying tone values shown at the left (note that there are no /HL/ verbs in row e. – Harry 2004:98). Every form of the verb in the imperative ends in a HL falling tone on the final TBU, illustrating the effect of the floating tone sequence. Unlike with the demonstrative in (1), however, the imperative does not replace the entire tone sequence and rather co-occurs with it. Lexical contrast is maintained, e.g. the minimal pair \ólò\ ‘cough!’ in (2)c. versus \ó<sup>+</sup>lô\ ‘hold (it)!’ in (2)g. Lexical contrast maintenance in fact creates super marked structures such as three tonemes docking to a single TBU e.g. L-toned /sò/ ‘cook’ → \sô\ ‘cook!’.

The central insight which I seek to formalize in this chapter is that dominant GT should be characterized as a special type of paradigm uniformity effect which I call **transparadigmatic uniformity**. I will refer to the central hypothesis I support as **dominance as transparadigmatic uniformity**. Within paradigm uniformity effects, morphologically related words are in correspondence with one another (McCarthy & Prince 1995:262), and as such can influence each other’s form in specific contexts. For example, in the dominant GT case in (1) all outputs have a uniform  $\backslash \textcircled{\text{L}} \textcircled{\text{H}} \backslash$  on the noun. This has the advantage of providing a more consistent cue for the demonstrative, but sacrifices part of the lexical contrast. In contrast with non-dominant GT in (2), outputs do not have a completely uniform form and thus maintain lexical contrast unambiguously, but at the cost of having a less demarcated cue for the imperative. This trade-off can be understood as a central tension in the realization of grammatical tone.

I capture this paradigm effect through Output-Output Correspondence (OO-Corr - Benua 1997), whereby a given output exhibits an unexpected phonological shape attributable to influence from a morphologically related output form, e.g. unexpected flapping in *capi[r]alistic* due to influence from *capi[r]al* (cf. *mili[t<sup>h</sup>]aristic* – Davis 2005). Most cases of OO-Corr involve correspondence between forms sharing the same lexical root in different morphosyntactic contexts (e.g. *capital/capitalistic*). In contrast, I claim that dominant GT demonstrates ‘transparadigmatic OO-Corr’ (Rolle 2018), which involve correspondence between different lexical roots in the same morphosyntactic context.

In my formalization, I develop a novel model which expands on the architecture of OO-Corr which I call Matrix-Basemap Correspondence (MxBM-C). Under MxBM-C, the input-output mapping being influenced is called the ‘matrix’ derivation while the input-output mapping that is exerting the influence is called the ‘basemap’ derivation (equivalent to the ‘base’ in OO-Corr literature). A basemap can be understood as a parallel input-output mapping which is computed simultaneously to the matrix derivation.

Dominant GT via Matrix-Basemap Correspondence is schematized in the figure below, using example (1)c. from Kalabari. Note the conventionalization of the matrix mapping in single slashes and the basemap mapping(s) in double slashes.

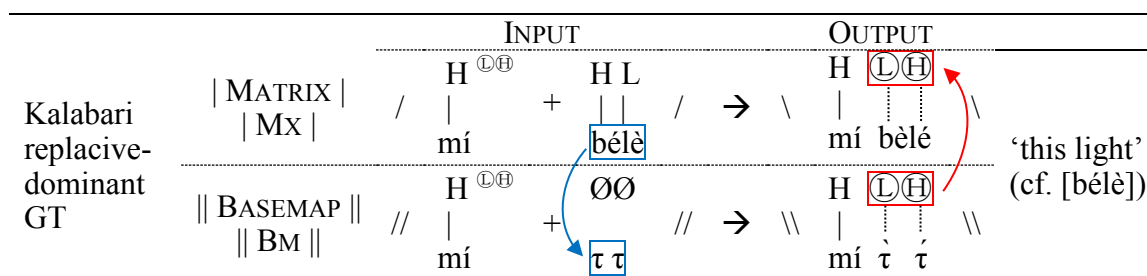

Figure 1: Replacive-dominant GT via Matrix-Basemap Correspondence (MxBM-C)

The matrix input in the top left consists of the trigger *mí* ‘this’, the grammatical tune  $\textcircled{\text{L}} \textcircled{\text{H}}$ , and the target *bé|lè* ‘light’. Dominance is the result of this trigger subcategorizing for correspondence to an abstract basemap called an ‘induced basemap’, i.e.  $//mí^{\textcircled{\text{L}} \textcircled{\text{H}}} + \tau\tau//$  (the blue arrow in the figure). This basemap is extracted based on the common structure shared by all nouns in Kalabari, which is a toneless and abstract target form  $//\tau\tau//$  (the number of TBUs is calibrated to the matrix input). Because this is toneless (unvalued), the floating tones in the basemap derivation dock to it without complication, resulting in a basemap output  $//mí \tau \tau//$ . It is to this basemap output that the matrix output must remain faithful via an OO-Corr constraint  $O_{\text{MX}}O_{\text{BM}}(\text{TONE})$ , ranked higher than any IO-IDENT or markedness constraints (the red arrow). Although the basemap input is abstract, I adopt a principle of no basemap restriction, which can be seen as an extension of Richness of the Base forbidding restrictions on inputs (Prince & Smolensky 1993:191, Smolensky 1996:3).

This model of dominance attributes the resulting pattern to faithfulness. Another approach is to attribute it to markedness, as in Inkelas (1998:139) with a constraint TONE=HL (and other similar ‘construction constraints’ in McPherson 2014). In the latter’s approach appealing to markedness constraints, it directly links dominant GT to other prominent non-concatenative ‘templatic’ morphology of the Semitic type, which similarly rank certain markedness constraints high to derive surface templates. For example, in Modern Hebrew a noun such as /telegraf/ ‘telegraph’ is converted to a verb [tilgref] ‘to telegraph’ by fitting it into a [(C)CiC(C).CeC] template. This can be captured via highly ranked markedness constraints OUTPUT=σσ and COINCIDE-i/e above faithfulness (Inkelas 1998, citing data in Bat-El 1994). I will justify my decision to model GT using faithfulness rather than markedness in the next chapter (chapter 6), where I discuss constraining the scope of morpho-phonological operations.

Furthermore, this model analyzes all grammatical tunes as floating tones, whether they be dominant or non-dominant. This is in line with ‘Generalized Non-Linear Affixation’ theory (term from Bermúdez-Otero 2012; Saba Kirchner 2010; Trommer 2011; Bye & Svenonius 2012; Trommer & Zimmermann 2014; Zimmermann 2017; Paschen 2018; a.o.), whose central premise is that non-concatenative morphology can be attributed to affixation of non-segmental material, of which floating tones are but one type. However, although dominant and non-dominant GT are *representationally* equivalent, dominant GT is crucially distinct in involving output-output constraints which enforce faithfulness to an abstract base, which goes beyond the general assumptions of Generalized Non-Linear Affixation theory.

This chapter illustrates this model of dominant GT and compares it to two additional models which have also addressed what the previous chapter called the ‘origin problem’ and the ‘erasure problem’. One is dominance as ‘Antifaithfulness’ (Alderete 2001a, 2001b) which also involves transderivational output-output correspondence, whereby a target must be *unfaithful* to a contained output form along some phonological dimension. The second are culminativity+competition based accounts such as Headmost wins (Revithiadou 1999) and diacritic weight (Vaxman 2016a, 2016b; Kushnir 2018; a.o.). I will show how both of these types suffer from fatal flaws not incurred by the model presented here.

## 5.2 Matrix-Basemap Correspondence (MxBM-C)

### 5.2.1 Output-Output Correspondence (OO-Corr)

Under traditional OT principles, there is an input form which is mapped to an optimal output form generated by GEN, as assessed from a constraint ranking from CON. The relationship between the input and the output is generally understood as input-output correspondence, where **correspondence** is defined following seminal works in McCarthy & Prince (1993, 1995):

(3) **Correspondence** (McCarthy & Prince 1995: 262)

Given two related strings  $S_1$  and  $S_2$ , correspondence is a relation  $\mathfrak{R}$  from the elements of  $S_1$  to those of  $S_2$ . Elements  $\alpha \in S_1$  and  $\beta \in S_2$  are referred to as correspondents of one another when  $\alpha \mathfrak{R} \beta$

In the most basic case, the string  $S_1$  refers to the input and  $S_2$  to the output, e.g. elements of an input string /kæt-z/ are in correspondence with counterpart elements of an output string \kæts\ (recall that I use backslashes \ to indicate an output, and reserve square brackets [ ] for surface forms). In practical OT terms, deviance in the output compared to the input constitutes violations of faithfulness (e.g. the change of /z/ to \s\ above), the counterpart being markedness which are evaluated with respect to the output only (a ban on mixed voicing with obstruents, \*TZ).

Within the history of OT, it was quickly determined that multiple different kinds of correspondence were needed (or at least justified). One prominent type which emerged was

**Transderivational Correspondence Theory (TCT)**, most prominently in Benua (1997). Under TCT, outputs are in correspondence to other outputs of morphologically related forms, exemplified below:

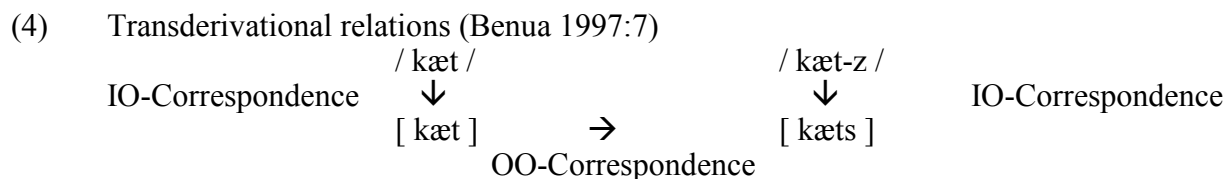

Here, there are two input-to-output correspondence relations, namely /kæt/ → [kæt] and /kæt-z/ → [kæts]. In addition, there is correspondence called **Output-Output Correspondence (or OO-Corr)** between the output forms [kæt]→[kæts] which also assesses form identity. This model is called transderivational because it involves multiple input-output derivations which are connected to one another, rather than just one derivation.<sup>1</sup>

TCT/OO-Corr is but one instance of extending the correspondence relation beyond input-output mappings. Other examples include Sympathy Theory (McCarthy 1999), where an output candidate can be in correspondence with other output candidates (the sympathetic candidate) within a single derivation, and Base-Reduplicant Correspondence (McCarthy & Prince 1995, Ussishkin 1999), where a base and a reduplicant are in correspondence within a single output candidate. Two others are Output-Variant Correspondence (Kawahara 2002) and Template-Text Correspondence (Blumenfeld 2015), the latter brought up again below.

TCT and OO-Corr were proposed largely as an alternative to the cycle in morphophonology, e.g. cycle as understood in Lexical Phonology and Morphology (LPM - Pesetsky 1979; Kiparsky 1982; Mohanan 1982, 1986; Halle & Mohanan 1985; see an overview in Rubach 2008). Under LMP, phonology and morphology are interleaved in a serial model, e.g. the famous case of English Level 1 and Level 2 affixes corresponding to distinct phonological and morphological levels.

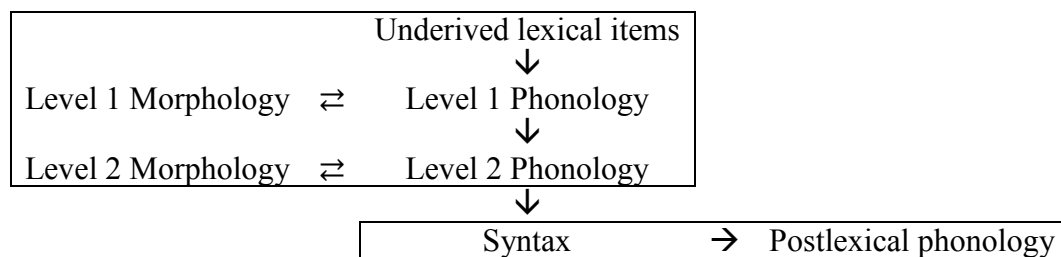

Figure 2: Lexical phonology and morphology (adapted from Kiparsky 1982)

In contrast, TCT/OO-Corr take the commitment to parallelism in OT to its logical conclusion and eliminate intermediate *morphological* levels entirely. To quote Benua,

*“One of the results of this proposal, which I dub Transderivational Correspondence Theory (TCT), is that it **eliminates intermediate stages in word formation**, and supports the strong claim of parallelism in an Optimality grammar (Prince & Smolensky, 1993). In TCT, the unit of evaluation is a paradigm, and the **paradigmatically-related words are available to the phonology at the same time**. This is a departure from the traditional analysis of over- and*

<sup>1</sup> See Rolle (2018, in press) for an extensive list of important works in TCT and OO-Corr.

underapplication patterns as the product of CYCLIC DERIVATION, in which one word is an intermediate stage in the derivation of the other.”

[Benua 1997:4, bolding mine]

In the previous chapter 4, I schematized a purely cyclic model versus a purely parallel model lacking cyclicity, figures which are repeated in Figure 3 below.

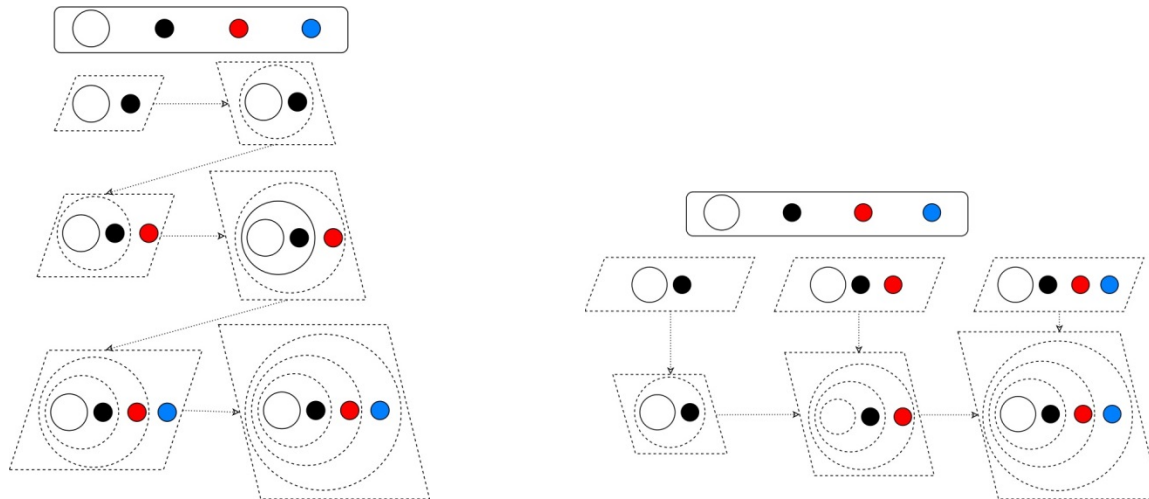

Figure 3: Purely cyclic serial model (left) vs. non-cyclic model with parallelism (right)

Let’s examine an oft-cited case in English which illustrates OO-Corr. Davis (2005) examines the English pair with the same stress pattern *mili*[t<sup>h</sup>]*aristic* and *càpi*[r]*alistic* but different realizations of /t/. The /t/ in *militaristic* is aspirated which is the expected phonological output in pre-tonic position (e.g. *Mèdi*[t<sup>h</sup>]*erránean*, *àbra*[k<sup>h</sup>]*adábra*, *Winni*[p<sup>h</sup>]*esáukee*), and also matches the realization of /t/ in *mili*[t<sup>h</sup>]*àry*. Compare this to /t/ in *capitalistic* realized as a tap [r] rather than the expected [t<sup>h</sup>]. Davis attributes this discrepancy to an OO-Corr relationship between *capitalistic* and its morphologically related form *capital* whose /t/ is realized as a tap [r], the expected pronunciation for this position. Using the schema from example (4) above from Benua, the output forms *cápi*[r]*al* and *càpi*[r]*alistic* can be said to be in OO-Correspondence along which identity is enforced (Davis ultimately attributes this to foot structure identity).

- (5) OO-Corr (schema adapted from Benua 1997)
- |         |               |         |                    |         |
|---------|---------------|---------|--------------------|---------|
| IO-Corr | / capital /   | →       | / capital-istic /  | IO-Corr |
|         | ↓             |         | ↓                  |         |
|         | \ cápi[r]al \ | →       | \ càpi[r]alistic \ |         |
|         |               | OO-Corr |                    |         |

To conclude this brief introduction, it is important to note that TCT and OO-Corr have been met with substantial criticism, e.g. in Kiparsky (2000:361), Potts & Pullum (2002:377-382), and recently throughout Kiparsky (2015) who argues that this notion is directly at odds with the core tenets of Stratal OT. A goal therefore is to construct OO-Corr in such a way so as to avoid these criticisms, which I attempt in the sections that follow. In section 5.2.4 below I revisit this

criticism examining a familiar critique against OO-Corr called the **missing base problem**, and argue that it is not actually a problem.<sup>2</sup>

### 5.2.2 From OO-Corr to MXBM-C

Example (5) above shows two outputs *capital* \cápi[r]al\ and *capitalistic* \cápi[r]alistic\ in output-output correspondence. The output form which is the influencer is *capital* normally referred to as the **base** in OO-Corr literature, and the form being influenced is *capitalistic*. I innovate distinct labels for them, building off of the foundation of terminology used in OO-Corr.

The input-output mapping being influenced is called the **matrix** input-output derivation, the shorthand for which will be MX. The mapping which is exerting an influence is called the **basemap** input-output derivation, the shorthand for which will be BM.<sup>3</sup> The **matrix input** (I<sub>MX</sub>) is what is fed from the syntax (the previous module) during spell-out. It is part of the meaning intention of the speaker and is concatenated with other parts of an utterance. That is, it is this

<sup>2</sup> Let me briefly comment on some of Kiparsky's (2015) criticism in particular, who states the following (p.10-11):

*“Transderivational constraints undermine three of OT's central goals: formalization, learnability, and a restrictive factorial typology. Tellingly, most mathematical and computational works on OT phonology ignore transderivational constraints. As far as I know there are no learnability results for them. Basic tools such as OT-Soft (Hayes, Tesar & Zuraw 2003), the Praat OT workbench (Boersma & Weenink 2007), OT-Help (Staubts et al.2010), and PyPhon (Riggle, Bane & Bowman 2011) are not very useful for them, since they assume that you can determine whether a form violates a constraint just by inspecting it...*

*The reason is that whether they are violated depends on rankings of other constraints, or on the existence of other outputs (real, potential, or fictitious, depending on the theory)... Output/Output constraints require faithfulness to the base, whose shape itself is determined by the input and the ranking of constraints including other Output/Output constraints. It is not possible to compute factorial typologies for systems that include constraints with this formally refractory property, and the standard learning algorithms cannot handle them.”*

I view such criticism as essentially boiling down to fear of a ‘House of Mirrors Pathology’. To illustrate, consider two input forms which are paradigmatically related: /tala-t/ and /tala-q/, where /tala/ is the shared root and the forms /-t/ and /-q/ are inflectional suffixes. This is shown in the schema below:

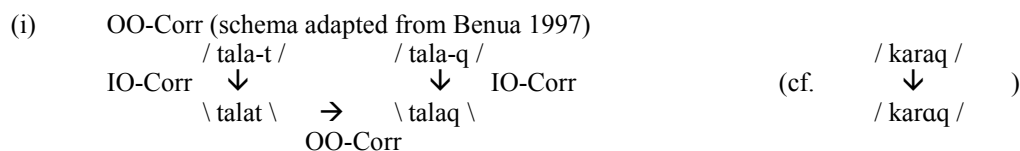

Suppose that the phonological grammar of the language enforces backing of /a/>\a\ before /q/, e.g. a hypothetical monomorphemic word \karaq\, but that this process is blocked due to paradigm uniformity. Here, this would mean that /tala-t/ → \talat\ and also /tala-q/ → \talaq\ due to influence from \talat\, rather than the expected \talaq\. A highly-ranked Ident-OO constraint would enforce identity between outputs, and thus the derivation of /tala-q/ → \talaq\ consults the output form \talat\. However, the problem is in the derivation of /tala-t/ → \talat\. By assumption, this input-output mapping would involve the same constraint set with highly-ranked Ident-OO, resulting in correspondence to the paradigmatically related output form of /tala-q/. However, this output form crucially also references the output form of /tala-t/, leading to circular co-reference in an infinite loop (hence the analogy to the ‘House of Mirrors’). Countering such criticism is beyond the scope of this study, but it is acknowledged here.

<sup>3</sup> I prefer to use the term basemap rather than base for a number of reasons. Firstly, the basemap involves an input-to-output mapping, not simply a surface output form, as I will defend below. Second, the terminology ‘base’ has multiple uses in OT, e.g. the base in Output-Output Correspondence and Base-Reduplicant theory, as well as referring to the input in a derivation, hence Richness of the Base which Benua (1997:14ff.) actually refers to as ‘Richness of the Input’ to avoid confusion.

matrix derivation which ultimately outputs the **matrix output** ( $O_{MX}$ ) to the next module, whereby abstract phonological representation is replaced by articulatory targets and a motor plan is conceived and implemented.

In contrast, the basemap can be understood as a parallel input-output derivation which is computed simultaneously in tandem with the matrix mapping. The structure of this parallel derivation involves a **basemap input** ( $I_{BM}$ ) mapped to an optimal output candidate – the **basemap output** ( $O_{BM}$ ) - which can then exert an influence on the matrix output.

Together, the two derivations are in **Matrix-Basemap Correspondence** (MxBM-C), which can be understood as an extension of Output-Output Correspondence. I illustrate MxBM-C with the capitalistic/capital pair in Tableau 1 below. Note again the conventionalization of the matrix mapping in single slashes and the basemap mapping(s) in double slashes.

<i>Matrix Input</i>	$I_{MX}$	/ ROOT –AFFIX / / capital –istic /	IDENT- $O_{MX}O_{BM}$	MARKED- NESS	IDENT- IO
<i>Matrix Output</i>	$O_{MX}$	\càpi[r]alístic \ ~ \càpi[t <sup>h</sup> ]alístic \	W (0~1)	L (1~0)	
<i>Basemap Input</i>	$I_{BM}$	// ROOT // // capital //	IDENT- $O_{MX}O_{BM}$	MARKED- NESS	IDENT- IO
<i>Basemap Output</i>	$O_{BM}$	\cápi[r]al \ ~ \cápi[t <sup>h</sup> ]al \		W (0~1)	

Tableau 1 – Illustration of MxBM-C with capitalistic/capital pair

The top part of this tableau contains the matrix derivation, in familiar OT formatting using comparative tableaux (Prince 2002, Bennett 2013). The winning output candidate is the candidate before the ~ on the left, with the losing candidate to the right. Constraints which favor the winning candidate are marked with W and the total number of violations of each candidate is below it. Constraints which favor the losing candidate are marked with L. Note that there are two sets of faithfulness constraints: IDENT- $O_{MX}O_{BM}$  assesses identity between the matrix output and the basemap output, while IDENT-IO assesses identity between the matrix input and output.

The bottom part of this tableau contains the basemap derivation. In this form, the basemap input is the ROOT //capital// which is mapped to an optimal basemap output \cápi[r]al\ with the tap rather than aspirated [t<sup>h</sup>]. This can be attributed to markedness constraints, as indicated in the tableau. Crucial to MxBM-C, the basemap is not subject to transderivational correspondence itself (i.e. the basemap itself has no basemap). Therefore both basemap candidates vacuously satisfy the IDENT- $O_{MX}O_{BM}$  constraint.

We can now illustrate MxBM-C itself. The two matrix output candidates \càpi[r]alístic\ and \càpi[t<sup>h</sup>]alístic\ are assessed as to their identity to the single winning basemap output \cápi[r]al\, which is only satisfied by the first candidate. The highly ranked IDENT- $O_{MX}O_{BM}$  favors \càpi[r]alístic\ even though it violates the lower ranked markedness constraint which favors the form with [t<sup>h</sup>]. Note that IDENT- $O_{MX}O_{BM}$  constraints are asymmetrical between the two derivations in the tableau: a violation of IDENT- $O_{MX}O_{BM}$  in the matrix derivation does *not* entail a violation of IDENT- $O_{MX}O_{BM}$  in the basemap derivation.

In most places in this study, I will provide a condensed version of MxBM-C tableaux, in which the basemap derivation is given as a smaller table at the bottom left, consisting of only the input and the winning output. This is illustrated in Tableau 2 below. Such a representation will be useful when we see instances of MxBM-C with multiple basemap derivations in correspondence with a matrix derivation.



I <sub>Mx</sub>	/ (ROOT –AFFIX) / / (capital –istic) /	IDENT-O <sub>Mx</sub> O <sub>Bm</sub>	MARKEDNESS	IDENT-IO
O <sub>Mx</sub>	\ càpi[r]alistic \ ~ \ càpi[tʰ]alistic \	W (0~1)	L (1~0)	

I <sub>Bm</sub>	// ROOT // // capital //
O <sub>Bm</sub>	\\ càpi[r]al \\

Tableau 2 – Condensed version of MxBM-C (corresponding to full version in Tableau 1)

Matrix-Base-map Correspondence can be understood as embodying the insight behind Benua’s ‘recursive evaluation’ (Benua 1997:33). This states that “words in a phonological paradigm are evaluated in parallel against a recursive constraint hierarchy”, such that the most deeply embedded morphological constituent is ‘morphologically prior’ in the relevant sense. Essentially this takes the cycles within a serial model and places them side by side in a hierarchy (refer to the diagram at the end of chapter 4). Consider the following recursive tableau involving two derivations (Benua 1997:34): the input-output mapping of the name *Larry* /læri/, and its truncated form *Lar* /læri-TRUNC/ > \lær\. This truncated form is noteworthy because in those dialects of English which have maintained the *Merry/Mary/Marry* distinction, the surface form [lær] violates a constraint against æ before r (\*ær]<sub>σ</sub>).

Recursive evaluation runs two derivations in parallel, generating a list of candidates. These output candidates are paired in the different evaluations.

- (6) Recursive evaluation – Paired output candidates (Benua 1997:34)
- |    |                 |          |       |                                |
|----|-----------------|----------|-------|--------------------------------|
| a. | candidate (a)   | L[a]rriy | L[a]r | <i>overapplication</i>         |
| b. | candidate (b)   | L[a]rriy | L[æ]r | <i>"backwards" application</i> |
| c. | candidate (c)   | L[æ]rriy | L[a]r | <i>normal application</i>      |
| d. | ☞ candidate (d) | L[æ]rriy | L[æ]r | <i>underapplication</i>        |

In recursive evaluation, candidates in the base – recursion (A) to the left – are assessed first and an optimal candidate is chosen. A highly ranked output-output constraint OO-ID in the derivative form – recursion (B) to the right – then enforces identity to this winning base candidate, even though it violates the lower-ranked markedness and IO-faithfulness constraints.

Base - recursion (A)				Derivative - recursion (B)				
/ læri /	OO-ID	*ær] <sub>σ</sub>	IO-ID	»	/ læri -TRUNC /	OO-ID	*ær] <sub>σ</sub>	IO-ID
a. \ lari \			*!		a'. \ lar \			*
b. \ lari \			*!		b'. \ lær \	*	*	
c. \ læri \					c'. \ lar \	*!		*
d. ☞ \ læri \					d'. ☞ \ lær \		*	

Tableau 3: Recursive evaluation (Ranking: OO-IDENT[BK] » \*ær]<sub>σ</sub> » IO-IDENT[BK] )

The most important aspects of recursive evaluation are (i) the base has priority and is ‘run first’ so to speak, (ii) the OO-ID constraint is asymmetric in that violations are only assessed in the derivative form, and (iii) this is *not* a serial model, in line with a strong version of parallelism within OT.

The idea of running parallel derivations even at speech time is supported by Braver (2013) in an articulated model of the phonology-phonetics interface. He adopts Benua’s notion of recursive evaluation:

*“I assume that at the speech time, the speaker first determines which underlying form should serve as the base, then **applies the language’s canonical phonology and phonetics to that form**. At this point, the candidate is **evaluated with respect to this freshly-minted base**. This view has the benefit of neatly accounting for paradigm uniformity effects in nonce words: given a nonce word for which the speaker can work out an underlying representation, the speaker need only apply the language’s canonical phonology and phonetics to this form, and evaluate the nonce candidate with respect to the generated base”*

[Braver 2013:121, bolding mine]

The first bold sequence states that the base (our ‘basemap’) is subject to the application of phonological/phonetic constraints at that stage of the derivation, which I take to be a standard input-output mapping. An output candidate (our ‘matrix output’) is then evaluated against this new base (our ‘basemap output’), in addition to ‘regular’ phonology and phonetics. The important take away here is that multiple derivations are run simultaneously in an asymmetrical relation: the base serves as a target which a candidate strives to meet, a major insight of Braver.

### 5.2.3 Types of transderivational uniformity effects

At this point, data such as *capitalistic/capital* are equally compatible with a purely cyclic model with no transderivational influence (as advocated prominently in Stratal OT – Kiparsky 2015, a.o.). This is because of the **OO containment criterion** assumed in most (early) work on OO-Corr which states that bases must be entirely contained within derivatives (see discussion in Bermúdez-Otero 2011:13).

Not all types of MxBM-C obey this criterion. In previous work (Rolle 2018), I typologized the different types of transderivational uniformity effects highlighting three types: **classic OO-Corr**, **paradigmatic OO-Corr**, and **transparadigmatic OO-Corr** (in the terminology of this study, ‘OO-Corr’ would be replaced by ‘MxBM-C’). These types are summarized below.

(7)	<u>Type of OO-Corr</u>	<u>Matrix</u>		<u>Basemap</u>
a.	Classic	X-Y e.g. [ROOT]-AFX	↔	X ROOT
b.	Paradigmatic	X-Y <sub>[+F]</sub> e.g. [ROOT]-AFX <sub>1[+F]</sub>	↔	X-Z <sub>[+F]</sub> [ROOT]-AFX <sub>2[+F]</sub>
c.	Transparadigmatic (stem)	X-Z-Y e.g. [ROOT-AFX <sub>2</sub> ]-AFX <sub>1</sub>	↔	X-Y [ROOT]-AFX <sub>1</sub>
d.	Transparadigmatic (root)	W-Y e.g. [ROOT <sub>1</sub> ]-AFX <sub>1</sub>	↔	X-Y [ROOT <sub>2</sub> ]-AFX <sub>1</sub>

The *capitalistic/capital* pair is an example of classic OO-Corr in which the basemap output (the root) is a subconstituent entirely contained within the matrix output, equivalent to the morphological stem.

In contrast, the latter types are not handled well in a purely cyclic model without transderivational correspondence, and thus differentiate the models. Under paradigmatic OO-Corr, outputs share a root and the affixes Y and Z share a morpho-syntactic feature [+F], which thereby places them together in a paradigm, e.g. a standard verb inflection paradigm (Kenstowicz 1996; papers throughout Downing et al. 2005; Steriade 2012; a.o.). For example, consider the

following cases from dialectal German in which the matrix output and base outputs are in correspondence by virtue of being in the same inflectional paradigm (Hall & Scott 2007). In several German dialects, /s/ becomes [ʃ] before {t/p}, a process dubbed ‘s-dissimilation’ (e.g. <post> ‘mail’ rendered [poʃt]). Hall & Scott (2007:173) illustrate that in Falkenberg German, s-dissimilation is blocked and underapplies in certain morphological paradigms. One such context of underapplication is the third singular inflected form of the verb <essen> ‘eat’, which surfaces as [ɛs-t] rather than the expected <sup>x</sup>[ɛʃ-t], shown below.

(8) Paradigmatic OO-Corr in Falkenberg German

[+INFL]:	INFINITIVE	1SG	2SG	3SG	IMP.SG	PST.PART
Form:	[ɛs-ən]	[ɛs-ən]	[ɛ-ʃt]	[ɛs-t] ( <sup>x</sup> [ɛʃ-t] )	[ɛs]	[gəsas]

Hall & Scott attribute this to an identity relation with morphologically related words in its paradigm, e.g. the INFINITIVE, 1SG, and IMP.SG forms whose root shape is [ɛs]. In our terms, these forms constitute the basemaps for the matrix input, the 3SG. Crucially, all morphological features of the basemaps are *not* found in the matrix. Similar cases and arguments abound throughout Downing et al.’s (2005) volume on paradigm uniformity effects, and the extended case study of correspondence between Latin perfects in Steriade (2012). There are even cases where the matrix form has been claimed to be a proper subconstituent of the *basemap* form – the inverse situation from what would be expected – e.g. in Braver’s (2013) analysis of Japanese sub-minimal words with short vowels.

Rolle (2018) highlights another type termed transparadigmatic OO-Corr (Tr-OO-C), with important predecessors Burzio (1998) and Pariente (2012). This comes in two subtypes. In (7) row c., the outputs share the same root as well as the same outer morphology (i.e. AFX<sub>1</sub>), but have distinct stems: the matrix output has different inner morphology by virtue of having an additional affix, while the basemap output does not. Thus, the basemap output is not a contiguous constituent of the matrix output. One example of transparadigmatic OO-Corr having the same root but a different stem is overapplication of /l/-to-[i]-vocalization in Brazilian Portuguese (Rainer 1996; Benua 1997:237-240; Bachrach & Nevins 2008), shown below.

(9) Tr-OO-C in overapplication of Brazilian Portuguese /l/-to-[i]-vocalization

Ø	-s PL	-zinho DIM	-zinho DIM + -s PL
<i>jornal</i>	<i>jorna[i]-s</i>	<i>jornal-zinho</i>	<i>jorna[i]-zinho-s</i>

Here, the /l/ in *jornal* ‘newspaper’ becomes [i] in plural *jorna[i]s* before [s] by regular phonology. This root may appear with the diminutive derivational morph *-zinho*, resulting in *jornalzinho* where /l/→[i] does *not* occur by regular phonology. When this derivational form appears with inflectional *-s*, however, *l*-vocalization overapplies in the resulting *jorna[i]zinhos*, even though /l/ is not before [s]. Schematically, this is a case where the matrix output is [ROOT-DERIV]-INFL and the basemap output is [ROOT]-INFL, with output-to-output correspondence mediating identity in the shape of the root.

A rubik’s cube is a useful metaphor for distinguishing paradigmatic and transparadigmatic OO-Corr, shown in the figure below.

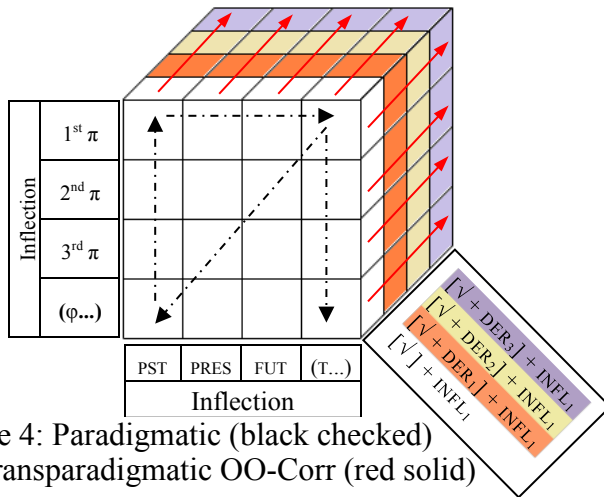

Figure 4: Paradigmatic (black checked) vs. Transparadigmatic OO-Corr (red solid)

Under paradigmatic OO-Corr, there is correspondence *among* cells within the *same* paradigm, by virtue of their morphology sharing some feature [+F] (here denoted as inflectional features for person and tense). In the figure, a paradigm is signaled by having the same color, and potential cells in paradigmatic correspondence are connected by the checked black arrows. In contrast, under transparadigmatic OO-Corr there is correspondence *across* counterpart cells in *equivalent* paradigms, e.g. by virtue of sharing the exact same inflectional morphology. Potential cells in transparadigmatic correspondence are connected by the solid red arrows.

The other subtype of transparadigmatic OO-Corr is in (7)d., in which outputs only share the same outer morphology (i.e.  $AFX_1$ ) but have different roots. This is equivalent to Pariente’s (2012) ‘Grammatical Paradigm Uniformity’ which develops a formal correspondence model “between words sharing a Morphological Structure, but not sharing a lexeme”. It is this type of OO-Corr which I analyze dominance effects as, i.e. dominance as transparadigmatic uniformity.

#### 5.2.4 What is a possible basemap?

Before laying out the details of dominance as transparadigmatic uniformity, there is a final issue to address: what is a possible basemap? In this subsection, I first lay out the traditional criteria for restricting possible basemaps, and then argue against them. In contrast to these traditional criteria, I adopt a more liberal position: there are no restrictions on possible basemaps. I call this proposal the ‘principle of no basemap restriction’.

##### 5.2.4.1 Traditional criteria for restricting possible basemaps

To begin, in the literature there are four intersecting criteria which are often overtly or tacitly assumed in the presentation of OO-Corr/TCT. This is true both in works arguing for and against OO-Corr. I cull these from various sources, as not all practitioners or commenters agree on exact criteria.

The first is a containment criterion, which I refer to as the **OO containment criterion** to differentiate the use of the term ‘containment’ elsewhere, e.g. ‘colored containment’ (van Oostendorp 2006, Revithiadou 2007, Trommer 2011). This is summed up as in Kager (1999):

- (10) OO containment criterion (based on Kager 1999:281-282):  
*“the base is compositionally related to its derived counterpart.... That is, the base contains a proper subset of the grammatical (semantic, morphological) features of the derived form”*

In practice, this is taken to state that the base must be a constituent of the derivative. As stated above, classic OO-Corr such as the *capitalistic/capital* pair adhere to this conservative definition, as the base (= basemap) is a proper subset of the derivative (= matrix).

A second is the **independence criterion**, which assumes that the base must have the ability to appear independently as a ‘surface form’. Like the OO containment criterion, this was assumed in early work on OO-Corr (Benua 1997) and is still commonly assumed (Bermúdez-Otero 2011):

*“Pairs of **surface forms** are linked by a transderivational or output-to-output (OO) correspondence relation.”*

[Benua 1997:vi, bolding mine]

*“denominal verbs are formed from bases that already exist as **independent words** (typically nouns) in the language.”*

[Ussishkin 1999:403 discussing Modern Hebrew, bolding mine]

*“morphosyntactically induced misapplication arises when high-ranking OO-identity constraints cause a transparently derived **surface property** of a given expression (**the ‘surface base’**) to be transmitted to the **surface representation** of some morphosyntactically related expression, where its presence is opaque.”*

[Bermúdez-Otero 2011:10, bolding mine]

This fact is often taken as a fatal flaw of OO-Corr. For example, Mascaró (2016:47) compares OO-Corr to Stratal OT stating “a stratal analysis does not rely on the existence of **an independent word**” (bolding mine). Implicit in this debate is the OO-Corr assumption that the output of phonology is equivalent to the ‘surface form’ actually encountered by speakers, which is the strictest possible version of parallelism in OT, containing no intermediate forms at any level.

A third is the **lexical criterion** which states that bases can only be ‘words’: “phonological derivation optimizes *words* (or pairs of words), and not any other unit” (Benua 1997:240, italics hers). Kager (2000:136) explicitly rejects constituents above the word, e.g. his discussion of verb-particle constructions in Dutch:

*“the **phrasal nature** of the stress pattern of separable verbs renders it ‘invisible’ to the [OO-C constraint] PK-MAX, which accesses **lexical prosodic units only**”.*

[Kager 2000:136, bolding mine]

Finally, and relatedly, is the **existential criterion** which states that bases have to be ‘real’ words. For example, Steriade (1999) accounts for differences in the stress with *-able* derivatives based on the inventory of their related words.

(11)	Derivative	Base 1	Base 2
	a. remédiable	rémedy	remédial
	b. párodiable	párody	*paródial

The form remédiable has an existent base remédial which it can refer to, while párodiable only has a base párody. No form paródial exists, and therefore it cannot be a base.

These four criteria are listed below (which I will argue against):

- (12) Traditional criteria for restricting bases in OO-Corr (to be argued against)
- OO containment criterion – be a constituent of the derivative (i.e. of the matrix output)
  - Independence criterion – be an independent surface form
  - Lexical criterion – be a word
  - Existential criterion – be a real word

In either explicitly or implicitly assuming these criteria, the most common criticism levelled against OO-Corr (and by extension MxBM-C) is the **missing base problem** (Mascaró 2016). This has been recapitulated several times in the last two decades in the literature (e.g. Kiparsky 2000; Bobaljik 2008:48; Bermúdez-Otero 2011; Trommer 2013; Gouskova & Linzen 2015:450; Mascaró 2016; Bennett 2018; Kastner 2018).

The argument against OO-Corr from the missing base problem is as follows. Assuming that bases are independently occurring real words, we predict that there will be no transderivational effects when the base is unavailable, being unavailable either because it doesn't exist or because it cannot be selected in the specific situation. In such cases, the base is said to be 'missing'. If faithfulness is parasitic on correspondence to a morphosyntactically related form, then satisfying any faithfulness imperative should be rendered moot when such a form is absent (i.e. no faithfulness to a missing base). In these cases we would expect 'default' faithfulness or markedness constraints to be active instead. However, in nearly all cases identified in the literature, the transderivational identity effects persist despite the base being missing, which is unexpected.

To exemplify, consider stress with *pluralia tantum* in Albanian (Trommer 2013). Stress in uninflected Albanian nouns falls on the ultima if the syllable is heavy and does not contain /ə/ (<ë>), or if it is light and contains /i u a/. Otherwise it appears on the penultimate. This position of stress is maintained in plural forms regardless of the content of its syllable, shown with the regular noun *patok* 'gander' in the leftmost columns below.

Regular noun: <i>patok</i> 'gander'			Pluralia tantum: <i>pemurina</i> 'fruit'		
a.	Singular	Plural	b.	Singular	Plural -a
Indefinite	NOM	/patok/ [pa.'tok]	/patok-ë/ [pa.'to.kë]	NOM	- /pemurin-a/ [pe.mu.'ri.na]
	ACC	/patok/ [pa.'tok]	/patok-ë/ [pa.'to.kë]	ACC	- /pemurin-a/ [pe.mu.'ri.na]
	DAT	/patok-u/ [pa.'to.ku]	/patok-ëve/ [pa.'to.kë.ve]	DAT	- /pemurin-a-ve/ [pe.mu.'ri.na.ve]
	ABL	/patok-u/ [pa.'to.ku]	/patok-ësh/ [pa.'to.kësh]	ABL	- /pemurin-a-sh/ [pe.mu.'ri.nash]
Definite	NOM	/patok-u/ [pa.'to.ku]	/patok-ët/ [pa.'to.kët]	NOM	- /pemurin-a-t/ [pe.mu.'ri.nat]
	ACC	/patok-un/ [pa.'to.kun]	/patok-ët/ [pa.'to.kët]	ACC	- /pemurin-a-t/ [pe.mu.'ri.nat]
	DAT	/patok-ut/ [pa.'to.kut]	/patok-ëve(t)/ [pa.'to.kë.ve(t)]	DAT	- /pemurin-a-ve(t)/ [pe.mu.'ri.na.ve(t)]
	ABL	/patok-u/ [pa.'to.ku]	/patok-ëve(t)/ [pa.'to.kë.ve(t)]	ABL	- /pemurin-a-ve(t)/ [pe.mu.'ri.na.ve(t)]

Table 1: Albanian stress uniformity in regular nouns and *pluralia tantum* without a base (Trommer 2013:116,131)

With regular nouns, the dative singular indefinite form of the root is /patok-u/ [pa.'to.ku]. This retains the position of stress from the nominative form /patok/ [pa.'tok]. To see how this is opaque, consider non-inflected forms where stress is attracted to the final [u], e.g. final stress in [ash.'tu] ‘this way’. Thus, stress is determined phonologically in *uninflected* forms, but morphologically in *inflected* forms. In OO-Corr terms, plural [pa.'to.ku] would be in correspondence with singular [pa.'tok], which is the base which influences it.

Problematic for OO-Corr are *pluralia tantum* in the rightmost columns. The word *pemurina* ‘fruit’ is only found in its plural form, as indicated by its suffix /-a/. It does not occur in the singular and therefore the relevant base is missing. Regardless, the plural form maintains consistent stress on the root syllable <ri> as if it were in correspondence to the (non-existent) output form <sup>x</sup>/pemurin/ <sup>x</sup>[pa.mu.'rin] ‘fruit (sg)’ (note <sup>x</sup> = non-existent/not attested). Because the inherently plural form does not have an existent singular base, we would expect stress to fall on the final syllable as it does in the monomorphemic [ri.'xha] ‘prayer’. This is contrary to fact, which Trommer interprets as undermining the predictions of OO-Corr.

#### 5.2.4.2 Arguments against the traditional criteria for restricting possible basemaps

Unlike the literature discussed above, I do not accept the premise that these should be the criteria restricting possible basemaps. The first argument I make is against the ‘OO containment criterion’, which assumes a conservative position that the basemap output be constituent of the matrix output. Firstly, practitioners modeling paradigmatic effects with OO-Corr as a whole do not adopt this criterion (e.g. Steriade 2012, a.o.). For example in the German case in (8) above, the basemaps would include the INFINITIVE, 1SG, and IMP.SG forms whose root shape is [es], all of which contain features and phonological material that would not be present in the matrix.

Similar cases and arguments abound throughout Downing et al.’s (2005) volume on paradigm uniformity effects, as well as the extended case study of correspondence between Latin perfects in Steriade (2012). There are even cases where the matrix form is claimed to be a proper subconstituent of the *basemap* form – the inverse situation from what would be expected – e.g. in Braver’s (2013) analysis of Japanese sub-minimal words with short vowels. Even amongst those supporting a pure cyclic model involving strict iterative input-output mapping admit to the problem of paradigmatic effects, e.g. Mascaró’s (2016) study of prefixed and compounded nouns with ‘missing bases’ in Central Catalan:

*“The compound structures with a first component missing a base cannot be handled through OO-constraints, but they can be derived cyclically under the reasonable assumption that lexical items can lack semantic compositionality while still retaining morphosyntactic constituent structure. At the same time, however, there are analogical effects that seem difficult to derive in a stratal analysis, without OO constraints. ... In other words, some cases derive from analogic effects caused by the influence of words on words, but others derive from the way lexical representations are structured in terms of constituent structure and from cyclic effects.”*

[Mascaró 2016:48, bolding mine]

It is not an accident that the strongest version of stratal OT does not have a straightforward mechanism for such effects.

Moreover, although it is often claimed that the base must be a word (the lexical criterion), there is little theory-internal requirement for this position. I view this assumption as a holdover from Lexicalist theories which gives privileged status to the notion ‘word’ (Halle 1973, Aronoff 1976, Pesetsky 1979, Mohanan 1982, Kiparsky 1982; see Siddiqi 2014 for a thorough and balanced survey). The main features of Lexicalist theories are (i) there is a separate morphological module which creates words (e.g. a generative lexicon) and (ii) this

morphological module feeds a syntactic module which strictly creates phrases. In such a theory, the constituent ‘word’ is conceptually precise (albeit difficult to empirically diagnose), and therefore can be readily imported into OO-Corr models which state that only words created by this separate module can be bases, and not anything ‘smaller’ or ‘larger’ than it.

Lexicalism has been attacked from many sides, with one of the biggest opponents being Lieber (1992) followed by Distributed Morphology (Halle & Marantz 1993, Marantz 1997) which is the theory adopted in this study. Arguments against Lexicalism have been conceptual (why have two generative modules when you can have one), as well as empirical (there are no qualitative differences between morphology and syntax, e.g. idiomatic meaning); again, see Siddiqi (2014) for discussion. The most important point from these works is that syntax generates all structure, which then feeds morphophonology.

The specific instantiation of TCT supported here - Matrix-Basemap Correspondence – is understood as tapping into a general correspondence mechanism which connect two linguistic constituents of sufficient similarity and enforce identity between them. Constituency can be at different levels both morphosyntactically (e.g. XP vs. X<sup>o</sup>) and prosodically (e.g. φ vs. ω vs. μ), and putting *a priori* restrictions on which ones enter transderivational relations is unjustified. Within an anti-Lexicalist model (such as the one supported here), the idea that a base must be of the constituent type ‘word’ is contentious at best, if not rendered meaningless.

Moreover, as stated above many discussants of OO-Corr point to bases being ‘surface forms’ (the independence criterion). Recall the quote from Benua (1997:vi): “pairs of surface forms are linked by a transderivational or output-to-output (OO) correspondence relation”. In practice, however, what constitutes the ‘surface form’ is not made explicit. In a literal interpretation, this would mean the phonetic product that is the end result of a derivation, e.g. a pronunciation of /capital/ as [kʰæpɪtɹ]. Identity involving phonetic representation is in fact argued for explicitly in Steriade (2000) and Braver (2013). Braver argues that incomplete neutralization in Japanese between short and long vowels when spoken in isolation “is best modeled as a compromise between faithfulness to a morphologically-related base form and pressure to hit phonetic targets” (p. 27), using a constraint OO-ID-DUR which penalizes candidates for vowel durations which differ from its morphologically-related base<sup>4</sup>.

However, in the majority of cases the identity relation is between *phonological* properties not surface phonetic properties, e.g. phonological foot structure in the capitalistic/capital case (which ultimately licenses a phonetic effect, flapping of /t/). I find that there is no reason to commit transderivational theory to only one type of output, especially in the model assumed here involving modularity and intra-module cyclicity (as laid out in chapter 4). The question of how many outputs there are – ultimately a question of how many cycles (strata/levels/modules/etc.) – is orthogonal to the mechanics of OO-Corr and the present instantiation as MxBM-C.

Another argument is against the existential criterion (i.e. be a real word). Maintaining this criterion implies storing all outputs and accessing them when Output-Output Correspondence is enforced. This assumption is untenable, as memorizing all outputs is contrary to the entire function of a generative grammar. By producing complex forms online, this eliminates the burden of needing to memorize such complex outputs; it is more economical to generate them

<sup>4</sup> In short, Japanese requires that all Prosodic Words have at least two moras (Itô 1990, Poser 1990, Braver 2013:3). Braver demonstrates that despite phonological ‘neutralization’, phonetic differences persist (squared):

Underlying form	Input	Output	Phonetic form	Approximate duration
/kii/ ‘key’	/kii/ →	\(ω ki <sub>μ</sub> i <sub>μ</sub> ) \ →	[kii] <sub>1</sub>	<b>150 ms.</b>
/ki/ ‘tree’	/ki/ →	\(ω ki <sub>μ</sub> i <sub>μ</sub> ) \ →	[kii] <sub>2</sub>	<b>125 ms.</b>
/ki mo/ ‘tree PART’	/ki mo/ →	\(ω ki <sub>μ</sub> mo <sub>μ</sub> ) \ →	[ki] <sub>3</sub>	50 ms.



from smaller, stored primitives (the lexicon/vocabulary), which are subject to the system of combinatorics (the generative grammar).

As stated above, I see this too as a holdover from Lexicalism, for example the argument which accounts for morphological blocking from Kiparsky (glory vs. \*gloriosity) that the lexicon stores outputs but not if the result would be storing two synonyms (discussion in Siddiqi 2014:353,358). However, this assumption simply fails on two grounds, the first concerns agglutinative/polysynthetic languages with a high degree of morphology. The number of unique forms in such languages is significantly higher than in more analytic languages. One popular figure is David Odden's calculation for the Bantu language Shona (Karanga dialect) [sna] that each verb has at least 16 trillion forms when all inflectional and derivational morphology is taken into account (Odden 1981:17, cited by Albright 2002, Marlo 2013, a.o.), an impossible burden to place on speakers/learners.

Secondly, memorizing all forms without a generative component within OO-Corr is incompatible with nonce words effects, which illustrate its productivity. This is made explicit in Braver's (2013) discussion:

*“No knowledge of word-specific frequency is needed to generate the base, as type frequency is computed over the entire inflectional paradigm of the candidate (e.g., all nouns, all verbs, etc.). Under a theory of basehood in which the phonetic detail of a base is pre-generated, nonce words are predicted to fail, since the base will not be available at the time of evaluation. This is counter to the evidence speakers are able to produce incompletely neutralized forms, which implies faithfulness to a base.”*

[Braver 2013:121-122]

In short, there is no doubt that complex forms can be stored, usually attributed to two factors: high frequency and/or idiomatic meaning. However, storing *all* forms comes at too high of a cost.

Finally, if TCT and Matrix-Basemap Correspondence involve parallel input-output mappings of the same type, then both should be subject to the OT assumption of **Richness of the Base (ROTB)**. Essentially, this states that there are no language-specific restrictions on the input:

*‘This principle was proposed in Prince and Smolensky 1993:191; the formulation I adopt here is given in (1). (1) Richness of the Base. The source of all systematic cross-linguistic variation is constraint reranking. In particular, the set of inputs to the grammars of all languages is the same. The grammatical inventories of a language are the outputs which emerge from the grammar when it is fed the universal set of all possible inputs.’*

[Smolensky 1996:3]

It would therefore be quite striking if there were restrictions on the inputs of basemaps – in violation of ROTB – but not otherwise on the matrix derivation.

In light of these arguments against the traditional criteria restricting possible basemaps, I propose the following principle:

[Def 1] **Principle of No Basemap Restriction** – There are no restrictions placed on linguistic form of the basemap input

In this way, this principle mirrors that of ROTB.<sup>5</sup>

Returning to the ‘missing base problem’, overall I do not consider this to be an actual problem, as I do not accept the criteria on which it is based. Instead, I take it as illustrating the need for two things: (i) the need for cyclicity within the phonological module and (ii) the need to derive basemaps from somewhere other than the lexicon (~ linguistic memory). These constitute the focus of the rest of this chapter, with grammatical tone as its case study.

### 5.3 Dominant GT via MxBM-C

#### 5.3.1 Selection of a basemap

Compared to discussion of how basemaps/bases are restricted within OO-Corr, less attention has been paid to how basemaps are *selected* within the course of a derivation: within a range of possible basemaps, how is one or more chosen to the exclusion of others? In most cases, the base simply exists in the derivation without formalizing how it gets there. Of those who have discussed base selection, one idea is that it crucially relies on token frequency (Stanton & Steriade 2014) or type frequency (Steriade 2012, Braver 2013). Another is that the base is maximally informative relative to other potential bases (Albright 2002):

*“The second hypothesis is that learners select the base form that is maximally informative, in the sense that it preserves the most contrasts, and permits accurate productive generation of as many forms of as many words as possible.”*

[Albright 2002:ix]

Although both of these approaches are extremely profitable to understanding to OO-Corr and TCT generally, neither can easily be incorporated into a derivational constraint-based model of grammar: both are meta-grammatical in the sense that they refer to information about the grammatical system as a whole.

This subsection will present a model for how basemaps are selected. In order to do this, we must recap some of the discussion of vocabulary items discussed in the previous chapter. Recall the content for all vocabulary items (VIs) adapted from Sande & Jenks (2017):

- (13) Content of vocabulary items (VIs)
- a. **VI label**: Unique name of the VI (for identificational purposes only)
  - b. **Morphosyntactic content (*M*)**: Morphological features (paired to SynSem features in the syntax)
  - c. **Featural content (*F*)**: Tonal or segmental content
  - d. **Prosodic content (*P*)**: Prosodic selection or subcategorization
  - e. **A constraint subranking (*R*)**: A partial constraint ranking, which overrides a default master constraint ranking

This includes four major components: morphological features (*M*), phonological features (*F*), prosodic subcategorization (*P*), and a constraint subranking which overrides a default master ranking (*R*). All of these components play a role in morphophonological exponence which takes place at spell-out.

---

<sup>5</sup> It would not be unfounded to call this ‘Richness of the Basemap’, but I predict such a term would be confused with traditional ROTB.

To exemplify with real data, consider the Turkish case where some affixes trigger glide-insertion to repair vowel hiatus such as /-uundʒa/ ADVERBIAL in (14)a, while other affixes trigger vowel deletion such as /-ujor/ PROGRESSIVE in (14)b.

(14) Affixes with distinct rankings

- a. Insertion  
 /anla-ma-**uundʒa**/ [anlam**aj**uundʒa]  
 ‘understand-NEG-ADV’ \*VV » MAX-V » DEP-C
- b. Deletion  
 /anla-ma-**ujor**/ [anlam**u**jor]  
 ‘understand-NEG-PROG’ \*VV » DEP-C » MAX-V

[Turkish – Inkelas & Zoll 2007:137]

The former suffix is associated with a cophonology with a constraint ranking \*VV » MAX-V » DEP-C favoring insertion, while the latter with \*VV » DEP-C » MAX-V favoring deletion. Therefore, within the constraint subranking (*R*) is a partial constraint ranking which overrides a default master constraint ranking. The VIs for the two Turkish suffixes are below.

(15) Turkish VIs with distinct cophonologies

$\left\{ \begin{array}{l} \underline{\text{Progressive}} \\ M: [+PROG] \\ F: /-ujor/ \\ P: - \\ R: *VV \gg \text{DEP-C} \gg \text{MAX-V} \end{array} \right\}$	vs.	$\left\{ \begin{array}{l} \underline{\text{Adverbial}} \\ M: [ADV] \\ F: /-uundʒa/ \\ P: - \\ R: *VV \gg \text{MAX-V} \gg \text{DEP-C} \end{array} \right\}$
--	-----	--

A core analytic move of my proposal is that triggers of dominance (such as dominant GT triggers) contain a highly ranked MXBM-C constraint which enforces faithfulness to a basemap, resulting in output-output correspondence. For example, in the Kalabari case of replacive-dominant GT in (1) above, the trigger *mí* ‘this’ has a highly ranked MXBM-C constraint within its ranking *R*, seen in (16)b.

(16) Content of dominant GT trigger *mí* ‘this’

- a. /mí<sup>Ⓣ</sup> / ‘this’ (neut.) + /bèlè / ‘light’ → \ mí bèlé \ ‘this light’
- b. 
$$\left\{ \begin{array}{l} \underline{\text{Demonstrative}} \\ M: [\text{DEM}][\text{NEUT}] \\ F: /mí^{\text{Ⓣ}} / \\ P: - \\ R: \text{MXBM} \gg \text{IO(TONE)} \end{array} \right\}$$

[Kalabari – Harry & Hyman 2014]

To understand how the appropriate basemap is selected, we must explore the internal structure of MXBM-C constraints themselves. The internal structure that I adopt is based on Hansson’s (2014) model of **Agreement by Projection (ABP)**, which is a modification to the **Agreement by Correspondence (ABC)** architecture originally developed to handle consonant harmony (Rose & Walker 2004).<sup>6</sup> Hansson’s central innovation is to “conflate the work of (high-

<sup>6</sup> A bibliography of ABC has been compiled here by Stephanie Shih & Sharon Inkelas: <http://linguistics.berkeley.edu/~inkelas/ABCBibliography.html>

ranked) Corr constraints and CC-Ident[F] into a single constraint” (p. 17). Important to this idea is the concept of **projection**:

*“Any well-defined class of segments defines (projects) a subsequence of the output string, consisting of all and only the segments belonging to that class, e.g. the subsequence of a string S which results from ‘removing’ all non-members of the natural class [+F, -G, +H] from S”*

[Hansson 2014:15, bolding his]

For example, Hansson shows several projections of the word <choosiness> /tʃuzɪnɛs/: the projection [<sub>α</sub>PLACE] would pick out [tʃ...z...n...s], the projection [+STRIDENT, <sub>α</sub>CONT] would pick out [...z...s], etc.

The basic idea is that segments along a projection must also show ‘agreement’ for some other feature. For example, a familiar case in consonant harmony is from Kikongo (Rose & Walker 2004:510), which shows nasal harmony in the input-output mapping /nik -ulu/ → \n<sub>i</sub>ik-un<sub>i</sub>u\ . Under Agreement by Projection, the segments /n/ and /l/ are defined by a projection of [CORONAL][+SONORANT], and must therefore also show agreement for nasality [<sub>α</sub>NASAL]. The basic constraint would look as in (17) which conventionalizes the position of the [agreement] and [projection] portions.<sup>7</sup>

- (17) Basic ABP constraint
- a. Structure: [Agreement]<sub>[Projection]</sub>
  - b. Example: [<sub>α</sub>NAS]<sub>[COR,+SON]</sub>

This theory is designed to handle phonological phenomena such as consonant harmony. We can extend it to handle the morphophonological data here via MxBM-C (see Rolle to appear for additional details on this extension). It is advantageous to unify the independently developed models of Output-Output Correspondence (OO-Corr) for morphophonology and Agreement by Projection (ABP) for phonology, as both formalize the insight that linguistic units which are similar are intimately connected, a connection which fosters further similarity.

First, using terms used in Hansson we can call the projection the **similarity condition** and agreement the **similarity imperative**. The internal structure of MxBM-C constraints going forward will then take on the following shape:

- (18) Internal structure of MxBM-C constraints
- $$O_{MX}O_{BM}(\text{Similarity\_Imperative})_{\left[ \begin{array}{l} \text{Similarity\_Condition} \\ M: [+F] \\ F: /.../ \end{array} \right]}$$

The similarity condition is the standing similarity between the matrix derivation and the basemap derivation(s). In the MxBM-C constraint, this portion is subscripted [ ] and picks out the relevant projection along which similarity is assessed. In this schema above, the similarity condition is assessed according to whether vocabulary items in the two derivations share the same morphosyntactic feature [+F]. If this similarity condition is met, then a similarity imperative is enforced. In the schema above, this imperative is some identity relation between the matrix (O<sub>MX</sub>) and basemap outputs (O<sub>BM</sub>) along some dimension.

<sup>7</sup> Note that Hansson actually uses a constraint schema \*[-F][+F]<sub>[αG,βH]</sub> rather than alpha notation in the agreement portion.

To exemplify, consider the *capitalistic/capital* example introduced above. In this example, I follow Davis’ (2005) analysis that identity of foot structure is ultimately what licenses these /t/ variants. We can posit the following (abbreviated) constraint to handle this case:

(19)

$$O_{MX}O_{BM}(\text{FOOT\_STRUCTURE})_{\left[ \begin{array}{l} M: [\alpha\text{ROOT}] \\ F: - \end{array} \right]} \left[ \_ \right]$$

In short, this constraint states that if the matrix and basemap input have the same root (the similarity condition), then they must have the same foot structure as well (the similarity imperative). This constraint operating within a tableau is below (note that I do not provide the foot structure in order to provide a tidier representation).

$ I_{MX} $	/√CAPITAL –[ADJ] / / capital –istic /		$O_{MX}O_{BM}(\text{FOOT\_STRUC})_{[M: \alpha\text{ROOT}]}$	MARKEDNESS	IDENT-IO
$ O_{MX} $	a.	$\text{\c}à\text{p}i[\text{r}]alístic \$		*	*
	b.	$\text{\c}à\text{p}i[\text{t}^h]alístic \$	*!		*
	c.	$\text{\c}à\text{p}i[\text{t}]alístic \$	*!	*	

$\ I_{BM}\ $	//√CAPITAL // // capital //
$\ O_{BM}\ $	\ \cà\text{p}i[\text{r}]al \

Tableau 4: Illustration of  $O_{MX}O_{BM}$  constraint enforcing faithfulness to a basemap output

The matrix derivation is given at the top in the familiar tableau format. This has a highly ranked MXBM-C constraint, which picks out a projection of forms sharing the same root, in this case the VI *capital*. This is then the selected basemap, which undergoes a parallel basemap input-output derivation //capital// → \cà\text{p}i[\text{r}]al\.<sup>8</sup> The constraint  $O_{MX}O_{BM}(\text{FOOT\_STRUC})_{[M: \alpha\text{ROOT}]}$  assesses whether the inputs share the same root, which they do, and thereafter parasitically assesses identity for foot structure, which in these tableau manifests as the distinct realization of [t]. This MXBM-C constraint in the matrix tableau is crucially ranked above a MARKEDNESS constraint which prefers [t<sup>h</sup>] and an IO-IDENT constraint which prefers faithful [t].

### 5.3.2 Replacive-dominant GT

The previous subsection shows that *selection* of a basemap is the result of the projection component of the MXBM-C constraint (subscripted  $[\_]$ ), while *faithfulness* to the basemap is the result of the agreement component. Let us now examine how this captures the dominant GT patterns and how this constitutes a transparadigmatic uniformity effect, starting with replacive-dominant GT. A condensed version of the now-familiar Kalabari data is repeated below.

- (20) a. / mí<sup>ⓁⓅ</sup> / ‘this’ (neut.) + / nà\má / ‘meat’ → \ mí nà\má \ ‘this meat’  
 b. / mí<sup>ⓁⓅ</sup> / ‘this’ (neut.) + / bè\lè / ‘light’ → \ mí bè\lè \ ‘this light’ *etc.*

The structure of the input for (20)a. therefore needs to resemble the following:

<sup>8</sup> I do not discuss how other words sharing this root are ignored - e.g. *capitals, capitalist, capitalism, etc.* - which would take us too far afield.

(21) Kalabari input with articulated VI structure:

$$\left\{ \begin{array}{l} \text{Demonstrative} \\ M: [\text{DEM}][\text{NEUT}] \\ F: / \text{mi}^{\text{ⓉⓈ}} / \\ P: - \\ R: \text{MxBM} \gg \text{IO}(\text{TONE}) \end{array} \right\} \left\{ \begin{array}{l} \text{Noun} \\ M: [\sqrt{\text{MEAT}}] \\ F: / \text{námá} / \\ P: - \\ R: - \end{array} \right\}$$

Let us further articulate of the GT trigger's ranking in *R*:

(22) Articulated ranking in *R* of demonstrative *mí* 'this':

$$\text{O}_{\text{MX}}\text{O}_{\text{BM}}(\text{TONE})_{[\{M: \text{DEM}\} \{F: \alpha\tau\}]} \gg \text{IO}(\text{TONE}) \gg \text{O}_{\text{MX}}\text{O}_{\text{BM}}(\text{TONE})_{[\{M: \alpha\text{STEM}\}]}$$

The first MxBM-C constraint enforces identical tones in constituents which share the same demonstrative ( $\dots[\{M: \text{DEM}\}]\dots$ ) and whose target has the same number of tone-bearing units ( $\dots[\{F: \alpha\tau\}]\dots$ ). A second MxBM-C constraint is ranked below IO(TONE) faithfulness, and enforces identical tones in constituents whose target shares the same root. This is ranked low enough to not have an influence. Full definitions of these constraints are provided in (23) below.

(23) Definitions of constraints:

$$\text{a. } \text{O}_{\text{MX}}\text{O}_{\text{BM}}(\text{TONE})_{\left[ \left\{ \begin{array}{l} \text{VI-1} \\ M: [\text{DEM}][\text{NEUT}] \\ F: - \\ P: - \\ R: - \end{array} \right\} \left\{ \begin{array}{l} \text{VI-2} \\ M: [+N] \\ F: \alpha\tau \\ P: - \\ R: - \end{array} \right\} \right]} \quad (\text{shorthand: } \text{O}_{\text{MX}}\text{O}_{\text{BM}}(\text{T})_{[\{M: \text{DEM}\} \{F: \alpha\tau\}]})$$

If a matrix input ( $I_{\text{MX}}$ ) and basemap input ( $I_{\text{BM}}$ ) share (i) the features [DEMONSTRATIVE][NEUTER] in the first VI ( $\text{VI}_1$ ), and (ii) the same number of tone-bearing units  $\tau$  in the second VI ( $\text{VI}_2$ ), then all tone structure in the matrix output ( $O_{\text{MX}}$ ) must be present in the basemap output ( $O_{\text{BM}}$ )

b. IO(TONE)

All tone structure in the matrix input ( $I_{\text{MX}}$ ) must be present in the matrix output ( $O_{\text{MX}}$ )

c.  $\text{O}_{\text{MX}}\text{O}_{\text{BM}}(\text{TONE})_{[\{\alpha\text{VI-2}\}]} \quad (\text{shorthand: } \text{O}_{\text{MX}}\text{O}_{\text{BM}}(\text{T})_{[\{\alpha\text{STEM}\}]})$

If a matrix input ( $I_{\text{MX}}$ ) and basemap input ( $I_{\text{BM}}$ ) share the same STEM – i.e.  $\{\alpha\text{VI}_2\}$ , the Vocabulary Item  $\text{VI}_2$  – then all tone structure in the matrix output ( $O_{\text{MX}}$ ) must be present in the basemap output ( $O_{\text{BM}}$ )

These  $\text{O}_{\text{MX}}\text{O}_{\text{BM}}(\text{TONE})$  constraints pick out the relevant projection within which similarity is assessed, and if this passes the similarity condition, then the similarity imperative is enforced, namely identical corresponding tone structure.

The full tableau illustrating how this proceeds is below. The matrix tableau is provided at the top using the single slash convention, and the basemap tableau is provide below this using the double slash convention. Note that I provide different colors for the trigger (black) and target (red) for maximal clarity. More than one basemap are provided, even though only one plays an influencing role. I call the collection of potential basemaps the **basemap pool**.

$\left\{ \begin{array}{l} \text{Demonstrative} \\ M: [\text{DEM}][\text{NEUT}] \\ F: / \text{mí}^{\text{L}\text{H}} / \\ P: - \\ R: \text{MxBM} \gg \text{IO}(\text{TONE}) \end{array} \right\} \left\{ \begin{array}{l} \text{Noun} \\ M: [\sqrt{\text{MEAT}}] \\ F: / \text{námá} / \\ P: - \\ R: - \end{array} \right\} /$				
$\text{H}^{\text{L}\text{H}} \text{H H}$ $/ \text{mí}^{\text{L}\text{H}} \text{námá} /$		$\text{O}_{\text{MX}}\text{O}_{\text{BM}}(\text{T})_{[\{M: \text{DEM}\} \{F: \alpha\tau\}]}$	$\text{IO}(\text{T})$	$\text{O}_{\text{MX}}\text{O}_{\text{BM}}(\text{T})_{[\{\alpha\text{STEM}\}]}$
a.	$\text{H}^{\text{L}\text{H}} \text{H H}$ $\backslash \text{mí} \text{námá} \backslash$	<i>Replacive-Dominant</i>		2
b.	$\text{H}^{\text{L}\text{H}} \text{H H}$ $\backslash \text{mí} \text{námá} \backslash$	<i>Partial-replacive</i>	$\text{W}$ (0~1)	$\text{L}$ (2~1)
c.	$\text{H}^{\text{L}\text{H}} \text{H H}$ $\backslash \text{mí} \text{námá} \backslash$	<i>Recessive</i>	$\text{W}$ (0~2)	$\text{L}$ (2~0)
d.	$\text{H}^{\text{L}\text{H}} \text{H H}$ $\backslash \text{mí} \text{námá} \backslash$	<i>Neutral R-dock</i>	$\text{W}$ (0~2)	$\text{L}$ (2~1)
e.	$\text{H}^{\text{L}\text{H}} \text{H H}$ $\backslash \text{mí} \text{námá} \backslash$	<i>Neutral L-dock</i>	$\text{W}$ (0~2)	$\text{L}$ (2~1)
f.	$\text{H}^{\text{L}\text{H}} \text{H H}$ $\backslash \text{mí} \text{námá} \backslash$	<i>Subtractive-dominant</i>	$\text{W}$ (2~4)	$\text{L}$ (2~0)

$\  \text{I}_{\text{BM}} \ $	$\left\{ \begin{array}{l} \text{Demonstrative} \\ M: [\text{DEM}][\text{NEUT}] \\ F: / \text{mí}^{\text{L}\text{H}} / \\ R: \text{MxBM} \gg \text{IO}(\text{T}) \end{array} \right\} \{F: / \tau\tau / \} //$	$\left\{ \begin{array}{l} \text{Noun} \\ M: [\sqrt{\text{MEAT}}] \\ F: / \text{námá} / \end{array} \right\} //$
	$\text{H}^{\text{L}\text{H}} \text{H H}$ $// \text{mí} \tau\tau //$	$\text{H H}$ $// \text{námá} //$
$\  \text{O}_{\text{BM}} \ $	$\text{H}^{\text{L}\text{H}} \text{H H}$ $// \text{mí} \tau\tau //$	$\text{H H}$ $// \text{námá} //$

BASEMAP POOL

Tableau 5: Replacive-dominant GT via MxBM-C

The matrix input ( $\text{I}_{\text{MX}}$ ) in the top left are the contents of the two vocabulary items from (21) above; I abbreviate this as  $/\text{mí}^{\text{L}\text{H}} \text{námá}/$ . Below this are the output candidates, notated with the type of GT pattern which they exhibit. Candidate a. shows the replacive-dominant pattern (the winner) where underlying  $/\text{HH}/$  tones are replaced with  $/\text{LH}/$ . Other patterns include partial-dominant, recessive, two neutral patterns, and subtractive-dominant.

The logic of this tableau is clear: the dominant pattern wins because its candidate is more faithful to the basemap output. The replacive-dominant pattern wins over the subtractive-dominant because it violates less instances of  $\text{IO}(\text{T})$ , the latter having egregious deletion. What requires explanation are the steps involved in the basemap derivation.

Recall the structure of the top-ranked MxBM-C constraint in (23)a repeated below, whose shorthand is  $\text{O}_{\text{MX}}\text{O}_{\text{BM}}(\text{TONE})_{[\{M: \text{DEM}\} \{F: \alpha\tau\}]}$ . Recall that the portion in the ( ) is the similarity imperative enforcing agreement, while the portion in the subscripted [ ] is the similarity condition which picks out the relevant projection along which similarity is assessed.

(24)

$$O_{MX}O_{BM}(TONE) \left[ \left. \begin{array}{l} \text{VII} \\ M: [\text{DEM}][\text{NEUT}] \\ F: - \\ P: - \\ R: - \end{array} \right\} \left. \begin{array}{l} \text{VI2} \\ M: [+N] \\ F: \alpha\tau \\ P: - \\ R: - \end{array} \right\} \right]$$

This projection has two parts. The first part picks out a VI which share the morphological features [DEM][NEUT]. This is a set consisting only a single member, the demonstrative /mí<sup>Ⓣ</sup>/ ‘this’. In contrast, the second part picks out a VI set consisting of all nouns which share the same number of TBUs ( $F: \alpha\tau$ ). In this case, because the input is /námá/ ‘meat’ with two TBUs, this picks out all 2- $\tau$  nouns. This set of nouns is both potentially infinite and whose contents are insufficiently similar to one another by bearing distinct meaning, segments, and tones. This diversity is shown below in (25)a. with a small sample of bisyllabic nouns which would meet the similarity condition.

(25) Vocabulary Items matching similarity condition [...{ $F: \alpha\tau$ }] of constraint

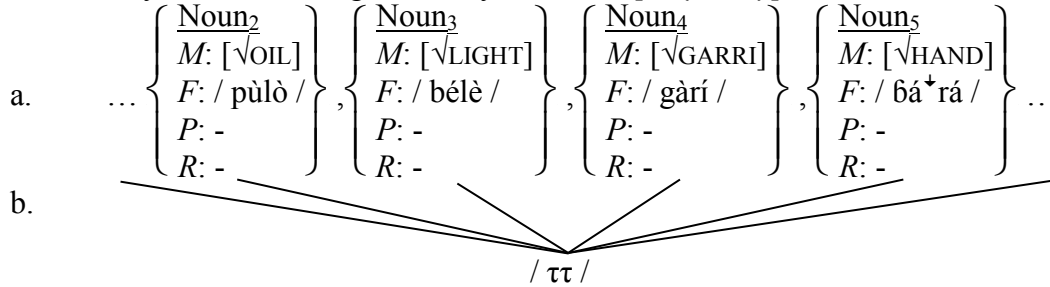

In this situation, I claim that the constraint picks out a **deficient projection**. In this case, the VIs do not *individually* act as basemap. Instead, I claim that the deficient projection is ‘repaired’ by extracting the common feature in *all* of the VIs, a process I call **basemap induction**.

[Def 2] **Basemap induction**

Given a deficient projection, induce a basemap input based on the common shared feature of all VIs

In (25), the common feature of all the VIs is having two tone-bearing units, and therefore a structure /ττ/ with unvalued tones is ‘induced’ as the basemap. No tonal or meaning structure is induced as it is not shared. The induced basemap as a whole consists of this induced portion plus the non-deficient portion of the projection, the demonstrative trigger. This results in a basemap input //mí<sup>Ⓣ</sup> ττ//. In this way, the members of the deficient projection *collectively influence* the matrix derivation, rather than individually influence it.<sup>9</sup>

This type of correspondence relation constitutes the last type of OO-Corr as indicated in the typology in (7)d above, repeated below.

<sup>9</sup> Compare this idea where the base is the “common denominator” to that of Braver’s (2013) discussion of “canonhood” and the base: “a base is in some way a more *canonical* version of the candidate” (p. 120, italics his).



(26)	Transparadigmatic OO-Corr (root)	Matrix	↔	Basemap
		W-Y		X-Y
	e.g.	[ROOT <sub>1</sub> ]-AFX <sub>1</sub>		[ROOT <sub>2</sub> ]-AFX <sub>1</sub>

In this case, the outputs share the same outer morphology (i.e. AFX<sub>1</sub>) but have different roots. This is equivalent to Pariente’s (2012) ‘Grammatical Paradigm Uniformity’ which develops a formal correspondence model “between words sharing a Morphological Structure, but not sharing a lexeme”.

An unabridged version of this basemap derivation is given in Tableau 6 below (this corresponds to the bottom portion of Tableau 5 above). This shows that the basemap input is //mí<sup>ⓁⓂ</sup> ττ// which shares the same demonstrative modifier *mí* (equivalent to –AFX<sub>1</sub> in (26) above), but has a distinct root, here the abstract ‘root’ //ττ// (as a target, it is notated in red for maximal clarity).

$\left. \begin{array}{l} \text{Demonstrative} \\ M: [\text{DEM}][\text{NEUT}] \\ F: / \text{mí}^{\text{ⓁⓂ}} / \\ P: - \\ R: \text{MxBM} \gg \text{IO(T)} \end{array} \right\} \{ F: \tau\tau \} //$					
$\text{H}^{\text{ⓁⓂ}} \text{ } \emptyset \emptyset$ $// \text{mí}^{\text{ⓁⓂ}} \tau\tau //$		$\text{O}_{\text{MX}} \text{O}_{\text{BM}}(\text{T})$ <small>[[M: DEM] {F: ατ}]</small>	$\text{IO(T)}$	$\text{O}_{\text{MX}} \text{O}_{\text{BM}}(\text{T})$ <small>[[STEM]]</small>	<b>MARKED- NESS</b>
a.	$\text{H} \text{ } \text{Ⓛ} \text{Ⓜ}$ $// \text{mí} \tau\tau //$	<i>Neutral 1</i>			
b.	$\text{H} \text{Ⓛ} \text{ } \text{Ⓜ}$ $// \text{mí} \tau\tau //$	<i>Neutral 2</i>			<b>W</b> (0~1)
c.	$\text{H}^{\text{ⓁⓂ}} \text{ } \emptyset \emptyset$ $// \text{mí} \tau\tau //$	<i>Fully faithful</i>			<b>W</b> (0~2)
d.	$\text{H} \text{ } \emptyset \emptyset$ $// \text{mí} \tau\tau //$	<i>Recessive</i>	<b>W</b> (0~2)		

Tableau 6: Full basemap tableau with basemap induction

I present four candidates. The first (a.) is the winner, in which the floating tones dock to the unvalued TBUs of //ττ// and thereby value them, resulting in an output form //mí τ̣τ̣\\. Candidates b. and c. violate a markedness constraint against having unvalued TBUs (other markedness constraints could be devised to eliminate these candidates as well). Finally, candidate d. is recessive in that the grammatical tune automatically does not dock, but is an egregious violation of IO(TONE) in deleting these input floating tones. Note that in this tableau, the basemap input-output mapping does not incur any violations of any MXBM-C constraint, as the basemap itself does not have a (relevant) basemap against which its identity is assessed.

We can now return to the full tableau, Tableau 5 above. To condense the basemap tableau, I simply include the input-output mapping itself:

$$(27) \quad \begin{array}{ccc} \text{H}^{\text{ⓁⓂ}} \text{ } \emptyset \emptyset & & \text{H} \text{ } \text{Ⓛ} \text{Ⓜ} \\ // \text{mí} \quad \tau\tau // \rightarrow & & // \text{mí} \quad \tau\tau // \end{array}$$

The replacive-dominant candidate //mí nàmá\\ wins because it is most faithful to the basemap output with whom it shares the same tonal structure, i.e. //mí τ̣τ̣\\. This is schematized below:

		INPUT			OUTPUT							
Kalabari replacive- dominant GT	MATRIX     Mx	/	H <sup>ⓁⓂ</sup>   mí	+	H L     béle	/	→	\	H <sup>ⓁⓂ</sup>   mí	bèlé	\	‘this light’ (cf. [béle])
	BASEMAP       BM	//	H <sup>ⓁⓂ</sup>   mí	+	∅ ∅     τ τ	//	→	\\	H <sup>ⓁⓂ</sup>   mí	τ τ	\\	

Table 2: Schematic structure of dominant GT via MxBM-C

Here the blue arrow and outline indicate the basemap induction of the abstract basemap input //ττ/. The red arrow indicates the influence the subsequent basemap output has on the matrix output, whose tonal structure is identical. Ultimately, the matrix output must be faithful to the basemap output structure, i.e. \H<sup>ⓁⓂ</sup>\.<sup>10</sup>

This analysis directly addresses two problems introduced in Chapter 4: the erasure problem and the origin problem. The erasure problem asks how are the underlying tones deleted? The ‘locus of erasure’ in my model is basemap induction, which, by extracting the most common structure from the deficient projection, does not preserve any underlying tones. In this way erasure is indirect, captured via correspondence to an abstract basemap. Although the basemap //ττ/ is abstract and not an independently occurring form, it follows from the Principle of No Basemap Restriction as stated above: “there are no restrictions placed on linguistic form of the basemap input”.<sup>11</sup>

<sup>10</sup> One may therefore understand this output shape as something comparable to a template which the matrix output strives to match, familiar to many different templatic/construction approaches to morphophonology such as Construction Morphology (e.g. Booij 2010a, 2010b). Such an approach to GT is advocated for by McPherson (2014). For example, in (i) below from Tommo So [dto], McPherson shows negation expressed in part by a L tone on the verb stem, which McPherson indicates with a superscript <sup>L</sup>. A construction schema is in (ii), where {L} marks the V<sub>stem</sub>, expressing [NEGATIVE].

- (i) jòb<sup>L</sup>-éélè  
run\NEG-IPFV.NEG  
‘does/will not run’
- (ii) Construction schema for Tommo So negatives (McPherson 2017c)
- $$\{ \quad \quad \quad \}_{\text{stem}} \leftrightarrow V_{\text{stem}} \leftrightarrow [\text{NEGATIVE}]$$
- $$\{ \quad | \quad \quad \} \\ \{ \quad L \quad \quad \}$$

McPherson (2017c) notes that this entire construction schema itself is the constraint which evaluates candidates, “militating that outputs matching the morphosyntactic description take the proscribed morphophonological form.”

<sup>11</sup> A comparable use of abstract structure in linguistic correspondence is found in Blumenfeld (2015) in his theory of meter using template-text (TT) correspondence. The core of this proposal is that meter can be understood as similarity (i.e. faithfulness) “between an abstract metrical template consisting of prosodic structure without segmental content, and the prosodic structure of a line of verse” (p. 79). The text is the linguistic structure, e.g. in the first example below where the text has stress on the nouns (*of hánd of fóot of lip of éye of brów* – Shakespeare Sonnet 106). In this example, there is a perfect match (complete identity) between the prosodic structure (the text) and the iambic pentameter (the template).

- (i) Perfect match of text and template (Blumenfeld 2015:93)
- |               |             |             |             |             |             |             |             |             |             |             |
|---------------|-------------|-------------|-------------|-------------|-------------|-------------|-------------|-------------|-------------|-------------|
|               |             | *           |             | *           |             | *           |             | *           |             | *           |
| Text          | ( . ( * ) ) | ( . ( * ) ) | ( . ( * ) ) | ( . ( * ) ) | ( . ( * ) ) | ( . ( * ) ) | ( . ( * ) ) | ( . ( * ) ) | ( . ( * ) ) | ( . ( * ) ) |
|               | * ( * )     | * ( * )     | * ( * )     | * ( * )     | * ( * )     | * ( * )     | * ( * )     | * ( * )     | * ( * )     | * ( * )     |
|               | of hand     | of foot     | of lip      | of eye      | of brow     |             |             |             |             |             |
| Temp-<br>late | ( * * )     | ( * * )     | ( * * )     | ( * * )     | ( * * )     | ( * * )     | ( * * )     | ( * * )     | ( * * )     | ( * * )     |
|               |             | *           |             | *           |             | *           |             | *           |             | *           |
- ...

Secondly, the origin problem asks how is the grammatical tune introduced and how does it get to its surface position? This model analyzes the grammatical tune involved in dominant GT as floating tones, which is in line with **Generalized Non-Linear Affixation theory** (Bermúdez-Otero 2012; see also earlier work in Poser’s 1982 ‘feature-changing rules’, and later Saba Kirchner 2010; Trommer 2011; Bye & Svenonius 2012; Trommer & Zimmermann 2014; Zimmermann 2017; Paschen 2018; a.o.). The central premise of this theory is that non-concatenative morphology such as replacive tone be attributed to affixation of non-segmental material, of which floating tones are but one type. Thus, the floating tones <sup>Ⓛ</sup> are introduced into the derivation in the same way as any other exponence, such as segmental exponence like English /ɪz/ ‘is’ for [COPULA][3][SG][PRESENT]. However, my model attributes the erasure aspect of dominant GT to the mechanics of output-output constraints and particular MxBM-C constraints highly ranked by triggering vocabulary items, positions not generally taken by proponents of Generalized Non-Linear Affixation theory.

### 5.3.3 Subtractive-dominant GT

Subtractive-dominant GT can be modelled in the same was as replacive-dominant GT with one difference: the trigger has no floating tones. Consider the following subtractive-dominant pattern from Japanese with the subtractive suffix *-teki* ‘-like’. When this suffix is concatenated with a nominal host, the underlying tone of the noun deletes. Note that critically *-teki* itself is toneless, and therefore this pattern cannot be attributed to tonal culminativity (an inviolable constraint in Japanese).

Other structure, though, shows an imperfect match, e.g. between the text (*after an interval his instrument*) and the template.

(ii) Imperfect match of text and template (Blumenfeld 2015:93)

		Text							
*		*		*					
( *	. )	( .	( *	. . ) )	( .	( *	. . ) )		
( *	* )	* (	( *	* )	* )	* (	( *	* )	* )
af	ter	an	in-	ter-	val	his	in-	stru-	ment
( *	* )	( *	* )	( *	* )	( *	* )	( *	* )
	*		*		*		*		*
			Template						

Identity between these structures is assessed according to familiar OT constraints (e.g. MAX, DEP, ALIGN, NO-FLOP, etc.). To facilitate an OT analysis of meter, Blumenfeld states that “let us assume ‘input’ to mean ‘template’, and ‘output’ to mean ‘text’” (p. 96). Like Matrix-Base map correspondence, template-text correspondence also involves structure which is underspecified for linguistic structure. He states that templates are analogous to underlying forms in the input of a tableau:

*“Metrical templates are analogous to underlying forms—they are like inputs, albeit not fully specified ones, to which the text strives to be similar”*

[Blumenfeld 2015:85-86]

*“A feature of templates that sets them aside from ordinary prosody is their underspecified character. For one thing, templates lack segmental information. But even the prosodic structure need not be fully articulated in a well-formed template. A template may consist only of representations at levels 1 and above, or 2 and above, and so forth. Likewise, the higher-level organization of the units of a template need not be fully specified.”*

[Blumenfeld 2015:90]

(28) Subtractive-dominant GT

	/...H.../			\...Ø...\		
a.	/ anáta	+	-teki /	→	\ anata-teki \	‘in your opinion’
b.	/ rónri	+	-teki /	→	\ ronri-teki \	‘logical’
c.	/ búngaku	+	-teki /	→	\ bungaku-teki \	‘literature-like’

[Japanese – Kawahara 2015:470]

The structure of the VI’s is below, illustrated with /rónri-teki/ ‘logical’ (b.). As a shorthand, I will simply denote *-teki*’s morphological features as [ADJ].

(29) Japanese input with articulated VI structure:

<u>Noun</u> <i>M</i> : [√LOGIC] <i>F</i> : / rónri / <i>P</i> : - <i>R</i> : -	<u>Like</u> <i>M</i> : [ADJ] <i>F</i> : / teki / <i>P</i> : - <i>R</i> : Mx <sub>BM</sub> » IO(T)
--	---

H / rónri -teki /		O <sub>MX</sub> O <sub>BM</sub> (T) [ {F: ατ} {M: ADJ} ]	IO(T)	O <sub>MX</sub> O <sub>BM</sub> (T) [ {αSTEM} ]
a.	Ø / ronri -teki /	<i>Subtractive-dominant</i>	1	
b.	H / rónri -teki /	<i>No deletion</i>	W (0~1)	L (1~0)  (0~0)

I <sub>BM</sub>	<div style="display: flex; align-items: center; justify-content: center;"> <div style="border-left: 1px solid black; border-right: 1px solid black; padding: 5px;">           // F: / ττ /         </div> <div style="border-left: 1px solid black; border-right: 1px solid black; padding: 5px; margin: 0 10px;"> <table style="border-collapse: collapse;"> <tr><td style="text-align: center;"><u>Like</u></td></tr> <tr><td style="text-align: center;"><i>M</i>: [ADJ]</td></tr> <tr><td style="text-align: center;"><i>F</i>: / teki /</td></tr> <tr><td style="text-align: center;"><i>P</i>: -</td></tr> <tr><td style="text-align: center;"><i>R</i>: Mx<sub>BM</sub> » IO(T)</td></tr> </table> </div> <div style="margin: 0 10px;">//</div> <div style="border-left: 1px solid black; border-right: 1px solid black; padding: 5px;"> <table style="border-collapse: collapse;"> <tr><td style="text-align: center;"><u>Noun</u></td></tr> <tr><td style="text-align: center;"><i>M</i>: [√LOGIC]</td></tr> <tr><td style="text-align: center;"><i>F</i>: / rónri /</td></tr> <tr><td style="text-align: center;"><i>P</i>: -</td></tr> <tr><td style="text-align: center;"><i>R</i>: -</td></tr> </table> </div> <div style="margin: 0 10px;">//</div> </div>	<u>Like</u>	<i>M</i> : [ADJ]	<i>F</i> : / teki /	<i>P</i> : -	<i>R</i> : Mx <sub>BM</sub> » IO(T)	<u>Noun</u>	<i>M</i> : [√LOGIC]	<i>F</i> : / rónri /	<i>P</i> : -	<i>R</i> : -
<u>Like</u>											
<i>M</i> : [ADJ]											
<i>F</i> : / teki /											
<i>P</i> : -											
<i>R</i> : Mx <sub>BM</sub> » IO(T)											
<u>Noun</u>											
<i>M</i> : [√LOGIC]											
<i>F</i> : / rónri /											
<i>P</i> : -											
<i>R</i> : -											
	<table style="width: 100%; border-collapse: collapse;"> <tr> <td style="width: 50%; text-align: center;">ØØ ØØ</td> <td style="width: 50%; text-align: center;">H Ø</td> </tr> <tr> <td style="text-align: center;">// ττ -teki //</td> <td style="text-align: center;">// rónri //</td> </tr> </table>	ØØ ØØ	H Ø	// ττ -teki //	// rónri //						
ØØ ØØ	H Ø										
// ττ -teki //	// rónri //										
O <sub>BM</sub>	<table style="width: 100%; border-collapse: collapse;"> <tr> <td style="width: 50%; text-align: center;">ØØ ØØ</td> <td style="width: 50%; text-align: center;">H Ø</td> </tr> <tr> <td style="text-align: center;">\\ ττ -teki \\</td> <td style="text-align: center;">\\ rónri \\</td> </tr> </table>	ØØ ØØ	H Ø	\\ ττ -teki \\	\\ rónri \\						
ØØ ØØ	H Ø										
\\ ττ -teki \\	\\ rónri \\										

Tableau 7: Subtractive-dominant GT via Mx<sub>BM</sub>-C

As in the Kalabari case with replacive-dominant GT, This Japanese construction involves a highly ranked O<sub>MX</sub>O<sub>BM</sub>(T)<sub>[ {F: ατ} {M: ADJ} ]</sub> constraint. This constraint has a deficient projection, which results in all bimoraic (the relevant TBU) nouns being picked out. From this, basemap induction takes place, resulting in a toneless basemap input, i.e. //ττ//. The basemap input //ττ -teki// is then mapped to the basemap output \\ττ-teki\\ according to the general phonology of the language. The constraint states that all tonal structure present in the matrix output must also be present in the basemap. This results in a candidate with no tones being optimal, rather than the

fully faithful one which satisfies IO(TONE).<sup>12</sup> Again, the locus of erasure here is in the output-to-output correspondence.

This is schematized below, parallel to the schema in Table 2 above:

b. Japanese Subtractive- Dominant	MATRIX	/	H	+	teki	/	→	\	∅∅	\	‘logical’ (cf. [rónri])
	MX	/	rónri	+	teki	/	→	\	ronri -teki	\	
	BASEMAP	//	∅∅	+	teki	//	→	\\	∅∅	\\	
	BM	//	ττ	+	teki	//	→	\\	ττ -teki	\\	

Table 3: Dominant GT via abstract Matrix-Basemap Correspondence (MXBM-C)

As above, the blue arrow and outline indicate the basemap induction of the abstract basemap input //ττ//, while the red arrow indicates the influence the subsequent basemap output has on the matrix output, i.e. the lack of tonal structure, thus leading to the erasure effect.

## 5.4 Comparison to non-dominant GT

### 5.4.1 Recessive GT

In replacive-dominant GT (Tableau 5 above), we saw constraints which were violated by the winning candidate. One was a lower-ranked MXBM-C constraint  $O_{MX}O_{BM}(TONE)_{[\{STEM\}]}$  which enforces faithfulness to the tonal structure of an input-output mapping consisting of the STEM, i.e. //námá// → \\námá\\. I show here how this type of stem-based constraint plays a role in analyzing recessive-non-dominant GT.

In Chapter 3, I presented a definition of recessive GT:

- (30) **Recessive-non-dominant GT:** the non-application of the grammatical tune when a target-host is valued within its valuation window (occurs within privative-culminative systems)

A model of recessive GT must capture both this non-application in the face of existing tonal structure, and why it is restricted to **privative-culminative systems**. Recessive patterns are frequent in Indo-European accent systems (e.g. the Sanskrit example from chapter 3), and for tone, recessive GT has been identified for a number of constructions. These include the following:

<sup>12</sup> Note that Japanese has default prosodic structure which values unvalued TBUs, which I assume comes in at later cycle. The basemap output and matrix output are identical for tonal structure both at this juncture and any subsequent derivational stage. Therefore, regardless of whether the basemap output here is toneless or has default tones, this will be compatible with the MXBM-C model of dominance effects.

Language	Construction	Culminativity	Applies	Does not apply
a. Japanese	/- <sup>Ⓣ</sup> si/ ‘Mr.’	*H...H	/ $\emptyset\emptyset\emptyset + -^{\text{Ⓣ}}\emptyset$ / \ $\emptyset\emptyset\text{Ⓣ}-\emptyset$ \	/ $\text{H}\emptyset\emptyset + -^{\text{Ⓣ}}\emptyset$ / \ $\text{H}\emptyset\emptyset-\emptyset$ \
b. Giphende	/ <sup>Ⓣ</sup> <sub>1</sub> / [FOCUS]	*H...H	/ <sup>Ⓣ</sup> <sub>1</sub> + $\emptyset-\emptyset\emptyset$ / \ $\text{Ⓣ}-\text{Ⓣ}\emptyset$ \	/ <sup>Ⓣ</sup> <sub>1</sub> + $\emptyset-\emptyset\text{H}$ / \ $\emptyset-\emptyset\text{H}$ \
c. Giphende	/ <sup>Ⓣ</sup> <sub>2</sub> / [GENITIVE]	*HH	/ <sup>Ⓣ</sup> <sub>2</sub> + $\emptyset-\emptyset\text{H}$ / \ $\text{Ⓣ}-\emptyset\text{H}$ \	/ <sup>Ⓣ</sup> <sub>1</sub> + $\emptyset-\text{H}\emptyset$ / \ $\emptyset-\text{H}\emptyset$ \
d. Jita	/amá-/ [YP] ‘yesterday past’	*HH	/ $\emptyset\text{H} + \emptyset\emptyset\emptyset$ / \ $\emptyset\text{H}-\emptyset\emptyset\emptyset$ \	/ $\emptyset\text{H} + \text{H}\emptyset\emptyset$ / \ $\emptyset\emptyset-\text{H}\emptyset\emptyset$ \
e. Jita	/ <sup>Ⓣ</sup> <sub>Ⓣ</sub> / [PRESENT CONTINUOUS]	*[HH] <sub>root</sub> (?)	/ <sup>Ⓣ</sup> <sub>Ⓣ</sub> + $\emptyset\emptyset\emptyset$ / \ $\emptyset\text{Ⓣ}\emptyset$ \	/ <sup>Ⓣ</sup> <sub>Ⓣ</sub> + $\text{H}\emptyset\emptyset$ / \ $\text{H}\emptyset\emptyset$ \

Table 4: Recessive GT patterns

The Japanese case from chapter 3 involves /-<sup>Ⓣ</sup>si/ ‘Mr.’ which assigns a high tone to the preceding TBU if and only if the entire target-host is unvalued, containing no underlying tone. I repeat a relevant example below, which exemplifies the schematic tonal representation in the table above (row a.).

(31) Recessive GT

- a. Unvalued /yosida + -<sup>Ⓣ</sup>si/ → \ $\text{yosid}\acute{\text{a}}\text{-si}$ \ ‘Mr. Yoshida’  
b. Valued /múráki + -<sup>Ⓣ</sup>si/ → \ $\text{m}\acute{\text{u}}\text{ráki}\text{-si}$ \ ‘Mr. Muraki’ (\*murakí-si)  
[Japanese - Kawahara 2015:468]

Parallel examples were discussed in Giphende (Hyman 2017), with two different culminativity constraints depending on the cophology of the floating tone (hence <sup>Ⓣ</sup><sub>1</sub> vs. <sup>Ⓣ</sup><sub>2</sub>). The first construction exponing focus has a word-level culminativity constraint prohibited multiple H’s, while the second exponing genitive localizes this to adjacent OCP constraint \*HH only. The schematic tonal structure illustrates that <sup>Ⓣ</sup><sub>1</sub> never docks if there is an H already present, while <sup>Ⓣ</sup><sub>1</sub> does not dock if it would be adjacent to an input H.

These types of recessive GT are easily captured under MxBM-C. The core insight is that recessive GT enforces faithfulness to the *stem* form which consists only of the target (a contained constituent). In the Japanese case in (31)b, this is faithfulness to a basemap //múráki// → \ $\text{m}\acute{\text{u}}\text{ráki}$ \. The constraints involved in this analysis are immediately below. Note that I ignore the exact morphological features representing the VI /-<sup>Ⓣ</sup>si/ ‘Mr.’, abbreviated as *M*: [...(MR.)].

(32) Ranking:

$$\left[ \begin{array}{l} \text{O}_{\text{BM}}\text{O}_{\text{MX}}(\text{T})_{[\{\text{STEM}\}]} \\ \text{CULMIN} \\ *^{\text{Ⓣ}}\text{--}\emptyset \end{array} \right] \gg \left[ \begin{array}{l} \text{IO}(\text{T}) \\ \text{O}_{\text{MX}}\text{O}_{\text{BM}}(\text{T})_{[\{F:\alpha\tau\} \{M:[\dots(\text{MR.})]\}]} \\ \text{O}_{\text{BM}}\text{O}_{\text{MX}}(\text{T})_{[\{F:\alpha\tau\} \{M:[\dots(\text{MR.})]\}]} \\ \text{O}_{\text{MX}}\text{O}_{\text{BM}}(\text{T})_{[\{\text{STEM}\}]} \end{array} \right]$$

(33) Constraint definitions:

- a.  $\text{O}_{\text{BM}}\text{O}_{\text{MX}}(\text{TONE})_{[\{\alpha\text{VI}_1\}]}$  (shorthand:  $\text{O}_{\text{BM}}\text{O}_{\text{MX}}(\text{T})_{[\{\alpha\text{STEM}\}]}$ )  
If a matrix input ( $\text{I}_{\text{MX}}$ ) and basemap input ( $\text{I}_{\text{BM}}$ ) share the same STEM – i.e.  $\{\alpha\text{VI}_1\}$ , the Vocabulary Item  $\text{VI}_1$  – then all tone structure in the basemap output ( $\text{O}_{\text{BM}}$ ) must be present in the matrix output ( $\text{O}_{\text{MX}}$ )

b. CULMINATIVITY  
In a domain D, do not have multiple tonemes of the same identity, i.e. \*T<sub>i</sub>...T<sub>i</sub>

c. \*Ⓣ--∅  
All tonemes must be docked to a TBU

d. IO(TONE)  
All tone structure in the matrix input (I<sub>MX</sub>) must be present in the matrix output (O<sub>MX</sub>)

e.  $O_{MX}O_{BM}(TONE)_{\left[ \left\{ \begin{array}{l} \overline{VI-1} \\ M: [+N] \\ F: \alpha\tau \\ P: - \\ R: - \end{array} \right\} \left\{ \begin{array}{l} \overline{VI-2} \\ M: [\dots(MR.)] \\ F: - \\ P: - \\ R: - \end{array} \right\} \right]}$  (shorthand:  $O_{MX}O_{BM}(T)_{\{F: \alpha\tau\} \{M: [\dots(MR.)]\}}$ )

If a matrix input (I<sub>MX</sub>) and basemap input (I<sub>BM</sub>) share (i) the features  $M: [\dots(MR.)]$  in the second VI (VI<sub>2</sub>), and (ii) the same number of tone-bearing units  $\tau$  in the first VI (VI<sub>1</sub>), then all tone structure in the matrix output (O<sub>MX</sub>) must be present in the basemap output (O<sub>BM</sub>)

f.  $O_{BM}O_{MX}(TONE)_{\left[ \left\{ \begin{array}{l} \overline{VI-1} \\ M: [+N] \\ F: \alpha\tau \\ P: - \\ R: - \end{array} \right\} \left\{ \begin{array}{l} \overline{VI-2} \\ M: [\dots(MR.)] \\ F: - \\ P: - \\ R: - \end{array} \right\} \right]}$  (shorthand:  $O_{BM}O_{MX}(T)_{\{F: \alpha\tau\} \{M: [\dots(MR.)]\}}$ )

If a matrix input (I<sub>MX</sub>) and basemap input (I<sub>BM</sub>) share (i) the features  $M: [\dots(MR.)]$  in the second VI (VI<sub>2</sub>), and (ii) the same number of tone-bearing units  $\tau$  in the first VI (VI<sub>1</sub>), then all tone structure in the basemap output (O<sub>BM</sub>) must be present in the matrix output (O<sub>MX</sub>)

g.  $O_{MX}O_{BM}(TONE)_{\{\alpha\overline{VI-1}\}}$  (shorthand:  $O_{MX}O_{BM}(T)_{\{\alpha\overline{STEM}\}}$ )  
If a matrix input (I<sub>MX</sub>) and basemap input (I<sub>BM</sub>) share the same STEM – i.e.  $\{\alpha\overline{VI-1}\}$ , the Vocabulary Item VI<sub>1</sub> – then all tone structure in the matrix output (O<sub>MX</sub>) must be present in the basemap output (O<sub>BM</sub>)

Notice that these constraints are of two types:  $O_{MX}O_{BM}(TONE)$  and an equivalent  $O_{BM}O_{MX}(TONE)$ . The difference is one of directionality between the outputs. The former states that all tone structure in the *matrix* output (O<sub>MX</sub>) must be present in the *basemap* output (O<sub>BM</sub>) (but not necessarily vice versa). The latter states the opposite, namely that all tone structure in the basemap output (O<sub>BM</sub>) must be present in the matrix output (O<sub>MX</sub>).

I now show a full tableau illustrating recessive GT. The matrix input (I<sub>MX</sub>) are the contents of the two vocabulary items from (31)b above, shown in (34) below.

(34) Matrix input ( $I_{MX}$ )

$$/ \left\{ \begin{array}{l} \text{Name} \\ M: [\sqrt{MURAKI}] \\ F: / \text{múraki} / \\ P: - \\ R: - \end{array} \right\} \left\{ \begin{array}{l} \text{Mr.} \\ M: [...(MR.)] \\ F: / \text{ᵀ}si / \\ P: - \\ R: O_{BM}O_{MX}(T)_{[\{\alpha_{STEM}\}]} \gg IO(\text{TONE}) \end{array} \right\} /$$

Here, the target is in red and the trigger is in black. The trigger is the suffix /-si/ with a floating high tone, and has a highly ranked constraint  $O_{BM}O_{MX}(\text{TONE})_{[\{\alpha_{VL-1}\}]}$  whose shorthand is  $O_{BM}O_{MX}(T)_{[\{\alpha_{STEM}\}]}$ .

The full Tableau 8 is below.



	$H^{\oplus} \emptyset$ / múraki sí /	$O_{BM} O_{MX}$ (TONE) [[M: aSTEM]]	CULMIN	* $(\oplus)$ $\emptyset$	IO(TONE)	$O_{MX} O_{BM}$ (TONE) [[F: aT] [[M: [...(MR.)]]]]	$O_{BM} O_{MX}$ (TONE) [[F: aT] [[M: [...(MR.)]]]]	$O_{MX} O_{BM}$ (TONE) [[M: aSTEM]]
a.	$H^{\oplus} \emptyset$ \ múraki sí \				1	1	1	
b.	$H^{\oplus} \emptyset$ \ múraki sí \			$W$ (0~1)	$L$ (1~0)	$W$ (1~2)	$W$ (1~1)	$W$ (0~1)
c.	$\oplus \emptyset$ \ murakí sí \	$W$ (0~1)			(1~1)	$L$ (1~0)	$L$ (1~0)	$W$ (0~1)
d.	$H \emptyset$ \ murakí sí \	$W$ (0~1)			(1~1)	$L$ (1~0)	$L$ (1~0)	$W$ (0~1)
e.	$H^{\oplus} \emptyset$ \ múraki sí \		$W$ (0~1)		$L$ (1~0)	(1~1)	$L$ (1~0)	$W$ (0~1)
f.	$H^{\oplus} \emptyset$ \ múraki sí \		$W$ (0~1)		$L$ (1~0)	(1~1)	$L$ (1~1)	$W$ (0~1)
g.	$\emptyset \emptyset \emptyset$ \ murakí sí \	$W$ (0~1)			$W$ (1~2)	$L$ (1~0)	$L$ (1~1)	$W$ (0~1)

$\  I_{BM} \ $	$\left\{ \begin{array}{l} \text{Name} \\ M: [\sqrt{MURAKI}] \end{array} \right\} //$ $\left\{ \begin{array}{l} F: / múraki / \\ H \\ // múraki // \end{array} \right\}$	$\left\{ \begin{array}{l} Mr. \\ M: [...(MR.)] \end{array} \right\} //$ $\left\{ \begin{array}{l} F: / \oplus si / \\ \oplus \emptyset \\ // \tau \tau \tau si // \end{array} \right\}$
$\  O_{BM} \ $	$\left\{ \begin{array}{l} H \\ // múraki // \end{array} \right\}$	$\left\{ \begin{array}{l} \oplus \emptyset \\ // \tau \tau \tau si // \\ \oplus \emptyset \\ // \tau \tau \tau si // \end{array} \right\}$

Tableau 8 – Valued target with recessive / – $\oplus$ si /

The winning candidate (a.) shows the recessive pattern where the underlying tone of the target /múráki/ remains in the output and the floating tone is deleted \múráki -si\. The losing candidates include one where the floating tone remains floating in the output (b.), a dominant case overriding the underlying tone (c.), shifting the underlying tone to the right edge of the stem (d.), two neutral patterns where both the stem H and the docked floating  $\textcircled{\text{H}}$  co-exist (e.-f.), and a subtractive-dominant pattern (g.).

As with dominant GT, the logic of recessive GT is straightforward. The constraint  $O_{\text{BM}}O_{\text{MX}}(\text{T})_{[\{\alpha\text{STEM}\}]}$  picks out the relevant projection which in this case is the stem ( $\text{VI}_1$ ), an input-output mapping //múráki//  $\rightarrow$  \múráki\\. The  $O_{\text{BM}}O_{\text{MX}}(\text{TONE})_{[\{M: \alpha\text{STEM}\}]}$  assesses whether the basemap output tone is present in the matrix output tone, which is not the case for candidates c., d., g. which are eliminated. Two markedness constraints eliminate the rest of the candidates. The first is culminativity. As stated above and throughout this study, recessive GT involves culminativity, whose effects can be seen here in eliminating candidates e.-f. with multiple H tonemes in the output. The second is  $*\textcircled{\text{T}}\text{--}\emptyset$ , which requires that all floating tones be docked, eliminating candidate b.

A  $\text{MXBM-C}$  constraint  $O_{\text{MX}}O_{\text{BM}}(\text{TONE})_{[\{F: \alpha\tau\} \{M: [\dots(\text{MR.})]\}]}$  enforces faithfulness to an abstract induced basemap \tau\tau\acute{-si\ due to the deficient projection within the constraints, but is lowly ranked and therefore does not have an effect.

I now derive recessive GT with toneless *unvalued* target-hosts, shown with the input-output mapping /yosida - $\textcircled{\text{H}}$ si/  $\rightarrow$  \yosidá-si\ ‘Mr. Yoshida’ in Tableau 9 below.



The basemap pool has an input-output mapping //yosida//  $\rightarrow$  \\yosida\\ with no tone in either form (default tone would come in at a later stage). Therefore the high-ranked constraint  $O_{BM}O_{MX}(TONE)_{\{M: \alpha STEM\}}$  is vacuously satisfied by all the matrix output candidates. Candidate b. with output floating tone is eliminated by  $*(\textcircled{T})\text{--}\emptyset$ , and unnecessary deletion of the floating tone in candidate c. is militated against by IO(TONE), as there is no culminativity violation here. Finally, candidate d. is eliminated where the floating tone docks to the trigger, and not the target which violates  $O_{MX}O_{BM}(TONE)_{\{F: \alpha T\} \{M: [\dots(MR.)]\}}$  constraint which enforces faithfulness to the second basemap in the basemap tableau.<sup>13</sup>

Further, the reason why  $O_{BM}O_{MX}(TONE)_{\{M: \alpha STEM\}}$  is ranked high but  $O_{MX}O_{BM}(TONE)_{\{M: \alpha STEM\}}$  is ranked low should now be clear. The matrix output's winning candidate \yosidá-si\ (candidate a.) has a tone in a position which is not found in the basemap output. This therefore incurs one violation of  $O_{MX}O_{BM}(TONE)_{\{M: \alpha STEM\}}$ , as shown. We can compare this to the losing candidate \yosida-si\ (c.) in which the floating tone has been deleted from the input and therefore better matches the tonal structure of the basemap output, incurring no violations of  $O_{MX}O_{BM}(TONE)_{\{M: \alpha STEM\}}$ . It is therefore crucially necessary to rank the basemap-to-matrix constraint  $O_{BM}O_{MX}(TONE)_{\{M: \alpha STEM\}}$  highly ranked and its inverse lowly ranked.

Recessive GT is provided in schema form below:

Valued target	$\begin{array}{c}   \text{MATRIX}   \\   \text{MX}   \end{array} / \begin{array}{c} \text{H} \\   \\ \text{múraki} \end{array} + \text{si} / \rightarrow \backslash \begin{array}{c} \text{H} \\   \\ \text{múraki-si} \end{array} \backslash$	‘Mr. Muraki’
	$\begin{array}{c}    \text{BASEMAP}    \\    \text{BM}    \end{array} // \begin{array}{c} \text{H} \\   \\ \text{múraki} \end{array} // \rightarrow // \begin{array}{c} \text{H} \\   \\ \text{múraki} \end{array} //$	
Unvalued target	$\begin{array}{c}   \text{MATRIX}   \\   \text{MX}   \end{array} / \begin{array}{c} \text{H} \\   \\ \text{yosida} \end{array} + \text{si} / \rightarrow \backslash \begin{array}{c} \text{H} \\   \\ \text{yosida-si} \end{array} \backslash$	‘Mr. Yoshida’
	$\begin{array}{c}    \text{BASEMAP}    \\    \text{BM}    \end{array} // \begin{array}{c} \text{H} \\   \\ \text{yosida} \end{array} // \rightarrow // \begin{array}{c} \text{H} \\   \\ \text{yosida} \end{array} //$	

Table 5: Recessive GT via MxBM-C

The blue arrow and outline indicates that the matrix input refers to a basemap input which is its morphological stem. With both types of targets, the underlying tonal structure remains the same in the basemap, valued and unvalued respectively. This tonal structure subsequently influences the matrix output with valued targets, but has *no* influence with unvalued targets. This is crucially distinct from subtractive-dominant GT which *did* show influence from an entirely toneless output. This was because with replace-dominant GT, the relevant highly-ranked constraint was  $O_{MX}O_{BM}(T)$  going from matrix to basemap, rather than from basemap to matrix.

In concluding our discussion of recessive GT, I must point out that my survey of GT found at least one case of recessive GT which does not straightforwardly involve culminativity: the Bantu language Jita (row e. in Table 4 above). Downing (1996, 2014) shows that PRESENT CONTINUOUS (PRES.CONT) verb inflection is expressed via one to two high tones. The distribution

<sup>13</sup> Alternatively, there are several markedness constraints which one may point to, but I will not go into the details of this here. In general, a floating tone docking to its sponsor is very rare and requires a study unto itself (as discussed in chapter 3 and later at the end of chapter 6). I will therefore take it for granted that floating tones dock to their neighboring TBU.

of this tonal exponence display several patterns based on the number of mora in the input, which Downing refers to as ‘chaotic patterns’ (citing Goldsmith 1987). These patterns are summarized in Table 6 below.<sup>14</sup>

	1μ	2μ	3μ	4μ (+)
a.	/ gwa /	/ liya /	/ sakira /	/ βirimira /
Unvalued	‘fall’	‘pay’	‘help’	‘run toward’
	\ kaa- <b>gwá</b> \	\ kaa- <b>liyá</b> \	\ kaa- <b>sakíra</b> \	\ kaa- <b>βírimirá</b> \
	‘s/he falls’	‘s/he pays’	‘s/he helps’	‘s/he runs toward’
b.	\ - $\text{H}$ \	\ - $\text{H}$ \	\ - $\text{H}$ \	\ - $\text{H}$ $\text{H}$ \
c.	/ <b>lyá</b> /	/ <b>βóna</b> /	/ <b>βónera</b> /	/ <b>tégeresya</b> /
Valued	‘eat’	‘see’	‘get for’	‘listen’
	\ kaa- <b>lyá</b> \	\ kaa- <b>βóna</b> \	\ kaa- <b>βónera</b> \	\ kaa- <b>tégeresya</b> \
	‘he is eating’	‘s/he sees’	‘s/he gets for’	‘s/he listens’
d.	\ -H \	\ -H $\text{O}$ \	\ -H $\text{O}$ \	\ -H $\text{O}$ $\text{O}$ \

Table 6: Recessive GT in Jita

Present continuous forms are given with the prefixal unit /kaa-/ ‘s/he Xs ~ is Xing’ in combination with 1-4 mora verb stems. Underlying toneless stems are in row a (unvalued). The tone pattern which falls on these is in row b.: 1μ and 2μ stems receive a final H tone, 3μ stems receive a penultimate H, and 4μ stems receive an initial H as well as a final H. In contrast H-toned verb stems are in row c., which bear a H on their initial mora. These do not bear special tone patterns, as shown in rows d. The fact that the [PRES CONT] grammatical tune docks to the target if it is unvalued (toneless) but does not dock to the target if it is valued (toned) is a definitional quality of recessive GT. This therefore appears to be a counterexample that recessive GT only occurs in conjunction with culminativity given that \kaa-βírimirá\ ‘s/he runs toward’ contains multiple H tones (though note that it is not an OCP adjacency violation). I will leave discussion of these Jita facts for further study, but want to note their importance here.<sup>15</sup>

<sup>14</sup> Note that I only provide the outputs in \ / slashes which are intermediate phonological forms, and not the ultimate surface forms which additionally would show rightward high tone shift. See Downing (1996, 2014) for details of this process, and also chapter 3 within this study for examples of rightward shift on the surface.

<sup>15</sup> The non-application of the grammatical tune is relative only to the value of the verb root itself. In the terminology of this study, the valuation window consists only of the verb root and not any prefixes preceding it. Consider the following data (Downing 2014:112):

- (i.) Input
- |        |         |            |            |                       |
|--------|---------|------------|------------|-----------------------|
|        | H       | $\text{H}$ | $\text{H}$ |                       |
| / kaa- | cí-     | lamurira   | /          |                       |
| kaa-   | cí-     | lamurira   |            | $\text{H}$ $\text{H}$ |
| 3SG    | 1PL.OBJ | decide     |            | PRES.CONT             |
- (ii.) Output
- H  $\text{H}$   $\text{H}$
- \ kaa-cí-lámurirá \
- ‘s/he decides for us’

The input in (i.) shows that the  $\text{H}\dots\text{H}$  grammatical allotune is conditioned by the toneless 4μ verb root /lamurira/ ‘decide’. These floating tones then dock to the edges of the verb root shown in (ii.). Important for our purposes is that the high-toned object prefix /cí-/ ‘us’ does not block the application of the grammatical tune, and that Meeussen’s Rule (otherwise active) does not apply to the output (i.e. no application of  $\text{H}\text{H} / \rightarrow \text{H}\text{O}$ ).

### 5.4.2 Neutral GT

The second type of non-dominant GT to consider is neutral GT, the most straightforward to capture. As stated in chapter 3, neutral GT always applies regardless of the value of the target (unlike recessive GT), but it does not *automatically* replace or delete target tones (unlike dominant GT). The familiar example is below from Hausa using the suffix /-<sup>Ⓛ</sup>n/ whose floating tone docks to the H-tone final stem resulting in a falling tone.

- (35) Neutral GT in Hausa
- a. /sààtáccéé + -<sup>Ⓛ</sup>n/ → \sààtáccéè\ [sààtáccè̃n] ‘the stolen one’
  - b. /zóómààyéé + -<sup>Ⓛ</sup>n/ → \zóómààyéè\ [zóómààyè̃n] ‘the hares’

Neutral GT is understood as the simple concatenation of two exponents in context. In many cases of neutral GT, the input tones will simply be preserved in the output by docking floating tones, e.g. in this Hausa case above. We expect to see cross-linguistic variation vary with respect to different phonological grammars, e.g. as below with six different potential outputs from neutral GT.

- (36) Hypothetic input / táláā + -<sup>Ⓛ</sup>kí /
- a. Neutral GT output 1: \táláā-kí\
  - b. Neutral GT output 2: \táláà-kí\
  - c. Neutral GT output 3: \tálāà-kí\
  - d. Neutral GT output 4: \táláā-<sup>4</sup>kí\
  - e. Neutral GT output 5: \tálàà-kí\
  - f. Neutral GT output 6: \táláā-kǐ\ etc.

Thus, when conflicts arise in neutral patterns, two predictions are made: (i) there is no influence based on the morphological identity of the sub-constituents to resolve the conflict, and consequently (ii) the least phonologically marked output will surface to resolve it. The strongest version of this principle is as follows, called **neutral GT conflict resolution**.

- (37) **Neutral GT conflict resolution** (strongest version): Conflicts in neutral patterns are entirely resolved via reference to phonological markedness, and never to morphological properties

There are several imaginable ways that neutral GT patterns can be resolved under conflict, including the following:

- (38) Hypothetical repairs with neutral GT
- a. **Directionality** - maintain the leftmost tone  
/ (H...H...) / → \ (H...Ø...) \
  - b. **Prominence** – maintain the stressed tone  
/ (H...<sup>1</sup>H...) / → \ (Ø...<sup>1</sup>H...) \
  - c. **Toneme hierarchy** - maintain the unmarked tone, e.g. H over M  
/ H<sup>Ⓜ</sup> / → \ H \ ; / M<sup>Ⓜ</sup> / → \ <sup>Ⓜ</sup>H \
  - d. **Consonant-tone co-occurrence**- least marked tone in context  
/ tā<sup>Ⓜ</sup> / → \ tá \ ; / dā<sup>Ⓜ</sup> / → \ dā \
  - e. **Tonotactics** - allow a surface tone if it does not violate the inventory of permitted tone shapes, e.g. <sup>ok</sup>[ML], but \*[MH]  
/ <sup>Ⓜ</sup>L / → \ <sup>Ⓜ</sup>L \ / <sup>Ⓜ</sup>H / → \ <sup>Ⓜ</sup> \ or \ H \ (but \* \ <sup>Ⓜ</sup>H \) etc.

Directionality is a common resolution in privative-culminative systems, referred to as directional resolution in the stress literature (van der Hulst 2012). One of the most famous is the ‘Basic Accentuation Principle’ in many Indo-European languages (Kiparsky & Halle 1977:209), as defined below from Yates (2017:19-20):

- (39) Basic Accentuation Principle (BAP):  
 If a word has more than one accented vowel, the leftmost of these receives word stress.  
 If a word has no accented vowel, the leftmost syllable receives word stress.

In privative-culminative tone languages, such facts are equally found. For example, consider the data from Metnyo Ambel [wgo] below, a tonal language exhibiting culminativity (Arnold 2018).

- (40)
- |    |          |               |                         |                 |                           |           |
|----|----------|---------------|-------------------------|-----------------|---------------------------|-----------|
|    |          | / áti / ‘run’ |                         | / abáj / ‘play’ |                           |           |
| a. | 1DU.INCL | / tut- /      | / tut-áti / \ tut-áti \ | [tùtáti]        | / tut-abáj / \ tut-abáj \ | [tùtábáj] |
| b. | 1PC.INCL | / tút- /      | / tút-áti / \ tút-ati \ | [tútāti]        | / tút-abáj / \ tút-abaj \ | [tútābáj] |
- [Metnyo Ambel – Arnold 2018:206]

Multiple H tones within a word are not permitted and must be resolved, e.g. when a H tone is sponsored from both the prefix and the root (row b.). In this case, the second of the two deletes, what Arnold calls ‘progressive /H/ deletion’. The result is an output with only one H tone, and the toneless TBUs are subject to default pitch realization on the surface (M or L depending on their position). In short, the leftmost H tone wins.<sup>16</sup>

A common strategy when encountering neutral GT with directional resolution is an alignment constraint e.g. ALIGN-L(PK,  $\omega$ ) (Yates 2017:22):

- (41) ALIGN-L(PK,  $\omega$ ):  
 The left edge of every stressed syllable is aligned with the left edge of the word  
 (evaluated gradiently; one violation per intervening syllable)

This constraint appeals only to phonological information (syllable, left,  $\omega$ -word), and not to morphological information. In all such neutral GT cases, no appeal is necessary to transderivational correspondence, i.e. matrix-basemap correspondence (or an equivalent morphologically-sensitive mechanism). We therefore expect all cases of neutral GT to involve markedness and IO-faithfulness constraints highly ranked, with MXBM-C constraints ranked low enough to not dictate the output, as illustrated below:

- (42) Ranking of Neutral GT:
- |  |           |  |
|--|-----------|--|
| ALIGN...<br>*[M̄H]<br>CULMIN<br>*Ⓟ--∅<br><i>etc.</i> | » IO(T) » | $O_{MX}O_{BM}(TONE)_{\{\dots\}}$<br>$O_{BM}O_{MX}(TONE)_{\{\dots\}}$<br>$O_{MX}O_{BM}(TONE)_{\{F: \alpha\} \{M: \dots\}}$<br>$O_{BM}O_{MX}(TONE)_{\{F: \alpha\} \{M: \dots\}}$ |
|--|-----------|--|

<sup>16</sup> Note that these Metnyo Ambel data as presented are also compatible with a dominant GT interpretation, in which the prefix is a dominant trigger. This is one of the thorniest issues in privative-culminative systems: whether to attribute conflict resolution to phonological or morphological factors. As it stands, this example is sufficient to illustrate conflict resolution under an interpretation that it is neutral GT.

Neutral GT across languages will not necessarily show this identical ranking of high-ranked constraints, but the MxBM-C constraints should always be sufficiently low.

## 5.5 Summary and comparison

### 5.5.1 Summary

The central insight which I sought to formalize in this chapter is that dominant GT should be characterized as a special type of paradigm uniformity effect, which I called dominance as transparadigmatic uniformity. Within paradigm uniformity effects, morphologically related words are in correspondence with one another, and as such can influence each other's form in specific contexts. With dominant GT, all outputs have a uniform tonal pattern on the target, which has the advantage of providing a more consistent cue for the trigger, but sacrifices part of the lexical contrast of the target. In contrast, with non-dominant GT outputs do not have a completely uniform form and thus maintains lexical contrast unambiguously, but at the cost of having a less delimited cue for the imperative. This trade-off can be understood as a central tension in the realization of grammatical tone.

In my formalization of dominance as transparadigmatic uniformity, I developed a novel model which expanded on the architecture of OO-Corr which I called Matrix-Basemap Correspondence (MxBM-C). Under MxBM-C, the input-output mapping being influenced is called the matrix derivation while the input-output mapping that is exerting an influence is called the basemap derivation (equivalent to the 'base' in OO-Corr literature). Dominant GT via MxBM-C is schematized in the figure below, using a familiar example from Kalabari.

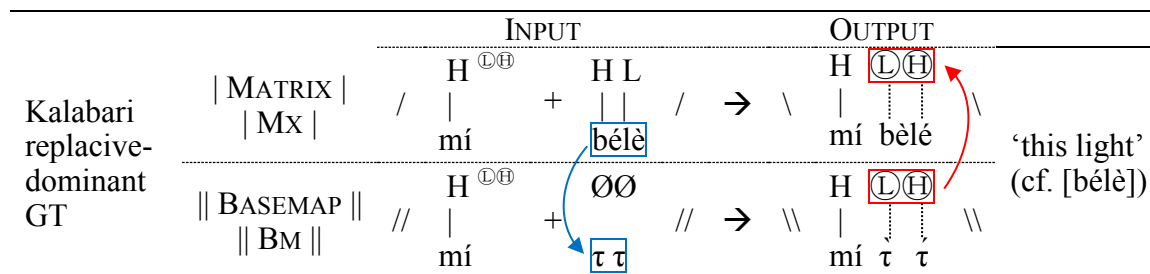

Figure 5: Replacive-dominant GT via Matrix-Basemap Correspondence (MxBM-C)

The matrix input in the top left consists of the trigger *mí* ‘this’, the grammatical tune <sup>ⓁⓂ</sup>, and the target *bé|è* ‘light’. Dominance is the result of this trigger subcategorizing for correspondence to an abstract basemap called an induced basemap, //mí<sup>ⓁⓂ</sup> + ττ// (the blue arrow in the figure). This basemap is extracted based on the common structure shared by all nouns in Kalabari, which is a toneless and abstract target form //ττ//. Because this is toneless (unvalued), the floating tones in the basemap derivation dock to it transparently without complication, resulting in a basemap output //mí ττ//. It is to this basemap output that the matrix output must remain faithful via an OO-Corr constraint  $O_{Mx}O_{BM}(TONE)$ , ranked higher than any IO-IDENT or markedness constraints (the red arrow). Although the basemap input is abstract, I adopt a principle of no basemap restriction, which can be seen as an extension of Richness of the Base forbidding restrictions on inputs.

This model analyzed all grammatical tunes as floating tones, whether they be dominant or non-dominant. This is in line with Generalized Non-Linear Affixation theory (Bermúdez-Otero 2012), whose central premise is that non-concatenative morphology can be attributed to affixation of non-segmental material, of which floating tones are but one type. However, although dominant and non-dominant GT are *representationally* equivalent, dominant GT is



crucially distinct in involving output-output constraints which enforce faithfulness to an abstract base, which goes beyond the general assumptions of Generalized Non-Linear Affixation theory.

## 5.5.2 Arguments against other models

### 5.5.2.1 Against culminativity+competition based models

Before turning to chapter 6, I argue in this final subsection against two alternative models. The first constitutes a family of models which capture dominance via **culminativity+competition**, competition being between the underlying tones of the target and the grammatical tune co-varying with the trigger. These theories are particularly popular in privative-culminative systems such as ‘pitch accent’ and stress languages. For example in Greek (a stress language - Revithiadou 1999), when an affix with inherent accent occurs with a stressless root, it maintains its stress as in (43)a. However, if the root has underlying stress, only this stress on the root surfaces and the affix accent is deleted as in b.

- (43) a. /θalas-ón/      b. /yóndol-ón/  
       [θalas-ón]        [yóndol-on]  
       sea-GEN.PL        gondola-GEN.PL

[Greek - Revithiadou 1999]

This example is a classic example of a recessive pattern. To account for these data, Revithiadou invokes a culminativity constraint in conjunction with a ‘Headmost Wins’ principle: when there is competition for a single accent, the accent of the ‘morphological head’ of the word wins, which is either a root or a derivational affix (building on earlier proposals of this type in Ralli 1988 and Ralli & Touradzidis 1992). Revithiadou’s head dominance essentially boils down to a universal constraint ranking HEADFAITH » FAITH, making prosodic dominance and ‘morphological headedness’ coextensive:

*“I propose an account that makes use of an analogous notion of hierarchically ordered preferences. However, the fundamental difference is that the hierarchy is not an idiosyncratic property of morphemes. It is imposed by the hierarchical relations between morphological constituents as these are established by morphosyntactic rules”*

[Revithiadou 1999:252]

Revithiadou’s Headmost Wins is one of several theories which seeks to account for prosodic dominance via faithfulness competition (which my model is an example of as well:  $O_{MX}O_{BM} \text{ IDENT} \gg \text{IO-IDENT}$ ). Another includes competition between **root faithfulness** vs. **affix faithfulness**.  $\text{ROOTFAITH} \gg \text{AFFIXFAITH}$  is proposed as a universal meta-constraint by McCarthy & Prince (1995), and is often cited in discussing root/affix phonological asymmetries (Beckman 1998; Ussishkin & Wedel 2002; Krämer 2006; Urbanczyk 2011; Hall et al. 2016). Others have shown the shortcomings of this as a meta-constraint and point to cases where AFFIXFAITH ranks over ROOTFAITH, e.g. Hargus & Beavert (2004) for Yakima Sahaptin [yak] affix dominance. If we allow for this parameterization, this approach would analyze dominant GT as AFFIXFAITH » ROOTFAITH and non-dominant GT as ROOTFAITH » AFFIXFAITH.

Yet another approach of this family involves **diacritic weight** (van der Hulst 2010), recent proponents including Vaxman (2016a, 2016b) for lexical accent systems generally and Kushnir (2018) for Lithuanian specifically (see also gradient symbolic representation in Smolensky & Goldrick 2016). Kushnir (2018) will suffice to exemplify this type. His central claim is that “underlying accents can be *strong* or *weak*” in Lithuanian, for both roots and affixes:

(44)		<b>Root</b>	<b>Affix</b>
a.	<b>Strong accent</b>	H <sub>1.0</sub>   /bút-/ ‘apartment’	H <sub>1.0</sub>   /-ĕ / LOC.SG
b.	<b>Weak accent</b>	H <sub>0.5</sub>   /nám-/ ‘house’	H <sub>0.5</sub>   /-ú / INSTR.SG

[Lithuanian – Kushnir 2018]

Strong accents are designated as having an ‘activity level’ of 1.0 (denoted as  $\check{\sigma}$ ), while weak accents have a level of 0.5 (denoted as  $\acute{\sigma}$ ). Kushnir invokes a culminativity constraint (“there is always only one main accent present within a phonological word”), resulting in competition between accents. Kushnir derives the surface form using these activity levels in conjunction with faithfulness constraints indexed to stem and affix (familiar to the approach above). For example, /kĕlm-aá/ with two weak accents maps to \kĕlm-aa\ ‘stump-ACC.SG’ because of higher weight stem faithfulness, but /kĕlm-aĩ/ with a strong accented suffix maps to \kĕlm-aĩ\ ‘stump-NOM.PL’.

These diverse models are unified by how they account for the origin problem and erasure problem. Prosodic units of contrast (whether stresses, accents, tonemes, etc., and whether docked or floating) originate within the underlying representation of individual lexical items, a property which they share with the model I have proposed. Where I differ is in the locus of erasure: for these alternative models, erasure is due to multiple prosodic units of contrast being banned from co-occurring within a domain. Thus, dominance is ultimately a culminativity effect where different sponsors are all vying for the same ‘slot’ in some sense and the winner is decided based on faithfulness ranking.

There are several arguments against this family of models. First are specific arguments we can level against individual models. Regarding strong versions of head and root faithfulness which assume universal meta-constraints, these models are simply not flexible enough to accommodate the range of GT patterns. Not all heads are dominant and not all non-heads are non-dominant (not to mention that the term ‘head’ is not sufficiently restrictive to make straightforward predictions in the model of the syntax/phonology interface and spell-out assumed in this study). This approach also does not say how two accented heads would interact (e.g. [OBJECT + VERB] constructions, discussed in chapters 4 and 6), nor how two non-heads would interact. Further, there are numerous cases where a trigger is dominant over a root but if that root appears with another modifier the entire resulting sequence suddenly becomes indomitable (i.e. cannot be a host to a dominant trigger – see Chapter 3). For example, in Makonde [kde] GT from a demonstrative can be hosted on a root but not another modifier (Kraal 2005):

(45)				
a.	/ntandasa a-u-nó /	→	\nta <b>ndásá áúú</b> no \	
	porridge this		‘this porridge’	
b.	/ntadasa únji a-u-nó /	→	\ntadaasa <b>únji áúú</b> no \	( <sup>x</sup> \ntadaasa <b>únji áúú</b> no \)
	porridge other this		‘this other porridge’	

[Makonde - Kraal 2005:258,261]

A demonstrative construction triggers H tone to go on the penultimate TBU of the noun and additionally results in a high tone bridge, shown in a. In contrast, when the demonstrative follows an inner modifier such as /ú-nji/ ‘other’ in b., the grammatical tune does not apply (i.e. there is no penultimate H on the previous word and thus no high tone bridge). This is the opposite of what one would expect if root faithfulness played a role. Several cases like this are

detailed in chapter 3. Particularly telling is the fact that I found no example of a dominant GT which does *not* apply to roots but which *does* apply to non-roots.

There are deeper problems which cut across all of these culminativity+competition models. The most glaring is that it is apparent that not all GT dominance effects involve culminativity. For example, Hausa has dominant and non-dominant triggers which assign a grammatical tune to the target-host, shown below.

(46)

- |    |   |   |   |
|----|---|---|---|
| a. | Dominant trigger [PLURAL] ↔ /- <sup>Ⓛ</sup> ái/ :         |   |   |
|    | / wàkííli + - <sup>Ⓛ</sup> ái /                           | → | \ wàkííli \                      ‘representatives’                          |
| b. | Non-dominant trigger [REFERENTIAL] ↔ /- <sup>Ⓛ</sup> n/ : |   |   |
|    | / jààkíí + - <sup>Ⓛ</sup> n /                             | → | \ jààkíín \                      [jààkín]                      ‘the donkey’ |
|    |   |   | [Hausa - Newman 1986:252,257]   |

The dominant trigger /-<sup>Ⓛ</sup>ái/ [PLURAL] in a. replaces the underlying tones of its target-host with an all L pattern. In contrast in b., the non-dominant-neutral trigger /-<sup>Ⓛ</sup>n/ [REFERENTIAL] does not override the underlying tones of the target-host but rather co-occurs with them, resulting in a falling contour [ɛ̃]. This difference cannot be attributed to some general restriction prohibiting a floating <sup>Ⓛ</sup> tone from docking at the edge of H toned stem (i.e. the unattested surface sequence \*wàkííli for a.), as this is actually a phonotactically permitted sequence e.g. /sàdààkíí/ ‘dowry’ (“money given by bridegroom to bride through her representative to legally bind the marriage” - Newman’s 2007:174). By whichever means the underlying tones of the target-host are deleted when the dominant trigger is present, it is not due to culminativity.

Secondly, Alderete (2001a:125-140, 2001b) develops a substantial argument against this approach to dominance. Even if it were able to handle replacive-dominance GT (which it does not), it cannot handle subtractive-dominance GT which does not even have the pretense of competition. In subtractive-dominance, there is no grammatical tune and often the trigger-sponsor itself does not even have underlying tone. Therefore there are no tones for the underlying tones of the target-host to ‘compete’ with. Such an argument has been made previously in the work on Antifaithfulness by Alderete, and presents a major challenge for proposals involving morpheme competition or strength (discussed at length in the next chapter).

### 5.5.2.2 Antifaithfulness via transderivational correspondence

The last model I will introduce and argue against is ‘Antifaithfulness’ (Alderete 2001a, 2001b).<sup>17</sup> This model of dominance shares with my model transderivational correspondence and a central role for output-output constraints. However, while they are alike in spirit, they differ substantially in details.

The central insight which Antifaithfulness seeks to capture is that dominance is due to an imperative to *not* be faithful to the underlying form, along some phonological dimension. In the privative-culminative tone system of Japanese, Alderete discusses both replacive-dominant and subtractive-dominant types, as shown below:

<sup>17</sup> See also the notion of ‘anti-correspondence’ in Hayes (1999), as discussed in Kurisu (2001).

- (47) Dominant accent
- a. Additive-dominant *-ppó*
- / abura –ppó –i / → \ abura-ppó-i \ ‘oily’
- / adá – ppó – i / → \ ada-ppó-i \ ‘coquettish’
- / kiza –ppó –i / → \ kiza-ppó-i \ ‘affected’
- b. Subtractive-dominant *-kko*
- / edo –kko / → \ edo-kko \ ‘native of Tokyo’
- / kóobe –kko/ → \ koobe-kko \ ‘native of Kobe’
- / nyuuyóoku –kko/ → \ nyuuyooku-kko \ ‘native of New York’
- [Japanese – Alderete 2001b:217]

In both types, the tone of the stem is deleted, with subtractive-dominant /-kko/ showing that this deletion cannot be attributed to culminativity. To account for these data, Alderete (2001b:218) posits an Antifaithfulness constraint, indicated by the negation sign  $\neg$  before the constraint.

- (48)  $\neg$ OO-MAX(Accent)
- For  $x$  an accent,  $\neg[\forall x \exists x' [x \in S_1 \rightarrow x' \in S_2 \ \& \ x \mathcal{R} x' ]]$
- (‘it is not the case that every accent in  $S_1$  has a correspondent in  $S_2$ ’)

The output-output correspondence relation here is between a matrix output \koobe-kko\ and a base output \kóobe\, the output of the form in isolation. Essentially, this constraint states that the matrix output must *not* have an accent which is present in the basemap output, hence ‘anti’-faithfulness. For every faithfulness constraint, there is an equivalent Antifaithfulness constraint, subject to a relative ranking (and in Alderete’s model indexation to morphemes).

How this cashes out is given in the tableau below. Note that I update the tableau to include terms basemap and matrix with their bracketing conventions, not in the original.

Basemap	Matrix / kóobe –kko /	$\neg$ OO-MAX(Accent)	IO-DEP(Accent)	HAVEACCENT
\kóobe\	a. \kóobe-kko\	*!		
\kóobe\	b. \koobé-kko\		*!	
\kóobe\	c. $\emptyset$ \koobe-kko\			*

Tableau 10: Subtractive-dominant via Antifaithfulness (Alderete 2001b:219)

Candidate a. is fully faithful to the basemap output \kóobe\ and therefore violates the Antifaithfulness constraint  $\neg$ OO-MAX(Accent), while candidate b. is not faithful to this basemap output but inserts an accent not in the input violating IO-DEP(Accent). The winner therefore is candidate c. with no accent, which violates the lowly-ranked HAVEACCENT<sup>18</sup> (latter valued via Japanese-specific default surface rules). Thus under Alderete’s system, Antifaithfulness constraints provide a simple typology resulting in dominant and non-dominant patterns:

- (49)
- a. Dominant affixes:  $\neg$ OO-MAX-PROM » OO-MAX-PROM
- b. Non-dominant affixes: OO-MAX-PROM »  $\neg$ OO-MAX-PROM

<sup>18</sup> I use this placeholder constraint HAVEACCENT rather than Alderete’s name for this constraint (“CULMINATIVITY”), to avoid confusion about the definition of this latter term.

Like the culminativity+competition based models, we can level a number of arguments against Antifaithfulness. First, one motivation for couching Antifaithfulness in terms of output-output rather than input-output correspondence is to capture the fact that affixes can be dominant but roots cannot, Alderete's 'strict base mutation' principle equivalent to the dominant GT asymmetry presented in chapter 3. An affix can idiosyncratically trigger Antifaithfulness of a root (or stem) such as in Tableau 10, but the opposite is not found. Alderete correlates this asymmetry with the fact that roots can appear as true outputs in isolation, e.g. an output \\kóobe\\ in the Japanese tableau above, but affixes cannot, e.g. there is no output \\-kko\\ in Japanese with the suffix in isolation.

However, this is problematic as soon as we look at phrase-level GT. I stressed in the typology part of this study (Part I) that dominance effects in GT apply both at the word-level and phrase-level in very similar ways. Even under strict views of OO-Corr such as Alderete's (who adopts the traditional criteria defining a base as detailed above in section 5.2.4), a modifier such as an adjective or demonstrative should be able to appear in isolation as a real output. Alderete's Antifaithfulness model as he envisions it cannot handle these cases.

Further, the locus of erasure in Antifaithfulness is attributed to -OO constraints triggered by dominant affixes, but Alderete specifically attributes the locus of origin of the grammatical tune to what he calls 'grammar dependence':

*“morpho-accentual processes are grammar-dependent in the sense that the changes they instantiate depend on the larger constraint system governing accent”*

[Alderete 2001b:245]

According to Alderete, what this means is that “dominant affixes trigger a deletion” but that “it is the rest of the grammar which determines the structure resulting from this deletion” (p. 222). For example,

*“several aspects of the alternation, e.g. its location, its structural change and blocking effects, are not specified by the [Transderivational Antifaithfulness] constraint and are thus determined by the ambient phonology. [Transderivational Antifaithfulness]-induced [Morphophonological operations] therefore bring about default structures (see Alderete et al. 1999) and obey the canonical faithfulness properties of the structures involved.”*

[Alderete 2001b:214]

In short, for Alderete the resulting structure is *not* due to morphological idiosyncrasy but due to general phonology. In terms of grammatical tone, the resulting grammatical tune which appears on the trigger would always be attributed to a 'default structure', as stated in the quote above.

From a cursory look at the breadth of GT patterns, we can see why this facet is problematic. In Kalabari, there are numerous grammatical tunes depending on the replacive-dominant trigger (e.g. L, HL, H<sup>+</sup>H, LH), which is a common situation for the GT-rich languages of Africa. This shows right away that we are not dealing with a single default structure. Criticism of this form has come from numerous commenters on many sides of the theoretical spectrum, e.g. Inkelas & Zoll (2007) and more recently Gouskova & Linzen (2015:450) who state that Antifaithfulness “predicts that in cases where the dominant suffix is itself unaccented, the stress pattern should revert to a single default”.

I ultimately ascribe Alderete's insistence on 'grammar dependence' to the types of prosodic systems he was examining, mostly privative-culminative systems with only one primary stress or high tone per domain (and in tone systems a privative H vs. Ø distinction) (e.g. Alderete's 2001b:222-223 table showing perfect correlation between the result of unaccented dominant affixes and default prosody). In a privative-culminative system, there is often only one accent

that can be deleted under Antifaithfulness, making these systems indiscriminate between minimal deletion and maximal deletion.

We see in GT, however, that more often than not the target undergoes maximal deletion whereby all of its underlying tones are deleted, not just one. The definition of the Antifaithfulness constraint  $\neg$ OO-MAX(Accent) in (48) states that “it is not the case that every accent in  $S_1$  has a correspondent in  $S_2$ ”, which would be satisfied if only *one* accent (or in this case toneme) were deleted. Therefore, if we were to adopt Antifaithfulness there would be egregious deletion of prosodic structure in almost every case, which would be left explained.

In short, Antifaithfulness predicts *minimal* non-identity between the matrix output and basemap output (e.g. deleting of a *single* toneme), whereas my model of dominance as transparadigmatic uniformity predicts *maximal* non-identity between the outputs, which is largely upheld in the typology established in the previous part I.

# **Chapter 6**

## **Cophonology-scope**

## 6.1 Relevant background: Spell-out and spell-out operations

This section 6.1 and the next section 6.2 summarize essential components of the syntax/phonology interface, as laid out in chapter 4. Most important will be spell-out, vocabulary insertion, and hierarchy exchange, and how they establish cophonology-scope. If the reader feels they have a firm grasp on these details from that chapter already, they may skip these sections and turn to the account of GT in 6.3.

### 6.1.1 Spell-Out

As established in Chapter 4, I adopt a strictly feed-forward, modular view in which syntax generates structure in a separate **morpho-syntactic module** ( $\approx$ syntax), and then feeds this generated structure to a separate **morpho-phonological module** ( $\approx$ phonology). Each of these modules has a separate set of primitives and combinatorics, and distinct ways in how they are restricted. These modules are connected to one another by a process called **spell-out** which translates syntactic structure into an object which is readable by a morpho-phonological grammar. In the figure below, spell-out is envisioned as the mapping of a syntactic image (/S/) to a phonological image (\Z\).

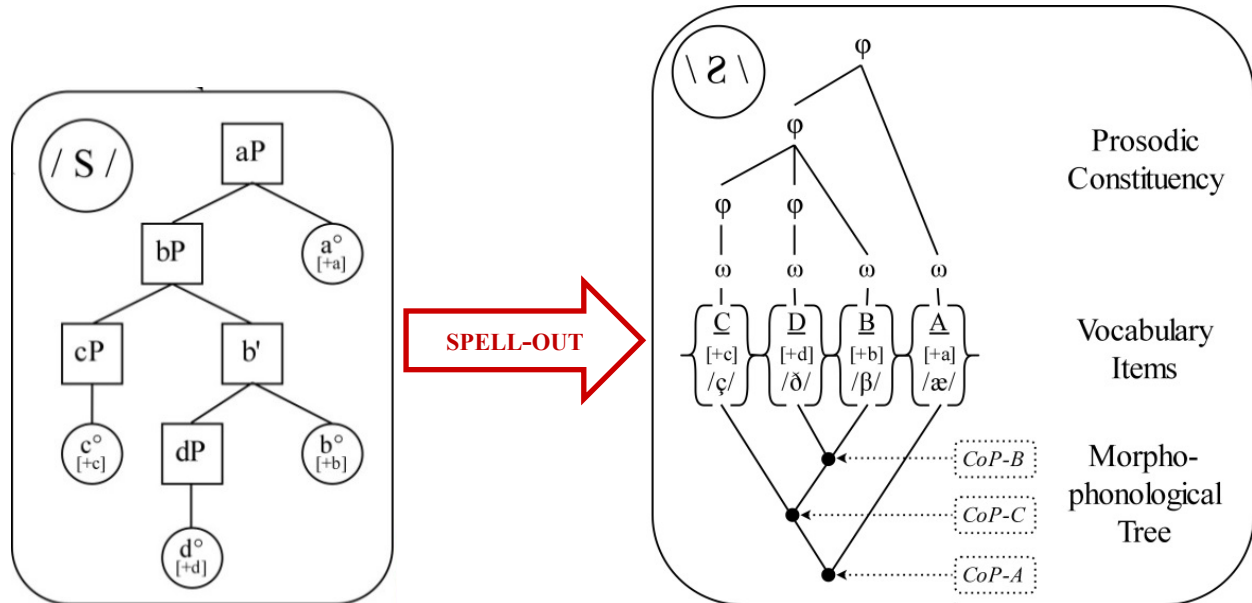

Figure 1: Spell-out as a mapping of a syntactic image /S/ to a phonological image \Z\

Spell-out as presented in this figure is composed of a number of operations. These include at the very least the following operations: **vocabulary insertion, linearization, prosodification, and hierarchy exchange**. As a whole, spell-out can be conceptualized as the **actuation of phonology** in a derivation.

(1)	<u>Spell-out operation</u>	<u>Provides</u>
a.	Vocabulary insertion	Phonological material
b.	Linearization	Phonological precedence
c.	Prosodification	Phonological constituency
d.	Hierarchy exchange	Phonological operation scope

These are defined as in below (from chapter 4).



- (2) Spell-out operations
  - a. **Vocabulary insertion:** Insertion of vocabulary items with phonological material (i.e. phonological exponents), from the vocabulary list
  - b. **Linearization:** Establishing linear precedence relations for each vocabulary item
  - c. **Prosodification:** Establishing prosodic constituency between the vocabulary items
  - d. **Hierarchy exchange:** Exchanging syntactic hierarchical relations (the syntactic tree) for morpho-phonological hierarchical relations (the morpho-phonological tree)

For each bundle of phonological units of contrast, the spell-out operation linearization establishes linear precedence relations, also seen in the figure above (the order of { } objects in a row). Above these units is prosodic constituency, established by prosodification. This involves categories common to prosodic inquiry such as syllables ( $\sigma$ ), phonological words ( $\omega$ ), phonological phrases ( $\varphi$ ), etc., as established by various phonological phenomena (Selkirk 1984). As noted in chapter 4, it may come as a surprise that prosodic constituency is largely orthogonal to grammatical tone patterns, and as such I do not devote much time to it in this study. Simply put, the distribution of grammatical tone for the most part does not make reference to prosodic constituency.

The other two spell-out operations are crucial to understanding this analysis of grammatical tone: the DM operation vocabulary insertion, and an operation innovated in this study hierarchy exchange. I provide a synopsis of these operations below; refer to chapters 4 and 5 for further details.

### 6.1.2 Vocabulary insertion

The function of vocabulary insertion is to provide phonological material, i.e. the strings of phonemes, tonemes, etc. associated with a particular meaning. Let us go into some details of what this entails.

As seen in Figure 1 above, phonological material is ‘housed’ within vocabulary items. These vocabulary items are pre-built objects which are stored in a list called vocabulary (Halle & Marantz 1993). During spell-out, the morpho-syntactic feature bundles are matched and replaced by an appropriate vocabulary item, subject to various DM principles (e.g. the Subset Principle – Halle & Marantz 1993:122, Embick 2015:95). Within DM terminology, this is referred to as ‘late insertion’ of phonological material, and is why DM is understood as a realizational model of morphology (see Stump 2001 for realizational vs. non-realizational models of morphology).

Vocabulary items have complex internal structure. I broadly follow Sande & Jenks (2017) in positing that VIs minimally consist of the content in (3). I modify their representation to include a VI label and morphosyntactic content ( $M$ ).

- (3) Content of vocabulary items (VIs)
  - a. VI label: Unique name of the VI (for identificational purposes only)
  - b. Morphosyntactic content ( $M$ ): Morphological features (paired to morphosyntactic/SynSem features in the syntax)
  - c. Featural content ( $F$ ): Tonal or segmental features
  - d. Prosodic content ( $P$ ): Prosodic selection or subcategorization
  - e. A constraint subranking ( $R$ ): A partial constraint ranking, which overrides a default master constraint ranking

The conventional representation of the internal structure of VIs is below.

(4) Vocabulary item structure:

$$\left\{ \begin{array}{l} \text{VI label} \\ M: [+F] \\ F: /-x/ \\ P: (\textcircled{\text{ }} (\textcircled{\text{ }} \dots) \text{ \_}) \\ R: C_2 \gg C_3 \gg C_1 \end{array} \right\}$$

In this hypothetical example, this VI is inserted when the morphosyntactic context is [+F] (in *M*). The VI consists of a phonological sequence /-x/ (*F*) which selects a prosodic word and must also occur in a prosodic word (in *P*). Finally, this VI imposes a constraint ranking  $C_2 \gg C_3 \gg C_1$  in the relevant domain (*R*), overriding any default constraint order. I frame this within Cophonology Theory, introduced properly below in section 6.2.

In chapter 5, I established that VIs were triggers of dominance by being associated with a special cophonology, namely a highly ranked Mx<sub>BM</sub>-C constraint in their ranking *R*. This enforces faithfulness to an abstract basemap which bears the grammatical tune pattern. For example, in the Kalabari case of replacive-dominant GT (/mí<sup>Ⓣ</sup>/ ‘this’ + /bélè/ ‘light’ → \mí bèlè\), the trigger /mí/ has a highly ranked Mx<sub>BM</sub>-C constraint in *R* which enforces correspondence to an abstract basemap \mí ṛ́\.

(5) Content of dominant GT trigger /mí/ ‘this’

$$\left\{ \begin{array}{l} \text{Demonstrative} \\ M: [\text{DEM}][\text{NEUT}] \\ F: / \text{mí}^{\text{Ⓣ}} / \\ P: - \\ R: \text{Mx}_{\text{BM}} \gg \text{IO}(\text{TONE}) \end{array} \right\}$$

In my formalization of dominance as transparadigmatic uniformity, the relevant constraint was  $O_{\text{MX}}O_{\text{BM}}(\text{TONE})$  ranked higher than any IO-IDENT or markedness constraints.

This model analyzes all dominant tone as floating tones (as in *F* in (5)), in line with Generalized Non-Linear Affixation theory (Bermúdez-Otero 2012), whose central premise is that non-concatenative morphology can be attributed to affixation of non-segmental material. Considering all GT types (dominant and non-dominant), this analysis results in the following minimal typology:

(6)	GT Type	Floating tone	Special cophonology
a.	Replacive-dominant	Yes	Yes
b.	Subtractive-dominant	No	Yes
c.	Non-dominant	Yes	No

### 6.1.3 Hierarchy exchange

Let us return to the diagram in Figure 1 repeated below, where the syntactic tree is at the left (/S/) and the resulting morpho-phonological tree is to the right (\Z\).

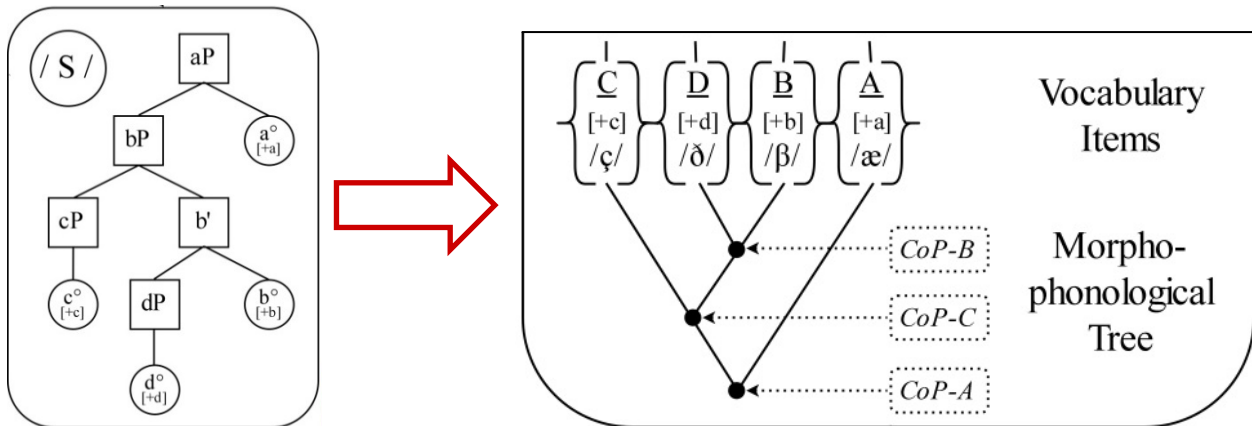

Figure 2: Morpho-phonological tree (the result of hierarchy exchange)

Using this figure we can now explore another issue: operation scope. Taking the VIs present in the middle of the phonological image at the right, a fuller schematic representation of these VIs might be the following:

(7) Hypothetical full structure of vocabulary items present in Figure 1:

$\left. \begin{array}{l} \underline{\text{C}} \\ M: [+c] \\ F: /ç/ \\ P: - \\ R: C_1 \gg C_3 \gg C_2 \end{array} \right\}$	$\left. \begin{array}{l} \underline{\text{D}} \\ M: [+d] \\ F: /ð/ \\ P: - \\ R: C_2 \gg C_1 \gg C_3 \end{array} \right\}$	$\left. \begin{array}{l} \underline{\text{B}} \\ M: [+b] \\ F: /β/ \\ P: - \\ R: C_3 \gg C_2 \gg C_1 \end{array} \right\}$	$\left. \begin{array}{l} \underline{\text{A}} \\ M: [+a] \\ F: /æ/ \\ P: - \\ R: C_2 \gg C_3 \gg C_1 \end{array} \right\}$
--	--	--	--

Each of these VIs has content in *M* which is paired to syntactic features, phonological content in *F*, and a constraint ranking they impose in *R*. However, all four of the VIs have distinct constraint rankings. Assume for this language that the default constraint ranking for the phonology is  $C_1 \gg C_2 \gg C_3$ . Each one of these VIs deviates from this default ranking as seen in *R*, overriding any default setting (for example, VI  $\{\underline{\text{C}}\}$  has a ranking  $C_1 \gg C_3 \gg C_2$ ). This naturally leads to the following question: when VIs have conflicting constraint rankings, which one wins?

In chapter 4, I proposed the following: each vocabulary item has cophonology-scope as determined by the morpho-phonological tree in a cyclic inside-out fashion, whose primary determinant is syntactic c-command. The spell-out operation which mediates this relation is called **hierarchy exchange**, defined as the following:

(8) **Hierarchy exchange**: Exchanging syntactic hierarchical relations (the syntactic tree) for morpho-phonological hierarchical relations (the morpho-phonological tree)

Informally, this operation exchanges syntactic notions of ‘upward’ and ‘downward’ for morphological notions of ‘outward’ and ‘inward’. The main function of hierarchy exchange is to establish the scope of phonological operations, which I call **cophonology-scope** (an extension of ‘stem scope’ in cophonology theory discussed below). In the tree, individual nodes connecting vocabulary items are denoted with *CoP* standing for cophonology-scope.

Before turning to that, let us first illustrate how syntactic configurations are mapped via hierarchy exchange, as shown in the table below.

Syntactic configuration		Morpho-phonological tree
a.	Head-Comp [ <sub>bP</sub> [ <sub>dP</sub> d° ] b° ]	$  \begin{array}{c}  \text{B} \\  / \quad \backslash \\  \{\underline{\text{D}}\} \{\underline{\text{B}}\}  \end{array}  $
b.	Spec-Head [ <sub>bP</sub> [ <sub>cP</sub> c° ] [ <sub>b'</sub> [ <sub>dP</sub> ...] b° ] ]	$  \begin{array}{cc}  \text{i.} & \text{C} & \text{ii.} & \text{C} & \text{B} \\  & / \quad \backslash & &   &   \\  & \{\underline{\text{C}}\} \{\underline{\text{B}}\} & & \{\underline{\text{C}}\} & \{\underline{\text{B}}\}  \end{array}  $

Table 1: Hierarchy exchange

In the syntactic configuration, sisters b° and dP form a head-complement (comp) configuration (the most deeply embedded structure). Head-comp configurations (row a.) are mapped to a morpho-phonological tree in which the VI {D} is inner (corresponding to the head of the complement) and the VI {B} is outer (corresponding to the head), labeled as B. It is always the outermost VI which labels the node.

Furthermore, row c. involves a specifier-head (spec-head) relation, where cP is in the specifier position of bP. Here, hierarchy exchange can map the spec-head configuration in two ways. In one (i.), the two VIs form a single unit united just as in the head-comp/head-head configurations. In this type, the VI which is in specifier position dictates the label of the entire unit, which in this case is labelled C. Thus the specifier is considered ‘outer’ and the head is considered ‘inner’ in this morpho-phonological tree. In the other type (ii.), both the specifier VI {C} and the head VI {B} are mapped separately and do not form any unit. Neither of them is considered outer compared to the other. It is type (i.) which will concern us in this chapter.

As established in chapter 4, the spell-out operation hierarchy exchange is sensitive to **asymmetrical c-command**. I follow Kayne’s (1994) definition of c-command which we will use in this study.

- (9) Definition of c-command (Kayne 1994:18):  
*X c-commands Y iff X and Y are categories and X excludes Y and every category that dominates X dominates Y*

Kayne (1994) presents a theory of Antisymmetry whose central tenet is the ‘Linear Correspondence Axiom’: the linear order of terminal nodes in a syntactic tree is determined strictly by their c-command relations. He posits that the linear word order [Spec-Head-Comp] is universally derived from c-command relations: heads c-command their complements and specifiers c-command the head-comp constituent.

Although I do not adopt this analysis of linearization, I use the same logic to ascribe the ultimate source of phonological operation scope to c-command. By invoking c-command, this model follows a long lineage of approaches to the syntax/phonology interface which have capitalized on this central syntactic notion in accounting for morphophonological phenomena (Kaisse 1985; Kayne 1994; Holmberg and Odden 2008; McPherson 2014; McPherson & Heath 2016; a.o.). This model most closely resembles that of McPherson (2014) in that the ultimate empirical content justifying interface design is grammatical tone. However, while McPherson’s work (and that of many others) constitutes a direct reference theory, the one posited here is diagnosed as an indirect reference theory, mediated by hierarchy exchange. I refer the reader to Chapter 4 for reasoning behind the choice of an indirect reference model. In short, this allows us the strictest type of modularity where syntactic and phonological modules are *only* mediated via spell-out and cannot otherwise access each other’s contents, while allowing for instances of non-isomorphy between syntax and phonology such as bracketing paradoxes

## 6.2 From hierarchy exchange to cophonology-scope

Having established the mechanics of hierarchy exchange, let us fully explicate its function: hierarchy exchange establishes the ‘scope’ of phonological operations which I refer to as cophonology-scope.

### 6.2.1 Cophonology Theory (CPT)

Grammatical tone is part of a substantial body of data showing phonological operations applying only in the context of a subset of morphemes and morphosyntactic constructions, classified as **morphologically-conditioned phonology**. One prominent account of this phenomenon is **Cophonology Theory (CPT)**. A noted advantage of CPT is its ability to integrate morphologically-conditioned phonology in the same theory as non-concatenative/process morphology (Inkelas 2014:80).

In the original work in CPT, researchers captured morphologically-conditioned phonology by associating each morphological constituent with a fully general phonological grammar (Orgun 1996; Anttila 1997, 2002; Inkelas 1998; Orgun & Inkelas 2002, Inkelas & Zoll 2005, 2007; a.o.). For example, in Turkish some affixes trigger glide-insertion to repair vowel hiatus such as /-undʒa/ ADVERBIAL in (10)a, while other affixes trigger vowel deletion such as /-ujor/ PROGRESSIVE in (10)b.

#### (10) Cophonologies with distinct rankings

##### a. Insertion

/anla-ma-undʒa/	[anlam <u>aj</u> undʒa]
‘understand-NEG-ADV’	*VV » MAX-V » DEP-C

##### b. Deletion

/anla-ma-ujor/	[anlam <u>u</u> ujor]
‘understand-NEG-PROG’	*VV » DEP-C » MAX-V

[*Turkish* – Inkelas & Zoll 2007:135]

From these data, we can see the same input sequence /...a-u.../ is mapped to an output \...aju...\  
or \...u...\  
depending on morphological context. We can understand these as involving two different cophonologies associated with the morphological context, Cophonology A (*CoP-A*) and Cophonology B (*CoP-B*) respectively, with different ranking of DEP-C and MAX-V (Inkelas & Zoll 2007:137).

A major advantage of Cophonology theory is that it is intrinsically cyclic, and therefore captures the many **cyclic effects** in the literature. Cyclic effects in the morpho-phonological module manifest in several ways. One is through obligatory inheritance, i.e. that ‘later evaluations [are forced] to inherit the results of earlier ones’ (Steriade 2012:4). In short, an outer cycle cannot halt an inner cycle from operating.

As stated, cyclicity is an intrinsic component of CPT, and evidence that cophonology application takes place cyclically at each node is well-supported (Inkelas 2014:200). Cyclic application is schematized in the figure below.

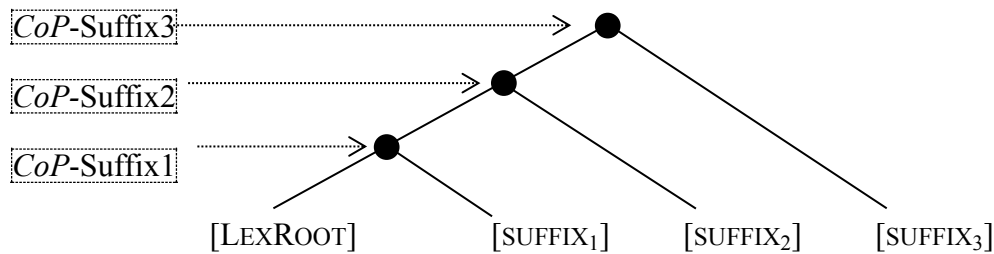

Figure 3 – Morphological structure of [ [ [ [LEXROOT]-SUFFIX<sub>1</sub>]-SUFFIX<sub>2</sub>]-SUFFIX<sub>3</sub> ]

Within a morphological constituent, it is generally assumed across theoretical frameworks that the lexical root is most deeply embedded and other morphemes are layered above them. At each node of the tree, a fully generally cophonology applies cyclically inside-out. We can call these cophonologies *CoP-Suffix1*, *CoP-Suffix2*, and *CoP-Suffix3*.

Morphological structure is thus subject to what Inkelas & Zoll (2007:144) call **stem scope**.

- (11) **Stem scope**: the scope of morphologically conditioned phonology is the stem formed by the word-formation construction in question

In the figure above, consider a cophonology associated with SUFFIX<sub>2</sub>. The principle of stem scope dictates that it will scope over the subconstituent [ [ [LEXROOT]-SUFFIX<sub>1</sub> ]-SUFFIX<sub>2</sub> ] and thus affect the items LEXROOT, SUFFIX<sub>1</sub>, and SUFFIX<sub>2</sub>. It does not and cannot scope over SUFFIX<sub>3</sub>.

### 6.2.2 Cophonology-scope (*CoP-scope*)

The definition of stem scope invokes the notion of ‘word-formation construction’. CPT has traditionally been envisioned as directly linked to word formation within lexicalist morphological theories such as Sign-Based Morphology (Orgun 1996) or Optimal Construction Morphology (Caballero & Inkelas 2013). As stated in Chapter 4, I divorce this aspect from CPT by combining it instead with Distributed Morphology (Halle & Marantz 1993; Embick & Noyer 1999, 2001; a.o.). Under this implementation, the vocabulary items themselves are the triggers of the cophonologies. The definition of stem-scope is thus modified as **cophonology-scope (*CoP-scope*)** defined below:

- [Def 1] **Cophonology-scope (*CoP-scope*)**: the scope of the cophonology ranking *R* which is associated with a vocabulary item {VI} is the constituent formed by {VI} with all inwardly located structure

To exemplify *CoP-scope*, let us return to the morpho-phonological tree:

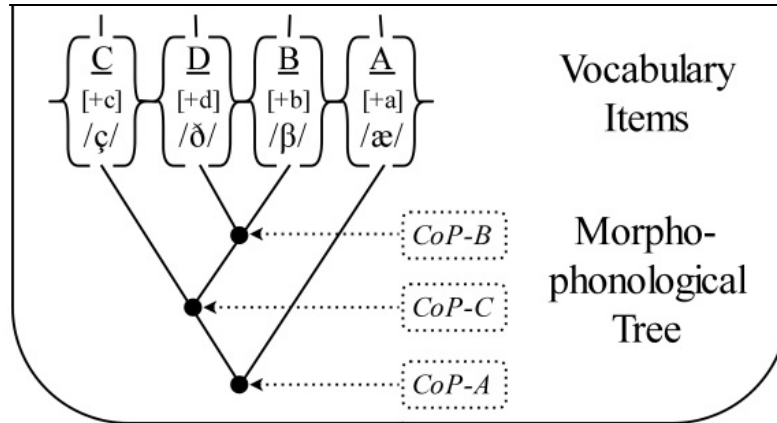

Figure 4: *CoP*-scope within the morpho-phonological tree

A table below illustrates head-comp and spec-head configurations based on this figure, complete with cophonology scope, which we abbreviate with the symbol  $\phi$ .

Syntactic configuration	Morpho-phonological tree	Cophonology-scope
Head-Comp [ <sub>bp</sub> [ <sub>dp</sub> d° ] b° ]	$\begin{array}{c} \text{B} \leftarrow \\ / \quad \backslash \\ \{\underline{\text{D}}\} \quad \{\underline{\text{B}}\} \end{array}$	<i>CoP</i> -B: $\{ \underline{\text{B}} \} \phi \{ \underline{\text{D}} \}$
The VI { <u>B</u> } that b° maps to has cophonology-scope over the VI { <u>D</u> } that d° maps to		
Spec-Head [ <sub>bp</sub> [ <sub>cp</sub> c° ] [ <sub>b'</sub> [ <sub>dp</sub> ... ] b° ] ]	$\begin{array}{c} \text{C} \leftarrow \\ / \quad \backslash \\ \{\underline{\text{C}}\} \quad \{\underline{\text{B}}\} \end{array}$	<i>CoP</i> -C: $\{ \underline{\text{C}} \} \phi \{ \underline{\text{B}} \}$
The VI { <u>C</u> } that c° maps to has cophonology-scope over the VI { <u>B</u> } that b° maps to		

Table 2: From hierarchy exchange and cophonology-scope

Head-comp configurations are mapped to a morpho-phonological tree in which the VI {D} is inner (corresponding to the head of the complement) and the VI {B} is outer (corresponding to the head). Spec-head configurations are mapped similarly. This table shows that in head-comp configurations, the outer VI has cophonology-scope over anything located ‘inwardly’. Thus, the VI {B} has cophonology-scope over {D} ( $\{\underline{\text{B}}\} \phi \{\underline{\text{D}}\}$ ), and likewise  $\{\underline{\text{C}}\} \phi \{\underline{\text{B}}\}$ . In the figure, the VI {B} subcategorizes for a specific cophonology (*CoP*-B), which scopes over both the VIs {B} and {D}. This is true moving outward in the tree, such that *CoP*-A (associated with VI {A}) has cophonology-scope over all four VIs {C} {D} {B} {A}.

Taken together, we have what I call the *CoP*-scope hierarchy, shown below. This is simply a schematic representation, as cophonologies do not literally refer to these syntactic positions under the indirect reference model here.

(12) ***CoP*-Scope Hierarchy**

- a.  $\left( \begin{array}{c} \{\underline{\text{Specifier}}\} \\ \dots \end{array} \right) \phi \left( \begin{array}{c} \{\underline{\text{Head}}\} \\ \dots \end{array} \right) \phi \left( \begin{array}{c} \{\underline{\text{Complement}}\} \\ \dots \end{array} \right)$
- b.  $\left( \text{CoP-Spec} \right) \phi \left( \text{CoP-Head} \right) \phi \left( \text{CoP-Complement} \right)$

This should be interpreted as the following: (i) the VI which corresponds to a specifier position has cophonology-scope over the VI which corresponds to its containing XP’s head, and (ii) this latter VI itself has cophonology-scope over the VI which corresponds to its complement.

### 6.3 Dominant GT via *CoP*-scope

Let us now see how cophonology-scope is used to model dominance effects in grammatical tone. In examining the triggers and targets of dominant GT, we established the **dominant GT asymmetry**.

- (13) **Dominant GT asymmetry**: within a multi-morphemic constituent, the dominant trigger is a dependent, and the target is a lexical head or a dependent structurally closer to the lexical head

We framed this asymmetry in the typological terms ‘lexical head’ of a phrase (e.g. N of NP, V of VP) and ‘dependent’ which includes affixes and modifiers (Nichols 1986). Thus in many cases, the trigger will be a grammatical item and the target will be a lexical item. No such trigger/target asymmetry exists for non-dominant GT. I summarize this below.

Trigger → Target		GT type	Non-dominant (e.g. docking)	Dominant (e.g. replacive)
<b>Grammatical/Dependent</b>	→	<b>Lexical/Head</b>	✓ Yes	✓ Yes
a. Affix	→	Root	✓ Yes	✓ Yes
b. Affix <sub>OUT</sub>	→	[Affix <sub>IN</sub> -Root]	✓ Yes	✓ Yes
c. Modifier	→	Noun	✓ Yes	✓ Yes
d. Modifier <sub>OUT</sub>	→	[Modifier <sub>IN</sub> Noun]	✓ Yes	✓ Yes
e. Object	→	Verb	✓ Yes	✓ Yes
<b>Lexical/Head</b>	→	<b>Grammatical/Dependent</b>	✓ Yes	* No
f. Root	→	Affix	✓ Yes	* No
g. Affix <sub>IN</sub>	→	Affix <sub>OUT</sub>	n/a	* No
h. Noun	→	Modifier	✓ Yes	* No
i. Modifier <sub>IN</sub>	→	Modifier <sub>OUT</sub>	n/a	* No
j. Verb	→	Object	✓ Yes	* No

Table 3: Summary of the dominant GT asymmetry

Row a. shows that if the trigger of the tonal pattern is an affix (such as a functional head) and the target is a lexical root, then the pattern can be either dominant or non-dominant. If the trigger and target are flipped (row b.), then only the non-dominant pattern is found. Notice in rows g. and i. that inner affixes and modifiers which assign non-dominant tone to an outer element are missing (marked n/a for ‘not available’), as introduced in Chapter 3. It is yet to be determined whether this is an accidental gap or not.

This table falls out naturally in the model sketched here involving syntactic positions, hierarchy exchange, and cophonology-scope. For a spec-head-comp configuration, hierarchy exchange maps specifier VIs to the outermost position and complement VIs to an innermost position. Let’s see how this works using Inkelas’ (1998) analysis of Hausa dominant GT as our starting point (updated to fit this study’s terminology). The now familiar Hausa example is repeated below (see chapter 3 for details):



- (14) Dominant GT in Hausa
- |            |         |                                      |   |                    |
|------------|---------|--------------------------------------|---|--------------------|
| a. Cycle 1 | Dom     | / [kàràntá] - <sup>Ⓛ</sup> íí /      | → | \ kàràncíí \       |
| b. Cycle 2 | Non-dom | / má- [kàràncí] /                    | → | \ mákàràncíí \     |
| c. Cycle 3 | Dom     | / [mákàràncíí] - <sup>Ⓢ</sup> iyáá   | → | \ mákàràncííiyáá \ |
| d. Cycle 4 | Non-dom | / [mákàràncíiyáá] - <sup>Ⓛ</sup> r / | → | \ mákàràncíiyáár \ |

Each node in the morpho-phonological tree represents a cycle where a fully general cophonology applies, triggered by the outermost element, in each of these cases being an affix. This tree is shown below.

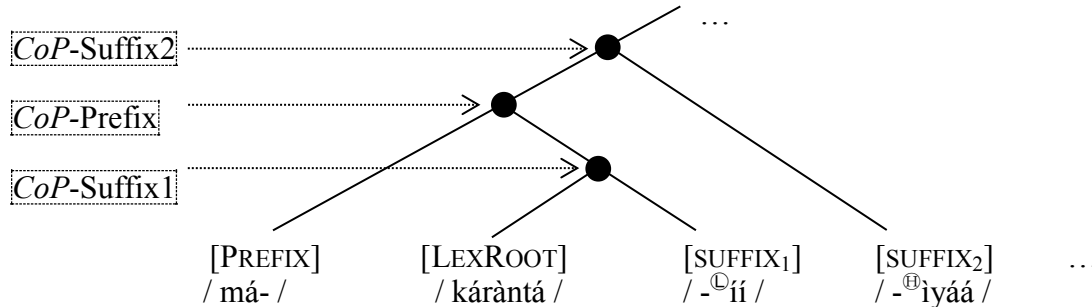

Figure 5: Morpho-phonological tree (Hausa - Inkelas 1998)

The first cophonology *CoP-Suffix1* applies to the subconstituent [LEXROOT SUFFIX<sub>1</sub>] and is triggered by the suffix /-<sup>Ⓛ</sup>íí/. This is a replacive-dominant pattern. This is followed by cophonologies triggered by non-dominant /má-/ and replacive-dominant /-<sup>Ⓢ</sup>iyáá/.

Consider this last suffix /-<sup>Ⓢ</sup>iyáá/. Because this suffix triggers dominant GT, the corresponding VI has a dominant constraint ranking in *R*, shown below. Note that I do not provide the actual constraints, but rather its schematic form.

- (15) VI for /-<sup>Ⓢ</sup>iyáá / in Hausa
- $$\left\{ \begin{array}{l} \text{Suffix2} \\ M: [+REFERENTIAL] \\ F: / -^{\text{Ⓢ}}\text{iyáá} / \\ P: - \\ R: \text{MxBM}(T)_{[\text{Induced Basemap}]} \gg \text{IO}(T) \gg \text{MxBM}(T)_{[\{M: \alpha\text{STEM}\}]} \end{array} \right\}$$

This constraint ranking in *R* is the cophonology which the sequence /mákàràncíí -<sup>Ⓢ</sup>iyáá/ is subject to (with the stem /mákàràncíí/ itself being complex). The resulting Matrix-Basemap Correspondence is shown in Table 4 below.

	INPUT		OUTPUT	
MATRIX	H <sup>Ⓛ</sup> H	<sup>Ⓢ</sup> L H		<sup>Ⓢ</sup> L H
MX	/ mákàràncíí	+ iyáá	→ \	\ mákàràncííiyáá \
BASEMAP		<sup>Ⓢ</sup> L H		<sup>Ⓢ</sup> L H
BM	τ τ τ τ τ	+ iyáá	// → //	τ τ τ τ τ iyáá

Table 4: Schematic structure of dominant GT via MxBM-C

As described in chapter 5, the matrix input consists of /mákàràncíí + <sup>Ⓣ</sup>iyáá/ and the highly ranked MxBM-C constraint results in an abstract induced basemap whereby the stem is replaced by equivalent TBUs τ (blue arrow). This results in a basemap input //ττττ + <sup>Ⓣ</sup>iyáá// with unvalued abstract TBUs τ. In the basemap, the floating <sup>Ⓣ</sup> tone transparently maps to the toneless TBUs, which results in an output \\\tau\tau\tau\tau-iyáá\\. Identity between the two outputs results in this tone pattern being imported into the matrix output (red arrow), resulting in the attested output \mákàràncííiyáá\\.

A cophonological model parallel to this was actually brought up by McPherson (2014) and McPherson & Heath (2016), but only to argue against it. Their schematic morpho-phonological tree is below (modified from the original to fit the following example).

- (16) [ TARGET ] [ TRIGGER ]  
 H                    (L)                    H  
 ^                    /                    |  
 [Sána bàbè kómmò] [nó]  
 Sana uncle skinny this  
 POSS N                    ADJ                    DEM  
 ‘this skinny uncle of Sana’s’ (cf. bàbè, kómmó)

[Tommo So – McPherson & Heath 2016]

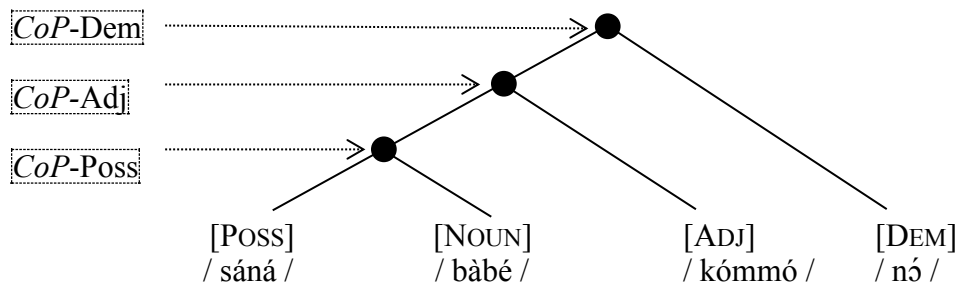

Figure 6 : Cophonology model argued against by McPherson (2014)

In this example, the outermost element is the demonstrative, which would impose a cophonology that results in an all low-tone pattern on its subconstituent. However, notice here that the deeply embedded possessor *Sana’s* underlying high tones are *not* overridden by the demonstrative, even though it is within its scope based on the morpho-phonological tree. This is attributed to it being a previously spelled-out phase to which there is special phase-faithfulness.

Based on these facts, they dismiss a cophonological analysis based on two problems. First, because the possessor has special faithfulness, its identity and constituency must be visible within the highest cophonology. This is incompatible with a central assumption of cyclic models, that of ‘bracket erasure’. However, as discussed in chapter 4 (footnote 20), the issue of ‘bracket erasure’ is conceptually distinct from cyclicity. Informally, whether one has cycles or not is separate from what happens to the contents of cycles afterwards.

A second more serious problem is summed up in McPherson (2014:53-54): a cophonology model would not predict cases where a *lower* head wins. For example, in this case we would not predict cases where the cophonology of the possessor assigns a grammatical tune to the lexical noun and this blocks the application of the cophonology of the higher ADJ/DEM. Such a case is attested within multiple places across the Dogon GT typology, e.g. in Nanga [nzz].

In what follows, I will show that these problems are not insurmountable to a cophonology analysis. I begin by presenting a detailed case study from Izon which exemplifies cophonology-scope and dominant GT at the phrase level.

### 6.3.1 A case study from Izon

In this subsection, I present aspects of the tonology of the Gbarain dialect [gbar1235] of Izon [ijc], based on original fieldwork.<sup>1</sup> In Izon, morphemes fall into a number of tone classes depending on their tonal behavior in multi-word constituents. For a constituent consisting of two morphemes – i.e. [MORPHEME-1 MORPHEME-2] – the Izon data show three primary generalizations: (i) tone patterns are assigned rightward (i.e. from morpheme-1 to morpheme-2), (ii) if morpheme-1 is structurally higher than morpheme-2 (e.g. [ADJECTIVE NOUN]) then dominant tone is assigned, and (iii) if morpheme-1 is structurally lower than morpheme-2 (e.g. [NOUN DETERMINER]) then non-dominant tone is assigned. This follows from the model I have proposed where dominant GT is bound by cophonology-scope to cyclic domains defined largely with reference to syntactic c-command.

Izon is a strongly head-final language of Nigeria, spoken in Rivers State in the Niger Delta. It has two underlying tonemes, /H/ and /L/. Morphemes have either underlying tone based on combinations of these tonemes (valued), or have no underlying tone (unvalued). All lexical morphemes and the majority of grammatical morphemes have underlying tone (a minority are unvalued). In all Izon dialects (and many Ijoid languages), words are divided into a number of ‘tone classes’ based on the systematic effect that they have on neighboring morphemes. In Gbarain Izon, there are three tone classes A, B, and C (a common convention across the Ijoid literature - see Williamson 1988). A three-way tone class minimal pair is below:

Tone Class	Isolation	English	Tone Spread	Shorthand
A	[bìrǐ]	‘wash, bathe’	LH	the LH class
B	[bírí]	‘middle, center’	H	the H class
C	[bìrǐ]	‘dress up’	L	the default L class

Table 5: Three-way tone class minimal pair

Class A assigns a LH pattern on following words, a shorthand for which will be ‘the LH class’. In many cases the H only appears on the final TBU with L’s on preceding TBUs including those of the trigger. In isolation, tone class A morphemes are pronounced with a rising tone in isolation, e.g. [bìrǐ] ‘wash, bathe’.

Tone class B assigns H tone on following words, whose shorthand is ‘the H class’. In most cases, the trigger bears a (L)H pattern but not always. Tone class C bears a wide variety of inherent tonal patterns, but all of them assign an all L pattern to following words. The shorthand for this class is ‘the default L class’.

Tone classes can be fully distinguished in multi-morphemic context. The class A noun *buru* ‘yam’ is pronounced [bùrǔ] in isolation. As shown in Table 6, class A assigns a H tone to the final TBU of the following word if it is underlying toneless (unvalued), resulting in [bùrù kpò] ‘also yam’ and [bùrù kùmò] ‘only yam’. Note that the tone class is provided in subscripts.

Tone class	Noun example	<i>kpò</i> ‘also’	<i>kùmò</i> ‘only’
A the LH class	[bùrǔ]	bùrù <sub>A</sub> <b>kpò</b>	bùrù <sub>A</sub> <b>kùmò</b>
B the H class	[námá]	námá <sub>B</sub> <b>kpò</b>	námá <sub>B</sub> <b>kùmò</b>
C the default L class	[òpóriópò]	òpóriópò <sub>C</sub> <b>kpò</b>	òpóriópò <sub>C</sub> <b>kùmò</b>

Table 6: Tone classes in context

<sup>1</sup> Izon is also called Ijo, Ijò, Ìjò, Ijaw, Izo, Izò, Ìzò, and Ìzò. Relevant tone literature includes Williamson (1965, 1988) and Efere (2001). In this section, all data come from Gbarain Izon, but I will generally just refer to it as Izon.

Compare class A to the other classes. Class B [námá] ‘meat’ assigns H tone to all TBUs of the following toneless word, while class C [òpòríópò] ‘pig’ assigns L tone to all following TBUs. Because each of the words are unvalued, this does not involve dominance; dominant patterns can only be discerned if the target has underlying tone. We will return to this below.

Izon has pre-nominal and post-nominal modifiers. Pre-nominal modifiers fall into one of the three tone classes above. When a pre-nominal modifier appears with a nominal, the noun of the tone deletes and the pattern associated with the tone classifier wins, shown below. In this way, all pre-nominal modifiers are dominant and systematically override tones of the nouns.

Modifier \ Noun		Tone patterns of nouns in isolation					
		A class [bùrù] ‘yam’		B class [námá] ‘meat’		C class [wàrí] ‘house’	
Tone class	A	èbì <sub>A</sub> ‘good’	èbì <sub>A</sub> <b>bùrú</b> [L <b>LH</b> ]	èbì <sub>A</sub> <b>námá</b> [L <b>LH</b> ]	èbì <sub>A</sub> <b>wàrí</b> [L <b>LH</b> ]		
	B	èndì <sub>B</sub> ‘that’	èndì <sub>B</sub> <b>bùrú</b> [L <b>HH</b> ]	èndì <sub>B</sub> <b>námá</b> [L <b>HH</b> ]	èndì <sub>B</sub> <b>wàrí</b> [L <b>HH</b> ]		
	C	kálá <sub>C</sub> ‘small’	kálá <sub>C</sub> <b>bùrú</b> [H <b>LL</b> ]	kálá <sub>C</sub> <b>námá</b> [H <b>LL</b> ]	kálá <sub>C</sub> <b>wàrí</b> [H <b>LL</b> ]		

Table 7: Dominant GT with pre-nominal modifiers

Class A adjective *ebi* [èbì] ‘good’ assigns a LH pattern to all nouns regardless of their underlying tones and underlying tone class (compare all three forms with *ebi*). In contrast, the class B demonstrative *endi* [èndì] ‘that’ and class C adjective *kala* [kálá] ‘small’ assign an all H and all L pattern to the noun, respectively, again regardless of the noun’s underlying tonal structure which is never realized in this context.

To model this dominant behavior, we need to understand the syntactic structure which is the input to spell-out. There are two potential structural positions for these modifiers: as a specifier in a higher XP or as a higher head X° along the same spine. Demonstratives are typically analyzed as heads of a demonstrative phrase DemP (e.g. Adger 2003:253, McPherson 2014), while adjectives are typically an AdjP in the specifier position of a higher functional head (Cinque 2010:25, McPherson 2014). This is reflected in the trees below. Note that in the adjectival tree in Figure 8, FP stands for an unspecified functional (F) projection.

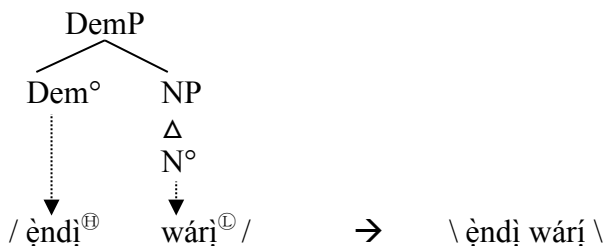

Figure 7: Structure of modification with demonstratives

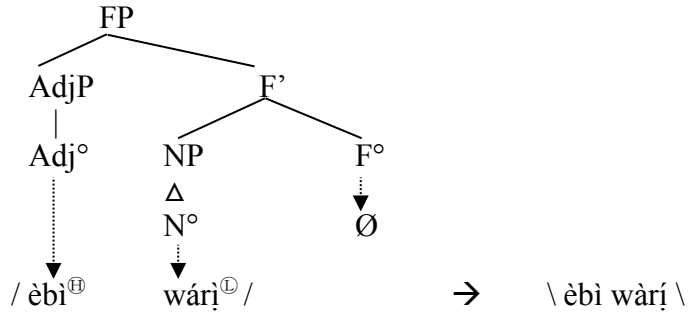

Figure 8: Structure of modification with adjectives

There are several other structural possibilities: the DemP itself is in a specifier position of an FP, the AdjP is in an adjunct position of the NP (which structurally would be equivalent to the specifier), or that the AdjP phrase itself is part of the nouns extended projection (along the same spine) just as the DemP. Positioning DemP as a specifier of a modificational FP is in fact argued for explicitly for Izon by Carstens (2002:7) and adopted for Izon’s sister language Kalabari by Harry (2004:18) (see also Carstens 1991; Giusti 1995; Bernstein 1997; a.o.). Which of these analyses is best depends crucially on syntactic arguments from syntactic evidence, and as such is outside of the scope of this study.<sup>2</sup>

A strength of the present proposal is that all of these syntactic structures map to the same morpho-phonological tree. As discussed in section 6.1.3 above (and in chapter 4), the spell-out operation hierarchy exchange maps both specifiers and higher heads to a position higher in the morpho-phonological tree than lower heads. Therefore, any cophonology imposed by the modifier will scope over a lower head, whether the modifier is in a specifier position or head position. This is shown below (recall that  $\phi$  stands for ‘has cophonology scope over’).

(17)

- a. *CoP-Head*:  $\left\{ \begin{array}{c} \text{Head} \\ \dots \end{array} \right\} \phi \left\{ \begin{array}{c} \text{Complement} \\ \dots \end{array} \right\}$
- b. *CoP-Spec*:  $\left\{ \begin{array}{c} \text{Specifier} \\ \dots \end{array} \right\} \phi \left\{ \begin{array}{c} \text{Head} \\ \dots \end{array} \right\}$

Thus, if mapping in hierarchy exchange proceeds as I have claimed, then the scope falls out of either analysis: modifier as a specifier or modifier as a (higher) head.

There are several other types of modifiers beyond these two, and all of them fall into one of the three tone classes and show dominance effects. These include additional demonstratives, quantifiers, possessors, numerals, adjectives, nouns in [N N] possessive or compound structures, and bare verbs in [V N] clauses (e.g. some compounds, some relative clauses, among others). It is not predictable which tone class a modifier will fall in based on its semantico-syntactic class (cf. the fellow Ijoid language *Kalabari*, where it is – Harry & Hyman 2014). This property therefore must be lexically encoded.

<sup>2</sup> Recall that in Figure 8 we have an abstract FP (functional projection), whose head  $F^\circ$  selects the NP. This analysis leaves open the door that the head  $F^\circ$  maps to a VI with a phonologically null exponent but imposes a dominant ranking resulting in tone deletion of the target. In such a case, the *trigger* of tone deletion would be VI corresponding to  $F^\circ$  but the *sponsor* of tone assignment would be the demonstrative or adjective. In general it is difficult to find empirical arguments for one analysis over the other. I leave this for future work.

	A	B	C
Demonstratives	-	èndì <sub>B</sub> ‘that’	béí <sub>C</sub> ‘this’ bìsá <sub>C</sub> ‘yonder’
Quantifiers	-	kpéí <sub>B</sub> ‘some’ ìndà <sub>B</sub> ‘how many’	dèngí <sub>C</sub> ‘which’
Possessors	inè <sub>A</sub> ‘my’ wò <sub>A</sub> ‘his’ òrì <sub>A</sub> ‘their’	iné <sub>B</sub> ‘your <sub>sg</sub> ’ àrì <sub>B</sub> ‘her’ wó <sub>B</sub> ‘our’ òrì <sub>B</sub> ‘your <sub>pl</sub> ’ tùbà kẹ̀ <sub>B</sub> ‘whose’	-
Numerals	kèni <sub>A</sub> ‘one’ màà <sub>A?</sub> ‘two’ <sup>3</sup>	tárá <sub>B</sub> ‘three’ <i>etc.</i>	-
Adjectives	èbì <sub>A</sub> ‘good’ òpù <sub>A</sub> ‘big’ dìbà <sub>A</sub> ‘big’	zín <sub>B</sub> ‘another’	kálá <sub>C</sub> ‘small’
Noun-noun constructions	A nouns	B nouns	C nouns
Verb-noun constructions	A verbs	B verbs	C verbs

Table 8: Pre-nominal modifiers and their tone class

There are no modifiers which do not assign a tone pattern. In other words, whenever a noun appears with a pre-nominal modifier, its underlying tones do not appear.

The last two structures from Table 8 – noun-noun and verb-noun constructions – involve only a modifying verbal or nominal root (the bare form) followed by the head noun. No other segmental or tonal structure is present expressing these relations. An example is below in (18).

- (18) Noun-noun compound
- òdó<sub>C</sub> ‘mortar’
  - bàrà<sub>C</sub> ‘hand’
  - òdó<sub>C</sub> bàrà ‘pestle’ (= mortar-hand)

In terms of the present analysis, all modifiers are expounded with VIs with a ranking in *R* enforcing dominant GT. For the purposes here, I will call this VI  $\{\underline{\alpha}\text{Mod}\}$ , with the understanding that each of the modifiers above will be endowed with an equivalent internal VI structure. Crucially, the *R* ranking includes a highly ranked constraint of the type  $O_{MX}O_{BM}(\text{TONE})_{[\{M: \underline{\alpha}\text{Mod}\} \{F: \alpha\tau\}]}$  as discussed at length in chapter 5.

- (19) VI structure of all pre-modifiers in Izon
- $$\left. \begin{array}{l} \underline{\alpha}\text{Mod} \\ \dots \\ R: O_{MX}O_{BM}(\text{TONE})_{[\{M: \underline{\alpha}\text{Mod}\} \{F: \alpha\tau\}]} \gg \text{IO}(\text{TONE}) \gg O_{MX}O_{BM}(\text{TONE})_{[\{M: \underline{\alpha}\text{STEM}\}]} \end{array} \right\}$$

As predicted, when there are multiple modifiers, the morpho-syntactically highest (morpho-phonologically most outward) modifier will assign its pattern over the inner modifier and noun.

<sup>3</sup> This form was variable in my notes, sometimes class A, other times class B.

Consider the following cases where the outermost modifier assigns either tone pattern A ('the LH class') (20) or tone pattern C ('the default L class') (21).

(20) Outermost modifier wins – A pattern

/ inè<sub>A</sub> tárá<sub>B</sub> d̩bá<sub>A</sub> bùrǔ<sub>A</sub> /  
 my three big yam  
 POSS [NUM ADJ N ]<sub>TARGET</sub>  
 \ inè<sub>A</sub> **tàrà** **d̩bá** **búrú** \  
 'my three big yams'

[Izon – author fieldnotes]

(21) Outermost modifier wins – C pattern

/ béí<sub>C</sub> màà<sub>A</sub> bùrǔ<sub>A</sub> /  
 this two yam  
 DEM [NUM N ]<sub>TARGET</sub>  
 \ béí<sub>C</sub> **màà** **bùrù** \  
 'these two yams'

[Izon – author fieldnotes]

In (20), the underlying tones of all inner morphemes delete and the LH pattern from class A *ine* 'my' spreads over the entire sequence. Note that the H tone does not dock to the final TBU, but rather to the initial TBU of the second word, a fact we won't discuss here. Similarly in (21), the L pattern from class C *bei* 'this' spreads over the entire sequence.

Tree diagrams for example (20) are below.

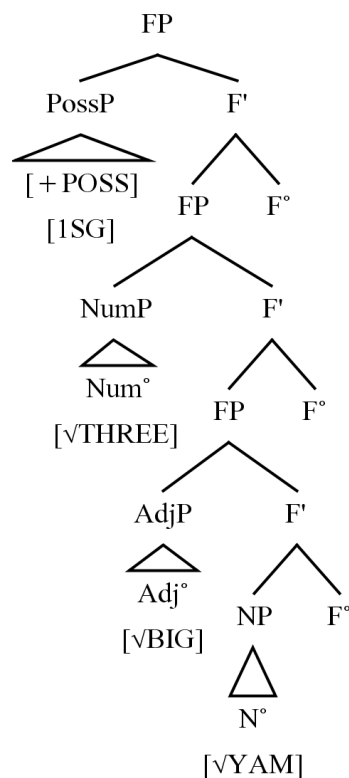

Figure 9: Syntactic structure of (20)

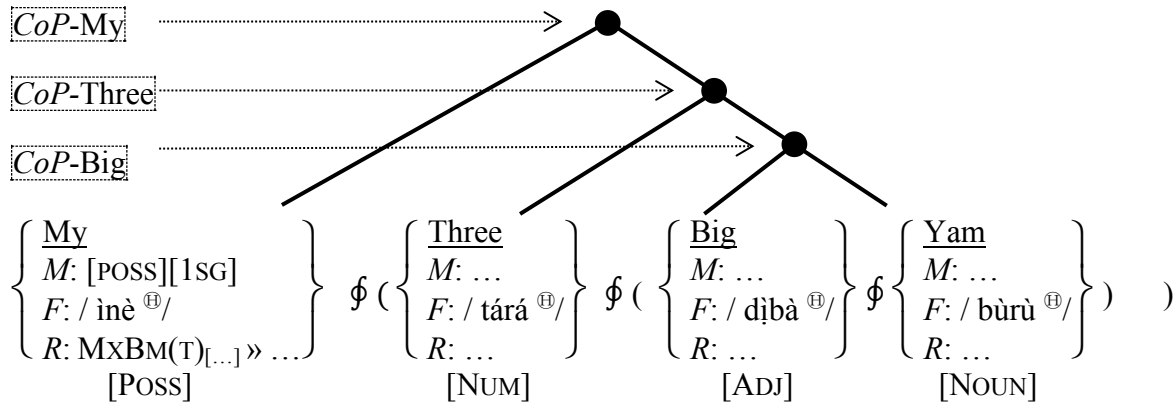

Figure 10: *CoP*-scope of (20)

Figure 9 shows the syntactic structure of this example, assuming that all of the modifiers occupy specifier positions of functional projections (FPs) along the same extended projection as the noun *buru* ‘yam’. Figure 10 shows how these syntactic positions are spelled-out. Each of these modifiers and the noun correspond to a VI which best matches the morphosyntactic features and provides phonological exponence. As each of these modifiers is in a specifier position higher than the next, each has cophonology-scope over all inwardly located morphemes, indicated by the layered  $\phi$  structure. The cophonologies apply cyclically up the tree. The highest modifier – the possessive pronoun *ine* ‘my’ – has a ranking in *R* which enforces dominant GT, causing all underlying tone in the target domain to delete/go unrealized (the three inwardly located morphemes *tara d̩ba buru* ‘three big yams’).

Unlike the Hausa case seen above in (14), these Izon GT patterns involve multi-word inputs and outputs. We therefore require an analysis using Matrix-Basemap Correspondence to be flexible enough to handle these phrase-level cases too. We saw above (and in chapter 5) that dominance is achieved by endowing the  $O_{MX}O_{BM}(Tone)$  constraint the ability to induce an abstract basemap when it contains a deficient projection containing  $\{F: \alpha\tau\}$ . This results in an abstract basemap input such as  $//\tau\dots\tau//$  with the same number of TBUs as the matrix input but without any tonal or segmental structure. In order to preserve the multi-word structure of the matrix input within the basemap input, the deficient projection also contains  $\{F: \alpha\phi\}$  which picks out inputs that have the same prosodic structure, the same number of phonological words ( $\omega$ ). The VI for *ine* ‘my’ therefore conditions a highly-ranked constraint  $O_{MX}O_{BM}(T)_{[\{M: [+POSS][1SG]\} \{F: \alpha\tau; \alpha\phi\}]}$  involving both  $\alpha\tau$  (same number of TBUs) and  $\alpha\phi$  (same number of prosodic constituents). This is shown below:

(22) VI for modifier *ine* ‘my’ in Izon

$$\left\{ \begin{array}{l} \underline{\text{My}} \\ M: [+POSS][1SG] \\ F: / \text{inè}^{\oplus} / \\ R: O_{MX}O_{BM}(T)_{[\{M: [+POSS][1SG]\} \{F: \alpha\tau; \alpha\phi\}]} \gg IO(T) \gg O_{MX}O_{BM}(T)_{[\{M: \alpha\text{STEM}\}]} \end{array} \right\}$$

This results in the following MxBM-C structure, in the table below.



	INPUT		OUTPUT	
MATRIX	L <sup>⊕</sup>	H <sup>⊕</sup>	L	H <sup>⊕</sup>
MX	∧	∧	∧	∧
	ìnè	tárá díbá búrú	ìnè (tárá)(díbá)(búrú)	
BASEMAP	L <sup>⊕</sup>		L	H <sup>⊕</sup>
BM	∧		∧	∧
	ìnè	(τ τ) (τ τ) (τ τ)	ìnè (τ τ) (τ τ) (τ τ)	

Table 9: Multi-word dominant GT via MXBM-C

In this mapping, the induced basemap (blue arrow) contains a target consisting of (τ τ) (τ τ) (τ τ), an abstraction preserving the number of TBUs and phonological words (the parentheses). The tonal structure of the trigger /ìnè<sup>⊕</sup>/ then spreads over the unvalued abstract target, resulting in a matrix output \ìnè (τ τ) (τ τ) (τ τ)\. The exact tonal association principles are outside of our scope here, but importantly this clearly shows a dominant pattern. This constraint then enforces identity between the two outputs (the red arrow), resulting in the basemap tone pattern copying to the matrix output. In this way, dominant GT *above* the ‘word’ proceeds in the same way as it does *below* the ‘word’. From the DM/non-Lexicalist perspective, it is predicted that there should be no qualitative differences between word vs. non-word phenomena.

In the case above, all of the modifiers are modifying the lexical head *buru* ‘yam’. There are also complex noun phrases in Izon where one modifier is actually modifying another modifier rather than the lexical head. Compare the following compound.

(23)

- a. / òsɪ<sub>A</sub> námá<sub>B</sub> wáɾí<sub>C</sub> / → \ òsɪ<sub>A</sub> **nàmà wáɾí** \  
 snail meat house ‘a snail-meat house’ (a house~place where there is snail-meat)
- b. [ snail [ meat house ]<sub>TARGET</sub> ] ← Grammatical tone
- c. [ [ snail meat ] house ] ← Semantics

This complex compound consists of three nouns with no (overt) morphological marking. The first noun – tone class A *osi* ‘snail’ – assigns its LH pattern on the following two nouns whose tones are deleted in this context (compare the input to the output in (23)a.). We can therefore say that the target (target-host) of the grammatical tune is the final two nouns, shown in b. However, the semantics indicate the opposite bracketing: *osi* ‘snail’ is modifying *nama* ‘meat’ and not *wari* ‘house’. The intended meaning is a house (~place, stall) where there is snail-meat, not a snail’s meat-house. This is a classic example of a bracketing paradox where constituency conflicts across modules.

The syntactic structure is provided below in Figure 11, followed by the post-spell-out structure resulting from hierarchy exchange (revealing the bracketing paradox). The embedded modifier snail is highlighted in yellow.

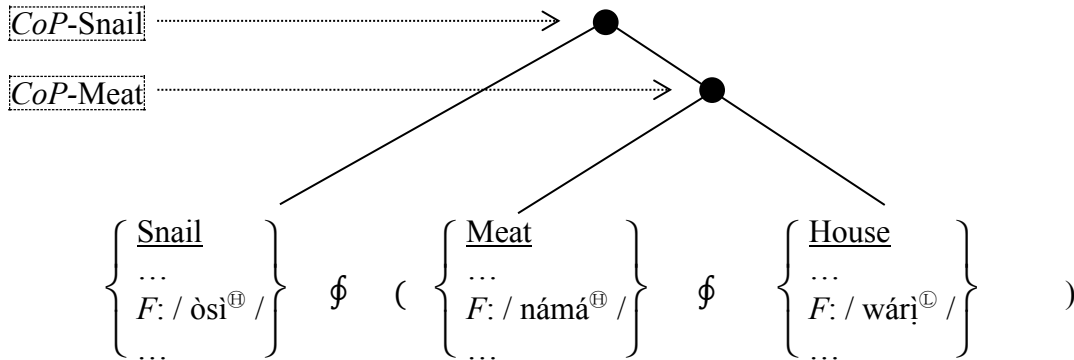
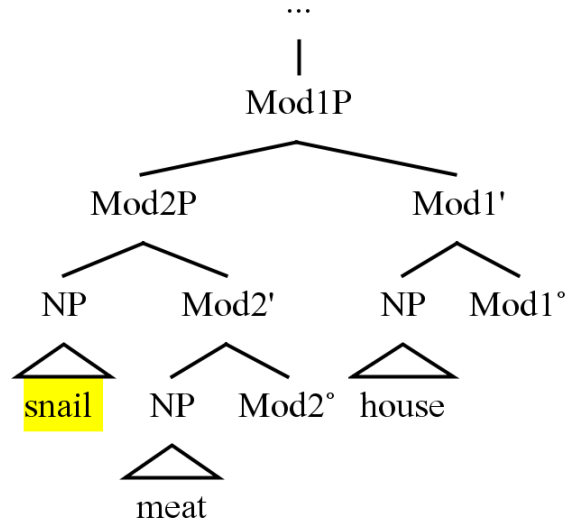

Figure 11: Embedded modifier with *CoP*-scope over the ‘head’ noun

This falls in line with our predictions that embedded specifiers (here ‘snail’) will scope both over their containing phrase’s head (‘meat’) and the matrix head (‘house’). Note that here, the head of the embedded specifier’s head itself (‘snail’) does not c-command the matrix head (‘house’). This supports the idea that c-command is mediated by a spell-out operation rather than referenced directly. In short, the specifier of a specifier has *CoP*-scope over the entire sequence, schematized below.

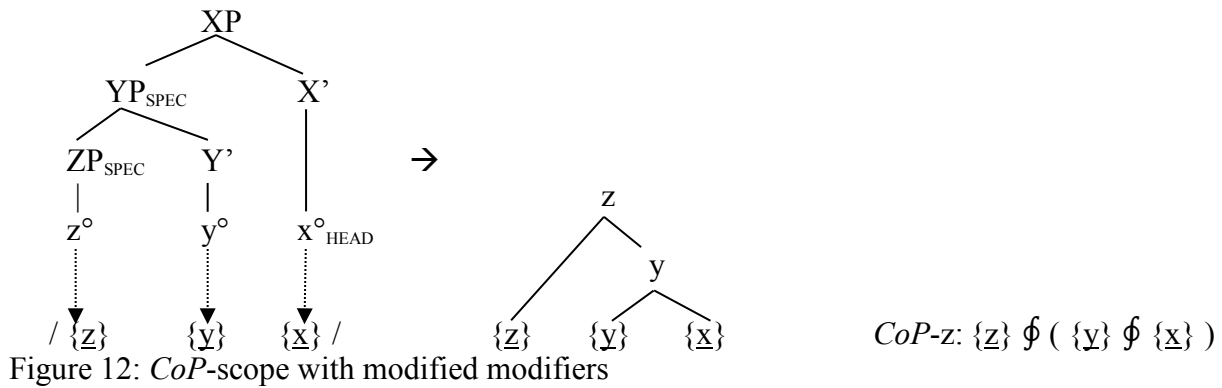

Figure 12: *CoP*-scope with modified modifiers

The head of the entire construction is  $x^\circ$ . This XP is modified by YP in specifier position. VIs mapped from  $y^\circ$  therefore take *CoP*-scope over VIs mapped from  $x^\circ$ . We see that YP itself is modified by ZP in its specifier position. VIs mapped from  $z^\circ$  take *CoP*-scope over both VIs from  $y^\circ$  and  $x^\circ$ , i.e. *CoP*-z:  $\{z\} \phi (\{y\} \phi \{x\})$ .

Further support comes from parallel facts in Kalabari, a language related to Izon (Harry & Hyman 2014:661). A complex compound  $[N_1 [N_2 N_3]]$  (24) is tonally identical to a compound  $[[N_1 N_2] N_3]$  (25) with respect to the scope of the grammatical tune.

(24)  $[N_1 [N_2 N_3]]$

a. /tùbò àbàjì námá /  
child ocean animal

⊕ ⊕

\tùbò [àbàjì námà]<sub>TARGET</sub> \~

⊕ ⊕

\tùbò [àbájì námà]<sub>TARGET</sub> \

‘child’s ocean animal (≈ the ocean animal of the child)

b. [child<sup>⊕⊕</sup> [ocean animal]<sub>TARGET</sub>]

← Grammatical tone

c. [child [ocean animal]]

← Semantics

[Kalabari – Harry & Hyman 2014]

(25)  $[[N_1 N_2] N_3]$

a. /é<sup>+</sup>né mìnjì fù<sup>+</sup>rù /  
rain water smell

⊕ ⊕

\é<sup>+</sup>né [mìnjì fùrù]<sub>TARGET</sub> \~

⊕ ⊕

\é<sup>+</sup>né [mínjí fùrù]<sub>TARGET</sub> \

‘rainwater smell’ (≈ the smell of rainwater)

b. [rain<sup>⊕⊕</sup> [water smell]<sub>TARGET</sub>]

← Grammatical tone

c. [[rain water] smell]

← Semantics

[Kalabari – Harry & Hyman 2014]

In both of these examples, a <sup>⊕⊕</sup> tune appears between  $N_1$  and  $N_2$  and is the consistent exponence found in  $[N N]$  constructions (expressing noun compounds and nominal possession equally). Examples (24)-(25) show variation on where the <sup>⊕⊕</sup> tune docks, either at the boundary between  $N_2$  and  $N_3$  or entirely on  $N_2$  (the valuing of other TBUs is predictable based on the position of the <sup>⊕⊕</sup> sequence). The first example in (24) with  $[N_1 [N_2 N_3]]$  exhibits isomorphy between the scope of the grammatical tune and its semantics. In this case,  $N_2$  modifies  $N_3$ , and  $N_1$  modifies this entire complex.

In contrast in (25), the  $[[N_1 N_2] N_3]$  structure exhibits conflicting constituency (a bracketing paradox). The scope of the grammatical tune is the final two nouns, while the semantic bracketing consists of /é<sup>+</sup>né/ ‘rain’ only modifying /mìnjì/ ‘water’, not the third noun /fù<sup>+</sup>rù/ ‘smell’. If grammatical tone directly reflected the semantic scope we would expect *two* applications of the floating <sup>⊕⊕</sup> sequence, namely  $[[\text{rain}^{\oplus\oplus} \text{water}]^{\oplus\oplus} \text{smell}]$  (in virtual Kalabari). Such a structure is not found.<sup>4</sup> See also Harry (2004:72-80) for extensive examples.

<sup>4</sup> Note that  $N_3$  in these cases has L tone, which is the default toneme. An all L pattern is found on several other cases of nouns modified by complex modifiers, e.g. (Harry & Hyman 2014:662-664). Therefore, the L tone on  $N_3$  in the bracketing paradox case may be a default L. The one piece of evidence against this is that we would expect then that

Let us return to the Izon language to explore another issue: post-nominal modifiers. These modifiers include determiners (definiteness, plurality), quantifiers (existential, universal), and other meanings ('also', 'only', 'some (of)', 'a particular, instead'). For all of the *pre*-nominal modifiers, we saw that they group into tone classes A, B, and C. In contrast, post-nominal modifiers have their own tonal properties. In the table below, post-nominal modifiers are grouped into types 1-4 according to their tonal behavior. The representation at the top is their hypothesized underlying tonal value (where  $L_w$  = weak low tone and  $L_s$  = strong low tone, placeholders for a more thorough analysis).<sup>5</sup>

	1 - / Ø /	2 - / $L_w$ /	3 - / $L_s$ /	4 - / H L /
kpɔ	'also'	bì DEF	bèi 'some particular'	mò sè 'all the'
kì	'particular, instead'	mò DEF.PL	sè 'all'	
ɔmɔ	INDEF.PL			
kumɔ	'only'			

Table 10: Post-nominal modifiers split by tonal behavior

Class 1 /Ø/ post-nominal modifiers are analyzed as underlyingly toneless (unvalued). When these follow modified nouns, they show the following patterns in (26):

(26) Nouns with post-nominal modifier 1 / Ø /

			<i>kumɔ</i> 'only'	
a.	A	'the LH'	\ bùrù <sub>A</sub>	<b>kùmò</b> \ 'only a yam'
b.	B	'the H'	\ námá <sub>B</sub>	<b>kùmò</b> \ 'only meat'
c.	C	'the default L'	\ òpóriópò <sub>C</sub>	<b>kùmò</b> \ 'only a pig'
			<i>kpɔ</i> 'also'	
d.	A	'the LH'	\ bùrù <sub>A</sub>	<b>kpò</b> \ 'also a yam'
e.	B	'the H'	\ námá <sub>B</sub>	<b>kpò</b> \ 'also meat'
f.	C	'the default L'	\ òpóriópò <sub>C</sub>	<b>kpò</b> \ 'also a pig'

In (26)a.-c. with toneless post-nominal modifier *kumɔ* 'only', the tone pattern associated with the tone class of the noun spreads onto *kumɔ* resulting in different surface patterns: [LH] (a.), [HH] (b.), and [LL] pattern (c.). With monosyllabic *kpɔ* 'also' this results in patterns [H] (a.-b.) or [L] (c.). With this class of post-nominal modifier, the tone pattern on the modifier always changes in context and has no stable tone.

In contrast are post-nominal modifier classes 2, 3, and 4:

(27) Nouns with post-nominal modifier 2 /  $L_w$  /

			<i>bì</i> DEF 'the'	
a.	A	'the LH'	\ bùrù <sub>A</sub>	<b>bì</b> \ 'the yam'
b.	B	'the H'	\ námá <sub>B</sub>	<b>bì</b> \ 'the meat'
c.	C	'the default L'	\ òpóriópò <sub>C</sub>	<b>bì</b> \ 'the pig'

the [N<sub>1</sub> N<sub>2</sub>] sequence of the [[N<sub>1</sub> N<sub>2</sub>] N<sub>3</sub>] complex would look identical to [N<sub>1</sub> N<sub>2</sub>] in isolation, which is not the case. For example, /é\*bé/ 'insect' + /námá/ 'meat' is [é\*bé námà] 'the insect's meat' (cf. \*[é\*bé námá]) (Harry & Hyman 2014:652). Compare this to the (optional) form above in (25) [é\* né mǐnjǐ fùrù] where N<sub>2</sub> has [HH].

<sup>5</sup> I do not show a fifth class, consisting solely of a floating tone /<sup>FB</sup>/ which docks to the right edge of a noun and expresses specificity, due to a lack of data.

(28) Nouns with post-nominal modifier 3 / L<sub>s</sub> /

				<i>bei</i> ‘some of’	
a.	A	‘the LH’	\ bùrù <sub>A</sub>	<b>bèi</b> \	‘some particular yam’
b.	B	‘the H’	\ námá <sub>B</sub>	<b>bèi</b> \	‘some particular meat’
c.	C	‘the default L’	\ òpóriópò <sub>C</sub>	<b>bèi</b> \	‘some particular pig’

## (29) Nouns with post-nominal modifier 4 / H L /

				<i>mọ sẹ</i> ‘all the’	
a.	A	‘the LH’	\ bùrù <sub>A</sub>	<b>mọ sẹ</b> \	‘all the yams’
b.	B	‘the H’	\ námá <sub>B</sub>	<b>mọ sẹ</b> \	‘all the meat’
c.	C	‘the default L’	\ òpóriópò <sub>C</sub>	<b>mọ sẹ</b> \	‘all the pigs’

In (27) is *bì* DEFINITE ‘the’, called /L<sub>w</sub>/ in Table 10 which stands for ‘weak low’. This post-nominal modifier surfaces as falling [bî] with tone classes A and B due to the spreading H (a.-b.) but as low [bì] with class C with no H (c.). Regardless of tonal context, *bì* consistently has a L tone. In contrast, Type 3 is even more consistent in that it always surfaces with low tone, e.g. [bèi] ‘some particular’ in all examples in (28).

Note this contrast between class A nouns with *bì* in (27)a. versus *bei* in (28)a. The former shows the H tone associated with class A docking to the modifier – i.e. [bùrù bî] – while the latter shows it self-docking to the noun sponsor itself – i.e. [bùrù bèi]. Because of this minimal difference, I classify *bei* as /L<sub>s</sub>/ which stands for ‘strong low’. Weak low versus strong low is not a general aspect of Izon tonology, but is an idiosyncrasy to post-nominal modifiers. A better analysis may be found at some future point, and I use these as placeholder labels only.

Finally, consider 4 *mọ sẹ* ‘all the’ which is consistently [H L] in all contexts in (29). If a tone class C noun ends in a H tone, *mọ* can be realized with a rising tone, e.g. *ingo* [ingǒ] ‘fish trap’ in isolation and [ingǒ mọ sẹ] ‘all the fish traps’ in context. I take this to be the floating <sup>①</sup> docking to the modifier. The same rising happens if a noun with underlying /HL/ surfaces as [H] due to final high vowel elision, e.g. *wari* [wári] ‘house’ in isolation and [wár mọ sẹ] ‘all the houses’ in context.

Taken together, these data reveal a number of key patterns in support of my model. First, nouns can spread their associated tonal pattern onto both unvalued (e.g. toneless class 1) and valued post-nominal modifiers (classes 2-4), but critically *this spreading pattern cannot override the underlying tones of such modifiers*. Thus nouns show non-dominant patterns in this context. This falls out naturally from our proposal regarding hierarchy exchange and cophology-scope.

To explain, let us adopt that post-nominal modifiers are syntactically high in the structure (high D° and Q° heads, or some other type of functional head). Comparable meanings in other languages occupy these positions, and D°/Q° heads which branch to the left is expected typologically in a strongly head-final language such as Izon. This results in the following structure in Figure 13 (recall that the red-arrow indicates Spell-Out of the syntactic image on the left to the abridged morphological image on the right):

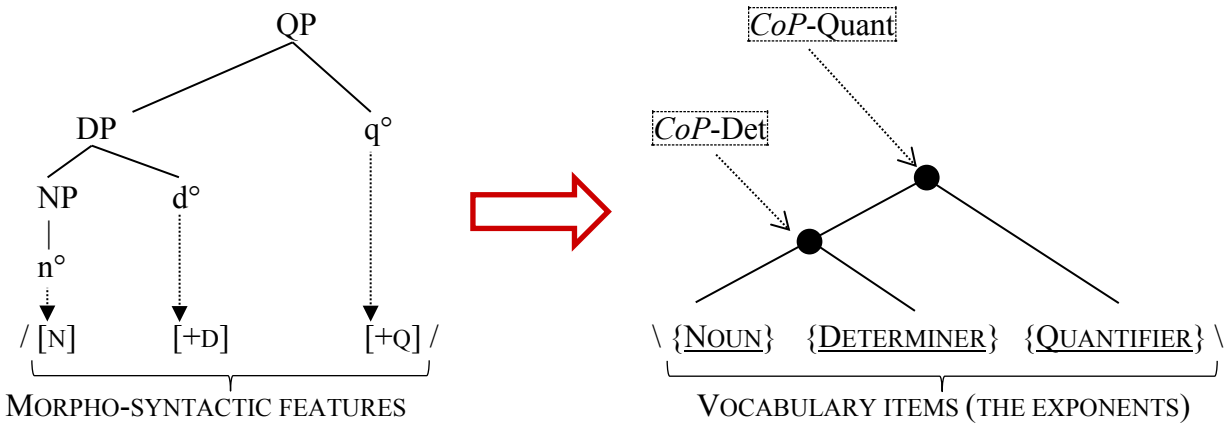

Figure 13: Spell-out with Izon post-nominal modifiers

Here, the determiner/quantifier is syntactically higher than the noun, and is mapped to a position which is morpho-phonologically outward (as expected). Therefore, when cyclic application of cophonologies takes place, the determiner and quantifier are not within the cophonology-scope of the noun, and consequently the noun cannot impose any dominant GT. Importantly, this does not entail that the noun cannot assign *any* tone. If the noun has floating tones, these tones can dock to the modifiers. Crucially, however, they cannot override them. The determiner and quantifier themselves do not impose dominant GT onto the noun, unlike pre-nominal modifiers.

In this way, multi-word phrases in Izon fully meet the conditions of dominant GT. If the trigger of the GT is morpho-syntactically ‘higher’ (morpho-phonologically ‘outward’), then it can assign a dominant pattern to the target. If it is morpho-syntactically ‘lower’ (morpho-phonologically ‘inward’), then it can *only* assign a non-dominant pattern (i.e. impose no special cophonology onto it). This is equally seen when pre-nominal and post-nominal modifiers co-occur. Consider the following two examples.

(30) Unvalued (toneless) post-nominal modifier

/ ìnè<sub>A</sub> ègbèrǐ ɔmɔ /  
 my story INDEF.PL  
 POSS NOUN DET  
 [ⓁⓂ] ]<sub>TARG</sub>  
 \ ìnè<sub>A</sub> [ègbé<sup>í</sup> ɔ<sup>m</sup>ɔ] \  
 ‘my stories’

[Izon – author fieldnotes]

(31) Valued (low-toned) post-nominal modifier

/ ìnè<sub>A</sub> sèi tárá dǐbǎ bùrǔ mɔ /  
 my bad three big yam DEF.PL  
 POSS VERB NUM ADJ NOUN DET  
 [Ⓛ Ⓜ] ]<sub>TARG</sub> L  
 \ ìnè<sub>A</sub> [sèi tárá dǐbá bú<sup>ú</sup>] mɔ \  
 ‘≈ the three big spoiled yams of mine’

[Izon – author fieldnotes]

In (30), the tone class A modifier *ine* ‘my’ (‘the LH class’) assigns a LH pattern to all following modifiers. This includes the noun *egberi* ‘story’ (which is valued) and the post-nominal modifier *ɔmɔ* INDEF.PL (which is unvalued). In this case, the entire sequence is subject to the LH tune (note that the H spreads over most TBUs due to an idiosyncrasy of assigning tones to onset-less words – this is an independent phenomenon).

In contrast, in (31) this same modifier *ine* ‘my’ is the outermost *pre*-nominal modifier. This assigns the LH pattern to all inwardly located pre-nominal modifiers as well as the noun, but it does *not* assign any pattern to /mò/ DEF.PL. Unlike all other morphemes, the underlying low tone of the determiner /mò/ (/L<sub>w</sub>/ to be exact, from Table 10) does not delete.<sup>6</sup> Just as with [NOUN DETERMINER] constructions, in [MODIFIER NOUN DETERMINER] constructions the modifier is syntactically lower (morpho-phonologically inward) compared to the determiner and therefore cannot assign any dominant pattern onto it.

We therefore see a qualitative difference between valued and unvalued modifiers. This affirms a general prediction of this theory which accounts for dominance effects by cophology-scope derived from hierarchy exchange. Consider the figure below:

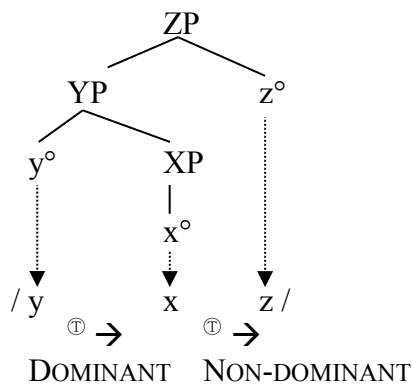

Figure 14

A higher-outer element *y* can be a dominant trigger with a lower-inner element *x* (its target), but not vice versa. However, this does not preclude tonal interaction with higher elements: a lower-inner element *x* can trigger a *non-dominant* GT pattern on a higher-outer element *z*. This would be contradicted if *y* or *x* deleted the tones of *z* under replacive- or subtractive-dominant GT, and is therefore a fully falsifiable model.<sup>7</sup>

The final aspect of Izon I bring up is the special case of [OBJECT VERB] constructions. As stated above, one typological generalization to capture is the dominant GT asymmetry. This asymmetry has three parts: (i) affixes can be dominant GT triggers onto roots, (ii) modifiers can be dominant GT triggers onto lexical heads, and crucially here (iii) objects can be dominant GT triggers onto verbs. The reverse is not possible.

In chapter 4, I laid out assumptions regarding the syntax of [OBJECT VERB] constructions. If we place objects universally in a specifier position (or at least in a specifier position in the relevant languages), it would naturally follow that objects impose dominant GT onto verbs, because specifiers are systematically mapped to morphologically ‘outward’ positions. We can do so if we assume that all verbs consist of a categorizing head  $v^\circ$  (the head of the phrase) and a verbal root phrase  $\sqrt{P}$  (its complement, headed by  $\sqrt{\text{ROOT}}$ ), as shown in the figure below.

<sup>6</sup> Note that in (31) here, the L<sub>w</sub> determiner /mò/ surfaces as low-toned [mò] when adjacent to a complex NP, but surfaces as falling [mò̂] when adjacent to a simplex noun (cf. (27)a-b). I leave this issue aside here. In both cases, the underlying low tone is not deleted.

<sup>7</sup> This also shows that it not the case that the leftmost word within the noun phrase takes *CoP*-scope over all following morphemes. It must both be to the left (precedence) and be morphologically outward (hierarchy).

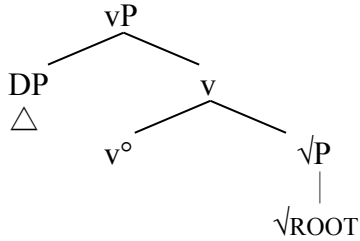

Figure 15: Syntactic structure with object in specifier position

Because the complement position of  $v^\circ$  is occupied, the only position for the object DP is in the specifier position of  $vP$ , where it can c-command out and thus impose a dominant GT pattern as mediated by hierarchy exchange. Placing objects in specifier position is common practice in generative inquiry for different reasons (although almost never by default), e.g. Larson (1988), Collins (1997), Hale & Keyser (1998), Brody's (2000a, 2000b) 'mirror theory' (discussed in Svenonius 2016), among other places.

Object dominance can be seen in Izon (as in other Ijoid languages such as Kalabari). Both nouns and verbs have contrastive tone in Izon and are thus underlyingly valued. In an [OBJECT VERB] construction, however, the underlying tones of the verb are deleted and the melody associated with the tone class of the noun is assigned to the verb. This is seen below with the high-toned verb /fě/ 'buy' which has rising tone (a.), high tone (b.), or low tone (c.) depending on the object.

- (32) Replacive-dominant GT - [OBJ ► V]
- |    |              |                 |                            |   |                |             |
|----|--------------|-----------------|----------------------------|---|----------------|-------------|
| a. | Tone class A | 'the LH'        | / bùrù <sub>A</sub> + fě / | → | bùrù <b>fě</b> | 'buy a yam' |
| b. | Tone class B | 'the H'         | / námá <sub>B</sub> + fě / | → | námá <b>fě</b> | 'buy meat'  |
| c. | Tone class C | 'the default L' | / òró <sub>C</sub> + fě /  | → | òró <b>fě</b>  | 'buy a mat' |
- [Izon - author fieldnotes]

If objects are specifiers, then several facts about their tonal behavior fall out naturally. For example, if the object noun is modified, the modifier has *CoP*-scope over both the noun *and* the verb, assigning its tone pattern over both. This is another case of a bracketing paradox which is resolved if we assume a type of hierarchy exchange in which specifiers embedded within a matrix specifier scope over the matrix specifier and the matrix head. For example, consider the following data involving a set of imperatives of the structure [ [MODIFIER NOUN]<sub>OBJECT</sub> VERB ]:

- (33)
- |    |   |                 |                   |                   |                      |                     |
|----|---|-----------------|-------------------|-------------------|----------------------|---------------------|
|    |   |                 | / ___             | bùrù <sub>A</sub> | gbòrò <sub>A</sub> / | 'plant (a) ___ yam' |
| a. | A | 'the LH'        | òpù <sub>A</sub>  | <b>bùrù</b>       | <b>gbóró</b>         | 'plant a big yam'   |
| b. | B | 'the H'         | èndì <sub>B</sub> | <b>bùrú</b>       | <b>gbòrò</b>         | 'plant that yam'    |
| c. | C | 'the default L' | kálá <sub>C</sub> | <b>bùrù</b>       | <b>gbòrò</b>         | 'plant a small yam' |
- [Izon - author fieldnotes]

Each of these examples has a modifier of a different tone class. Example a. is class A *opu* 'big' ('the LH'), which replaces underlying tones of both the noun and the verb resulting in a surface LH pattern. Class B *èndì* 'that' ('the H') in b. and *kala* 'small' ('the default L') in c. are likewise dominant and assign a HL and an all L pattern respectively.<sup>8</sup>

<sup>8</sup> There is a complication here: in an NP, the LH melody of a tone class A word spreads over the entire domain, as in (i.) below. However, in a VP the LH melody spreads only up to the penultimate word in its domain. Here, the final word bears L tones as in (ii.) below (independent evidence shows that the final word need not be a verb). I will not





Nouns can act as modifiers of other nouns in [N N] possessive constructions. The first noun is the possessor, and the second noun is the possessed. Each noun appear as a [ROOT SUFFIX] construction, and straddling between them is a complex floating tone sequence [POSSESSION] ↔ /<sup>L</sup> <sup>M</sup> <sup>H</sup>/, illustrated below.

		Possessed	āsāṅg-ā ‘head-SG’	gát-ā ‘shape-SG’
			ùkùn-ā ‘ear-SG’	šíim-ā ‘tail-sg’
Possessor				
Class I	a.	àbìn-ā ‘elephant-SG’	àbìn- <u>à</u> <u>ùkùn</u> -ā	‘elephant’s ear’
	b.	āgūd-ā ‘waterpot-SG’	āgūd- <u>à</u> <u>ùkùn</u> -ā	‘handle (= ear) of waterpot’
	c.	kííś-ā ‘girl-SG’	kííś- <u>à</u> <u>āsāṅg</u> -ā	‘girl’s head’
	d.	ít-ā ‘house-SG’	ít- <u>à</u> <u>ūd-ā</u>	‘house’s door’
Class II	e.	kāās-ā ‘belly-SG’	kāās-ā <u>gāt-ā</u>	‘shape of a belly’
	f.	ál-ā ‘lizard-sg’	ál-ā <u>šíim</u> -ā	‘lizard’s tail’

Table 12: Possessive constructions showing strating GT in Kunama

The floating <sup>L</sup> docks to the first noun (the possessor) while the <sup>M</sup> <sup>H</sup> sequence docks to the second noun (the possessed). With class I nouns (rows a.-d.), the <sup>L</sup> replaces the M tone of the suffix /-ā/ SG but does not affect the tone of the nominal root of the possessor. In contrast, compare class II roots which have a floating <sup>H</sup> that docks to the suffix, e.g. /kāās<sup>H</sup>-ā/ → \kāās-ā\̄. When such words appear as the possessor (rows e.-f.), the floating <sup>L</sup> does *not* dock to the [HM] contour [-ā].

In contrast, consider the <sup>M</sup> <sup>H</sup> sequence which docks to N<sub>2</sub> (the possessed). In all cases, the underlying tones of the nominal root are deleted (compare the L, M, and H sequences in the underlying form at the top to the possessed tones in context). If the nominal root is two or more TBUs then the <sup>M</sup> <sup>H</sup> docks to it without complication, as in rows a.-b., c., and f. (I ignore the fact here that [āsāṅg-] [MHM] ends in [M]). If the nominal root is one TBU however (rows d. and e.), the <sup>M</sup> portion docks to the root, but the <sup>H</sup> portion docks onto the mid tone suffix and creates a derived contour tone [HM̄].

These surface patterns support the need for an asymmetric cophonology model. First, the facts support the following interpretation: for the /<sup>L</sup> <sup>M</sup> <sup>H</sup>/ pattern, the portion which falls on the following nominal root is dominant in that it systematically replaces any tone which is present. However, the initial <sup>L</sup> is neutral with respect to the preceding noun which it docks on: it will replace only the final /M/ tone of the suffix, and only if this suffix does not bear a floating <sup>H</sup> from the root. Likewise, if the second noun root is too small, the <sup>H</sup> of the <sup>M</sup> <sup>H</sup> sequence docks to the following suffix but does not override it, a classic neutral pattern. In total, this /<sup>L</sup> <sup>M</sup> <sup>H</sup>/ pattern shows both dominant and neutral aspects.

We can make sense of this if we examine how the syntactic structure (its syntactic image) maps to a morpho-phonological structure (a morphological image), presented below in Figure 16. These are representations of the sequence [kííś-à āsāṅg-ā] ‘girl’s head’ (row c. in Table 12).

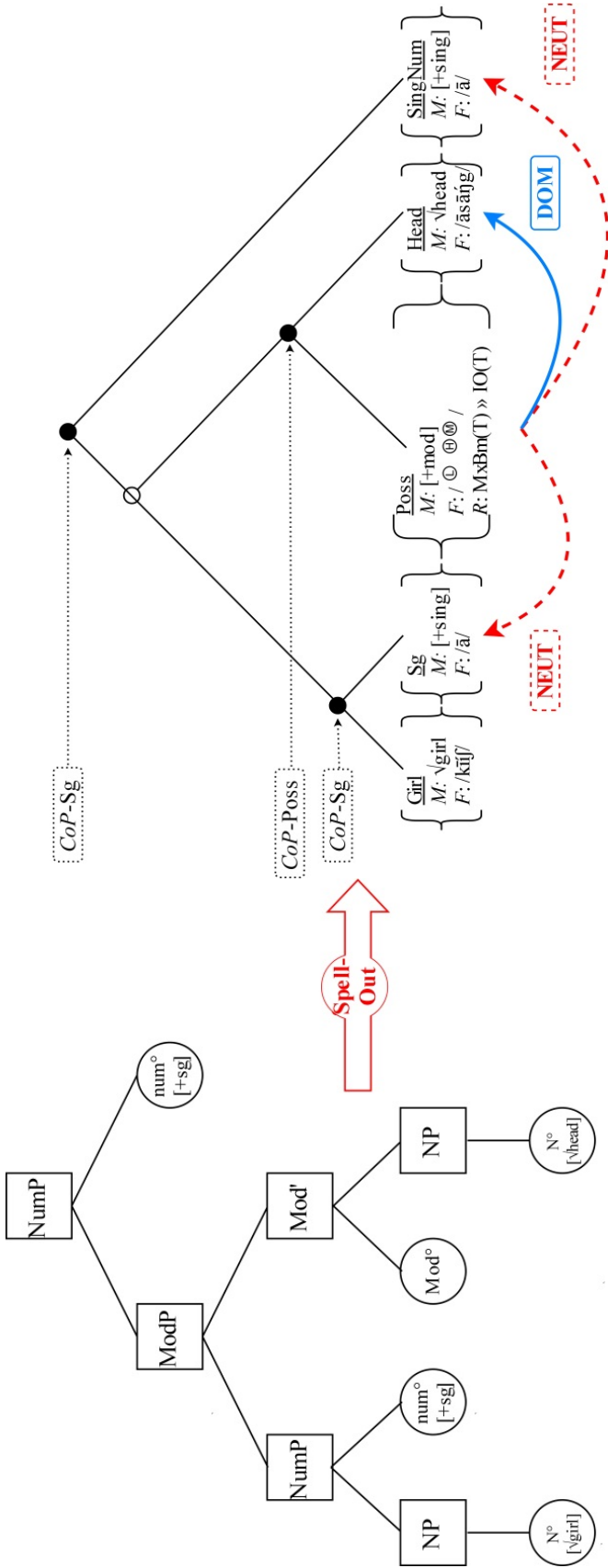

Figure 16

The proposed syntactic structure is on the left of this figure. The main spine consists of an extended projection of the lexical head noun /āsāŋg-/ ‘head’. Above this head is a Mod<sup>o</sup> head which stands for modification and a number head Num<sup>o</sup> which marks this noun as [+SG]. In the specifier position of ModP is the first noun consisting of a root /kīš-/ ‘girl’ and the same Num<sup>o</sup> [+SG]. This syntactic structure is then sent to spell-out where it is subject to hierarchy exchange. This results in the morpho-phonological structure on the right.

Let us break down this structure, and see how it supports my model of dominance. First, the terminal syntactic heads are spelled-out with vocabulary items which match in features, resulting in the 5-exponent linear string /kīf- + -ā + <sup>Ⓛ</sup> <sup>Ⓜ</sup> + āsāŋg- + ā/. The final element is the highest syntactic head and has *CoP*-scope over the entire sequence. However, there is no evidence that it imposes any special phonology or tonology. The lower VIs corresponding to the lower functional heads {Sg} and {Poss} (the 2<sup>nd</sup> and 3<sup>rd</sup> VIs) take *CoP*-scope over their sister nominal root. The first noun is in specifier position and therefore can be mapped to a position where it scopes as a whole over the head, or one in which the specifier and head are in two different local domains. Let us assume that they are separate, as there is no evidence to differentiate at this point. We can represent this as a hollow circle as opposed to the solid black circles showing where cophologies apply. For discussion of having both spell-out possibilities, refer to Table 1, row b. above.

Important for understanding these patterns is the ranking *R* of the VI {Poss}, the VI where the floating tone sequence resides. This ranking results in a dominant GT pattern whereby the tones of the target are deleted. The only morpheme within the scope of this {Poss} VI is the second noun root, and is consequently the only VI whose tones are automatically deleted. This dominant pattern is indicated by the solid blue arrow.

The dominant VI {Poss} does *not* have *CoP*-scope over the [NOUN SUFFIX] unit which appears to its left (it is in its specifier position), nor does it have *CoP*-scope over the singular suffix to its right (the higher head). Therefore, any floating tones sponsored by this VI may fall on these elements but they cannot systematically replace all underlying tone. These are typical neutral patterns, and are indicated as such by the dashed red arrows.

To conclude this subsection, floating tones sponsored by a VI show a dominant pattern only if the VI has *CoP*-scope over its target. If it does not, the floating tones may dock, but they only show a neutral pattern. I now turn to another place where this is seen: floating tones sponsored by lexical items, which we have seen in this Kunama data (Class II and III noun roots in Table 11).

## 6.4 Root-sponsored floating tone

### 6.4.1 Root-sponsored floating tone is not dominant

Thus far, we have discussed floating tones in terms of grammatical tone patterns. The majority of triggers which co-vary with tonal changes are functional morphemes expressing grammatical meaning. However, there are a substantial number of languages where lexical morphemes (e.g. nominal and verbal roots) can also sponsor tonal changes. One clear prediction from the cophology model adopted here is that a lexical root should never assign a dominant GT pattern to functional material it co-occurs with. This is borne out.

I will refer to such cases as **root-sponsored floating tone** (a somewhat cumbersome name but one which is maximally transparent).<sup>9</sup> We saw several cases of root-sponsored floating tone

<sup>9</sup> Hyman & Tadadjeu (1976:61) call floating tones sponsored by a lexical root ‘lexical floating tone’. I do not use this term for the same reason I prefer ‘underlying tone’ over ‘lexical tone’: lexical can be used to mean stored in the lexicon, or to mean as opposed to grammatical. I wish to avoid this terminological ambiguity.

in chapter 3, e.g. with Kabiye [*kbp*] and Urarina [*ura*]. Recall the case of Kabiye (Gur - Roberts 2016), schematically shown below in (35) (see chapter 3 for complete data).

(35)	Underlying tone	/-Ø/	/- <sup>Ⓣ</sup> L/
a.	/H-/	\HH-H\	\H <sup>Ⓣ</sup> -L\
	/H <sup>Ⓣ</sup> -/	\HH- <sup>Ⓣ</sup> L\	\H <sup>Ⓣ</sup> -L\
b.	/L-/	\LL-L\	\L <sup>Ⓣ</sup> -L\
	/L <sup>Ⓣ</sup> -/	\LL- <sup>Ⓣ</sup> L\	\L <sup>Ⓣ</sup> -L\
c.	/HL-/	\HL-L\	\H <sup>Ⓣ</sup> -L\
	/HL <sup>Ⓣ</sup> -/	\HL- <sup>Ⓣ</sup> L\	\H <sup>Ⓣ</sup> -L\
d.	/LH-/	\LH-H\	\L <sup>Ⓣ</sup> -L\
	/LH <sup>Ⓣ</sup> -/	\LH- <sup>Ⓣ</sup> L\	\L <sup>Ⓣ</sup> -L\

In my analysis of these data, there are (at least) 8 root shapes. Kabiye has two tonemes /H/ and /L/, with root shapes with and without floating tones: /H/, /L/, /HL/, /LH/ vs. /H<sup>Ⓣ</sup>/, /L<sup>Ⓣ</sup>/, /HL<sup>Ⓣ</sup>/, /LH<sup>Ⓣ</sup>/.<sup>10</sup> Furthermore, noun roots appear with class/number marker suffixes. These can be unvalued /Ø/ or valued with underlying /H/, /HL/, or /<sup>Ⓣ</sup>L/. In this last type, a floating tone docks to the final TBU of the root. Schematic representations of /-Ø/ and /-<sup>Ⓣ</sup>L/ are in the columns above. When a suffix with no underlying tone appears with a root, the final tone of the root spreads onto it or the final floating docks to it. For example, in (35)b., compare /L/ → \LL-L\ where the toneless affix gets low tone, to /L<sup>Ⓣ</sup>/ → \LL-<sup>Ⓣ</sup>L\ where it gets high tone.

In contrast, look at the last column showing valued /-<sup>Ⓣ</sup>L/ suffixes. What happens here when the floating tones are in competition, so to speak? Here, the floating tone from the root does *not* dock to the suffix, but rather the opposite happens: the floating tone associated with the suffix docks to the root. This therefore neutralizes the difference between the examples in each row, roots with and without floating tone. Other complications exist detailed in Roberts, but none of these additional complications show something like root-sponsored floating tones completely replacing underlying suffixal tone (i.e. a dominant pattern).

I take this as illustrative of the behavior of floating tones on roots: if they assign a tone to a neighboring morpheme (e.g. via floating tone), the pattern is non-dominant. This predicts that any deletion which happens on the outer target-host should be ‘incidental’ in the sense that it is a consequence of general phonological restrictions in the language. We therefore expect to never find the following situation as in Table 13, showing a fake Kabiye-Prime language.

<sup>10</sup> As previously noted in chapter 3, floating tones on lexical roots is my analysis and not Roberts’. He simply renders this /HL/ if the root is monosyllabic and /HHL/ if bisyllabic.

		Root tone	Suffix tone		
			/-Ø/	/-HL/	/- <sup>⊕</sup> L/
a.	i.	/H-/	\HH-H\	\HH-HL\	\H <sup>⊕</sup> -L\
	ii.	/H <sup>⊕</sup> -/	\HH- <sup>⊕</sup> L\	\HH- <sup>⊕</sup> L\	\HH- <sup>⊕</sup> L\
b.	i.	/L-/	\LL-L\	\LL-HL\	\L <sup>⊕</sup> -L\
	ii.	/L <sup>⊕</sup> -/	\LL- <sup>⊕</sup> L\	\LL- <sup>⊕</sup> L\	\LL- <sup>⊕</sup> L\
c.	i.	/HL-/	\HL-L\	\HL-HL\	\H <sup>⊕</sup> -L\
	ii.	/HL <sup>⊕</sup> -/	\HL- <sup>⊕</sup> L\	\HL- <sup>⊕</sup> L\	\HL- <sup>⊕</sup> L\
d.	i.	/LH-/	\LH-H\	\LH-HL\	\L <sup>⊕</sup> -L\
	ii.	/LH <sup>⊕</sup> -/	\LH- <sup>⊕</sup> L\	\LH- <sup>⊕</sup> L\	\LH- <sup>⊕</sup> L\

Table 13: System predicted to *not* exist – Root-sponsored floating tone showing dominant tone

This fake language has the same inventory of tonal shapes for roots and suffixes as real Kabiye, but exhibits different behavior. In this hypothetical system, roots with floating tones (the ii. rows) dock to both unvalued suffixes /-Ø/ but critically also systematically override valued suffixes /-HL/ and /-<sup>⊕</sup>L/ (as shown in the red). In line with previous predictions, such a system is unattested in my survey.

The lack of this system is especially surprising given the following. Root-suffix constructions are more frequent than prefix-root constructions (Bybee, Pagliuca, & Perkins 1990, and references therein). Because root-suffix combinations by definition show a type of close morpho-syntactic/morpho-phonological constituency, this is suitable grounds for the effects of **pitch delay** to be phonologized (also called ‘peak delay’). A good definition of pitch delay comes from Yip (2002):

*“When the brain sends a signal to produce high tone, instructions go to the appropriate muscles. The muscles configure the vocal folds suitably, and the rate of vibration then increases, resulting in high pitch. All this takes a small but finite amount of time, and as a result the full flowering of high pitch is somewhat delayed. **The delay is enough that the peak is typically at the end of the tone-bearing segment, or indeed often not reached until early in the following syllable.** The term ‘peak delay’ is usually used for the latter case”*

[Yip 2002:8, bolding mine]

This is a robust (perhaps universal) property across tonal languages, often manifested as progressive, assimilatory tonal co-articulation. While not instrumental, Hyman & Schuh (1974: 88) were among the first to point out the generalization that tones last too long rather than start early, largely looking at African data. Moreover, Zhang & Meng (2016:172) provide a small sample of the Asian literature detailing pitch delay: Mandarin (Xu 1997), Tianjin (Zhang & Liu 2011), Taiwanese Southern Min (Peng 1997), Malaysian Southern Min (Chang & Hsieh 2012), Vietnamese (Han & Kim 1974, Brunelle 2009), Thai (Gandour, Potisuk, & Dechongkit 1994, Potisuk, Gandour, & Harper 1997), among many others.

What is remarkable is that we would expect the effects of pitch delay to favor floating tones sponsored from the root to incrementally push the affix tones ‘away’ and override underlying tonal contrasts of dependent morphology. However, despite the essential ingredients for root-sponsored floating tone dominance being present, it has yet to be unquestionably demonstrated, which I take to be an important finding.

Parallel facts to the ones seen in Kabiye emerge consistently in a large sample of root-sponsored floating tones. Roberts himself alludes to parallels between Kabiye and completely unrelated systems, describing it in terms of ‘word level tone’:

*“Word level tone, in various guises, is certainly common elsewhere in Africa and beyond. ... Further afield, Donahue (1997), discussing Papuan [languages], draws a typological distinction between syllable-tone languages, in which each syllable may bear a distinctive tone, and word-tone languages in which root tone patterns spread over the whole word, **including toneless affixes**. In Siane, for example, most suffixal and postclitic morphemes are **unspecified for tone** in their underlying representations and take their tones – H, L or LH – from the stem (James 1994: 128). Similar processes are attested in Gadsup (Pennington 2014), Kairi (Newman and Petterson 1990), Mian (Fedden 2012) and Narak (Hainsworth manuscript 1969).”*

[Roberts 2016:142; bolding mine]

It is in fact very common for tone sponsored by a root to appear on a suffix, as long as the suffix is underlyingly toneless. For example, one famous case is Mende in which tones from a noun ‘stretch out’ when a suffix is present.

(36) Mende nouns (Leben 1978)

- |    |     |       |          |
|----|-----|-------|----------|
| a. | H   | kó    | kó-má    |
|    |     | pélé  | pélé-má  |
| b. | L   | bèlè  | bèlè-mà  |
| c. | HL  | mbù   | mbú-mà   |
| d. | LH  | mbǎ   | mbà-má   |
| e. | LHL | nyàhâ | nyàhá-mà |

The suffix *-ma* ‘on’ (or perhaps enclitic) is toneless, taken its value from the previous toneme (a.-b.). If the noun has a contour [ $\widehat{HL}$ ], [ $\widehat{LH}$ ], or [ $\widehat{LHL}$ ] in isolation, the final toneme falls on the suffix resulting in decontouring (or at least non-contouring). This is usually taken as evidence that tone melodies apply to the ‘word’, mapped  $L \rightarrow R$  or  $R \rightarrow L$  regardless of the morphological make-up (i.e. whether bare noun or multi-morphemic). Mende tone is notoriously more complex than this (Shih & Inkelas 2016), but this illustrates the main point.

As stated, in all cases of floating tone sponsored from the root, it is not dominant. This is true in a genetically and geographically diverse sample of languages, summarized in Table 14 below.

Language	[iso]	Family (Location)	Sponsoring Root	Floating tone	Type (Behavior)	Source
a. Urarina	[ura]	Isolate (Peru)	N	Ⓜ	<i>Neutral</i> (dock to toneless V/Adj/PostP)	[Olawsky 2006:122,136]
b. Magdalena Peñasco	[xtm]	Mixtec (Mexico)	N	Ⓜ,Ⓛ	<i>Local replacive only</i> (overrides single local TBU only)	[Hollenbach 2003, 2005]
c. Amuzgo	[amu]	Otomanguean (Mexico)		Ⓛ	<i>Neutral</i> (makes a syllable ballistic)	[Williams 2004]
d. Arapaho	[arp]	Algonquian (USA)	N/V	Ⓜ	<i>Neutral</i> (falls on previous morpheme, numerous patterns)	[Cowell & Moss 2008]
e. Kunama	[kun]	Isolate? (Eritrea)	N	Ⓜ,Ⓛ	<i>Neutral/Local replacive only</i> (docks to following suffix, creates contours, or replaces a single local TBU only)	[Connell et al. 2000]
f. Ganza	[gza]	Mao (Ethiopia)	N/V	Ⓜ,Ⓛ	<i>Neutral</i> (dock to toned suffix, create contour)	[Smolders 2016]
g. Vute	[vut]	Mambiloid (Nigeria)	N	Ⓛ	<i>Neutral</i> (downstep)	[Thwing & Watters 1987:24]
h. Ga'anda	[gaa]	Chadic (Nigeria)		Ⓛ	<i>Neutral</i> (downstep)	[Newman 1971]
i. Mbui	[baw]	Bantoid (Cameroon)	N/V	Ⓛ	<i>Neutral</i> (downstep)	[Hyman & Tadjadjeu 1976]
j. Mituku	[zmq]	Bantu (DRC)	all /H/ V	Ⓛ	<i>Neutral</i> (dock to previous prefix, create falling or downstep)	[Goldsmith 2002]
k. Dembwa	[dav]	Bantu (Kenya)	N	Ⓜ	<i>Neutral</i> (dock to following toneless Adj)	[Odden 2001, 2006]
l. Kabiye	[kbp]	Gur (Togo)	N	Ⓜ,Ⓛ	<i>Neutral</i> (dock to toneless suffix)	[Roberts 2016]

Table 14: Sample of languages with root-sponsored floating tone (all are non-dominant)



This table reveals that root-sponsored floating tone shows non-dominant behavior. In some cases, a floating tone may replace an underlying tone of the target but only in limited way. I refer to this as local replacive behavior, constituting cases in which the floating tone replaces only a single TBU. This is crucially distinct from replace-dominant GT which replaces *all* tonemes within the target domain. I will not formalize how this local replacive behavior happens within the current model. It is sufficient to say at this point that the asymmetry between roots and affixes stands: roots do not show dominance.

Thus, we can say that there is a set of common behaviors which root-sponsored floating tone exhibits. These behaviors can be assessed within specific families, or across languages. The former has been done for example for the Mbam-Nkam family of Cameroon by Hyman & Tadadjeu (1976), while the latter has not been done to my knowledge. A sample of factors that influence the direction of floating tone docking in Mbam-Nkam is below (factors likely extending to all of Grassfields Bantu – Larry Hyman p.c.):

- (37) Floating tone generalizations in Mbam-Nkam family (Hyman & Tadadjeu 1976:62)
- a. **Realization:** assign in direction in which it will have the greatest tonal effect
  - b. **Naturalness:** assign in direction which creates the more natural tonal contour
  - c. **Phonological conditioning:** syllabic structure may determine direction of floating tone docking
  - d. **Grammatical conditioning:** grammatical boundaries may determine direction of floating tone docking

For example, one surface pattern with floating tones often seen is downstep, the result of a floating low tone <sup>Ⓛ</sup>. An example is from the Mbam-Nkam language Mbui [[baw](#)].

- (38) Floating <sup>Ⓛ</sup> resulting in downstep
- a. / bə̀kóó / ‘crabs’  
/ bə̀ndú́m<sup>Ⓛ</sup> / ‘husbands’
  - b. [ bə̀kóó b́ó śə̀ŋ ] ‘the crabs of the bird’  
[ bə̀ndú́m<sup>Ⓛ</sup> b́ó śə̀ŋ ] ‘the husbands of the bird’

[Mbui – Hyman & Tadadjeu 1976:61]

In example (38)a., the first noun has no floating tone while the second does. In [N of N] constructions with the overt linker /b́/ (b.), the form without a floating tone shows a [...HH...] pattern while the second with floating tone shows downstep [...H<sup>Ⓛ</sup>H...]. Such downstep patterns clearly show the retention of the underlying tones of the host, and therefore constitute a neutral pattern. Again, what is *not* found is root-sponsored floating tone which is dominant.

#### 6.4.2 Are there cases of outward dominance?

As defined in chapter 3, **outward dominance** refers to cases where it appears that an inner morpheme is a dominant trigger over an outer morpheme, contrary to expectations. If we found a case of root-sponsored floating tone which was dominant, this would constitute outward dominance. Most cases showing such properties are only **apparent outward dominance**, and do not constitute a true counterexample. One famous case which I classify as apparent outward dominance is from the Shanghai dialect of Wu Chinese [[wuu](#)] (see Chen 2000 and Zhang & Meng 2016 for references of the extensive literature).

One tonological operation of Shanghai Wu is ‘left-dominant sandhi’ which “spreads the tone of the initial syllable across the entire word” (Zhang & Meng 2016:170, following Yue-Hashimoto 1987, Chen 2000, Zhang 2007, 2014). Here, “the tone on the second syllable is

entirely determined by the tone on the first syllable and hence completely loses its contrastive status” (p. 171). An example from Zhang & Meng involves the verb /sã<sup>53</sup>/ ‘hurt’, in (39)a. Here, the /53/ pattern (≈/HM/) of the verb spreads over the entire [VERB OBJECT] construction and deletes the object tones. Another example is given in example (b.) (Chen 2000), in which the verb /paq<sup>MH</sup>/ ‘give’ spreads over the indirect object as well as the pre-nominal modifiers of the direct object.

(39) Apparent outward dominance – Verb over object

- a. /sã<sup>53</sup>/ + /foŋ<sup>53</sup>/ → \sã<sup>55</sup>-foŋ<sup>51</sup>\  
 ‘hurt’ ‘wind’ ‘to catch a cold’
- b. /paq<sup>MH</sup> ngo<sup>LH</sup> yiq<sup>H</sup> pəŋg<sup>MH</sup> si<sup>HL</sup>/ → \paq<sup>M</sup> ngo<sup>∅</sup> yiq<sup>∅</sup> pəŋg<sup>∅</sup> si<sup>HL</sup>\  
 give me one CLASSIFIER book ‘give me a book’
- [Shanghai Wu – a. Zhang & Meng 2016:170, citing Xu *et al.* 1981:151; b. Chen 2000:313]

This has the properties of dominance in that object phrase has material which would be ‘outer’ to the verb (morphosyntactically higher).

This is classified only as apparent dominance because these patterns are attributed to metrical structure. Several researchers have commented on the complex interaction of metrical structure and tone sandhi of this deletion+spreading type. Yip (2002:111) notes “the domains are clearly stress domains, since they can be affected by contrastive stress, and are subject to clash avoidance”. Such a metrical analysis is thoroughly pursued in Chen (2000:306ff.), who argues for the following metrical structure of the Shanghai Wu, in (40).

- (40) Metrical analysis of apparent outward dominance: ( . x )  
 ( x . . . ) ( x )  
 /paq<sup>MH</sup> ngo<sup>LH</sup> yiq<sup>H</sup> pəŋg<sup>MH</sup> si<sup>HL</sup>/ → \ (paq<sup>M</sup> ngo<sup>H</sup> yiq<sup>∅</sup> pəŋg<sup>∅</sup>) (si<sup>HL</sup>) \  
 give me one CLASSIFIER book ‘give me a book’
- [Shanghai Wu – Chen 2000:313]

The lexical items /paq<sup>MH</sup>/ ‘give’ and /si<sup>HL</sup>/ ‘book’ are stressed, while function words are inherently stressless. The stressed lexical words head left-prominent feet to which the function words cliticize. ‘Left-dominant sandhi’ is parasitic on this metrical structure whereby only the underlying tones of stressed syllables are preserved and subsequently spread across the foot (the underlying tone of function words can only be seen in contexts such as contrastive stress).

If this were **true outward dominance**, we do not expect the deletion+spreading pattern to be attributed to metrical structure. Let us briefly discuss criteria that would differentiate between apparent and true outward dominance:

Criterion	Apparent	True
a. Trigger:	<i>Not</i> specific to a natural class of triggers	Specific to a natural class of triggers
b. Position of prominence:	The trigger is in a position of metrical prominence (e.g. stressed) and the target is not	The trigger is <i>not</i> necessarily in a position of prominence
c. Domain of tonological operation:	The domain of the operation is a phonological constituent (e.g. prosodic foot, word, phrase, etc.)	The domain of the operation is <i>not</i> necessarily a phonological constituent
d. Phonological size of trigger/target:	The phonological size of the trigger or target affects the application of the operation (e.g. syllabicity)	The phonological size of the trigger or target does <i>not</i> affect the application
e. Floating tones & self-docking:	Does <i>not</i> lend itself to an analysis with floating tones; self-docking is expected	Lends itself to floating tones; self-docking is <i>not</i> expected

Table 15: Apparent versus true outward dominance

To illustrate, in Shanghai Wu the trigger may be many different types of lexical items, all of which head the left-dominant sandhi domain. They therefore do not constitute a natural class which according to the criterion in row a. makes it look like apparent outward dominance. Likewise, the trigger is in a position of metrical prominence and the target is not (b.), the domain of operation is the foot (c.), the size of the constituents affects the application (d.) (Duanmu 1997), and there is no evidence for a floating tone analysis (e.). Rather the underlying tones of the TBU ‘spread out’ over the domain plus default tones towards the right edge (e.g. /HM/ on one TBU becomes [H M] on two TBUs).

The best cases I have found for true outward dominance are found in noun phrases in several Mande languages. These cases are typologized in Green’s (2018) overview of ‘compacité tonale’ in Mande whereby tonal operations affect one or more constituents in a noun phrase. Typically, the constituent on the right is affected and in several cases this affected constituent is a modifier in a [NOUN MODIFIER] construction. This is seen in languages Liberian Kpelle [xpe] (Welmers 1969), Bandi [bza] (Rodewald 1989), Loma [lom] (Sadler 2006), and Jalkunan [bx1] (Heath 2017). For example in Bandi, it is the tone of the adjective which is overridden, not the nouns. This is shown below:

			/ kòlè / ‘white’	/ kpèá / ‘red’
a.	/ níká /	‘cow’	[ níká wòlé ]	[ níká bèá ]
b.	/ pèsô /	‘pencil’	[ pèsó wòlè ]	[ pèsó bèà ]
c.	/ pèlé /	‘house’	[ pèlé wólé ]	n/a

Table 16: Bandi (Green 2018, adapted from Rodewald 1989:62-69)

Here, the contrastive tone on adjectives (/LL/ vs. /LH/) is neutralized in the context of a noun, e.g. [LH] in row a. compared to [LL] in b.

In the rest of this subsection, I will present the most convincing case of outward dominance I have found: the Mande language Jalkunan [bx1] (Heath 2017). Note, however, that for all of these Mande cases, substantial research is still required to assess whether they represent true

versus apparent outward dominance. I leave this for future study, but stress that they are the most promising set of data which can falsify the theory presented here, and thus should be explored.<sup>11</sup>

Jalkunan has three tonemes L M H which form several noun melodies. A representative list of such melodies are below, illustrated with nouns and their underlying tones.

(41) Melodies on Jalkunan nouns

a.	/L/	bù ‘excrement’	bòʔò ‘ashes’	jòlòkò ‘chain’
	/M/	jū ‘millet’	bāʔā ‘porridge’	tūlūkānā ‘gold’
	/H/	dí ‘child’	jóʔó ‘Jula person’	
b.	/...HL/	kápòn ‘daba (type)’	jókòʔrò ‘face’	tòólò ‘okra’
c.	/...LH/	màkár ‘pity’	sináʔán ‘roselle’	
d.	/...HM <sup>Ⓛ</sup> /	féē ‘calabash’	nínáʔān ‘scorpion’	jàbālā ‘white cowpea’
e.	/H <sup>Ⓛ</sup> /	jí <sup>n</sup> ‘market’	kpésé ‘chewstick’	fóróbó ‘ox’
	/...LH <sup>Ⓛ</sup> /	pòsón ‘poison’	jòʔòmé ‘camel’	
	/...MH <sup>Ⓛ</sup> /	jūfá ‘pocket’	nāmākú ‘ginger’	bòyākí ‘guava’
	/...HLH <sup>Ⓛ</sup> /	dánkùtò ‘nape’	gbélèmá ‘cassava’	

[Jalkunan – Heath 2017]

One type consists of a single tone value, namely all /L/, all /M/, and all /H/, shown in (41)a. Two other types are those which end in /...HL/ (b.) and those which end in /LH/ (c.). The final two types have a floating <sup>Ⓛ</sup> tone which docks to the following morpheme and never to the noun, e.g. on a suffix or a post-nominal modifier. These either end in a HM<sup>Ⓛ</sup> sequence (d.), or end in a H<sup>Ⓛ</sup> (e.).

Nouns can be followed by various modifiers, including suffixes and independent modifiers like adjectives, shown below.

(42)	I	II	III	IV
	Noun	-ra <sup>12</sup>	+ kân-na ‘red’	+ sù máá-na ‘long’
a.	/...L/ jùʔù <sup>n</sup> ‘wrap’	jùʔù-ná	jùʔù <sup>n</sup> kân-nā	jùʔù <sup>n</sup> sù máá-ná
	/...M/ gbāā ‘stick’	gbāā-rā	gbāā kân-nā	gbāā sù máá-nā
	/...H/ yíʔé ‘fish’	yíʔé-rá	yíʔé kân-nā	yíʔé <sup>+</sup> sù máá-nā
b.	/...H <sup>Ⓛ</sup> / kpésé ‘chewstick’	kpésé- <u>rà</u>	kpésé <u>kân-nā</u>	kpésé <u>sù máá</u> -ná ~ (kpésé <u>sù máá-nā</u> )

[Jalkunan – Heath 2017:59]

Nouns which end in /L/, /M/, or /H/ are shown in row a., and have no floating tone. When such nouns appear with a toneless suffix (column II), the value on the suffix is predictable: [H], [M], and [H] respectively. When they appear with post-nominal adjectives (columns III and IV), the adjectives retain their underlying tone, /M/ and /H/ respectively.

In contrast are nouns with a floating tone shown in row b. The floating tone docks to the toneless suffix (II), but also overrides the following underlying tone of the post-nominal modifier (III-IV). If we assume that nouns are inward and adjectives are outward (i.e. modifiers being morphosyntactically higher/upward), then this example would constitute upward dominance.

A complete set of tonal changes is schematized in Table 17 below.

<sup>11</sup> Another potential case of outward dominance involving floating tone is the nearby Senoufo language Supyire [spp] (Carlson 1994), although this has not been analyzed.

<sup>12</sup> The suffix here has unclear semantics.

		1	2	3	4	5	6
Noun	Adjective	/M/ (n=2)	/L/ (n=1)	/H/ (n=5)	/H <sup>⊕</sup> / (n=5)	/HM <sup>⊕</sup> / <sub>1</sub> (n=6)	/HM <sup>⊕</sup> / <sub>2</sub> (n=2)
		kān-nā 'red'	gbò?ò-rá 'black'	súmáá-ná 'long'	gbó-rà 'big'	táā-rà 'hot'	wúdṣ-rò 'new'
a.	/H/	H # M-M	H # L-H	H # H-H	H # H-L	H # HM-L	H # HM-L
	yíṣé 'fish'						
	/M/	M # M-M	MH # L-H	M # H-H	M # H-L	M # HM-L	M # HM-L
	gbāā 'stick'						
	/L <sub>1</sub>	L # M-M	LH # L-H	L # H-H	L # H-L	L # HM-L	L # HM-L
	jùṣṣ 'wrap'						
b.	/L <sub>2</sub>	L # L-H	L # L-H	L # H-H	L # H-L	L # HM-L	L # HM-L
	míṣṣ 'person'						
c.	/H <sup>⊕</sup> /	H # L-L	H # L-H	H # L-H	H # L-H	H # L-H	H # HM-L
	kpésé 'chewstick'						
	/HM <sup>⊕</sup> /	HH # L-L	HH # L-H	HH # L-H	HH # L-H	HH # L-H	HH # HM-L
	kúrū 'boat'						
	/LH <sup>⊕</sup> /	LH # L-L	LH # L-H	LH # L-H	LH # L-H	LH # L-H	LH # HM-L
	tòfá 'brick'						
	/MH <sup>⊕</sup> /	MH # L-L	MH # L-H	MH # L-H	MH # L-H	MH # L-H	MH # HM-L
	mótó 'motorcycle'						

Table 17: Outward dominance - Floating tones on nouns overriding adjectives in Jalkunan

The nouns are in blue to the left and are broken down into tonal groups based on their final tone. Note that the /L/ tone noun /mìʔì<sup>n</sup>/ ‘person’ is exceptional and therefore called /L/2. Post-nominal adjectives are in red at the top and are classified into their inherent tone patterns, which are drawn from the same set of basic melodies (the number count *n* of each class is given, inferred from Heath’s grammar). Changes triggered by the noun onto the adjective are indicated by a change to blue and highlighting the cell in light grey. Independent tonal changes which are phonologically general and *not* due specifically to [NOUN ADJECTIVE] interaction are in black. These largely involve final H tones on the nouns at word boundaries (crudely, a tonological rule that maximizes falls across morpheme boundaries).

Row a. shows that those melodies without a floating retain their underlying tones (in blue), and the adjective also retains its tones (in red). The exceptional /L/ tone noun /mìʔì<sup>n</sup>/ ‘person’ (row b.) causes the following /M/ tone adjective to lower to /L/ (with predictable H on the following suffix), but causes no changes to other adjectives.

In contrast are the nouns in row c., each having a floating low. These trigger an all L pattern on the following /M/-toned adjective (column 1). These cause the suffix attached to the adjective to become low, which is exceptional (these suffixes are consistently non-low otherwise in the paradigm). With the adjectives in columns 3-5 which all begin with H tone, these uniformly change to an all L pattern, followed by [H] on the suffix; column 2 is ambiguous as both the input and output are [L-H]. Finally, column 6 represents two adjectives which never change regardless of the context (they are ‘indomitable’ if these structures are classified as a true dominance effect). Importantly, this table shows that the floating tone sponsored by a noun docks to the following adjective and completely overrides its underlying tones rather than merely replacing a single local TBU, e.g. /kpésé<sup>Ⓣ</sup> + sù máá-na/ → \kpésé sù máá-ná\ (*not* \*kpésé sù máá-ná).

Similar facts are seen with [NOUN NUMERAL] constructions, showing this is not a quirk of the adjectival paradigm.

	/L/	/M/	/H/	/HM <sup>Ⓣ</sup> /	
(43)	Numeral	/kùgù/ ‘stone’	/gbāā/ ‘stick’	/yíʔé/ ‘fish’	cf. /náā/ ‘woman’
a.	1 dúlì	kùgù dúlì	gbāā dúlì	<b>n/a</b>	<b>n/a</b>
b.	2 flā	kùgù flā	gbāā flā	yíʔé flā	náá flā
c.	3 sīgbō	kùgù sīgbō	gbāā sīgbō	yíʔé sīgbō	náá sīgbō
d.	4 nāānī	kùgù nāānī	gbāā nāānī	yíʔé nāānī	náá nāānī
e.	5 sóóló	kùgù sóóló	gbāā sóóló	yíʔé sóóló	náá sóóló
f.	6 mī-īlō	kùgù mī-īlō	gbāā mī-īlō	yíʔé mī-īlō	náá mī-īlō
g.	7 mà-álā	kùgù <b>má</b> -álā	gbāā <b>má</b> -álā	yíʔé <b>má</b> -álā	náá <b>mà-àlà</b>
h.	8 mà-sīgbō	kùgù <b>má</b> -sīgbō	gbāā <b>má</b> -sīgbō	yíʔé <b>má</b> -sīgbō	náá <b>mà-sīgbō</b>
i.	9 má-nānī	kùgù má-nānī	gbāā má-nānī	yíʔé má-nānī	náá má-nānī
j.	10 táā	kùgù tāā	gbāā tāā	yíʔé tāā	náá <b>tàā</b>

[Jalkunan – Heath 2017:93-96]

The numerals 1-10 are provided in this table, shown with nouns of different tonal classes. The patterns are as presented in Heath (2017:93-96). With all /L/, /M/, and /H/ nouns, the tones of the underlying numerals do not change, with the exception that the prefix /mà-/ on 7 and 8 changes to \má-. Compare this to the final column with the /HM<sup>Ⓣ</sup>/ noun /náā/ ‘woman’ where the underlying tones of the numeral are overridden by the floating tone with the exception of 9 /má-nānī/ which does not change.

Note, however, that there is inconsistency regarding tonal effects on numerals. This likely represents phonological variation, especially in light of Heath’s statement that for all numerals

“in careful speech, the underlying non-low tones of the numerals may reappear” in this modificational context (p. 96).

The numerals 7, 8, and 9 are most pertinent. The numeral for 7 is variably given as /mà-álà/ in isolation (cf. /mà-álā/ above). Further, like 9, 7 and 8 resist the floating tone overlay in a secondary discussion of numerals in Heath (2017:136-140), also showing variation. A complete schema is presented in Table 18 below.

	2 /M/	3 /M/	4 /M/	5 /H/	6 /M-M/	7 /L-HL/	8 /L-M/	9 /H-ML/	10 /H/
	flā	sīgbō	nāānī	sóóló	mī-īlō	mà-àlà	mà-sīgbō	má-nānī	táá
a.	/H/	H#M	H#M	H#H	H#M-M	H#H-HL	H#H-M	H#H-ML	H#H
	/M/	M#M	M#M	M#H	M#M-M	M#H-HL	M#H-M	M#H-ML	M#H
	/L/	L#M	L#M	L#H	L#M-M	L#H-HL	L#H-M	L#H-ML	L#H
b.	/HM <sup>Ⓟ</sup> /	HH#L	HH#L	H#L	HH#L-L	HH#L-HL	HH#L-M	HH#H-ML	HH#L
	/H <sup>Ⓟ</sup> /	H#L	H#L	H#L	H#L-L	H#L-HL	H#L-M	H#H-ML	H#L
	/LH <sup>Ⓟ</sup> /	LH#L	LH#L	LH#L	LH#L-L	LH#L-HL	LH#L-M	LH#H-ML	LH#L
	/MH <sup>Ⓟ</sup> /	MH#L	MH#L	MH#L	MH#L-L	MH#L-HL	MH#L-M	MH#H-ML	MH#L

Table 18: Floating tones on nouns overriding numerals in Jalkunan (Heath 2017:136-140)



As in Table 17, the nouns Table 18 are on the left in blue classified by tone class, and the numerals which follow the noun are in red at the top with their underlying tone. Note that numerals 6-9 have a prefix mV- which has underlying tone as well. Row a. shows numerals appearing with their underlying tones, while row b. shows that nouns with floating low override the underlying /M/ of 2-4 and 6, and underlying /H/ of 5 and 10. For numerals 7-9, Heath (2017:139) has a different characterization of the tone behavior than what was previously given above in (43) with the /HM<sup>Ⓣ</sup>/ noun /náā/ ‘woman’. Here, the floating tone does not dock to any part of 9 /má-nāni/ as above, but for 7-8 it either docks vacuously to the L tone prefix or not at all. Importantly, it does *not* override the numeral root tones in either ‘7’, ‘8’, or ‘9’, unlike in the other numerals.

If adjectives and numerals (being modifiers) are in structural higher positions, then Jalkunan presents a serious problem to the theory I have presented in this study. In what follows, I provide a sketch of an analysis which is able to account for these facts in Jalkunan, and thus classify it as only apparent outward dominance.

First, we saw that when the <sup>Ⓣ</sup> sponsored by the lexical root falls on the following word, in at least some instances it does not merely fall on the adjacent TBU, but is ‘greedy’ and docks to more than one. Although there is variation, one pattern stands out: when the host (the adjective/numeral) has more than one tone, the <sup>Ⓣ</sup> only overrides the adjacent one (not both) or doesn’t dock at all. For example, in Table 17 the adjective root in columns 1-4 is overridden (or in the case of column 2 it is ambiguous), e.g. /súmáá-/ ‘long’ → [kpésé súmàà-ná] ‘long chewstick’. In all of these cases, the adjectival root bears only one tone value. It is therefore reasonable to suggest that there is only one toneme which spreads across the entire morpheme. If this is the case, then the floating <sup>Ⓣ</sup> does not simply dock to the host but it replaces the one and only toneme of the adjectival root. In this way, it is also only local replacive.

Next, consider columns 5-6 of /HM/ adjectival roots. These show two patterns: column 5 shows the <sup>Ⓣ</sup> overriding both tonemes, while in column 6 it does not dock at all. Tentatively, I understand this as a ban on [LM] sequences, with a conspiracy as to how to avoid them: deleting both tonemes, or neither.

Numerals show even more evidence that root-sponsored floating tones cannot override more than one toneme. In Table 18, numerals 2-6 (e.g. /sóóló/ ‘5’, /mī-īlō/ ‘6’) and ‘10’ (/táá/) all have a single toneme, which is overridden by the floating tone. In contrast, numerals 7-9 which begin with a prefix /ma-/ are *not* overridden, all of which have multiple tonemes underlyingly, e.g. /mà-àlà/ ‘7’ and /má-nāni/ ‘9’. Again, this shows that the ‘outward dominance’ is limited to a single toneme, which is an atypical property of replacive-dominant GT.

Regardless of analysis, these data reveal that nominal roots for the most part are limited to affecting only over a single morpheme to their right (although note the exception of column 1, and the variation in numerals). This is even clearer with more complex noun phrases:

- (44)
- |    |                                  |   |                         |   |                     |   |   |
|----|----------------------------------|---|-------------------------|---|---------------------|---|---|
| a. | /kpésé <sup>Ⓣ</sup><br>chewstick | + | kpēē<br>white           | + | súmáá-na /<br>long  | → | kpésé [kpèè] súmáá-ná<br>‘long white chewstick’ |
| b. | /kpésé <sup>Ⓣ</sup><br>chewstick | + | táá <sup>Ⓣ</sup><br>hot | + | gbò?ò-ra /<br>black | → | kpésé [tââ] [gbò?ò-rā]<br>‘black hot chewstick’ |

- (45)
- |    |                    |                    |
|----|--------------------|--------------------|
| a. | [ náā-nà ]         | ‘a/the woman’      |
| b. | [ náā jè-ná ]      | ‘a/the good woman’ |
| c. | [ náā jè-ná-à-nū ] | ‘(the) good women’ |

Example (44) shows a [N ADJ ADJ] sequence. With the noun /kpésé<sup>L</sup>-/ ‘chewstick’, the floating tone docks only to the local adjective, and not the second (note that the suffix only appears at the end of the phrase). In (a.) the second adjective appears with its underlying tones, and in (b.) it appears with [M], likely an affect from the first adjective. Crucially, in neither case does it bear a [L] tone which would be expected under ‘outward dominance’.<sup>13</sup>

Further, (45) involves the noun with floating tone /nāā<sup>L</sup>-/ ‘woman’. When this appears with an adjective, it overrides the tones of the adjective root but not the following suffix which appears with default /H/ for this context (as in b.). It is restricted to affecting only the adjectival root in more complex words as well, as in (c.) which appears with plural morphology whose underlying tones are not replaced.

There are several other factors which are relevant to understanding these Jalkunan facts involving general tonological constraints, which we will not be able to explore here (e.g. a ban on \*L#M and \*L#L across morphemes, among many others). As it stands, the matter will remain unsettled whether it is ‘true’ or merely ‘apparent’ outward dominance, and deserves a study in its own right (especially regarding any variation).

### 6.5 Assessing how models handle the ‘scope problem’

To conclude this chapter, let us assess how the model presented here - cophology-scope with Matrix-Basemap Correspondence – compares to other models in the literature with respect to the ‘scope problem’. The scope problem was defined in chapter 4 (along with the ‘origin problem’ and ‘erasure problem’):

- (46) **The scope problem** – how is the scope of the grammatical tune established? how is the target-host determined?

To exemplify this, consider the now familiar data in Kalabari in which all demonstratives are replacive-dominant and assign a LH pattern to nouns, shown below.

- (47) Replacive-dominant GT      / mí<sup>LH</sup> / ‘this’ (neut.)      / mí<sup>LH</sup> ná<sup>LH</sup> / ‘these’  
 HH      / námá / ‘meat’      \ mí námá \      \ mí<sup>LH</sup> ná námá \
- [Kalabari - Harry & Hyman 2014:6]

In this example, the scope problem asks why is the noun /námá/ the target of floating tones and not also the demonstrative (as well as any other morphemes before and after this [DEM N] construction). This is shown below:

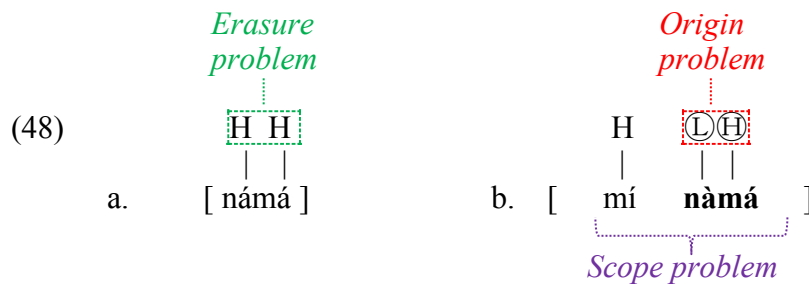

<sup>13</sup> Heath (2017:135) discusses the example in (44)b. saying “one way to think of this is that the suffixal (h) in the l(h) tone of the first adjective does not disappear entirely, rather it partially raises the tone of the second adjective, from l(h) to m(m)”.

Let us begin to assess how different models handle the scope problem. As a first step, there are many different models in the literature seeking to capture dominance effects, with various assumptions, predictions, and target data in mind, and some not actually calling out ‘dominance’ by name. I summarize these models in Table 19 below.

#	Model	My abbreviation	Representative reference
1	Cophonology-scope with Matrix-Basemap Correspondence	<i>CoP</i> -MxBm	[This study]
2	Construction tonology w/ c-command scope	Construction-T	[McPherson 2014, McPherson & Heath 2016]
3	Cophonology Theory with markedness constraints	Marked-CPT	[Inkelas 1998]
4	Antifaithfulness via transderivational correspondence	Antifaith	[Alderete 2001a, 2001b]
5	Lexical MaxEnt with regularization (and scaling)	Regularization	[Gouskova & Linzen 2015]
6	Grammatical tone as tonal allomorphy	T-Allomorphy	[Archangeli & Pulleyblank 2015, Angheliescu et al. 2017]
7	Colored containment via circumfixal floating tones	Circumfixal-CC	[Trommer 2011]
8	Faithfulness to morphological class (Headmost Wins, Root » Affix)	M-Faith	[McCarthy & Prince 1995, Revithiadou 1999]
9	Tonal strength	T-Strength	[Vaxman 2016a, 2016b, Kushnir 2018]
10	Morphemes endowed with [+DELETE] diacritic (‘minor rule approach’)	Diacritic-Del	[Poser 1984, Melvold 1986, Blevins 1993]

Table 19: Alternative theories of dominance

Each of these models involves enrichment of some component of the grammar in order to handle dominance effects, although in radically distinct places. For example, in *CoP*-MxBm (the abbreviation for this section for the model of this study), we enrich the grammar by allowing correspondence to an abstract output (the basemap) and require cyclicity within the morpho-phonological module. While the latter receives wide support from other morpho-phonological phenomena and analyses, the former has yet to be fully developed outside of GT. Thus *CoP*-MxBm enriches (i) correspondence relations mediated by Corr constraints in CON. Enrichment can be in CON in different ways, e.g. by introducing new types of constraints (e.g. Antifaith), or endowing constraints with their scope relations directly (e.g. Construction-T). And enrichment can be in distinct areas of the grammar such as in the lexicon in how and how many morphemes are stored (e.g. T-Allomorphy), and in representational possibilities in the input both qualitatively (e.g. circumfixed floating tones in Circumfixal-CC, a pattern not otherwise attested straightforwardly in GT systems) or quantitatively (e.g. relative strength of morpheme or toneme under M-Faith and T-Strength).

How does each of these models fair with respect to the scope problem? I judge this based on whether they can guarantee the dominant GT asymmetry, a robust typological generalization established throughout this study. I summarize this ability in Table 20.

Model	Ensures dominant GT asymmetry	
	[AFFIX-ROOT]	[DEM NOUN]
a. <i>CoP-MxBm</i>	✓ Yes	✓ Yes
b. <i>Marked-CPT</i>	✓ Yes	✓ Yes
c. <i>Construction-T</i>	✓ Yes	✓ Yes
d. <i>Antifaith</i>	✓ Yes	✗ No
e. <i>T-Allomorphy</i>	✗ No	✗ No
f. <i>Circumfixal-CC</i>	✗ No	✗ No
g. <i>T-Strength</i>	✗ No	✗ No
h. <i>Diacritic-Del</i>	✗ No	✗ No
i. <i>M-Faith</i>	✗ No	✗ No
j. <i>Regularization</i>	✗ No	✗ No

Table 20: Comparison of models with respect to dominant GT asymmetry

The major distinction in ensuring the asymmetry is whether operation scope is an intrinsic part of the model or not. The first three models in a.-c. – *CoP-MxBm*, *Marked-CPT*, and *Construction-T* – all guarantee asymmetry by having **intrinsic scope**, while the models in d.-l. do not.

### 6.5.1 Models without intrinsic scope

Let us first consider those models which do *not* ensure the dominant GT asymmetry because they lack intrinsic scope. First, Antifaithfulness (Alderete 2001a, 2001b) is a theory that captures dominance as an imperative to *not* be faithful to the underlying form, along some phonological dimension. In the privative-culminative tone system of Japanese, Alderete discusses a type of subtractive-dominant types with the suffix /-kko/.

- (49) Subtractive-dominant *-kko*
- |                   |   |                   |                      |
|-------------------|---|-------------------|----------------------|
| / edo –kko /      | → | \ edo-kko \       | ‘native of Tokyo’    |
| / kóobe –kko/     | → | \ koobe-kko \     | ‘native of Kobe’     |
| / nyuuyóoku –kko/ | → | \ nyuuyooku-kko \ | ‘native of New York’ |
- [Japanese – Alderete 2001b:217]

To account for deletion of the tone on the stem, Alderete (2001b:218) posits the following Antifaithfulness constraint, indicated by the negation sign  $\neg$  before the constraint.

- (50)  $\neg$ OO-MAX(Accent)
- For x an accent,  $\neg[\forall x \exists x' [x \in S_1 \rightarrow x' \in S_2 \ \& \ x \mathcal{R} \ x']]$
- (‘it is not the case that every accent in  $S_1$  has a correspondent in  $S_2$ ’)

As indicated in this constraint, Antifaithfulness is framed within output-output correspondence, a point it shares with this study’s model *CoP-MxBm*. Essentially, this constraint  $\neg$ OO-MAX(Accent) in (50) states that the matrix output must *not* have an accent which is present in the basemap output, hence ‘anti’-faithfulness. A tableau using this constraint is below.

Basemap	Matrix / kóobe –kko /	$\neg$ OO-MAX(Accent)	IO-DEP(Accent)	HAVEACCENT
\ kóobe \	a. \ kóobe-kko \	*!		
\ kóobe \	b. \ koobé-kko \		*!	
\ kóobe \	c.  \ koobe-kko \			*

Tableau 1: Subtractive-dominant via Antifaithfulness (Alderete 2001b:219)

Updated to our terminology, the relation here is between a matrix output \koobe-kko\ and a base output \kóobe\, the output of the form in isolation. Candidate a. is fully faithful to the basemap output \kóobe\ and therefore violates the Antifaithfulness constraint  $\neg\text{OO-MAX}(\text{Accent})$ , while candidate b. is not faithful to this basemap output but inserts an accent not in the input violating  $\text{IO-DEP}(\text{Accent})$ . The winner therefore is candidate c. with no accent, which violates the lowly-ranked  $\text{HAVEACCENT}$ <sup>14</sup> (later valued via Japanese-specific default surface rules).

The dominant GT asymmetry thus boils down to a different kind of asymmetry: a free vs. bound morphological distinction. Roots can appear in isolation, and thus their isolation output form can be referenced and exert an influence by virtue of Antifaithfulness. In contrast, affixes do *not* appear in isolation, and thus do not exist and consequently cannot exert such an influence.

At the end of chapter 5, I presented several arguments against Antifaithfulness. Here I will add another: although this model may account for the root/affix distinction, it does not account for modifiers and lexical heads. For example, in the Kalabari case both the demonstrative trigger and the noun target are independent words which can appear in isolation, i.e. \mí námá\. The dominant GT asymmetry does not correspond to a morphological free/bound distinction *above* the word, and thus Antifaithfulness cannot be maintained as is.

The next model in Table 20 above is analyzing grammatical tone as tonal allomorphy (T-Allomorphy), representative work being Archangeli & Pulleyblank (2015). This is a surface-oriented view of morpho-phonology which enriches the lexicon by positing numerous allomorphs for every morpheme:

*“For lexical entries, just as individual sounds and features must be learned, so must the phonological content of individual allomorphs. We hypothesize that this content relates fairly directly to the surface forms: if a morpheme shows up as H toned, it has a H toned allomorph; if it shows up as L toned, it has a L toned allomorph”*

[Archangeli & Pulleyblank 2015]

They exemplify this model with the Bantu language Kinande [nnb] whereby some roots covary with a low-toned prefix (e.g. [kò-] in [ò-kò-gòlò] ‘leg’), while others covary with a high-toned prefix (e.g. [kó-] in [ò-kó-bòkò] ‘arm’). This may be accounted for phonologically by invoking leftward shift of a H tone one TBU left from its sponsoring TBU. In contrast, Archangeli & Pulleyblank account for this by saying that /kɔ/ has two allomorphs {kò} (the default, underlined) and {kó}. Some roots are ‘non-selectors’ and take the default prefix (e.g. the root {gòlò} in the first example), while others are ‘H-selectors’ and select for the high-toned allomorph (e.g. the root {bòkò<sub>H</sub>}, where the subscript <sub>H</sub> indicates what it selects for). Thus, grammatical tone boils down to an enriched lexicon of allomorphs plus extensive selection ( $\approx$ subcategorization).

Let us consider how this theory is inadequate with respect to the Kalabari data. For the output /mí námá/, the target noun would have two (and in fact an extensive set of) allomorphs, {námá} by default and {námá} by selection. The trigger demonstrative would be a LH-selector {mí<sub>LH</sub>}, resulting in the surface pattern [mí námá].

However, this alone does not guarantee the dominant GT asymmetry. Just as certain roots in Kinande idiosyncratically select for a H-toned prefix, we could envision a hypothetical system called Kalabari-Prime in which a set of nouns idiosyncratically select for a LH demonstrative, i.e. {mí} by default but the allomorph {mí} selected in the context of a special root {námá<sub>LH</sub>}. This would result in a situation in which it would appear that certain roots idiosyncratically

<sup>14</sup> I use this placeholder constraint  $\text{HAVEACCENT}$  rather than Alderete’s name for this constraint (‘ $\text{CULMINATIVITY}$ ’), to avoid confusion about the definition of this latter term.

assign a replacive-dominant GT pattern to a demonstrative, i.e. \míí námá\. Such patterns are unattested in my corpus. I therefore conclude that this model does not guarantee the asymmetry. In short, it is well-known that both roots and affixes can idiosyncratically select for allomorphs; however, reducing grammatical tone assignment to allomorphy predicts patterns which are not found.

A similar line of argumentation holds against three other models in Table 20 above: Diacritic-Del, Circumfixal-CC, and T-Strength. I group these together as they seek to account for the difference between dominant and non-dominant patterns by enriching the grammar with a representational difference between the two. In other words, dominant triggers contain some toneme, sequence, feature, diacritic, configuration, *etc.* which is not part of the representation of non-dominant triggers. I refer to these collectively as ‘dominance via representational enrichment’.

Criticism of the first Diacritic-Del (positing a diacritic [+deletion] features) goes back to Inkelas (1998:136), referring this approach as the ‘minor rule approach’ (and citing proponents Poser 1984, Melvold 1986, Blevins 1993). Under this approach, certain morphemes (in our terminology, vocabulary items) bear a [+delete] feature which causes the underlying tones of some set of neighboring morphemes to delete. She distinguishes this approach from a cophonology approach in that Diacritic-Del predicts that any morpheme can bear a [+delete] feature:

*“The cophonology and minor rule approaches are further distinguished by their predictions about the possible triggers of dominance effects. By relating dominance to lexical features, the minor rule approach predicts that any lexically listed morpheme - root or affix - can in principle be associated with the dominance feature and trigger accent deletion from its morphological sisters.”*

[Inkelas 1998:136]

This is problematic given the dominant GT asymmetry and necessity for scope. Inkelas thus asks the following with respect to the diacritic approach:

*“given only a string of morphemes, some of which are specified [+deletion], how is the grammar to know which morphemes are in the scope of the rule triggered by any given deletion feature?”*

[Inkelas 1998:136]

A feature [+delete] by itself has no scope.

Further, under these theories, it is not clear why the outermost element (a modifier/affix) can bear this special representational enrichment, but not the innermost one (e.g. a root, or inner modifier/affix). Consider a model of dominance involving Colored Containment via circumfixal tones (Circumfixal-CC), from Trommer (2011). Under this model, all replacive-dominant grammatical tone is analyzed as a floating tone circumfix, whereby one toneme precedes the target and another follows it. Replacive-dominance arises when tone sponsored by different morphemes are not allowed to be interleaved, namely no three-toneme sequence where the first and last belong to one morpheme but the middle belongs to another morpheme. Trommer frames this under ‘Colored Containment’ theory (van Oostendorp 2006, Revithiadou 2007), with the following constraint:

- (51)  $\square$ CONTIGUITYT (Trommer 2011:126)  
 Assign \* to every tone  $T_1$  which linearly intervenes between two tones  $T_2, T_3$  in P such that  $\text{Color}(T_2) = \text{Color}(T_3) \neq \text{Color}(T_1)$

For example, consider the case of Hausa imperative which is expressed by a replacive-dominant LH pattern (and no segmental exponence). This is shown below with the Hausa verb HLH verb /kàràntá:/ ‘read’.

- (52) Circumfixal-CC  
 Underlying /kàràntá:/ ‘read’ (underlying) + / $\text{L}^- \_ -^{\text{H}}$ / IMPERATIVE  
 In context:  $\text{L}^- \text{H L H} -^{\text{H}}$   $\text{L} \text{H}$   
 /kàràntá:/  $\rightarrow$  \kàràntá:\ ‘read!’  
 [Hausa – Trommer 2011:14,91]

Under the Circumfixal-CC analysis, when the circumfixal floating tone sequence / $\text{L}^- \_ -^{\text{H}}$ / IMPERATIVE combines with the verb, the medial tones from the verb are deleted so as to avoid non-contiguous ‘color’ (i.e. material sponsored from different morphemes).

Trommer presents the following tableau to exemplify this (which I modify to fit the format of comparative tableaux *à la* Prince 2002, Bennett 2013).

	$\text{L}^- \text{H L H} -^{\text{H}}$ /kàràntá:/	$\sigma$ $\uparrow$ T	$\square$ CONT <sub>T</sub>	MAX $\sigma$ $\uparrow$ T	$\sigma$ $\downarrow$ T
a.	$\text{L}^- \text{H L H} -^{\text{H}}$ ↓ ↓ ↓ kàràntá:			3	
b.	$\text{L}^- \text{H L H} -^{\text{H}}$ ↓ ↓ ↓ kàràntá:			(3~3)	W (0~1)
c.	$\text{L}^- \text{H L H} -^{\text{H}}$ ↓ ↓ ↓ kàràntá:		W (0~1)	L (3~2)	
d.	$\text{L}^- \text{H L H} -^{\text{H}}$       kàràntá:	W (0~2)		L (3~0)	

Tableau 2: Dominance via Circumfixal-CC [Hausa - Trommer 2011:91]

Non-dominant candidate d. (in which the floating tones do not dock) violates a constraint  $\sigma \leftarrow T$  in which all tonemes must be linked to syllables. Candidate c. which shows replacement of edgemoest tonemes violates the highly-ranked  $\square$ CONT<sub>T</sub> constraint and is thus eliminated, even though it incurs fewer violations of the more lowly ranked input-to-output faithfulness MAX<sub>T</sub>. Finally candidate b. with mixed replacive/subtractive dominant pattern where the middle syllable is left unlinked violates a constraint  $\sigma \rightarrow T$ .

Like T-Allomorphy, this theory is also inadequate with respect to the Kalabari data. Given that both grammatical elements and lexical roots can sponsor floating tone, there is no a priori reason why they could not both also sponsor floating circumfixal tone. If this is true, then we would predict under Circumfixal-CC that outer material with circumfixal tone can be dominant over inner material, *as well as* predicting that inner material can be dominant over outer material. This is illustrated below with the hypothetical Kalabari-Prime data (based on real Kalabari).

(53) Dominant asymmetry *not* ensured by **Circumfixal-CC** (in hypothetical Kalabari-Prime)

- a. Underlying / mí <sup>Ⓛ</sup>- <sub>-</sub> <sup>Ⓟ</sup> / ‘this’ + / **námá** / ‘meat’
- In context: H <sup>Ⓛ</sup>- **HH** <sup>Ⓟ</sup> → H <sup>Ⓛ</sup> <sup>Ⓟ</sup>  
 / mí **námá** / → \ mí **námá** \ ‘this meat’
- b. Underlying / mí / ‘this’ + / <sup>Ⓛ</sup>- <sub>-</sub> <sup>Ⓟ</sup> **námá** / ‘meat’
- In context: <sup>Ⓛ</sup>- <sup>Ⓟ</sup> **H** **HH** → <sup>Ⓛ</sup> <sup>Ⓟ</sup> **H** **H**  
 / mí **námá** / → \ mí **námá** \ ‘this meat’

Here in a., the demonstrative sponsors a floating <sup>Ⓛ</sup>- <sub>-</sub> <sup>Ⓟ</sup> which results in deletion of the medial tone of the noun via  $\square$ CONT<sub>T</sub>. Equally in b., the hypothetical noun / <sup>Ⓛ</sup>- <sub>-</sub> <sup>Ⓟ</sup> **námá** / ‘meat’ sponsors a floating circumfixal tone which results in dominance over the demonstrative, \ mí **námá** \ ‘this meat’. This pattern contradicts the dominant GT asymmetry and is not attested. Therefore Circumfixal-CC makes the wrong predictions.<sup>15</sup>

Theories invoking different notions of ‘strength’ are equally problematic, e.g. a theory where tonemes are endowed with different ‘activity levels’ as in Kushnir (2018) in the framework of Gradient Symbolic Representations (Smolensky & Goldrick 2016). Kushnir analyzes Lithuanian ‘accent’ (~tone), claiming that “underlying accents can be *strong* or *weak*”, for both roots and affixes:

- (54)
- |                         | <b>Root</b>                                    | <b>Affix</b>                             |
|-------------------------|--|--|
| a. <b>Strong accent</b> | H <sub>1.0</sub><br> <br>/ bú̃t- / ‘apartment’ | H <sub>1.0</sub><br> <br>/ -é̃ / LOC.SG  |
| b. <b>Weak accent</b>   | H <sub>0.5</sub><br> <br>/ nám- / ‘house’      | H <sub>0.5</sub><br> <br>/ -ú / INSTR.SG |

[Lithuanian – Kushnir 2018]

Strong accents are designated as having an ‘activity level’ of 1.0 (denoted as *š*), while weak accents have a level of 0.5 (denoted as *ó*). Kushnir refers to a culminativity constraint (“there is always only one main accent present within a phonological word”), resulting in competition between accents. For example, /kél̃m-aá̃/ with two weak accents maps to \kél̃m-aa\ ‘stump-ACC.SG’ because of higher weight stem faithfulness, but /kél̃m-aí̃/ with a strong accented suffix maps to \kél̃m-aí̃\ ‘stump-NOM.PL’.

Let us assume that with grammatical tone patterns, dominant GT involves strong tonemes with an activity level of 1.0 (e.g. <sup>Ⓟ[1.0]</sup>), while non-dominant GT involves weak tonemes with an activity level of 0.5 (e.g. <sup>Ⓟ[0.5]</sup>). The problem with T-Strength is that there is nothing intrinsic to the theory which would predict the dominant GT asymmetry. We can imagine that both strong and weak floating tones could be sponsored by both outer and inner elements, and thus predict that dominant roots should exist, contrary to fact. This is shown with the Hypothetical Kalabari-Prime system below.

<sup>15</sup> Additionally, see McPherson & Heath (2016:633) for additional criticism against Trommer’s model.



(55) Dominant GT asymmetry *not* ensured by **T-Strength** (hypothetical Kalabari-Prime)

a. Underlying / mí <sup>ⓄⓈ[1.0]</sup> / ‘this’ + / **námá** / ‘meat’

Context: H <sup>ⓄⓈ[1.0]</sup> HH<sup>[0.5]</sup> / mí **námá** / → H <sup>ⓄⓈ[1.0]</sup> \ mí **námá** \ ‘this meat’

b. Underlying / mí / ‘this’ + / <sup>ⓄⓈ[1.0]</sup> **námá** / ‘meat’

Context: H<sup>[0.5]</sup> <sup>ⓄⓈ[1.0]</sup> HH / mí **námá** / → <sup>ⓄⓈ[1.0]</sup> H \ mí **námá** \ ‘this meat’

In example a., the floating tones are strong and the tones of the noun are weak, resulting in a surface form with only floating tones. Equally, in example b. it is the noun which sponsors strong floating tones while the tone of the demonstrative is weak. This results in the unattested root dominance, and thus makes the wrong prediction. Additional arguments against this model are presented at the end of Chapter 5.

Let us now discuss the final two models which also lack intrinsic scope determination. One includes models which rely on faithfulness to morphological classes (M-Faith), such as Revithiadou’s (1999) Headmost Wins, or McCarthy & Prince’s (1995) meta-constraint ROOTFAITH » AFFIXFAITH. Although these theories are important for establishing typological generalizations, it is not true that a dominant trigger must be a head and a non-dominant trigger must *not* be a head. These theories are simply too rigid to handle the breadth of grammatical tone data. Just as for T-Strength, additional arguments against these theories are found at the end of Chapter 5.

Another alternative model of dominance is Lexical MaxEnt with scaling and regularization (whose shorthand here is ‘Regularization’). This is given in Gouskova & Linzen (2015), who describe it as “a framework for analyzing morpheme-specific phonological patterning in Maximum Entropy” (p. 429). Dominance in this model results from a number of logically independent components. First, ‘lexical scaling’ refers to a morpheme-specific effect on a constraint’s weight. For example, a morpheme *m* can have a scaling factor of 10 indexed to a specific constraint; if this morpheme appears in an output candidate and violates this constraint once (a constraint which by default is weighted as 5), then this candidate will actual incur a penalty of 15 (i.e. 10+5). [Note assumptions of harmony akin to Harmonic Grammar - Smolensky & Legendre 2006.] Second, ‘morphological regularization factors’ are also associated with a morpheme *m* indexed to a constraint and regulate the scaling factors by multiplying the scale by a factor between 0 and 1. In our toy example, for a candidate with two morphemes [*m*<sub>1</sub>-*m*<sub>2</sub>] if *m*<sub>1</sub> has a scaling factor of 10, and *m*<sub>2</sub> has a regularization factor 1 (10x1), then *m*<sub>2</sub> triggers no discernable effect. However, if *m*<sub>2</sub> has a regularization factor of 0, then the entire score will be 5+(10x0) = 5 for this constraint. This is also what it would be by default, and thus the presence of *m*<sub>2</sub> ‘regularizes’ the morphological effect (resulting in default phonology).

Let’s exemplify this model with how they account for Japanese dominance effects. In what follows, this is meant to give the bare basics of Regularization, not meant to convey the intricacies of this model. In Japanese, the suffix /-ppó/ ‘-ish’ is dominant and results in deletion of the input tone of the target:

- (56) Dominant GT with /-ppó/ ‘-ish’
- a. /kaze + ppó-i / → \kaze-ppó-i\ ‘sniffly’
- b. /kiza + ppó-i / → \kiza-ppó-i\ ‘snobbish’
- /ada + ppó-i / → \ada-ppó-i\ ‘coquettish’

[Japanese – Kawahara 2015:468]

In a., the suffix /-ppó/ combines with a toneless root and thus keeps its underlying tone in a transparent manner. However in b., the suffix combines with a valued root with tone on the first or second mora. Due to culminativity in Japanese, one of these tones must delete. The ‘winner’ here is the suffix tone.

Gouskova & Linzen account for this as in Tableau 3 below with an input /adá-ppó-i/ ‘coquettish’ from (56)b (tableau modified slightly for expository purposes).

/ adá-ppó-i /	*ACCENT <sub>10</sub>	MAX-ACCENT <sub>0</sub>	<i>h</i>	<i>p</i>	Lexical effect	MAX-ACCENT	
						Scaling	Reg.
a	10 (1v x 10c)	0 ada: ((1v x 0c) + (20s + 10√) x 0r) ppo: (0v)	10	100%		Lex. s 20	Root √ 10
b	10 (1v x 10c)	20 ada: (0v) ppo: ((1v x 0c) + 20s)	30	0%	adá	20	10
c		20 ada: ((1v x 0c) + (20s + 10√) x 0r) ppo: ((1v x 0c) + 20s)	20	0%	-ppó	20	0

Tableau 3: Dominant accent in Japanese (Gouskova & Linzen 2015:448)

Two constraints are shown here – \*ACCENT (weighted 10 by default) and MAX-ACCENT (weighted 0 by default) – followed by the resulting harmony score ( $h$ ) and probability ( $p$ ). The lexical effect of specific morphemes is shown at right separated from the content of the tableau by a three-line boundary. The morphemes /adá/ and /-ppo/ affect the constraint MAX-ACCENT in specific ways.

The winning candidate (a.) is \ada-ppó-i\ with accent on the suffix. Losing candidates either retain accent on the root (b.) or lose both accents (c.). Both candidates (a.) and (b.) violate \*ACCENT once and thus both incur a single violation (1v), which is multiplied by the constraint weight (10c), thus both have a score of 10 (1v x 10c). Next consider the more complex case of MAX-ACCENT, which all three candidates violate. I will walk through each of these candidates in turn.

For each candidate, violations can be separated based on which morpheme they occur within. Here, this will either be the root \ada\ or the affix \-ppo\ (indicated in backslashes to emphasize it is the output). First considering candidate a. \ada-ppó-i\, the root portion \ada\ of the candidate violates MAX-ACCENT once since its underlying accent is deleted (1v). This is multiplied by the weight of the constraint (0c), and scaling factors are added to this. In the lexical effect columns to the right, one can see that each of these lexical morphemes /adá/ and /-ppo/ has a lexical scaling factor of 20 for the constraint MAX-ACCENT. This factor is added to candidates which contain these morphemes. Further, roots as a class have an additional scaling factor of 10. Thus for candidate a., the score (1v x 0c) is added with the lexical scaling factor for the violating morpheme \ada\ (20s) and the root scaling factor is added as well (10√).

Further, note the regularization factor for the suffix /-ppo/ where  $r=0$ . According to Gouskova & Linzen, this works in the following way: when /-ppo/ is present within the candidate, the scaling factor for all morphemes other than the sponsor of the regularization are multiplied by  $r$ . In this case, for the morpheme \ada\ this regularization factor (0r) multiplies the scaling factor (20s + 10√) which is added with the violations (1v x 0c). Hence the final formula in this cell ((1v x 0c) + (20s + 10√) x 0r), which equals 0.

Compare this to the losing candidates. Candidate b. \adá-ppo-i\ preserves root accent. The portion \adá\ does not violate MAX-ACCENT (0v), but \ppo\ does (1v x 0c). To this the scaling factor of 20 associated with \ppo\ is added (20s), resulting in the final formula: ((1v x 0c) + 20s) which equals 20. Critical to Gouskova & Linzen’s analysis, /ppo/’s regularization factor does not apply to itself here. Otherwise, this figure would be multiplied by 0 and incur the same number of violations as candidate a.

Finally, candidate (c.) deletes both root accent and affix accent, and as such is simply the product of the score of candidates a. and b.: violations for \ada\ ((1v x 0c) + (20s + 10√) x 0r) and violations for \ppo\ ((1v x 0c) + 20s), which when added together equal 20. Taken together, the harmony score of candidate a. is lowest and is thus the output candidate of the grammar.

Let’s now see why this model is insufficient in capturing the full range of grammatical tone, especially the dominant GT asymmetry. First, one stipulation which Gouskova & Linzen must assume is that the regularization factor does not affect its sponsoring morpheme (“a given morpheme’s regularization factor never applies to the same morpheme’s scaling factor” p. 446). If regularization  $r$  is valued at 0, this results in deletion of the target’s tones. However, because the regularization  $r$  does not multiply the scaling factor of its sponsor, the *trigger*’s tone is not deleted either. However, it is not clear why regularization does not apply to all morphemes within the relevant domain. In no part of this model does this fact fall out without stipulation. We will see in the next subsection how the model which I have posited (CoP-MxBm) accounts for the fact that the trigger’s tones are not subject to dominant pattern.

Secondly, under dominance, affixes can be dominant but roots are never dominant, a fact which plays a major focus of this study and prominently in Alderete (2001a, 2001b). The type of

dominance present in the Japanese accent case involves dominance resulting from a regularization value of 0. In order to achieve this root/affix distinction, Gouskova & Linzen must assume that roots cannot have regularization factors (“we assume that any morpheme can have a scaling factor, but only affixes may have a morphological regularization factor” p.437). As above, nothing in this model allows this to fall out naturally and it thus must be stipulated. This is unlike the models which have intrinsic scope/intrinsic scope which automatically capture the inertness of roots with respect to dominance.

Third, strictly speaking it is not true that lexical morphemes such as nouns and verbs never result in dominance effects. For example, throughout this study I have highlighted several cases of [N<sub>1</sub> N<sub>2</sub>] constructions which are often noun compounds or possessive/associative constructions. In these cases, one noun is a modifier and the other is a modified noun. The same holds for [OBJECT VERB] constructions in which the object imposes a dominant pattern on the verb, but not vice versa. It is not clear how these facts are captured under the Regularization model.

Finally, it is also unclear how the ‘outer dominance principle’ (introduced in Chapter 3) would be captured by this model. This states that “properties of triggers (e.g. whether dominant, recessive, or neutral) are maintained regardless of the content of the target”, which certain of the data in Gouskova & Linzen contradict (e.g. the Russian prepositional data, albeit not involving dominance). Regardless, with respect to grammatical tone and dominance, it is a robust generalization that the outermost trigger’s properties will ‘win’ over an inner trigger’s. Imagine a hypothetical language Kalabari-Prime with two triggers and three morphemes: a demonstrative trigger /mí<sup>+</sup>ná / ‘these’, a numeral trigger /tárá/ ‘three’, and a noun /bélè/ ‘light’. These morphemes are given in (57)a. below.

(57) Inadequacy of Regularization with hypothetical Kalabari-Prime fake language

- |    |   |         |                                    |
|----|---|---------|------------------------------------|
| a. | / mí <sup>+</sup> ná /                                | ‘these’ |                                    |
|    | / tárá /  | ‘three’ |                                    |
|    | / bélè /  | ‘light’ |                                    |
| b. | / tárá <sub>[r=0]</sub> + bélè /                      |         | → \ tárá <b>bele</b> \             |
|    | ‘three lights’  |         | [tárá <b>bèlè]</b>                 |
| c. | / mí <sup>+</sup> ná + tárá <sub>[r=0]</sub> + bélè / |         | → \ <b>mina</b> tárá <b>bele</b> \ |
|    | ‘these three lights’                                  |         | [ <b>mìnà</b> tárá <b>bèlè]</b>    |

Imagine that the grammatical modifiers /tárá/ ‘three’ has a regularization factor of 0 indexed to a constraint MAX-TONE (weighted 0, as in Tableau 3 above). In example (57)b., the regularization factor multiplied by a scaling factor will result in a product of 0, and consequently tone will be deleted by *all* morphemes other than the trigger /tárá/. In b., this results in the noun /bélè/ mapping to \bele\ without tone, which is filled in by low tones in the surface form [tárá bèlè]. The important case is in c. Here, because the regularization factor affects all relevant morphemes within the domain, it will also neutralize the tone of the *outer* modifier /mí<sup>+</sup>ná/ → \mina\ (surface [mìnà]). This would constitute outward dominance (discussed in section 6.4.2), which we determined is marginal/unconfirmed at best, and non-existent at worst.

Again, this is because of the lack of any intrinsic scope/intrinsic cyclicity present in Regularization. Thus, criticism that can be levelled against Regularization is of the same type which Inkelas (1998) levelled against Diacritic-Del models involving a [+delete] feature (as discussed above): “how is the grammar to know which morphemes are in the scope of the rule triggered by any given deletion feature?” (p.136). Lexical MaxEnt and Regularization show great promise in being able to handle morpheme-specific effects on morpho-phonological behavior

(e.g. the Russian preposition data alluded to), but as it stands its extension to dominance effects makes the wrong predictions and should not be adopted as such.

### 6.5.2 Comparing models with intrinsic scope

This thesis has forwarded an analysis of dominance involving Matrix-BaseMap Correspondence (CoP-MxBm) and we have spent considerable time detailing the role of cophonology-scope in it as well. I will not repeat these arguments here. The CoP-MxBm model has relied heavily on Inkelas' (1998) Cophonology Theory with markedness constraints (Marked-CPT) to account for dominance. Both of these have intrinsic scope by virtue of having cyclicity and obligatory inheritance built into their fabric. Further, McPherson's (2014) model of Construction Tonology with c-command scope (Construction-T) also has intrinsic scope. Although McPherson assumes a non-cyclic model of phonology, the constraints themselves refer directly to hierarchical syntactic structure and as such also 'builds in' scope. A representative constraint 'X ADJ' is defined as the following:

(58) X ADJ: Words c-commanded by an adjective take {L} tone

[Tommo So - McPherson 2014:78]

Given that all three have intrinsic scope, we now compare them assessed against additional criteria.<sup>16</sup>

Let's begin by discussing the Marked-CPT approach. Inkelas proposes a model of dominance couched in a cophonology approach within Sign-Based Morphology (Orgun 1996). Within this item-and-process approach to morphology (Hockett 1954), both linear morphology (e.g. affixes) and non-linear morphology (e.g. replacive tone) are the result of a function  $f$  which takes as its input a stem and outputs a morphologically modified word which fits the target semantics. In this way, "the cophonology of a construction is the function which relates the phonology of the mother node to the phonology of its daughter(s)" (Inkelas 1998:128).

This is (potentially) quite distinct from the general item-and-arrangement approach advocated in my study, i.e. implementing cophonology theory within Distributed Morphology. Consider the data below from Hausa:

(59) Approach to morphology with functions  $f$  [Hausa - Inkelas 1998:138]

$$f_{-unaa} \left( \begin{matrix} L & H \\ r\grave{i}g\acute{a}\acute{a} \end{matrix} \right) = \begin{matrix} H & H & L \\ r\acute{i}g\acute{u}n\grave{a}\grave{a} \end{matrix}$$

The stem noun /rìgáá/ 'gown' is /LH/ underlying. When it is selected by a function  $f_{-unaa}$  to express plurality, it is marked with a replacive-dominant H tone pattern and appears with the 'suffix' string /únàà/ PLURAL, resulting in a surface form [rígúnàà] 'gowns'. In order to achieve the replacive-dominant pattern, in the cophonology of this function Inkelas posits a highly ranked markedness constraint TONE=HL, which is crucially ranked above a faithfulness constraint FAITH(Tone). This is illustrated in the tableau below. Here, the winning candidate satisfies the markedness constraint enforcing a HL pattern, at the cost of violating lower ranked faithfulness.

---

<sup>16</sup> Note that in order to achieve intrinsic scope, McPherson directly refers to c-command scope relations in syntax. I presented arguments in Chapter 4 why I have chosen an indirect reference model and refer the reader to that discussion.

- <i>unaa</i> dominant cophonology	L H / rìgáá / 'gown-pl'	MARK		»		FAITH	
		TONE=HL	ALIGN-R (stem, - <i>unaa</i> ),			FAITH(Tone)	
a.	☞	H H L \ rìgúnàà \					*
b.		L H L \ rìgúnàà \	*!				

Tableau 4: Dominance via Markedness » Faithfulness [*Hausa* – Inkelas 1998:140]

We can summarize this approach to dominance as MARK » FAITH (or M » F). We can compare this to the cophonology approach I advocated for where dominance is  $O_{MX}O_{BM}$  » FAITH (or OO » IO). Here, markedness plays no role at all, and rather dominance is attributed to a special kind of faithfulness (correspondence to a basemap output).

It is difficult to fully compare the two models given the very different assumptions regarding what can go in the input and what constraints look like. The *CoP-MxBm* model enriches the content of the input by including affixes and floating tones in the linear string, which results in non-linear morphology in the output. In contrast, the Marked-CPT model as I understand it enriches the contents of constraints whereby all morphological modification is due to constraints, e.g. ALIGN-R(stem, -*unaa*) which amends the string /-*unaa*/ to indicate plurality.

Despite these differences, I find two reasons to support the model I have proposed over Marked-CPT. First, this model is couched within Sign-Based Morphology and intimately tied to word construction. As such, it is unclear how it extends to phrase-level morpho-phonology. We have established throughout this study the clear parallels between word-level and phrase-level dominance effects with respect to GT, and have adopted a non-Lexicalist Distributed Morphology approach in response where such parallels are expected. For example, with the real Kalabari data we have been looking at involving a demonstrative trigger /mí/ ‘this’ and a noun target /námá/ ‘meat’ resulting in \mì námá\, what would the appropriate function look like? Potentially this could look like  $f_{mi}(námá) = mí námá$ , and if so, where would the line be drawn between form-meaning pairings which are due to being stored as items in a lexicon and those due to functions? This would seem to be particularly difficult with dominant GT patterns seen in [OBJECT VERB] constructions. In total, then, evaluating these two approaches to dominance actually ties into a larger debate about the very substance and mechanics of morphology itself.

There is another reason why I do not pursue a markedness-based approach: grammatical tone as a whole is completely orthogonal to markedness. The output of grammatical tone may be more marked or less marked than the input. Thus, GT is neither conditioned nor blocked by markedness. This was discussed in Chapter 3, such as with depressor consonant/tone interaction or tone patterns banned in lexical items but found extensively as grammatical tone patterns (e.g. all H in Esan or all L in Tommo So).

This markedness approach resembles that of templatic morphology, e.g. of the Semitic and Yokuts/Yawelmani type. Markedness constraints ranked high can be used to derive surface templates, e.g. in Modern Hebrew a noun such as /telegraf/ ‘telegraph’ is converted to a verb [tilgref] ‘to telegraph’ by fitting it into a [(C)CiC(C).CeC] template. This can be captured via highly ranked markedness constraints OUTPUT= $\sigma\sigma$  (and COINCIDE-i/e) above faithfulness (Inkelas 1998, citing data in Bat-El 1994). However, in many of these cases, the output template is explicitly *less* marked than the input. For example in Chukchansi Yokuts [*yok*], Guekguezian (2017) argues that the “templatic morphology is the appearance of optimal prosodic structure” (p. 82) which can be understood as an ‘emergence of the unmarked’ effect (TETU - Prince & Smolensky 1993, McCarthy & Prince 1994). In contrast to these, the grammatical tone patterns I

have presented exhibit no such TETU effects in a straightforward manner, and thus I find their relation to markedness questionable in general.

Another problem with Marked-CPT is one shared with McPherson’s (2014) construction tonology (Construction-T). Under both of these alternatives, it is not clear why the grammatical tune does not also scope over the trigger, in addition to the target. The real Kalabari data from (47) are repeated below:

- (60) Replacive-dominant GT     / mí<sup>LH</sup> / ‘this’ (neut.)     / mí<sup>LH</sup> ná<sup>LH</sup> / ‘these’  
 HH     / námá / ‘meat’     \ mí námá \     \ mí<sup>LH</sup> ná námá \

Here, the trigger is the demonstrative /mí/ ‘this’ or /mí<sup>LH</sup> ná/ ‘these’, the target is the noun /námá/, and the grammatical tune is <sup>LH</sup>. In both of these cases, the tune replaces the underlying tone of the noun but does *not* affect the tone of the demonstrative which retains underlying tone. Why is this the case?

In chapter 3, we called this ‘self-docking’, defined as situations where the grammatical tune docks to its sponsor. This is relatively rare, with several researchers discuss constraints against it and similar phenomena involving accent. Revithiadou (1999:54) adopts a constraint \*DOMAIN which states that “lexical accent should not be associated to the morphological domain that sponsors it”, adapting it from Carleton & Myers’s (1996) work on Chichewa GT (Revithiadou 1999:75-80). Analogous constraints were later proposed for analogous phenomena, e.g. the ‘no tautomorphic docking’ problem in Wolf (2007:316), the ‘incest taboo problem’ in Trommer (2011:10), and constraints against ‘self-control’ in GT in the Dogon family (McPherson 2014:89). We will return to this last case below.

Under the approach advocated for here under *CoP-MxBm*, the lack of self-docking is attributed to how floating tones are mapped. Consider the condensed input-output mapping of this example below, provided in the format given throughout Chapter 5 describing Matrix-Basemap Correspondence.

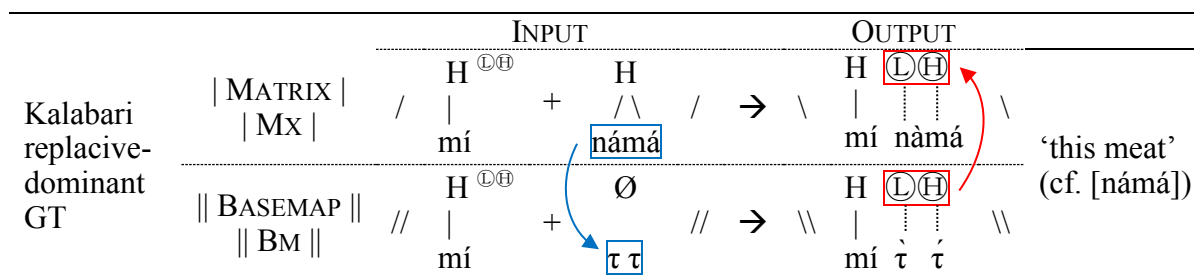

Figure 17: Replacive-dominant GT via Matrix-Basemap Correspondence

Under MxBM-C, the input-output mapping that is being influenced is called the matrix derivation while the input-output mapping that is exerting an influence is called the basemap derivation (equivalent to the ‘base’ in OO-Corr literature). The matrix input in the top left consists of the trigger /mí/ ‘this’, the grammatical tune <sup>LH</sup>, and the target /námá/ ‘meat’. Dominance is the result of this trigger subcategorizing for correspondence to an abstract basemap called an induced basemap, //mí<sup>LH</sup> + ττ// (the blue arrow in the figure).

It is here that we can understand why the tune does not replace the trigger. Deletion of the target tones is *not* due to tone competition between the trigger and target, but rather is due to the basemap induction which extracts common structure from a deficient projection (see Chapter 5 for terminology and details). The common structure of the set of nouns in (61)a below is the structure //mí<sup>LH</sup> + ττ// (in b.).



- (61) Replacive-dominant GT
- a. / mí<sup>Ⓣ</sup> + ná má / ‘this meat’  
 / mí<sup>Ⓣ</sup> + pù lò / ‘this oil’  
 / mí<sup>Ⓣ</sup> + bé lè / ‘this light’  
 / mí<sup>Ⓣ</sup> + gà rí / ‘this garri’  
 / mí<sup>Ⓣ</sup> + ðá<sup>ˀ</sup> rá / ‘this hand’
- b. // mí<sup>Ⓣ</sup> + ττ // ‘this \_\_\_\_’

As shown in Figure 17, this results in a basemap input-to-output mapping //mí<sup>Ⓣ</sup> + ττ// → \\mí + ττ\ transparently. It is *this* structure which is then carried over into the matrix output via output-output correspondence.

Ultimately, the reason why a dominant grammatical tune does not delete the trigger’s tones is that this would be an egregious deletion violating IO faithfulness. If a floating tone is sponsored by a morpheme, the floating tone docks to an unvalued TBU. This both satisfies markedness constraints against unvalued TBUs and undocked <sup>Ⓣ</sup>, and avoids unnecessary faithfulness violations.

Let’s compare this to Marked-CPT. Inkelas (and her predecessors - Halle and Mohanan 1985:68) were well aware of the issue of what we might call ‘universal trigger indomitability’. For example, she discusses the case of a dominant affix covarying with a grammatical tune, asking “what ... guarantees that the constituent undergoing deletion is the base of affixation, not the affix itself?” (p. 137). Inkelas addresses this issue based on the mechanics of the Sign-Based Morphology framework, in which the triggering affix is simply not in the input and thus its ‘underlying tone’ cannot be deleted (as described above in and around example (59)). Thus, only the target is subject to the highly ranked markedness constraint enforcing dominance, e.g. TONE=HL. Under the item-and-arrangement view promoted here in which triggering affixes *are* real objects in the input, it is not clear how they would avoid being subject to the markedness constraint. However, employing an OO-correspondence constraint circumvents this issue entirely.<sup>17</sup>

Moving to the Construction-T approach, McPherson is also well aware of the issue of ‘universal trigger indomitability’. Because she appeals directly to c-command to define the scope of the grammatical tune, this issue is especially problematic: terminal heads c-command themselves, and thus a trigger should c-command itself, therefore predicting that the grammatical tune of a trigger should also override its own underlying tones.

She invokes a constraint \*SELFCONTROL to account for this issue:

- (62) \*SELFCONTROL (McPherson & Heath 2016:621):  
 Assign a violation to any controller [=trigger] that takes its own overlay [=tune]

In most of the Dogon languages surveyed by McPherson & Heath, \*SELFCONTROL is ranked sufficiently high such that the trigger is not affected, but in Tommo So and Ben Tey there are tone construction constraints ranked higher and thus violations can be seen (p. 630).

Although there is clear cross-linguistic support for a constraint like this, it is not clear how this would fall out from McPherson’s analysis. Why is a constraint against self-docking such a common occurrence across languages? A straightforward functional reason would be that if such

<sup>17</sup> It’s worth mentioning that to capture something like the dominant GT asymmetry, even under the *CoP-MxBm* approach involving OO-correspondence, we must state that the outermost element within the domain controls the cophology of the entire cycle, i.e. in a [ROOT-AFFIX] the affix controls the cophology and not the root. Further research should be done to see if the root can ever control the cophology.

a constraint did *not* exist, then the grammatical tune sponsored by a trigger-sponsor would *always* effectively overwrite its own underlying tone. Thus, there would be no discernable context where the trigger’s underlying tone value would be seen. Despite a straightforward functional motivation, we still want to guarantee the recurrence of this constraint based on the mechanics of the model. As described above, under the *CoP-MxBm* model, the reason why the trigger is not subject to the grammatical tune is due to the normal transparent docking of floating tones; no constraint akin to \*SELFCONTROL is required, and thus *CoP-MxBm* has an advantage.<sup>18</sup>

One aspect of grammatical tone bears further discussion as it presents complications for *CoP-MxBm*: inner triggers winning out over outer triggers, in contradiction to the outer dominance principle established in Chapter 3. McPherson & Heath (2016) refer to this situation as a ‘hierarchical reversal’, and use them as key evidence for their global theory without cyclicity. Let’s explore this model and how hierarchical reversals fall out from it, as it poses a major challenge to the *CoP-MxBm* model.

When multiple replacive-dominant triggers occur in the same domain in Dogon, in almost all cases the outer trigger ‘wins’ and imposes its pattern over the inner trigger. An example of a hierarchical reversal is from Ben Tey [dbt]:

- |      |    |  |   |                                      |
|------|----|--|---|--------------------------------------|
| (63) | a. | / ìnjě + <sup>L</sup> mùú /                      | → | \ ìnjè mùú \                         |
|      |    | dog this.AN.SG                                   |   | ‘this dog’                           |
|      | b. | / yǎ-m <sup>HL</sup> + ìnjě + <sup>L</sup> mùú / | → | \ yǎ-m ìnjè mùú \                    |
|      |    | woman-AN.SG dog this.AN.SG                       |   | ‘this dog of a woman’ [belonging to] |

Demonstratives in Ben Tey are dominant triggers which assign L tone to the target, as in (63)a.<sup>19</sup> Alienable possessors are dominant triggers, as seen in b. where the possessor assigns a HL grammatical tune to the noun. This example b. shows that when both triggers co-occur – the inner trigger (possessor) and the outer trigger (demonstrative) – it is the *inner* trigger whose grammatical tune surfaces and blocks the application of the grammatical tune. This case is unexpected given a cyclicity approach: what would block the application of the outer trigger in the later cycle?

I contend that these data are not a fatal flaw of the cyclic model. First, these hierarchical reversals are extremely limited in my survey of grammatical tone and largely limited to one Dogon construction, a fact noted by McPherson herself: a syntactically lower possessor (the inner trigger) competing with a higher non-possessive (the outer trigger). It is not clear why this would be so rare without intrinsic *cyclicity* (not just intrinsic scope).

Second, a correlate of all these cases of hierarchical reversals is that the inner trigger constitutes a phase. A tableau from McPherson & Heath illustrate this below, using the example from Ben Tey in (63)b.

---

<sup>18</sup> This actually flips the issue on its head: what allows the floating tones to dock to the trigger and potentially replace its tones completely? I will not address this issue here, but note that how floating tones dock depends on the grammar and is subject to general markedness constraints. In many cases, in fact, floating tones *do* dock to their sponsor under specific conditions. A full exploration of this issue is required, especially whether there are real differences between how floating tones behave and how replacive tones with respect to their morpheme sponsor.

<sup>19</sup> I indicate this as a superscript <sup>L</sup> *without* a circle in order to not imply that these are definitely floating tones; McPherson explicitly rejects this proposal.

/ $\boxed{\text{y}\check{\text{a}}\text{-m}}_{ph}^{HL} + \text{inj}\check{\text{e}} + {}^L \text{m}\grave{\text{u}} /$		Phase-Faith	Inner	Outer	Faith
		ID-PHASE(T)	POSS ${}^T X$	$X^L$ DEM	ID(T)
a.	$\text{y}\check{\text{a}}\text{-m} \text{inj}\check{\text{e}} \text{m}\grave{\text{u}}$	<i>Inner trigger tune + phase-protection</i>		**	*
b.	$\text{y}\check{\text{a}}\text{-m} \text{inj}\check{\text{e}} \text{m}\grave{\text{u}}$	<i>Outer trigger tune + phase-protection</i>	*!	*	*
c.	$\text{y}\grave{\text{a}}\text{-m} \text{inj}\check{\text{e}} \text{m}\grave{\text{u}}$	<i>Outer trigger tune</i>	*!		**
d.	$\text{y}\check{\text{a}}\text{-m} \text{inj}\check{\text{e}} \text{m}\grave{\text{u}}$	<i>No tune</i>		**	

Tableau 5: Hierarchical reversal [Ben Tey – McPherson & Heath 2016:619]

McPherson argues that possessors constitute separate phases (Chomsky 2001), which are spelled-out separately from the rest of the morphemes. In this case, the phase-protected constituent is the possessor /yǎ-m/ ‘woman’, protected via a special phase-faithfulness constraint ID-PHASE(T). In the input in the tableau, its status as a phase is indicated by boxing it and a noting it with a subscript *ph*.

The winning candidate shows that the inner trigger’s tune wins, and that the inner trigger is phase-protected. In contrast, the candidate b. shows the *outer* trigger’s tune winning which violates the higher ranked construction constraint POSS  ${}^T X$ . Further, candidate c. is eliminated because it violates phase-faithfulness, and candidate d. is eliminated as it satisfies neither the inner or outer trigger.

One fact stands out: it is *only* those triggers which are phase-protected which also show hierarchical reversals (which McPherson confirms p.c., at least for Dogon). It is not clear how this falls out from anything in the Construction-T model. Thus, in the Dogon typology which McPherson & Heath provide there are no straightforward cases of phase-faithfulness ranked low and also exhibiting some type of hierarchical reversal (e.g. a constraint ranking  $X^T \text{Trig}_{IN} \gg X^T \text{Trig}_{OUT} \gg \text{ID-PHASE}$ ).

Given this, I reanalyze McPherson’s data not as a hierarchical reversal but rather as faithfulness to the constituent consisting of the phase (the possessor) *and* its lexical head (the noun). We may understand this as a type of phase-faithfulness if we assume that this entire constituent is somehow phase-protected (or at least some phase-like constituent). This reanalysis is shown below in (64)c.

- (64) a. /  $\text{y}\check{\text{a}}\text{-m}^{HL} + \text{inj}\check{\text{e}} + {}^L \text{m}\grave{\text{u}} /$  → \  $\text{y}\check{\text{a}}\text{-m} \text{inj}\check{\text{e}} \text{m}\grave{\text{u}}$  \  
 woman-AN.SG dog this.AN.SG ‘this dog of a woman’ [belonging to]  
 b. McPherson & Heath: /  $\boxed{\text{y}\check{\text{a}}\text{-m}}_{ph}^{HL} + \text{inj}\check{\text{e}} + {}^L \text{m}\grave{\text{u}} /$   
 c. My reinterpretation: /  $\boxed{\text{y}\check{\text{a}}\text{-m}^{HL} + \text{inj}\check{\text{e}}}_{ph} + {}^L \text{m}\grave{\text{u}} /$

Sub-example b. represents McPherson & Heath’s analysis, justifying their interpretation of this as a hierarchical reversal. In contrast in c., I claim that the phase-protected sub-constituent is larger, and thus this constitutes only an apparent hierarchical reversal. In this case, the inner trigger’s grammatical tune is only *incidentally* preserved.

As discussed in Chapter 3, this phase-faithfulness is one of many cases of exceptional non-undergoers under dominant GT which I called **GT indomitability**:

- (65) **GT indomitability**: the exceptional behavior of certain GT targets which fail to undergo a tonological operation, despite their being a target of the trigger

There are multiple subtypes of indomitability which include morphemic indomitability (exceptional non-undergoing morphemes), morpho-syntactic indomitability (non-undergoing

morphosyntactic constituents, such as a phase), and tonological indomitability (non-undergoing tonological inputs, e.g. don't change HL inputs).

Indomitability of these types requires a special type of faithfulness, analogous to the phase-based faithfulness presented by McPherson, or to the special output-output correspondence presented in my study (faithfulness to an abstract basemap output). There is an extensive literature related to how special faithfulness should be modeled (e.g. Ito & Mester's 1995 work on Japanese; Hsu & Jesney's more recent (2016, 2017) work on 'Weighted Scalar Constraints'; etc.). What is important to take away is that separate from these hierarchical reversal data, we independently require a model which allows special highly-ranked faithfulness constraints.

## 6.6 Summary

The goal of this chapter was to support the claim that the scope of dominant GT patterns is established at spell-out, via the operation hierarchy exchange. Vocabulary insertion maps terminal syntactic heads to vocabulary items with phonological substance, i.e. the string of { } bundles. Hierarchy exchange translates a hierarchical syntactic structure (created by cyclic application of Merge) to a morpho-phonological tree and connects these vocabulary items at binary nodes. Informally, this operation exchanges syntactic notions of 'upward' and 'downward' for morphological notions of 'outward' and 'inward'. The most embedded elements of the syntactic tree are also the most embedded elements within the morpho-phonological object, i.e. roots/lexical heads. Higher heads and specifiers which merge with the lexical head are mapped to 'outer' positions within the morpho-phonological tree.

Hierarchy exchange thus preserves the inside-out derivational history of the syntactic module by referencing asymmetrical c-command. In this way, I conclude that interface models which appeal to c-command are essentially correct, the most relevant being McPherson (2014) and McPherson & Heath (2016). However, I differ from their direct reference models in that the model I propose refers to c-command only indirectly, mediated by hierarchy exchange.

The main function of hierarchy exchange was said to establish cophonology-scope (an extension of 'stem scope' – Inkelas & Zoll 2007). Individual nodes connecting vocabulary items within the morpho-phonological tree are denoted with *CoP* standing for cophonology-scope, subject to the *CoP*-scope hierarchy whereby VIs corresponding to syntactic specifiers scope over heads, and VIs from heads scope over complements. For dominant GT, the scope of the grammatical tune will be the sister of the trigger in the morpho-phonological tree. Lexical heads do not impose a dominant GT pattern onto an outer affix or modifier because the latter are not within the cophonology scope of the lexical head. In this way, all dominance is inward. Cases of true outward dominance (if they exist) would falsify this theory, and the interested critic should pursue them.

A key advantage of Cophonology Theory is that it has intrinsic scope built in by virtue of applying cyclically, an advantage which carries over to Matrix-Basemap Correspondence with cophonology-scope. This effectively guarantees the dominant GT asymmetry and predicts the lack of outward dominance in GT patterns. The majority of other patterns either do not make this prediction at all, or do so only by stipulation. Three models have intrinsic scope and thus guarantee the dominant GT asymmetry: the one presented here, cophonology theory with markedness constraints (Inkelas 1998) and construction tonology with direct reference to c-command (McPherson 2014, McPherson & Heath 2016). I compared the strengths of each of these, and concluded that the model here accounts best for the fact that the trigger itself is not affected by a dominant grammatical tune.

# **Chapter 7**

## **Summary**

## 7.1 Summarizing dominant and non-dominant GT: A return to our three problems

In the preceding chapters, I established a typology and theory of grammatical tone (GT). GT was defined as a tonological operation which is not general across the phonological grammar, and is restricted to the context of a specific morpheme or construction, or a natural class of morphemes or constructions. I framed grammatical tone in terms of dominance effects, dividing GT into replacive-dominant and subtractive-dominant on the one hand, and recessive-non-dominant and neutral-non-dominant on the other. Dominant GT systemically deletes the underlying tone of the target (with or without revaluation by a grammatical tune), while non-dominant GT does not systemically delete it. From a cross-linguistic survey of GT, I developed a typological principle called the dominant GT asymmetry. This states that within a multi-morphemic constituent, the dominant trigger is a dependent (e.g. a modifier of affix), while the target is a lexical head or a dependent structurally closer to the lexical head. In this way, dominance is always inward and outward dominance is predicted to always be amenable to counter-analysis.

In developing a model for dominant vs. non-dominant GT, I established three problems: the origin problem (where does the grammatical tune come from?), the erasure problem (why do the underlying tones of the target go unrealized?), and the scope problem (what determines where the grammatical tune docks, i.e. its scope?). I repeat our familiar data below (taken from chapter 4 on Kalabari):

- (1)    n<sup>á</sup>má +      wá<sup>↓</sup>rí +      améè      →      n<sup>á</sup>má wá<sup>↓</sup>rí améè  
          animal      house      PLURAL      ‘the animal(’s) houses’

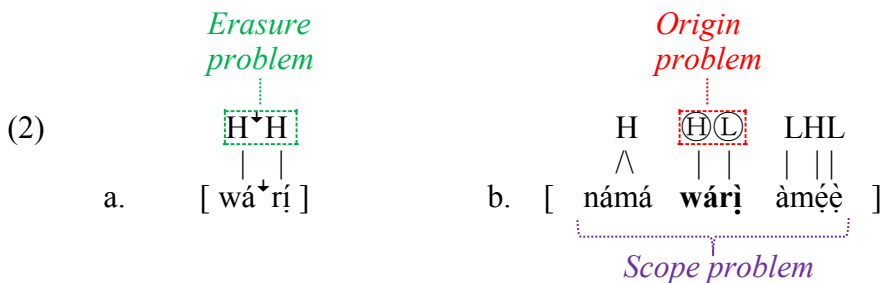

In the [N<sub>1</sub> N<sub>2</sub> PL] sequence in (1), the underlying tones of N<sub>2</sub> go unrealized (as seen in isolation in (2)a [H<sup>↓</sup>H]), replaced with a HL sequence (the grammatical tune).

I developed a model for such data called Matrix-Basemap Correspondence (MxBM-C) and combined it with the notion of cophonology-scope (*CoP*-scope). MxBM-C is an extension of Output-Output Correspondence (OO-Corr - Benua 1997) while *CoP*-scope is an extension of stem scope within Cophonology Theory (CPT - Inkelas & Zoll 2007). Under the proposed model, the origin problem is attributed to floating tones which are part of the underlying representation of the trigger. A major claim is that there is no difference between the representation of dominant and non-dominant tonal effects: both involve floating tonemes undocked to a TBU in the input. In this Kalabari case in (2), the trigger would be an abstract grammatical morpheme /<sup>⊕</sup>L/ [ASSOCIATIVE]. I implement my model within Distributed Morphology (Halle & Marantz 1993), and thus triggers are not constructions but individual vocabulary items (VIs). The VI for the [ASSOCIATIVE] morpheme is below:

- (3)
- {

Dominant trigger

[ASSOC]

/<sup>⊕</sup>L/

DOMINANT » DEFAULT

Dominant triggers have a special cophology which ranks a constraint enforcing dominance higher than default constraints, in the VI above abbreviated as DOMINANT. In this framework, dominance involves a special type of faithfulness, namely correspondence with an abstract induced basemap consisting of only unvalued TBUs. The Kalabari case in (1) involves an input-output basemap  $//^{\text{①}} + \tau\tau// \rightarrow \backslash\tau\tau\backslash$ . It is to this output that the matrix output must match in tonal shape, resulting in the surface form  $\backslash wá rí \backslash$ . This results in the underlying tone of the target going unrealized, addressing the erasure problem. The central insight here is that dominant GT should be characterized as a special type of paradigm uniformity effect, a hypothesis referred to as dominance as transparadigmatic uniformity. The functional motivation for this uniformity is that it provides a more consistent cue for the grammatical category of the trigger.

Finally, in Kalabari case in (1) why is  $N_2$  affected by the dominant pattern but not  $N_1$  or the plural marker (i.e. the scope problem)? I developed a theory in which syntactic structure is mapped to a hierarchical morpho-phonological tree via an operation at spell-out called hierarchy exchange. Each mother node in the morpho-phonological tree represents a cycle, and consists of the trigger of the grammatical tune (one daughter) and the target (the other daughter). In the example above, the dominant trigger [ASSOCIATIVE] forms a unit with the target  $N_2$  to the exclusion of  $N_1$  and the plural marker. By appealing directly to cyclicity, we account for the dominant GT asymmetry in which dominance must always be inward. This is schematized in the figure below.

(4) Morpho-phonological tree with cophologies applying at each node

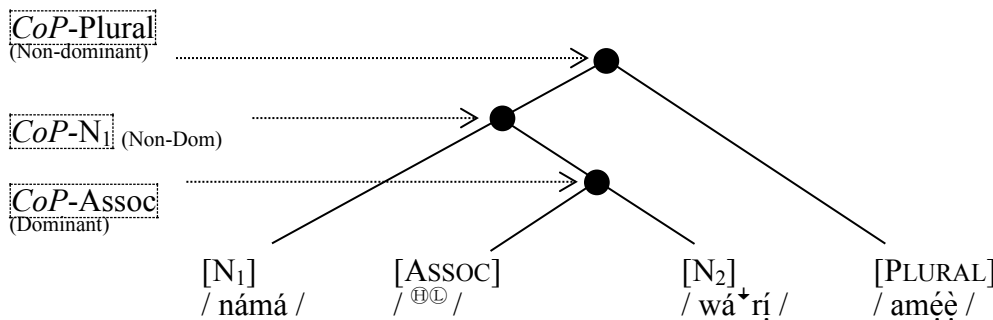

A major component of this model is that hierarchy exchange preserves the inside-out derivational history of the syntactic module by referencing asymmetrical c-command. In this way, I conclude that interface models which appeal to c-command are essentially correct, the most relevant being McPherson (2014) and McPherson & Heath (2016) which derive dominant GT scope via c-command. However, I differ from this direct reference model in that my model refers to c-command only indirectly, mediated by hierarchy exchange. This is thus in line with indirect reference theories of the syntax/phonology interface.

In short, I posit a model which includes (i) floating tone representation, (ii) output-output correspondence (with abstract basemap induction), (iii) spell-out operations which apply in parallel, (iv) cyclicity within the morpho-phonological module, (v) indirect reference to syntactic structure and syntactic relations (e.g. c-command), and (vi) cophologies triggered by DM vocabulary items. By combining disparate models and expanding on others, we arrive at a novel account of grammatical tone with extensive empirical coverage.

## 7.2 Future inquiry

There are several topics which have come up in the course of this study which require future inquiry. I discuss some briefly below.

### **Indomitability.**

In chapter 3, I highlighted several cases of GT indomitability in which a target expected to be subject to a dominant pattern is exceptional and does not undergo the tonal operation. This is a major challenge to any analysis of dominance (including this one). The types of indomitability should be further refined and a more comprehensive analysis sought. This is particularly relevant in debates concerning grammatical tone as cyclic or not, as discussed at the end of chapter 6.

### **Catalyzed dominance.**

In chapter 3 we defined catalyzed dominance (Heath 2016) as the idiosyncratic behavior of a certain morpheme or construction to cause another morpheme in its environment to act as a trigger of a grammatical tone operation (i.e. in context [x-y] y is not a trigger, but in [x-y-z] or [a-y] y is a trigger). How robust is this phenomenon, and how should it be analyzed? Is there anything comparable to this involving segmental operations/allomorphy?

### **Valuation windows.**

A valuation window was defined as the portion of the target-host which is evaluated with respect to whether its TBUs are valued or unvalued. I have largely ignored this issue within part II of this study developing a theory of grammatical tone, and future inquiry on valuation windows is warranted. We saw cases where valuation windows in dominance consist only of a single TBU (as in Japanese) or as a single phonological word (Makonde), both in Chapter 3. I put forward a tentative hypothesis that valuation windows can be localized to phonological constituents at any level on the prosodic hierarchy, but this remains untested.

### **Interaction of GT with other prosody (stress/prosodic hierarchy/intonation/boundary tones).**

We established in this study that the scope of grammatical tone cannot be reduced to other prosodic domains or phenomena. There were several places, however, where we saw them interact, e.g. stress conditioning tone deletion in Shanghai (chapter 6), dominance over a single phonological word in Makonde (chapter 3), among other places. I suspect that one of the most fruitful places for future inquiry will be the interaction of grammatical tone with intonation (intonemes) and/or boundary tones (which are often used to diagnose prosodic constituents). If these are phonologically triggered we should not see the same type of dominance effects as GT, but as it stands there is not enough information to test any predictions of their interactions. It is not clear if boundary tones and intonemes themselves can ever be dominant, and if so, how frequent is this the case and how should it be analyzed?

### **Diachrony.**

The diachronic development of grammatical tone is a rich and essentially unexplored area. If my hypothesis is correct that the tune of dominant GT is floating tone, then we might be able to reconstruct lost segmental exponents. Other diachronic speculation is found in Harry & Hyman (2014), discussing the origin of Kalabari dominant GT as involving an earlier stage of prosodic reduction. And what is the diachronic role for analogy in these effects, as would be predicted under the view of dominance as transparadigmatic uniformity (chapter 5)? How should we approach the diachronic development of these patterns: (i) as tonal competition resulting in deletion of target tones (metaphorically a “push chain”), (ii) as deletion of target tones (e.g. via prosodic reduction) followed by grammatical patterns coming to fill in this vacant position (metaphorically a “pull chain”), or (iii) something else entirely?

### **Functional load of tone.**

Finally, why do some tone languages have extremely robust and intricate grammatical tone systems, whereas other tone languages have virtually none? What are the functional motivations (or historical



accidents) behind having or not having GT? We alluded to this in Chapter 5 in discussing the motivation for dominant and non-dominant GT in terms of uniformity effects, and this line of thinking may prove fruitful. One avenue may be to assess the functional load of tone (both underlying lexical tone and grammatical tone) in individual systems. It is a straightforward and intuitive prediction that those languages with a high lexical role for tone would have less grammatical tone, and vice versa, but this hypothesis is yet to be tested.

**Phases.**

What is the interface between phase theory (Chomsky 2001) and the model proposed here? How should we understand the role of phases in grammatical tone behavior?

## References

- Adger, David. 2003. *Core Syntax: A Minimalist Approach*. Vol. 33. Oxford: University Press Oxford.
- Ahland, Michael. 2012. *A Grammar of Northern Mao (Màwés Aas'è)*. PhD Dissertation, University of Oregon.
- Akinlabi, Akinbiyi, & Liberman, Mark. 2000. The tonal phonology of Yoruba clitics. In Birgit Gerlach & Janet Grijzenhou (eds.), *In Clitics in phonology, morphology and syntax* 36:31-62.
- Akinlabi, Akinbiyi, Bruce Connell, & Ebitare Obikudo. 2009. The Tonal Structure of Nkoroo Nominal Constructions. In *Language Development beyond Borders*, 447–66.
- Alber, Birgit, & Sabine Arndt-Lappe. 2012. Templatic and Subtractive Truncation. In *The Morphology and Phonology of Exponence*, 289–325.
- Albright, Adam C. 2002. The Identification of Bases in Morphological Paradigms. PhD dissertation. University of California, Los Angeles.
- Alderete, John. 2001a. *Morphologically governed accent in Optimality Theory*. Routledge publishing series. New York: Routledge.
- Alderete, John. 2001b. Dominance effects as transderivational anti-faithfulness. *Phonology* 18: 201-253.
- Alderete, John, Jill Beckman, Laura Benua, Amalia Gnanadesikan, John McCarthy & Suzanne Urbanczyk. 1999. Reduplication with fixed segmentism. *Linguistic Inquiry* 30. 327-364.
- Allen, Margaret. 1978. Morphological Investigations. Unpublished Ph. D. Dissertation, University of Connecticut.
- Allott, Anna J. 1967. Grammatical tone in modern spoken Burmese. *Wissenschaftliche Zeitschrift der Karl-Marx-Universität Leipzig: Gesellschafts-und Sprachwissenschaftliche Reihe* 16 (1967): 157-161.
- Andersen, Torben. 1995. Morphological Stratification in Dinka: On the Alternations of Voice Quality, Vowel Length, and Tone in the Morphology of Transitive Verbal Roots in an Monosyllabic Language. *Studies in African Linguistics* 23 (1): 1–64.
- Andersen, Torben. 2004. Jumjum Phonology. *Studies in African Linguistics* 33: 133-162.
- Anderson, Stephen R. 1992. *A-Morphous Morphology*. Vol. 62. Cambridge University Press.
- Anghelescu, Andrei, Joash J. Gambarage, Zoe Wai-Man Lam & Douglas Pulleyblank. 2017. Nominal and verbal tone in Nata: An allomorphy-based account. In Jason Kandybowicz & Harold Torrence, eds., *Africa's Endangered Languages: Documentary and Theoretical Approaches*, 87-123. Oxford: Oxford University Press.
- Anonby, Erik John. 2008. Phonology and Morphology of Mambay (Niger-Congo, Adamawa). PhD dissertation. Leiden University.
- Anttila, Arto. 1997. Deriving variation from grammar. In *Variation, Change and Phonological Theory*, Frans Hinskens, Roeland Van Hout, and W. Leo Wetzels (eds.), 35–68. Amsterdam: John Benjamins.
- Anttila, Arto. 2002. Morphologically conditioned phonological alternations. *Natural Language & Linguistic Theory* 20, 1–42.
- Archangeli, Diana & Douglas Pulleyblank. 2015. Tonal allomorphy in Kinande. In Hsiao, YH and Wee, LH (Eds.), *Capturing Phonological Shades Within and Across Languages*. 76-100. Newcastle upon Tyne, UK: Cambridge Scholars Publishing.
- Arnold, Laura. 2018. Lexical Tone in Metnyo Ambel. *Oceanic Linguistics* 57 (1): 199–220.
- Aronoff, Mark. 1976. *Word Formation in Generative Grammar*. *Linguistic Inquiry* Monographs Cambridge, Mass., no. 1.
- Aronoff, Mark, & Kirsten Fudeman. 2011. *What is morphology?* [second edition] Vol. 8. John Wiley & Sons.
- Arregi, Karlos & Andrew Nevins. 2012. *Morphotactics: Basque auxiliaries and the structure of spellout*. Vol. 86. Springer Science & Business Media.
- Baart, Joan L. G. 1999a. *A sketch of Kalam Kohistani grammar*. Islamabad: National Institute of Pakistan Studies and Summer Institute of Linguistics.
- Baart, Joan L. G. 1999b. Tone rules in Kalam Kohistani (Garwi, Bashkarik). *Bulletin of the School of Oriental and African Studies*. 62:87-104.
- Baart, Joan L. G. 2004. Contrastive Tone in Kalam Kohistani. *Linguistic Discovery* 2.2.
- Bachrach, Asaf, & Andrew Nevins. 2008. *Introduction: Approaching Inflectional Identity*. In Bachrach & Nevins (eds.), *Inflectional identity* (Oxford Studies in Theoretical Linguistics 18). Oxford: Oxford University Press. 1–28.
- Baerman, Matthew, Dunstan Brown, & Greville G. Corbett. 2010. Morphological complexity: a typological perspective. Surrey: University of Surrey. Ms.
- Bakovic, Eric. 2000. Harmony, dominance and control. PhD dissertation. Rutgers University.
- Bat-El, Outi. 1994. Stem Modification and Cluster Transfer in Modern Hebrew. *Natural Language & Linguistic Theory* 12 (4): 571–96.
- Bateman, Janet. 1990a. *Iau Segmental and Tone Phonology*. Nusa, NUSA: Linguistic Studies of Indonesian and Other Languages in Indonesia, 32: 29–42.

- Bateman, Janet. 1990b. Pragmatic Functions of the Tone Morphemes on Illocutionary Force Particles in Iau. In *Miscellaneous Studies of Indonesian and Other Languages in Indonesia*, 32:1–28. NUSA: Linguistic Studies of Indonesian and Other Languages in Indonesia. Jakarta: Universitas Katolik Indonesia Atma Jaya.
- Beckman, Jill. 1998. Positional faithfulness. PhD dissertation, University of Massachusetts, Amherst.
- Bennett, Ryan. 2018. Recursive prosodic words in Kaqchikel (Mayan). *Glossa* 3(1):67. 1-33.
- Bennett, William. 2013. Dissimilation, Consonant Harmony, and Surface Correspondence. PhD dissertation, Rutgers, The State University of New Jersey.
- Benua, Laura. 1997. Transderivational identity: Phonological relations between words. PhD dissertation, University of Massachusetts, Amherst.
- Bermúdez-Otero, Ricardo. 2008. *Stratal Optimality Theory*. Oxford: Oxford University Press.
- Bermúdez-Otero, Ricardo. 2011. Cyclicity. In Marc van Oostendorp, Colin Ewen, Elizabeth Hume & Keren Rice (eds), *The Blackwell companion to phonology*, vol. 4, 2019-2048. Malden, MA: Wiley-Blackwell.
- Bermúdez-Otero, Ricardo. 2012. The Architecture of Grammar and the Division of Labour in Exponence. In *The Morphology and Phonology of Exponence* 41: 8–83.
- Bernstein, Judy B. 1997. Demonstratives and Reinforcers in Romance and Germanic Languages. *Lingua* 102 (2-3): 87–113.
- Bjorkman, Bronwyn M. 2010. Morphology and stress in Nez Perce verbs. *University of British Columbia Working Papers in Linguistics 29: Proceedings of Workshop on the Structure and Constituency of the Languages of the Americas*. Vol. 15. 2010.
- Blackings, Mairi, and Nigel Fabb. 2003. *A Grammar of Ma'di*. Vol. 32. Mouton Grammar Library. Berlin, New York: Berlin: Mouton de Gruyter.
- Blench, Roger M. 2000. Transitions in Izere Nominal Morphology and Implications for the Analysis of Plateau Languages. Nominal Classification in African Languages. *Frankfurter Afrikanische Blätter* 12: 7–28.
- Blevins, Juliette. 1993. A Tonal Analysis of Lithuanian Nominal Accent. *Language* 69, 237-273.
- Bloomfield, L.. 1914. *An Introduction to the Study of Language*. Henry Holt and Company.
- Blumenfeld, Lev. 2006. Constraints on Phonological Interactions. PhD dissertation, Stanford.
- Blumenfeld, Lev. 2015. Meter as Faithfulness. *Natural Language & Linguistic Theory* 33 (1): 79–125.
- Bobaljik, Jonathan. 2000. The ins and outs of contextual allomorphy. In *University of Maryland working papers in linguistics*, ed. Kleantes K. Grohmann and Caro Struijke, volume 10, 35–71. College Park: University of Maryland, Department of Linguistics.
- Bobaljik, Jonathan. 2008. Paradigms (Optimal and otherwise): A case for skepticism. In *Inflectional Identity*, edited by Asaf Bachrach & Andrew Nevins, OUP. 29-54.
- Bobaljik, Jonathan. 2017. Distributed Morphology. *Oxford Research Encyclopedia of Linguistics*.
- Boersma, Paul, and David Weenink. 2007. Praat: Doing Phonetics by Computer (Version 4.5. 26)[Computer Program]. Retrieved May 8, 2007.
- Bonet, Eulàlia. 1994. The Person-Case constraint: A morphological approach. In Heidi Harley and Colin Phillips (eds.), *MIT Working Papers in Linguistics 22: The Morphology-Syntax Connection*. Cambridge, MA: MITWPL, pp. 33-52.
- Booij, Geert. 2005. *The grammar of words. An introduction to linguistic morphology*. 1st edition. Oxford: Oxford University Press.
- Booij, Geert. 2010a. *Construction Morphology*. Oxford: Oxford University Press.
- Booij, Geert. 2010b. Construction morphology. *Language and linguistics compass* 4.7: 543-555.
- Bošković, Željko, & Howard Lasnik, eds. 2007. *Minimalist Syntax: The Essential Readings*. Wiley.
- Boyd, Raymond. 1995. *Le système verbal dans les langues ousangiennes*. LINCOM Europa.
- Boyardieu, Pascal. 1995. *Le Yakoma*. LINCOM Europa.
- Braver, Aaron. 2013. Degrees of Incompleteness in Neutralization: Paradigm Uniformity in a Phonetics with Weighted Constraints. PhD dissertation. Rutgers The State University of New Jersey-New Brunswick.
- Broadwell, George Aaron. 1993. Subtractive Morphology in Southern Muskogean. *International Journal of American Linguistics* 59 (4): 416–29.
- Broadwell, George Aaron, John Foreman & Lee Bickmore. 2011. Floating H Tones and the Tonology of Macuiltianguis Zapotec. *SSILA* 2008.
- Brody, Michael. 2000a. Mirror Theory: Syntactic Representation in Perfect Syntax. *Linguistic Inquiry* 31 (1): 29–56.
- Brody, Michael. 2000b. Word Order, Restructuring and Mirror Theory. In *The Derivation of VO and OV*, 27–44. Peter Svenonius (Ed.). John Benjamins.
- Brown, Jason. 2017. Non-adjacent reduplication requires spellout in parallel. *Natural Language & Linguistic Theory*, 35 (4), 955-977
- Bruening, Benjamin. 2014. Precede-and-Command Revisited. *Language* 90 (2): 342–88.

- Brunelle, Marc. 2009. Northern and Southern Vietnamese Tone Coarticulation: A Comparative Case Study. *Journal of Southeast Asian Linguistics* 1 (1): 49–62.
- Burzio, Luigi. 1998. Multiple Correspondence. *Lingua* 104 (1): 79–109.
- Burzio, Luigi. 2005. Sources of paradigm uniformity. In Laura Downing, T.A. Hall, & Renate Raffelsiefen (eds.), *Paradigms in phonological theory*. Oxford: OUP. 65-106.
- Bybee, Joan L., William Pagliuca, and Revere D. Perkins. 1990. On the asymmetries in the affixation of grammatical material. Studies in typology and diachrony: *Papers presented to Joseph H. Greenberg on his 75th birthday*. Amsterdam: John Benjamins, 1990.
- Bye, Patrik, and Peter Svenonius. 2012. Nonconcatenative Morphology as Epiphenomenon. In *The Morphology and Phonology of Exponence: The State of the Art*, Ed. Jochen Trommer, 427–495. Oxford: Oxford University Press.
- Caballero, Gabriela. 2018. Construction-based inflectional tone patterns in Choguita Rarámuri. *Proceedings from the 6th Tonal Aspects of Language conference*, Berlin, Germany. Available online at: [http://public.beuth-hochschule.de/~mixdorff/tal2018/180618\\_oral\\_session\\_3/TAL\\_2018\\_paper\\_60.pdf](http://public.beuth-hochschule.de/~mixdorff/tal2018/180618_oral_session_3/TAL_2018_paper_60.pdf)
- Caballero, Gabriela, & Alice C. Harris. 2012. A Working Typology of Multiple Exponence. In Ferenc Kiefer, Mária Ladányi, Péter Siptár (eds.), *Current Issues in Morphological theory:(lr) Regularity, Analogy, and Frequency*, 163–88. John Benjamins Publishing.
- Caballero, Gabriela, & Sharon Inkelas. 2013. Word Construction: Tracing an Optimal Path through the Lexicon. *Morphology* 23 (2): 103–43.
- Cahill, Michael. 2000/2001. Noun Classes and Phonology in Kɔnni. *Journal of West African Languages* 18 (1): 49–69.
- Cahill, Michael. 2011. Tonal Diversity in Languages of Papua New Guinea. *SIL Electronic Working Papers 2011-008*.
- Campbell, Eric. W. 2014. Aspects of the phonology and morphology of Zenzontepec Chatino, a Zapotecan language of Oaxaca, Mexico. PhD dissertation. University of Texas, Austin.
- Carleton, Troi, & Scott Myers. 1996. Tonal transfer in Chichewa. *Phonology* 13, 39-72.
- Carlson, Robert. 1994. *A Grammar of Supyire*. (Mouton Grammar Library, 14.) Berlin, New York: Berlin: Mouton de Gruyter.
- Caron, Bernard. 2005. *Za:r (Dictionary, Grammar, Texts)*. Ibadan: IFRA.
- Carstairs, Andrew. 1987. *Allomorphy in Inflexion*. Croom Helm, London
- Carstairs-McCarthy, Andrew. 2001. Grammatically Conditioned Allomorphy, Paradigmatic Structure, and the Ancestry Constraint. *Transactions of the Philological Society* 99 (2): 223–45.
- Carstens, Vicki. 1991. The morphology and syntax of determiner phrases in Kiswahili. PhD Dissertation. UCLA.
- Carstens, Vicki. 2002. Antisymmetry and word order in serial constructions. *Language* 78: 3-50.
- Casali, Roderic F. 2003. [ATR] value asymmetries and underlying vowel inventory structure in Niger-Congo and Nilo-Saharan. *Linguistic Typology* 7. 307-382.
- Casali, Roderic F. 2008. ATR harmony in African languages. *Language and Linguistics Compass* 2. 496-549.
- Casali, Roderic F. 2016. Some inventory-related asymmetries in the patterning of tongue root harmony. *Studies in African Linguistics Volume 45, Numbers 1&2*. 95-140.
- Chang, Mei-Chih Laura. 1992. A Prosodic Account of Tone, Stress, and Tone Sandhi in Chinese Languages. PhD dissertation. University of Hawaii.
- Chang, Y.-C., & Hsieh, F.-F. 2012. Tonal coarticulation in Malaysian Hokkien: A typological anomaly?. *The Linguistics Review*, 29, 37–73.
- Chen, Matthew. 1987. The syntax of Xiamen tone sandhi. *Phonology Yearbook* 4: 109–149.
- Chen, Matthew. 2000. *Tone Sandhi: Patterns across Chinese Dialects*. Vol. 92. Cambridge University Press.
- Childs, G. Tucker. 1995. *A grammar of Kisi: a southern Atlantic language*. Vol. 16. Walter de Gruyter.
- Chomsky, Noam. 1981. *Government and Binding*. Foris, Dordrecht.
- Chomsky, Noam. 1986. *Barriers*. Vol. 13. MIT press.
- Chomsky, Noam. 1994. *Bare phrase structure*. (MIT Occasional Papers in Linguistics 5.) MITWPL, Department of Linguistics and Philosophy, MIT, Cambridge, Mass.
- Chomsky, Noam. 1995. *The Minimalist Program* (current Studies in Linguistics 28). Cambridge et Al.
- Chomsky, Noam. 2001. Derivation by phase. In Ken Hale: A life in language, ed. Michael Kenstowicz, 1–52. Cambridge: MIT Press.
- Chomsky, Noam. 2008. On Phases. *Current Studies in Linguistics Series* 45: 133.
- Chomsky, Noam. 2012. *Phases: Developing the framework*. Vol. 109. Walter de Gruyter, 2012.
- Chomsky, Noam, Morris Halle, & Fred Lukoff. 1956. On Accent and Juncture in English. In *For Roman Jakobson*, 65–80. The Hague.

- Chudak, Magdalena. 2010. Recent English Loanwords In Irish And The Interchange Of Initial Segments. *Bucharest working papers in linguistics*, xii:2.
- Cinque, Guglielmo. 2010. *The Syntax of Adjectives: A Comparative Study*. Vol. 57. MIT press.
- Clem, Emily. 2014. The interaction of lexical and grammatical tone in the Bulu verb system. Undergraduate honors thesis. The Ohio State University.
- Clemens, Lauren Eby. 2014. Prosodic Noun Incorporation and Verb-Initial Syntax. PhD Dissertation. Harvard.
- Clements, George N., & John Goldsmith. 1984. *Autosegmental Studies in Bantu Tone*. Vol. 3. Walter de Gruyter.
- Cohen, Kevin Bretonnel. 2000. *Aspects of the Grammar of Kuku*. Vol. 25. Lincom Europa.
- Cohn, Abigail C. 1989. Stress in Indonesian and Bracketing Paradoxes. *Natural Language & Linguistic Theory* 7 (2): 167–216.
- Cole, J. 1995. The cycle in phonological grammar. In J. Goldsmith (ed.), *Handbook of Phonological Theory*, pp. 70–113. Cambridge, MA: Basil Blackwell.
- Collins, Chris. 1997. Argument Sharing in Serial Verb Constructions. *Linguistic Inquiry*, 461–497.
- Cowell, Andrew, & Alonzo Moss Sr. 2008. *The Arapaho Language*. Boulder: University Press of Colorado.
- Crane, Thera Marie, Larry Hyman & Simon Nsielanga Tukumu. 2011. *A Grammar of Nzadi [B865]: A Bantu Language of Democratic Republic of Congo*. University of California Press.
- Creissels, Denis. 2007. Construct forms in African languages. In Austin et al. [Eds.], *Proceedings of the conference on Language Documentation and Linguistic Theory 2*, SOAS, 2007.
- Creissels, Denis., A. Chebane, & H. Nkhwa. 1997. *Tonal Morphology of the Setswana Verb*. Lincom. Europe: Munich.
- Cruz, Emiliana. 2011. Phonology, tone and the functions of tone in San Juan Quiahije Chatino. PhD dissertation. University of Texas at Austin.
- Czaykowska-Higgins, Ewa. 1993. Cyclicity and Stress in Moses-Columbia Salish (Nxa'amxcin). *Natural Language & Linguistic Theory* 11 (2): 197–278.
- Davis, Stuart. 2005. Capitalistic v. militaristic: The paradigm uniformity effect reconsidered. In Laura J. Downing, T. A. Hall & Renate Raffelsiefen (eds.) *Paradigms in phonological theory*, 107–121. Oxford: Oxford University Press.
- Dawson, Virginia. 2017. Optimal clitic placement in Tiwa. In *Proceedings of the Forty-Seventh Annual Meeting of the North East Linguistic Society*, Vol. 1, ed. Andrew Lamont and Katerina A. Tetzloff, 243-256. Amherst: GLSA.
- Deal, Amy Rose, and Matthew Wolf. 2016. Outwards-sensitive phonologically conditioned allomorphy in Nez Perce. In Vera Gribanova and Stephanie Shih (eds.), *The Morphosyntax-Phonology Connection*, pp. 29-60. Oxford: Oxford University Press.
- Don, Jan, and Elma Blom. 2006. A constraint-based approach to morphological neutralization. *Linguistics in the Netherlands* 23.1: 78-88.
- Donahue, P. L. 1997. Tone in New Guinea. *Linguistic Typology* 1(3). 347–386.
- Downing, Laura. 1996. *The Tonal Phonology of Jita*. Vol. 5 of Lincom Studies in African Linguistics. Munich: Lincom Europa.
- Downing, Laura. 2014. Melodic Verb Tone Patterns in Jita. *Africana Linguistica* 20: 101–19.
- Downing, Laura, T. Alan Hall, & Renate Raffelsiefen. 2005. *Paradigms in Phonological Theory*. Oxford University Press.
- Duanmu, San. 1992. An Autosegmental Analysis of Tone in Four Tibetan Languages. *Linguistics of the Tibeto-Burman Area* 15:1
- Duanmu, San. 1997. Recursive Constraint Evaluation in Optimality Theory: Evidence from Cyclic Compounds in Shanghai. *Natural Language & Linguistic Theory* 15 (3): 465–507.
- Efere, Emmanuel Efereala. 2001. The pitch system of the Bumo dialect of Izon. In Suzanne Gessner, Sunyoung Oh & Kayono Shiobara (eds), *Current research on African languages and linguistics*, 115-259. University of British Columbia Working Papers in Linguistics 4.
- Elfner, Emily. 2012. Syntax-Prosody Interactions in Irish. PhD dissertation. University of Massachusetts, Amherst.
- Elugbe, Ben O. 1989. *Comparative Edoid: Phonology and Lexicon*. University of Port Harcourt Press.
- Embick, David. 2010. *Localism versus Globalism in Morphology and Phonology*. Vol. 60. MIT Press.
- Embick, David. 2015. *The Morpheme: A Theoretical Introduction*. Vol. 31. Walter de Gruyter GmbH & Co KG.
- Embick, David, & Rolf Noyer. 1999. Locality in Post-Syntactic Operations. *MIT Working Papers in Linguistics* 34:265-317.
- Embick, David, & Rolf Noyer. 2001. Movement operations after syntax. *Linguistic Inquiry*, 32(4). 555–595.
- Epps, Patience. 2008. *A Grammar of Hup*. Vol. 43. Walter de Gruyter.
- Epstein, Samuel D. 1999. Un-principled syntax: the derivation of syntactic relations. In Samuel D. Epstein and Norbert Hornstein, eds., *Working minimalism*, 317-345. Cambridge: MIT Press.

- Epstein, Samuel D., & Norbert Hornstein. 1999. *Working Minimalism*. MIT Press.
- Fedden, Sebastian. 2012. Tone in Mian and other Mountain Ok languages. Paper presented at the *Workshop on the Languages of Melanesia 2012*, Kioloa, Australia.
- Fitzgerald, Colleen, & Amy Fountain. 1995. The Optimal Account of Tohono O'odham Truncation. Paper presented at the Annual Meeting of the Linguistic Society of America, New Orleans.
- Fodor, Jerry. 1983. *The modularity of the mind*. Cambridge, Mass.: MIT-Bradford
- Foley, Steven. to appear. Morphological conspiracies in Georgian and Optimal Vocabulary Insertion. In the *Proceedings of the 52nd Chicago Linguistics Society*, eds. Jessica Kantarovich, Tran Truong, & Orest Xherija.
- Freidin, Robert, & Howard Lasnik. 2011. Some Roots of Minimalism in Generative Grammar. In *The Oxford Handbook of Linguistic Minimalism*. Edited by Cedric Boeckx.
- Gandour, J., Potisuk, S., & Dechongkit, S. 1994. Tonal coarticulation in Thai. *Journal of Phonetics*, 22, 474–492.
- Gibbon, Dafydd. 1998. Intonation in German. In Daniel Hirst & Albert Di Cristo (Eds.), *Intonation systems: A survey of twenty language*. Cambridge University Press.
- Gilley, Leoma G. 1992. *An Autosegmental Approach to Shilluk Phonology*. Vol. 103. Summer Institute of Linguistics and the University of Texas at Arlington Publications in Linguistics.
- Gimba, Alhaji Maina. 1998. Low tone raising in Bole. MA thesis, UCLA.
- Giusti, Giuliana. 1995. Heads and modifiers among determiners: Evidence from Rumanian. *Advances in Roumanian linguistics*, ed. by G. Cinque and G. Giusti. 103-25. Philadelphia: John Benjamins.
- Gleim, Daniel Christoph. 2018. Duke-of-York epenthesis in Arapaho. Handout for 2018 *Old World Conference on Phonology* 12–14 January 2018 London, United Kingdom
- Goldsmith, John. 1976. *Autosegmental phonology*. Vol. 159. Indiana University Linguistics Club Bloomington.
- Goldsmith, John. 1980. *Autosegmental phonology*. New York: Garland Publishing.
- Goldsmith, John. 1987. Stem tone patterns of the Lacustrine Bantu languages. In D. Odden (ed.) *Current approaches to African linguistics* vol 4. Dordrecht: Foris. 167-178.
- Goldsmith, John. 2002. Tone in Mituku: How a Floating Tone Nailed down an Intermediate Level. In Jacques Durand, Bernard Laks (eds.), *Phonetics, Phonology, and Cognition*, 80–95. Oxford University Press.
- Golston, Chris. 1990. Floating H (and L\*) tones in Ancient Greek. In *Arizona phonology conference III*, eds. James Myers and Patricia E. Pérez, 66–82. Tucson: University of Arizona Linguistics Department.
- Gomez, E. & Michael Kenstowicz. 2000. Barasana tone and accent. *IJAL* 66, 419–463.
- Gouskova, Maria, & Tal Linzen. 2015. Morphological conditioning of phonological regularization. *The Linguistic Review* 32(3):427-473.
- Green, Antony D. 2006. The independence of phonology and morphology: the Celtic mutations. *Lingua* 116:1946–1985.
- Green, Christopher R. 2018. A survey of word-level replacive tonal patterns in Western Mande. *Mandenkan* 59.67-108.
- Green, Christopher R., & Abbie E. Hantgan-Sonko. 2018. Word-level ATR asymmetry: Insights from Bondu-so vowel harmony. Handout for *GLOW 41*, Budapest, April 2018.
- Greenberg, Joseph Harold. 1963. *The Languages of Africa*. Vol. 25. Indiana University.
- Guekguezian, Peter Ara. 2017. Templates as the interaction of recursive word structure and prosodic well-formedness. *Phonology* 34.1 (2017): 81-120.
- Gussenhoven, Carlos. 1983. Focus, mode and the nucleus. *Journal of Linguistics* 19. 377–417.
- Gussenhoven, Carlos. 1992. Sentence accents and argument structure. In Iggy Roca (ed.) *Thematic structure: its role in grammar*. Berlin & New York: Foris. 79–106.
- Gussenhoven, Carlos. 2001. Suprasegmentals. In: N. J. Smelser and Paul B. Baltes (Eds.) *International Encyclopedia of the Social and the Behavioural Sciences*. Oxford: Pergamon. 15294-15298.
- Gussenhoven, Carlos. 2004. *The phonology of tone and intonation*. Cambridge: Cambridge University Press.
- Gussenhoven, Carlos. 2006. Between Stress and Tone in Nubi Word Prosody. *Phonology* 23 (2): 192–223.
- Hainsworth, Joan. 1969. Narak word tone. SIL Papua New Guinea (Ukarumpa). Unpublished manuscript.
- Hale, Ken, & Samuel Jay Keyser. 1998. The Basic Elements of Argument Structure. *MIT Working Papers in Linguistics* 32: 73–118.
- Hall, Kathleen Currie, Elizabeth Hume, Florian T. Jaeger, & Andrew Wedel. 2016. The Message Shapes Phonology. Manuscript. University of British Columbia, University of Canterbury, University of Rochester & Arizona University.
- Hall, T.A. & John Scott. 2007. Inflectional paradigms have a base: Evidence from s-dissimilation in Southern German dialects. *Morphology* 17(1):151-178.
- Halle, Morris. 1973. Prolegomena to a Theory of Word Formation. *Linguistic Inquiry* 4 (1): 3–16.
- Halle, Morris & Alec Marantz. 1993. Distributed Morphology and the Pieces of Inflection. In *The View from Building 20*, ed. Kenneth Hale and S. Jay Keyser. MIT Press, Cambridge, 111-176.

- Halle, Morris, & Karuvannur P. Mohanan. 1985. Segmental Phonology of Modern English. *Linguistic Inquiry* 16 (1): 57–116.
- Halle, Morris, & Jean-Roger Vergnaud. 1981. Harmony Processes. In W. Klein and W. Levett (eds.), *Crossing the Boundaries in Linguistics*. Dordrecht: Reidel, 1-22.
- Halle, Morris, & Jean-Roger Vergnaud. 1987a. *An Essay on Stress*. MIT press.
- Halle, Morris, & Jean-Roger Vergnaud. 1987b. Stress and the Cycle. *Linguistic Inquiry* 18 (1): 45–84.
- Halle, Morris, James W. Harris, and Jean-Roger Vergnaud. 1991. A Reexamination of the Stress Erasure Convention and Spanish Stress. *Linguistic Inquiry* 22 (1): 141–59.
- Hammarström, Harald. 2014. The Status of Description of the World's Languages. Unpublished Powerpoint Presentation. 27 May 2014, Nijmegen.
- Han, M.S., & Kim, K.-O. 1974 .Phonetic variation of Vietnamese tones in disyllabic utterances. *Journal of Phonetics*, 2, 223–232.
- Hansson, Gunnar Ólafur. 2014. (Dis)Agreement by (Non)Correspondence. In *UC Berkeley Phonology Lab Annual Report: ABC↔Conference*, 3-62.
- Hargus, Sharon, & Beavert, V. 2006. High-ranking affix faithfulness in Yakima Sahaptin. In *Proceedings of the 25th West Coast Conference on Formal Linguistics*. 177-185.
- Harizanov, Boris, & Vera Gribova. 2018. Whither Head Movement? *Natural Language & Linguistic Theory*. 1–62.
- Harley, Heidi. 2014. On the identity of roots. *Theoretical Linguistics* 40(3/4): 225 – 276
- Harley, Heidi & Rolf Noyer. 1999. Distributed Morphology. State-of-the-Article. *GLOT International* 4(4). 3-9.
- Harris, Alice. 2017. *Multiple Exponence*. Oxford: OUP.
- Harry, Otelemate. 2004. *Aspects of the Tonal System of Kalabari-Ijo*. Stanford, CSLI Publications.
- Harry, Otelemate, & Larry M. Hyman. 2014. Phrasal Construction Tonology: The Case of Kalabari. *Studies in Language* 38(4):649–689.
- Haspelmath, Martin & Andrea Sims. 2010. *Understanding Morphology*. Routledge.
- Haugen, Jason. 2008. *Morphology at the interfaces: reduplication and noun incorporation in Uto-Aztecan*. John Benjamins Publishing Company (Linguistik Aktuell/Linguistics Today 117), Amsterdam/Philadelphia.
- Haugen, Jason. 2011. Reduplication in distributed morphology. In *Coyote papers: Working papers in linguistics*, Vol. 18, eds. Jessamyn Schertz, Alan Hogue, Dane Bell, Dan Brenner, and Samantha Wray, 1–27. Tucson: University of Arizona Linguistics Circle.
- Hayes, Bruce. 1999. Phonological Restructuring in Yidij and its Theoretical Consequences. In Ben Hermans and Marc van Oostendorp (eds.), *The Derivational Residue in Phonological Optimality Theory*. Amsterdam: John Benjamins. 175-205.
- Hayes, Bruce, Bruce Tesar, & Kie Zuraw. 2003. OTSoft 2.1, Software Package.
- Heath, Jeffrey. 2008. *A Grammar of Jamsay*. Berlin: Mouton De Gruyter.
- Heath, Jeffrey. 2016. *A Grammar of Donno So or Kamma So*. Language Description Heritage Library (online).
- Heath, Jeffrey. 2017. A Grammar of Jalkunan (Mande, Burkina Faso). Unpublished manuscript.
- Heath, Jeffrey, & Laura McPherson. 2013. Tonosyntax and reference restriction in Dogon NPs. *Language* 89: 265–296.
- Hippisley, Andrew & Gregory Stump. 2017. *The Cambridge Handbook of Morphology*. Cambridge: CUP.
- Hockett, Charles F. 1954. Two Models of Grammatical Description. *Word* 10 (2-3): 210–34.
- Hollenbach, B. 2003. The historical source of an irregular Mixtec tone-sandhi pattern. In M. R. Wise, T. Headland, & R. Brend (Eds.), *Language and life: essays in memory of Kenneth L. Pike* (pp. 535– 552). Dallas: SIL International.
- Hollenbach, Elena Erickson de. 2005 [2004-05]. Los tonos del mixteco de Magdalena Peñasco. [https://www.sil.org/system/files/reapdata/41/47/73/41477327793356175966682484495754425683/G030\\_TonosMixtecoMP\\_xtm.pdf](https://www.sil.org/system/files/reapdata/41/47/73/41477327793356175966682484495754425683/G030_TonosMixtecoMP_xtm.pdf)
- Holmberg, Anders, & David Odden. 2008. The Noun Phrase in Hawrami. *Aspects of Iranian Linguistics*, 129–52.
- Hsu, Brian, & Karen Jesney. 2016. Scalar positional markedness and faithfulness in Harmonic Grammar. *Proceedings of the Annual Meeting of the Chicago Linguistic Society*. Vol. 51. 2016.
- Hsu, Brian, & Karen Jesney. 2017. Loanword Adaptation in Québec French: Evidence for Weighted Scalar Constraints. *Proceedings of the 34th West Coast Conference on Formal Linguistics*. 2017.
- Hulst, Harry van der. 2010. Word accent: terms, typologies and theories. In Harry van der Hulst, Rob Goedemans and Ellen van Zanten (eds.), *A Survey of Word Accentual Patterns in the Languages of the World*. Berlin: Mouton de Gruyter, 3-54.
- Hulst, Harry van der. 2012. Deconstructing Stress. *Lingua* 122 (13): 1494–1521.
- Hulst, Harry van der, & J. van der Weijer. 1995. Vowel Harmony. In J. Goldsmith (ed.), *The Handbook of Phonological Theory*. Cambridge, MA: Blackwell Publishers, 495-534.

- Hyman, Larry M. 1981a. *Noni Grammatical Structure: With Special Reference to Verb Morphology*. (Southern California Occasional Papers in Linguistics 9.) Los Angeles: Department of Linguistics, University of Southern California.
- Hyman, Larry M. 1981b. Tonal Accent in Somali. *Studies in African Linguistics* 12 (2): 169–203.
- Hyman, Larry M. 2001. Tone systems. In Martin Haspelmath et al (eds), *Language typology and language universals: An international Handbook*, vol. 2, 1367-1380. Berlin & New York: Walter de Gruyter.
- Hyman, Larry M. 2006. Word-prosodic typology. *Phonology*. 23.225-257.
- Hyman, Larry M. 2007. Universals of Tone Rules: 30 Years Later. In Tomas Riad & Carlos Gussenhoven (eds.), *Tones and Tunes: Studies in Word and Sentence Prosody*, 1–34. De Gruyter Mouton.
- Hyman, Larry M. 2009. How (not) to do phonological typology: the case of pitch-accent. *Language Sciences* 31 (2009) 213–238.
- Hyman, Larry M. 2011. Tone: is it different? In: John Goldsmith; Jason Riggle & Alan C. Yu (eds.), *The Handbook of Phonological Theory*, 197–239. Chichester: Wiley-Blackwell.
- Hyman, Larry M. 2012. Issues in the Phonology-Morphology Interface in African Languages. *UC Berkeley Phonology Lab Annual Reports* 8 (8).
- Hyman, Larry M. 2016. Morphological Tonal Assignments in Conflict: Who Wins. In Palancar & Leonard (eds). *Tone and Inflection: New Facts and Perspectives*, 15–39. Series:Trends in Linguistics. Studies and Monographs [TiLSM] 296. De Gruyter Mouton
- Hyman, Larry M. 2017. Disentangling Conjoint, Disjoint, Metatony, Tone Cases, Augments, Prosody and Focus in Bantu. In Jenneke van der Wal & Larry Hyman (eds.), *The Conjoint/Disjoint Alternation in Bantu*. Series: Trends in Linguistics. Studies and Monographs [TiLSM] 301. De Gruyter Mouton.
- Hyman, Larry M. 2018a. Towards a Typology of Postlexical Tonal Neutralizations. In Haruo Kubozono & Mikio Giriko (eds.), *Tonal Change and Neutralization*. 27:7. Series:Phonology and Phonetics [PP]. De Gruyter Mouton.
- Hyman, Larry M. 2018b. Towards a Typology of Tone System Changes. In Haruo Kubozono & Mikio Giriko (eds.), *Tonal Change and Neutralization*. 27:7. Series:Phonology and Phonetics [PP]. De Gruyter Mouton.
- Hyman, Larry M., & Ernest Rugwa Byarushengo. 1984. A Model of Haya Tonology. In George N. Clements & John Goldsmith (eds.), *Autosegmental Studies in Bantu Tone* 53. Series: Publications in African Languages and Linguistics Band 3. De Gruyter.
- Hyman, Larry M., & Bernard Comrie. 1981. Logophoric Reference in Gokana. *Journal of African Languages and Linguistics* 3 (1): 19–38.
- Hyman, Larry M., & Francis X. Katamba. 1993. A New Approach to Tone in Luganda. *Language*, 34–67.
- Hyman, Larry M., & Knut J. Olawsky. 2004. Dagbani verb tonology. In *Trends in African Linguistics* 4, 97-108. Africa World Press, Inc.
- Hyman, Larry M., Hannah Sande, Florian Lionnet, Nicholas Rolle, & Emily Clem. in press. Prosodic systems : Niger-Congo and Adjacent Areas. In *Oxford handbook of language prosody*. ed. Carlos Gussenhoven and Aoju Chen.
- Hyman, Larry M., & Russell G. Schuh. 1974. Universals of Tone Rules: Evidence from West Africa. *Linguistic Inquiry* 5 (1): 81–115.
- Hyman, Larry M., & Maurice Tadadjeu. 1976. Floating Tones in Mbam-Nkam. *Studies in Bantu Tonology* 3: 59–1.
- Ikoru, Suanu. 1996. *The Kana Language*. No. 40. Research School CNWS, 1996.
- Inkelas, Sharon. 1998. The Theoretical Status of Morphologically Conditioned Phonology: A Case Study of Dominance Effects. *Yearbook of Morphology 1997*. Ed. Geert Booij and Jaap Van Marle. Springer Netherlands, 121–155.
- Inkelas, Sharon. 2009. Another Look at Velar Deletion in Turkish, with Special Attention to the Derived Environment Condition. *UC Berkeley Phonology Lab Annual Reports*, 5.
- Inkelas, Sharon. 2014. *The Interplay of Morphology and Phonology*. Oxford: Oxford University Press.
- Inkelas, Sharon, & Gabriela Caballero. 2013. Word Construction: Tracing an Optimal Path through the Lexicon. In *New Tools in the Modelling of Morphological Exponence* 23: 103–43.
- Inkelas, Sharon, & Cheryl Zoll. 2005. *Reduplication: Doubling in morphology*. Cambridge: Cambridge University Press.
- Inkelas, Sharon, & Cheryl Zoll. 2007. Is Grammar Dependence Real? A Comparison between Cophonological and Indexed Constraint Approaches to Morphologically Conditioned Phonology. *Linguistics*, 45(1):133–171.
- Itô, Junko. 1990. Prosodic Minimality in Japanese. In Michael Ziolkowski, Manual Noske, and Karen Deaton (eds.) *Proceedings of Chicago Linguistic Society 26: Parasession on the Syllable in Phonetics and Phonology*, pp. 213–239. Chicago Linguistic Society, Chicago.



- Itô, Junko & Armin Mester. 1995. The core-periphery structure of the lexicon and constraints on reranking. In Jill Beckman, Sue Urbanczyk & Laura Walsh Dickey (eds.), *Papers in Optimality Theory*, 181-209. Amherst, MA: GLSA.
- James, Dorothy J. 1994. Word tone in a Papuan language: An autosegmental solution. In *Language and Linguistics in Melanesia*. 25.125-148.
- Jamieson, Carole Ann. 1982. Conflated Subsystems Marking Person and Aspect in Chiquihuitlán Mazatec Verbs. *International Journal of American Linguistics* 48 (2): 139-67.
- Jardine, Adam. 2016. Computationally, tone is different. *Phonology* 33.2: 247-283.
- Jenewari, Charles J. 1977. Kalabari syntax. Ibadan. PhD dissertation. University of Ibadan.
- Jurafsky, Daniel & James H. Martin . 2017. Speech and Language Processing. Ed 3. Draft of August 28, 2017. <https://web.stanford.edu/~jurafsky/slp3/ed3book.pdf>
- Kager, René. 1999. *Optimality Theory*. Cambridge: Cambridge University Press.
- Kager, René. 2000. Stem Stress and Peak Correspondence in Dutch. In *Optimality Theory: Phonology, Syntax, and Acquisition*, 121-50.
- Kaisse, Ellen. 1985. *Connected speech: The interaction of syntax and phonology*, Academic Press, Orlando.
- Kalinowski, Cristin. 2015. A Typology of Morphosyntactic Encoding of Focus in African Languages. PhD dissertation. State University of New York at Buffalo.
- Kam, Tak Him. 1980. Semantic-tonal processes in Cantonese, Taishanese, Bobai, and Siamese. *Journal of Chinese Linguistics Berkeley, Cal.* 8.2:205-238.
- Kandybowicz, Jason & Harold Torrence. 2016. Predicate Focus in Krachi: 2 Probes, 1 Goal, 3 PFs. In *Proceedings of the 33rd West Coast Conference on Formal Linguistics*, ed. Kyeong-min Kim et al., 227-236. Somerville, MA: Cascadilla Proceedings Project.
- Kastner, Itamar. 2018. Templatic morphology as an emergent property: Roots and functional heads in Hebrew. *NLLT*.
- Kawahara, Shigeto. 2002. Faithfulness among variants. *Phonological Studies*, 5, 47-54.
- Kawahara, Shigeto. 2015. The phonology of Japanese accent. In Haruo Kubozono (ed.) *The Handbook of Japanese Language and Linguistics: Phonetics and Phonology*. Mouton. pp.445-492.
- Kayne, Richard S. 1994. *The Antisymmetry of Syntax*. MIT Press.
- Kean, Mary-Louise. 1974. The strict cycle in phonology. *Linguistic Inquiry* 5:179-203.
- Keine, Stefan & Gereon Müller. 2015. Differential argument encoding by impoverishment. *Scales and hierarchies: A cross-disciplinary perspective*. 75-130.
- Kenstowicz, Michael. 1996. Uniform exponence and base identity. In J. Durand & B. Laks (eds.), *Current trends in phonology*. University of Salford Press. 363-393.
- Khoali, Benjamin Thakampholo. 1991. A Sesotho tonal grammar. PhD dissertation. University of Illinois at Urbana-Champaign.
- Kim, Yuni. 2003. Vowel elision and the morphophonology of dominance in Aymara. Unpublished MS.
- Kimenyi, Alexandre. 2002. *A tonal grammar of Kinyarwanda: an autosegmental and metrical analysis*. Vol. 9. Edwin Mellen Press.
- Kiparsky, Paul. 1982. Lexical morphology and phonology. In Yang, I.-S. (ed.) *Linguistics in the morning calm*. Seoul: Hanshin. 3-91.
- Kiparsky, Paul. 1984. A Compositional Approach to Vedic Word Accent. In S.D. Joshi (ed.), *Amrtadhara: Prof R. N. Dandeka Felicitation Volume*. Ajanta Publications, Jawahar Nagar Delhi.
- Kiparsky, Paul. 2000. Opacity and Cyclicity. *The Linguistic Review* 17 (2-4): 351-366.
- Kiparsky, Paul. 2015. Stratal OT: A synopsis and FAQs. In Yuchau E. Hsiao & Lian-hee Wee (eds.), *Capturing Phonological Shades*. Cambridge/New York: Cambridge University Press. 2-44.
- Kiparsky, Paul, & Morris Halle. 1977. Towards a Reconstruction of the Indo-European Accent. In Larry Hyman (ed.), *Studies in Stress and Accent*, 209-238. Los Angeles: University of Southern California Press.
- Kisseberth, Charles W., & Mohammad Imam Abasheikh. 2011. Chimwiini phonological phrasing revisited. *Lingua* 121.13 (2011): 1987-2013.
- Klingenheben, A. 1949. Ist das Somali eine Tonsprache? *Zeitschrift für Phonetik. Sprachwissenschaft und Kommunikationsforschung* 3, 289-302.
- Konnerth, Linda. 2014. A grammar of Karbi. PhD dissertation. University of Oregon.
- Korsah, Sampson, & Andrew Murphy. 2017. Tonal Reflexes of A-Movement in Asante Twi. Ms. Universität Leipzig.
- Kraal, Pieter J. 2005. A Grammar of Makonde (Chinnima, Tanzania). PhD dissertation. Leiden University.
- Krämer, Martin. 2006. The Emergence of the Comparatively Unmarked. In D. Baumer Ua (Hg.) *Proceedings of the 25th West Coast Conference on Formal Linguistics*. Somerville: Cascadilla, 236-44.
- Kubozono, Haruo. 2016. Varieties of Pitch Accent Systems in Japanese. *Lingua* 122(13):1395-1414.

- Kubozono, Haruo, & Mikio Giriko (eds.). 2018. *Tonal Change and Neutralization*. Vol. 27. Walter de Gruyter.
- Kurisu, Kazutaka. 2001. The phonology of morpheme realization. PhD dissertation. University of California Santa Cruz.
- Kushnir, Yuriy. 2018. Accent Strength in Lithuanian: Evidence from the Nominal Accentuation System. Ms.
- Ladd, Robert. 2008. *Intonational Phonology*. Cambridge University Press.
- Ladefoged, Peter, & Keith Johnson. 2011. *A course in phonetics*. Boston, MA: Wadsworth.
- Lahne, Antje. 2010. A multiple specifier approach to left-peripheral architecture. *Linguistic Analysis* 35:73-108.
- Laniran, Yetunde O., & George N. Clements. 2003. Downstep and high raising: interacting factors in Yoruba tone production. *Journal of Phonetics* 31.2 (2003): 203-250.
- Larson, Richard. 1988. On the double object construction. *Linguistic Inquiry* 19, 335-391.
- Leben, William. 1978. The Representation of Tone. In Victoria A. Fromkin (ed.), *Tone: A Linguistic Survey*. 177-219. Academic Press, New York, NY.
- Lee, Sang-Oak. 1978. Middle Korean Tonology. PhD Dissertation. University of Illinois.
- Lee, Seunghun J. 2009. The spreading, blocking, and optimization of H tones – Depressor consonants in Dagara. Matthias Brenzinger, Anne-Maria Fehn. (eds.). *Proceedings of the 6th WOCAL World Congress of African Linguistics, Cologne, 17-21 August 2009*. Rüdiger Köppe Verlag.
- Levelt, W. J. M. 1989. *Speaking: From intention to articulation*. Cambridge, MA: MIT Press.
- Lieber, Rochelle. 1992. *Deconstructing Morphology: Word Formation in Syntactic Theory*. University of Chicago Press.
- Lieber, Rochelle. 2009. *Introducing morphology*. Cambridge: CUP.
- Lukas, Johannes. 1969. Tonpermeable und Tonimpermeable Konsonanten im Bolanci (Nordnigerien). In *Ethnological and Linguistic Studies in Honour of N. J. van Warmelo*, pp. 133–138. Pretoria: Government Printer
- Lukas, Johannes & Willms, A. 1961. Outline of the Language of the Jarawa in Northern Nigeria (Plateau Province). *Afrika und Übersee* XLV. 1-66.
- Maddieson, Ian. 2013. Tone. In: Dryer, Matthew S. & Haspelmath, Martin (eds.) *The World Atlas of Language Structures Online*. Leipzig: Max Planck Institute for Evolutionary Anthropology. Available online at <http://wals.info/chapter/13>, Accessed on 2018-04-19.
- Mak, Cornelia. 1950. A unique tone perturbation in Mixteco. *International Journal of American Linguistics*, 16, 82–86.
- Marantz, Alec. 1997. No Escape from Syntax: Don't Try Morphological Analysis in the Privacy of Your Own Lexicon. *University of Pennsylvania Working Papers in Linguistics* 4 (2): 14.
- Marlo, Michael R. 2013. Verb tone in Bantu languages: micro-typological patterns and research methods. *Africana Linguistica* 19. 137-234.
- Marlo, Michael R., Leonard Chacha Mwita & Mary Paster. 2014. Kuria tone melodies. *Africana Linguistica* 20. 277-294.
- Martin, Jack. 1988. Subtractive morphology as dissociation. In Hagit Borer (ed.), *Proceedings of the seventh West Coast Conference on Formal Linguistics*. Stanford, CA: Stanford Linguistics Association
- Marvin, Tatjana. 2008. The interaction between stress, syntax and meaning in Slovenian Priscian formations. In Franc Marušič & Rok Žaucer (eds.), *Studies in formal Slavic linguistics. Contributions from Formal Description of Slavic Languages* 6.5, 191–212. Frankfurt am Main: Peter Lang Verlag.
- Mascaró, Joan. 1976. Catalan phonology and the phonological cycle. PhD dissertation, MIT. Distributed by Indiana University Linguistics Club.
- Mascaró, Joan. 2016. Morphological Exceptions to Vowel Reduction in Central Catalan and the Problem of the Missing Base. *Catalan Journal of Linguistics* 15:27-51.
- Matthews, Peter H. 1972. *Inflectional Morphology: A Theoretical Study Based on Aspects of Latin Verb Conjugation*. Vol. 6. CUP Archive.
- Matthews, Peter H. 1974. *Morphology*. Cambridge: CUP.
- McCarthy, John. 1999. Sympathy and phonological opacity. *Phonology*. 78.
- McCarthy, John. 2008. The serial interaction of stress and syncope. *Natural Language & Linguistic Theory* 26:499–546.
- McCarthy, John, & Joe Pater. 2016. *Harmonic grammar and harmonic serialism*. *Equinox*. 15, 19, 30
- McCarthy, John, & Alan Prince. 1993. Prosodic Morphology I: constraint interaction and satisfaction. Ms, University of Massachusetts, Amherst & Rutgers University.
- McCarthy, John, & Alan Prince. 1994. The emergence of the unmarked: optimality in prosodic morphology. *NELS* 24. 333–379.

- McCarthy, John, & Alan Prince. 1995. Faithfulness and reduplicative identity. *University of Massachusetts Occasional Papers in Linguistics 18: Papers on Optimality Theory*, edited by J. Beckman, L. Walsh Dickey & S. Urbanczyk, 249-384. Graduate Linguistic Student Association, University of Massachusetts, Amherst.
- McIntosh, Justin Daniel. 2015. Aspects of phonology and morphology of Teotepec eastern Chatino. PhD dissertation. University of Texas, Austin.
- McKendry, Inga. 2013. *Tonal Association, Prominence and Prosodic Structure in South-Eastern Nochixtlán Mixtec*. PhD dissertation. University of Edinburgh.
- McPherson, Laura. 2013. *A Grammar of Tommo So*. Berlin, Boston: De Gruyter Mouton.
- McPherson, Laura. 2014. Replacive grammatical tone in the Dogon languages. PhD Dissertation. University of California Los Angeles.
- McPherson, Laura. 2016. Cyclic spell-out and the interaction of Seenku tonal processes. *Tonal Aspects of Languages*. 43-47.
- McPherson, Laura. 2017a. Multiple feature affixation in Seenku plural formation. *Morphology* 27.2: 217-252.
- McPherson, Laura. 2017b. Tone Features Revisited: Evidence from Seenku (Mande, Burkina Faso). *Proceedings of ACAL* 46: 5-21.
- McPherson, Laura. 2017c. Constructions and competitions in Dogon inflectional tonology. Unpublished manuscript.
- McPherson, Laura, & Jeffrey Heath. 2016. Phrasal grammatical tone in the Dogon languages. *Natural Language & Linguistic Theory* 34(2):593-639.
- McWhorter, John. 2016. Is Radical Analyticity Normal? In Elly van Gelderen (ed.) *Cyclical Change Continued*. John Benjamins.
- Melvold, J. 1986. Cyclicity and Russian Stress. In J. McDonough and B. Plunkett (eds.), *Proceedings of the Northeastern Linguistic Society 17*. Amherst, MA: GLSA.
- Merchant, Jason. 2015. How Much Context Is Enough? Two Cases of Span-Conditioned Stem Allomorphy. *Linguistic Inquiry* 46 (2): 273-303.
- Michaud, Alexis. 2017. *Tone in Yongning Na: Lexical Tones and Morphotonology*. Language Science Press.
- Mohanan, K.P. 1982. Lexical Phonology, MS, IULC.
- Mohanan, K.P. 1986. *The theory of lexical phonology*. Dordrecht: Reidel.
- Mortensen, David. 2006. Logical and Substantive Scales in Phonology. PhD dissertation. University of California, Berkeley.
- Moser, Rosmarie. 2007. *Kabba: A Nilo-Saharan Language of the Central African Republic*. Vol. 63. LINCOM Studies in African Linguistics. München: Lincom Europa.
- Moskal, Beata, & Peter W. Smith. 2016. Towards a Theory without Adjacency: Hyper-Contextual VI-Rules. *Morphology* 26 (3-4): 295-312.
- Nespor, Marina, & Irene Vogel. 1986. *Prosodic phonology*. Dordrecht: Foris.
- Newman, John & Robert G. Petterson. 1990. The Tones of Kairi. *Oceanic Linguistics* 29(1). 49-76.
- Newman, Paul. 1986. Tone and Affixation in Hausa. *Studies in African Linguistics* 17, 249-267.
- Newman, Paul. 2007. *A Hausa-English Dictionary*. Yale University Press.
- Newman, Roxana Ma. 1971. Downstep in Ga'anda. *Journal of African Languages* 10(1): 15-27.
- Nichols, Johanna. 1986. Head-Marking and Dependent-Marking Grammar. *Language*, 56-119.
- Nouveau, Dominique. 1994. Language Acquisition, Metrical Theory, and Optimality: A Study of Dutch Word Stress. PhD dissertation. Utrecht University.
- Noyer, Rolf. 1992. Features, Positions and Affixes in Autonomous Morphological Structure. PhD dissertation. MIT.
- Noyer, Rolf. 1994. Mobile affixes in Huave: optimality and morphological well-formedness. In *Proceedings of the Twelfth West Coast Conference on Formal Linguistics*, edited by E. Duncan, D. Farkas, and P. Spaelti, 67-82. Stanford: CSLI.
- Noyer, Rolf. 1997. *Features, positions, and affixes in autonomous morphological structure*. New York & London: Garland.
- Odden, David. 1981. Problems in tone assignment in Shona. PhD dissertation. University of Illinois.
- Odden, David. 1987. Kimatuumbi phrasal phonology. *Phonology Yearbook* 4, 13-26.
- Odden, David. 2001. Tone shift and spread in Taita. *SAL* 30(1):75-110.
- Odden, David. 2006. Topics in Taita tone II. *SAL* 35(1):33-72.
- Odden, David, & Lee Bickmore. 2014. Melodic tone in Bantu: overview. *Africana Linguistica* 20.1 (2014): 3-14.
- Olawsky, Knut J. 2006. *A grammar of Urarina*. Vol. 37. Walter de Gruyter, 2006.
- Oostendorp, Mark van. 2004. The theory of faithfulness. Ms.
- Oostendorp, Mark van. 2006. A theory of morphosyntactic colours. Ms., Meertens Institute, Amsterdam. Available under: <http://egg.auf.net/06/docs/Hdt%20Oostendorp%20coulours.pdf>.
- Opitz, Andreas. 2008. Case and markedness in Tlapanec. *Linguistische Berichte* 214: 211-237.

- Orgun, Cemil Orhan. 1996. Sign-based Morphology and Phonology: With Special Attention to Optimality Theory. PhD dissertation. University of California, Berkeley.
- Orgun, Cemil Orhan, & Sharon Inkelas. 2002. Reconsidering Bracket Erasure. In *Yearbook of Morphology 2001*, 115–146. Springer.
- Pak, Marjorie. 2008. The postsyntactic derivation and its phonological reflexes. PhD Dissertation. University of Pennsylvania.
- Palancar, Enrique. 2016. A typology of tone and inflection: A view from the Oto-Manguan languages of Mexico. In Palancar, Enrique and Léonard, Jean-Léo (eds.), *Tone and Inflection: New facts under new perspectives*, 109–139. Berlin: De Gruyter Mouton.
- Palancar, Enrique, & Jean-Léo Léonard (eds.). 2016. *Tone and Inflection: New facts under new perspectives*. Berlin: De Gruyter Mouton.
- Pariante, Itsik. 2012. Grammatical paradigm uniformity. *Morphology* 22(4):485-514.
- Park, Indrek. 2012. A Grammar of Hidatsa. PhD dissertation. Indiana University.
- Paschen, Ludger. 2018. The interaction of reduplication and segmental mutation: A phonological account. PhD dissertation. University of Leipzig.
- Pater, Joe. 2000. Nonuniformity in English secondary stress: The role of ranked and lexically specific constraints. *Phonology* 17:237–274.
- Pater, Joe. 2007. The Locus of Exceptionality: Morpheme-Specific Phonology as Constraint Indexation. In University of Massachusetts Occasional Papers 32: Papers in Optimality Theory III. Leah Bateman, Michael O’Keefe, Ehren Reilly and Adam Werle (eds.). 259-296.
- Paulian, Christiane. 1975. *Le Kukuya, Langue Teke Du Congo: Phonologie, Classes Nominales*. Vol. 49. Peeters Publishers.
- Peng, S.-H. 1997. Production and perception of Taiwanese tones in different tonal and prosodic contexts. *Journal of Phonetics*, 25, 371–400
- Pennington, Ryan. 2014. Tone in Gadsup Noun Phrases. MS. SIL PNG.
- Pesetsky, David. 1979. Russian Morphology and Lexical Theory. Ms., MIT.
- Petit, Daniel. 2016. Force et dominance accentuelle en morphologie dérivationnelle grecque. In Alain Blanc and Daniel Petit (eds.), *Nouveaux acquis sur la formation des noms en grec ancien: Actes du colloque international, Université de Rouen, 17–18 octobre 2013*, 5–35. Louvain:Peeters.
- Pike, Kenneth L. 1948. *Tone Languages*. Ann Arbor.
- Plank, Franz. 2001. Typology by the end of the 18th century. In: Auroux, S. et al. (Eds.), *History of the Language Sciences: An International Handbook on the Evolution of the Study of Language from the Beginnings to the Present*, vol. 2. Mouton de Gruyter, Berlin, pp. 1399–1414.
- Plunkett, Gray C. 2009. An overview of Foodo, a linguistic island in Benin. *Journal of West African Languages* 36. 107-138.
- Pollard, C. and Sag, I. A. 1994. *Head-Driven Phrase Structure Grammar*. University of Chicago Press
- Poser, William. 1982. Phonological Representations and Action-at-a-Distance. *The Structure of Phonological Representations* 2: 121–58.
- Poser, William. 1984. The Phonetics and Phonology of Tone and Intonation in Japanese. PhD dissertation. Massachusetts Institute of Technology.
- Poser, William. 1990. Evidence for Foot Structure in Japanese. *Language* 66:78–105.
- Potisuk, S., Gandour, J., & Harper, M.P. 1997. Contextual variations in trisyllabic sequences of Thai tones. *Phonetica*, 54, 22–42.
- Potts, Christopher, & Geoffrey K. Pullum. 2002. Model Theory and the Content of OT Constraints. *Phonology* 19 (3): 361–93.
- Prince, Alan. 2002. Arguing Optimality. *Papers in Optimality Theory II* 26: 269–304.
- Prince, Alan, & Paul Smolensky. 1993. Optimality Theory: Constraint Interaction in Generative Grammar. Ms. Available on Rutgers Optimality Archive, ROA-537. [Published as 2004. *Optimality Theory: Constraint Interaction in Generative Grammar*. Malden, MA, and Oxford, UK: Blackwell]
- Prisca Jerono. 2013. Case Marking in Tugen. Paper presented at the Nilo-Saharan Linguistic Colloquium, 22-24 May 2013, Cologne.
- Probert, Philomen. 2006. *Ancient Greek Accentuation: Synchronic Patterns, Frequency Effects, and Prehistory*. Oxford / New York: Oxford University Press.
- Prokhorov, Kirill. 2011. Tonal head-marking in the Mombo noun phrase. *Afrikanische Sprachen im Fokus: Linguistische Beiträge zum 19. Afrikanistentag, Mainz, 8.–10. April 2010* (Afrikanistentage 9), ed. by Raija Kramer, Holger Tröbs, and Raimund Kastenholz, 209–22. Cologne: Köppe
- Pulleyblank, Douglas. 2004. A Note on Tonal Markedness in Yoruba. *Phonology* 21 (3): 409–25.

- Rainer, Franz. 1996. Inflection inside derivation: Evidence from Spanish and Portuguese. In Geert Booij & Jaap van Marle (eds.), *Yearbook of Morphology 1995*. Dordrecht: Kluwer. 83–91.
- Ralli, A. & L. Touradzidis. 1992. Computational processing in Greek [Ipologistiki epeksergasia tou tonismou tis Ellinikis]. *Studies in Greek Linguistics* 1992, 273-289. University of Thessaloniki.
- Ralli, A. 1988. Elements de morphologie du Grec Moderne. PhD dissertation. Université de Montréal.
- Rasch, Jeffrey. 2015. Yaitepec Chatino. In Timothy Feist and Enrique L. Palancar, the Oto-Manguean inflectional class database. University of Surrey. <www.smg.surrey.ac.uk/oto-manguean>
- Ratliff, Martha. 2010. *Meaningful Tone: A Study of Tonal Morphology in Compounds, Form Classes, and Expressive Phrases in White Hmong*. Northern Illinois University Press.
- Reinhart, Tanya. 1976. The syntactic domain of anaphora. PhD dissertation. MIT.
- Remijsen, Bert. 2010. Nouns and verbs in Magey Matbat. Ms.
- Remijsen, Bert, & Otto Ayoker. 2014. Contrastive Tonal Alignment in Falling Contours in Shilluk. *Phonology* 31: 435–62.
- Revithiadou, Anthi. 1999. *Headmost accent wins: head dominance and ideal prosodic form in lexical accent systems*. LOT Dissertation Series 15. HIL/Leiden Universiteit, The Hague: Holland Academic Graphics
- Revithiadou, Anthi. 2007. Colored turbid accents and containment: A case study from lexical stress. In Blaho, S., Bye, P., and Krämer, M., editors, *Freedom of Analysis?*, pages 149–174. Berlin & New York: Mouton De Gruyter.
- Richards, Norvin. 2011. A-Bar Dependencies. In *The Oxford Handbook of Linguistic Minimalism*. Edited by Cedric Boeckx.
- Richards, Norvin. 2016. *Contiguity Theory*. Vol. 73. MIT Press.
- Richards, R. M. 1991. Phonologie de trois langues beboïdes du Cameroun: Noone, Ncanti et Sali. PhD dissertation. Université de la Sorbonne Nouvelle, Paris III.
- Riggle, Jason, Max Bane, and Samuel R. Bowman. 2011. PyPhon. (A software package for finite-state Optimality Theory.)
- Rivierre, Jean-Claude. 1978. Accents tons et inversion tonale en nouvelle Calédonie. *Bulletin de la Société de Linguistique de Paris* 73.1: 415-443.
- Roberts, David. 2013. *La Conjugaison Des Verbes En Kabiye (Togo): Tableaux Types, Règles D'emploi et Index Kabiye-Français et Français-Kabiye Des Verbes*. Editions L'Harmattan.
- Roberts, David. 2016. Word Tone and Tonal Overwriting in Kabiye Nouns. *Journal of African Languages and Linguistics* 37 (1): 131–60.
- Rodewald, Michael. 1989. A grammar of Bandi and Mende tone. Ph.D. dissertation. University of Texas at Arlington.
- Rolle, Nicholas. 2016. Rhythmic Repair of Morphological Accent Assigned Outside of a Metrical Window. In Karen Jesney, Charlie O'Hara, Caitlin Smith, & Rachel Walker (eds.), *Supplemental Proceedings of the 2016 Annual Meeting on Phonology*. Washington, DC: Linguistic Society of America.
- Rolle, Nicholas. 2018. Transparadigmatic Output-Output Correspondence: A Case Study from Ese Ejja. *Proceedings of the Annual Meetings on Phonology*. Vol. 5. 2018.
- Rolle, Nicholas. accepted. In support of an OT-DM model: Evidence from a morphological conspiracy in Degema. [Accepted for publication in *Natural Language & Linguistic Theory*.]
- Rolle, Nicholas. in press. Output-Output Correspondence via Agreement by Projection. In Sherry Hucklebridge & Max Nelson (eds), *NELS 48 Proceedings*. Amherst, MA: GLSA Publications.
- Rolle, Nicholas & Marine Vuillermet. In press. Morphologically assigned accent and an initial three syllable window in Ese Ejja. In Rob Goedemans, Harry van der Hulst & Jeffrey Heinz (eds.), *The study of word stress and accent: Theories, methods and data*. Cambridge: Cambridge University Press.
- Rolle, Nicholas, Matthew Faytak, and Florian Lionnet. 2017. The Distribution of Advanced Tongue Root Harmony and Interior Vowels in the Macro-Sudan Belt. *Proceedings of the Linguistic Society of America*.
- Rose, Sharon, and Rachel Walker. 2004. A Typology of Consonant Agreement as Correspondence. *Language* 80 (3): 475–531
- Roulon-Doko, Paulette. 1995. Le gbaya. In Boyd, Raymond. 1995. *Le système verbal dans les langues oubangiennes*. 25-80.
- Rubach, Jerzy. 2008. An Overview of Lexical Phonology. *Language and Linguistics Compass* 2 (3): 456–77.
- Saba Kirchner, J. 2010. Minimal Reduplication. PhD dissertation. University of California at Santa Cruz.
- Sadler, Wesley. 2006. A complete analysis of the Lɔ̄oma language (Interior Liberia, West Africa). *Mandenkan* 42:5-109.
- Sande, Hannah. 2017. Distributing Morphologically Conditioned Phonology: Three Case Studies from Guébie. PhD dissertation. University of California, Berkeley.
- Sande, Hannah, & Peter Jenks. 2017. Cophonologies by Phase. Paper presented at *NELS 48*, University of Iceland.

- Sandell, Ryan. 2011. The Morphophonology of Reduplicated Presents in Vedic and Indo-European. In Stephanie W. Jamison, H. Craig Melchert and Brent Vine (eds.), *Proceedings of the 22nd Annual UCLA Indo-European Conference*, 223–254. Bremen: Hempen.
- Sandy, Clare S. 2014. Tone and syllable structure in Karuk (Hokan, California). In P. Littell, A. Gutiérrez, R. Girard, and N. Weber (eds.), *Papers from the Seventeenth Workshop on Structure and Constituency in the Languages of the Americas (WSCLA 17)*, University of Chicago, Chicago, Illinois, March 9-11 2012. University of British Columbia Working Papers in Linguistics 36:37-58.
- Sandy, Clare S. 2017. Prosodic Prominence in Karuk. PhD dissertation. University of California, Berkeley.
- Savà, Graziano. 2005. *A Grammar of Ts'amakko*. Vol. 22. Köppe.
- Schadeberg, Thilo C., & Francisco Ussene Mucanheia. 2000. *Ekoti: The Maka or Swahili Language of Angoche*. Köppe.
- Schaefer, Ronald P., & Francis O. Egbokhare. 2017. *A Grammar of Emai*. Volume 72 of Mouton grammar library.
- Scheer, Tobias. 2011. *A Guide to Morphosyntax-Phonology Interface Theories: How Extra-Phonological Information Is Treated in Phonology since Trubetzkoy's Grenzsignale*. Walter de Gruyter.
- Schneeberg, Nan. 1974. Sayanci Phonology. PhD dissertation. Indiana University.
- Schoorlemmer, Erik, & Tanja Temmerman. 2012. Head Movement as a PF-Phenomenon: Evidence from Identity under Ellipsis. In *Proceedings of the 29th West Coast Conference on Formal Linguistics*, 232–240. Cascadilla Proceedings Project Somerville, MA.
- Schrock, Terrill B. 2014. *A Grammar of Ik (Icé-Tód): Northeast Uganda's Last Thriving Kuliak Language*. LOT: Utrecht.
- Schuh, Russell G. 2017. A Chadic Cornucopia. Ms.
- Schuh, Russell G., & Alhaji Maina Gimba. 2005. Low tone raising in Bole. *Afrika und Übersee* 88: 229–264.
- Selkirk, Elisabeth. 1980. Prosodic domains in phonology: Sanskrit revisited. In M. Aronoff & M.-L. Kean (eds.) *Juncture*. Saratoga, CA: Anma Libri.
- Selkirk, Elisabeth. 1984. *Phonology and Syntax: The Relation between Sound and Structure*. Cambridge: MIT Press.
- Selkirk, Elisabeth. 1995. Sentence prosody: intonation, stress, and phrasing. In John A. Goldsmith (ed.), *The handbook of phonological theory*. Cambridge, Mass. & Oxford: Blackwell. 550–569.
- Selkirk, Elisabeth. 2009. On Clause and Intonational Phrase in Japanese: The Syntactic Grounding of Prosodic Constituent Structure. *Gengo Kenkyu* 136: 35–73.
- Selkirk, Elisabeth. 2011. The syntax-phonology interface. *The handbook of phonological theory 2*. 435–483.
- Shih, Stephanie, & Sharon Inkelas. 2016. Morphologically-conditioned tonotactics in multilevel Maximum Entropy grammar. In Gunnar Ólafur Hansson; Ashley Farris-Trimble; Kevin McMullin; and Douglas Pulleyblank (eds.) *Proceedings of the 2015 Annual Meeting on Phonology*. Washington, DC: Linguistic Society of America.
- Shih, Stephanie, & Kie Ross Zuraw. 2017. Phonological conditions on variable adjective-noun word order in Tagalog. *Language: Phonological Analysis*. 93(4): e317–e352.
- Siddiqi, Daniel. 2014. The Syntax-Morphology Interface. In Carnie, Andrew, Dan Siddiqi, & Yosuke Sato, eds. *The Routledge handbook of syntax*. Routledge, 2014.
- Siegel, Dorothy Carla. 1974. Topics in English Morphology. PhD dissertation. Massachusetts Institute of Technology.
- Skilton, Amalia. 2017. Ticuna tone. Unpublished PhD Prospectus. University of California, Berkeley.
- Skilton, Amalia, & Stephanie Farmer. 2015. Maihiki serial verb constructions challenge the typology of one-word serial verbs. Paper presented at the Society for the Study of Indigenous Languages of the Americas Annual Meeting. Portland, OR.
- Smith, Tony & Richard Gravina. *The phonology of two central Chadic languages*. SIL International Publications.
- Smolders, Joshua. 2016. A Phonology of Ganza (Gwàmi Nánà). *Linguistic Discovery* 14 (1): 86–144.
- Smolensky, Paul. 1996. The Initial State and 'richness of the Base' in Optimality Theory. Ms. Rutgers Optimality Archive 293.
- Smolensky, Paul, & Matthew Goldrick. 2016. Gradient Symbolic Representations in Grammar: The Case of French Liaison. Ms. Johns Hopkins University and Northwestern University. Available as ROA 1286.
- Smolensky, Paul, & Géraldine Legendre. 2006. *The Harmonic Mind: From Neural Computation to Optimality-Theoretic Grammar* (Cognitive Architecture), Vol. 1. MIT press.
- Spencer, Andrew, & Arnold M. Zwicky. 1998. *The handbook of morphology*. Oxford: Blackwell.
- Stanton, Juliet & Donca Steriade. 2014. Stress windows and base faithfulness in English suffixal derivatives. Paper presented at 22mfm Meeting. 2014 May 29.
- Staubs, Robert, Michael Becker, Christopher Potts, Patrick Praat, John McCarthy, & Joe Pater. 2010. OT-HELP 2. Software Package. University of Massachusetts, Amherst.
- Steriade, Donca. 1988. Greek accent: A case for preserving structure. *Linguistic Inquiry* 19: 271–314.

- Steriade, Donca. 2000. Paradigm uniformity and the phonetics-phonology boundary. In M. Broe & J. Pierrehumbert (eds.), *Papers in laboratory phonology V. Acquisition and the lexicon*. Cambridge: CUP. 313–334
- Steriade, Donca. 2012. The Cycle without Containment: Latin Perfect Stems. Unpublished ms.
- Stirtz, Timothy M. 2011. A Grammar of Gaahmg – A Nilo-Saharan Language of Sudan. PhD dissertation. Leiden University.
- Stump, Gregory T. 2001. *Inflectional Morphology: A Theory of Paradigm Structure*. Vol. 93. Cambridge University Press.
- Sullivant, John Ryan. 2015. The phonology and inflectional morphology of Chá?knyá, Tataltepec de Valdés Chatino, a Zapotecan language. PhD dissertation. University of Texas, Austin.
- Svenonius, Peter. 2016. Spans and Words. In *Morphological Metatheory*, ed. by Daniel Siddiqi and Heidi Harley, 201–222. John Benjamins, Amsterdam.
- Thwing, Rhonda, & John Watters. 1987. Focus in Vute. *Journal of African Languages and Linguistics* 9(2):95–122.
- Tranel, Bernard. 1995. The phonology of Mixteco's floating high tones: theoretical implications. Unpublished ms. University of Irvine.
- Trommer, Jochen. 2001a. Distributed Optimality. PhD dissertation. Universität Potsdam.
- Trommer, Jochen. 2001b. A Hybrid Account of Affix Order. *Proceedings of CLS 37*: 469–80.
- Trommer, Jochen. 2002. Modularity in OT-Morphosyntax. In Caroline Féry (ed.) *Resolving Conflicts in Grammar: Optimality Theory in Syntax, Morphology and Phonology*. Special, no. 11.
- Trommer, Jochen. 2011. Phonological aspects of Western Nilotic mutation morphology. Habilitation. Leipzig University.
- Trommer, Jochen. 2013. Stress Uniformity in Albanian: Morphological Arguments for Cyclicity. *Linguistic Inquiry* 44(1):109–43.
- Trommer, Jochen, & Eva Zimmermann. 2014. Generalised mora affixation and quantity manipulating morphology. *Phonology* 31, 463–510.
- Tsay, Jane S. 1990. Constraining lexical accent. *Proceedings of the North East Linguistic Society* 21, 351–365. Graduate Linguistic Student Association, University of Massachusetts, Amherst.
- Tucker, A. N., & J. Tompo Ole Mpaayei. 1955. *A Maasai Grammar with Vocabulary*. Publications of the African Institute, Leyden 2. London: Longmans, Green & Co.
- Tucker, Matthew A. 2011. The morphosyntax of the Arabic verb: Toward a unified syntax-prosody. *Series: Morphology at Santa Cruz: Papers in Honor of Jorge Hankamer*. Linguistics Research Center. 177–211. Permalink: <https://escholarship.org/uc/item/0wx0s7qw>
- Uchihara, Hiroto. 2016. *Tone and Accent in Oklahoma Cherokee*. Vol. 3. Oxford University Press.
- Urbanczyk, Suzanne. 2011. Root-Affix Asymmetries. In *The Blackwell Companion to Phonology*, 1–26.
- Uriagereka, Juan. 2011. Derivational Cycles. In *The Oxford Handbook of Linguistic Minimalism*. Edited by Cedric Boeckx.
- Uriagereka, Juan. 2012. *Spell-Out and the Minimalist Program*. OUP Oxford.
- Ussishkin, Adam. 1999. The Inadequacy of the Consonantal Root: Modern Hebrew Denominal Verbs and Output–output Correspondence. *Phonology* 16 (3): 401–42.
- Ussishkin, Adam, & Andrew Wedel. 2002. Neighborhood Density and the Root-Affix Distinction. In *Proceedings of NELS*, 32:539–550.
- Vaxman, Alexandre. 2016a. How to Beat without Feet: Weight Scales and Parameter Dependencies in the Computation of Word Accent. PhD dissertation. University of Connecticut. <https://opencommons.uconn.edu/dissertations/1266>
- Vaxman, Alexandre. 2016b. Diacritic Weight in the Extended Accent First Theory. *University of Pennsylvania Working Papers in Linguistics* 22 (1).
- Villard, Stéphanie. 2015. The phonology and morphology of Zacatepec Eastern Chatino. PhD dissertation. University of Texas, Austin.
- Voorhoeve, Jan. 1971. Tonology of the Bamileke noun. *Journal of African Languages* 10(2):44–53.
- Vuillermet, Marine. 2012. A Grammar of Ese Ejja. PhD dissertation. Université Lumière Lyon 2.
- Waag, Christine, & Martin Phodunze. 2015. The Pronominal System of Baka, a Central Sudanic Language of South Sudan. In *Nilo-Saharan: Models and Descriptions*, 135–50. Cologne: Köppe.
- Wal, Jenneke van der. 2006. Predicative Tone Lowering in Makhwa. *Linguistics in the Netherlands* 23 (1): 224–36.
- Wal, Jenneke Van der, & Larry M. Hyman. 2017. *The Conjoint/disjoint Alternation in Bantu*. Vol. 301. Walter de Gruyter GmbH & Co KG.
- Wang, C.-M. Bonnie. 2014. The Prosody-syntax Interaction in the yi-bu-qi-ba Rule: a Morphologically Conditioned Tone Change in Mandarin Chinese. Master of Arts thesis. University of North Carolina at Chapel Hill.
- Welmers, William. 1969. The morphology of Kpelle nominals. *Journal of African Languages* 8:73–101.
- Welmers, William. 1973. *African Language Structures*. Berkeley and Los Angeles: University of California Press.

- Werner, Roland. 1993. *Tidn-Áal: A Study of Midob (Darfur-Nubian)*. Vol. 17. D. Reimer.
- Wiering, Elisabeth, and Marinus Wiering. 1994. *The Doyayo language: selected studies*. Vol. 121. Howard University Press Library.
- Willard, E. Rainbow. 2004. Dominance effects in a dialect of Mam Maya. Paper presented at Linguistic Society of America annual meeting, Boston.
- Williams, Cindy. 2004. An analysis of Amuzgo nominal tone. In R. Beam de Azcona y M. Paster (Eds.), *Conference on Oto-manguean and Oaxacan Languages* [Survey of California and Other Indian Languages Report 13], Berkeley, CA: SCOIL, pp. 147-161.
- Williamson, Kay. 1965. *A grammar of the Kolokuma dialect of Ijo*. West African Language Monograph Series, no. 2.
- Williamson, Kay. 1988. Tone and accent in Ijo. In Harry van der Hulst & Norval Smith (eds), *Autosegmental studies on pitch accent*, 253-278. Dordrecht: Foris Publications.
- Wolf, Matthew. 2007. For an autosegmental theory of mutation. In Bateman, L., O'Keefe, M., Reilly, E., and Werle, A., editors, *University of Massachusetts Occasional Papers in Linguistics 32: Papers in Optimality Theory III*, pages 315–404. Amherst: GLSA.
- Wolf, Matthew. 2008. Optimal Interleaving: Serial Phonology-Morphology Interaction in a Constraint-Based Model. PhD dissertation. University of Massachusetts, Amherst.
- Xu, Baohua, Zhenzhu Tang, & Nairong Qian. 1981. Xinpai Shanghai fangyan de liandu biandiao (Tone sandhi in New Shanghai). *Fangyan (Dialects)*. 145–155.
- Xu, Y. 1997. Contextual tonal variations in Mandarin. *Journal of Phonetics*, 25:61–83.
- Yang, Bei. 2015. *Perception and Production of Mandarin Tones by Native Speakers and L2 Learners*. Springer.
- Yates, Anthony David. 2017. Lexical Accent in Cupeño, Hittite, and Indo-European. PhD dissertation. UCLA.
- Yip, Moira. 2002. *Tone*. Cambridge University Press.
- Yue-Hashimoto, A.O. 1987. Tone sandhi across Chinese dialects. In Chinese Language Society of Hong Kong. Wang Li memorial volumes, English volume. Hong Kong: Joint Publishing Co. 445–474.
- Yukawa, Y. 1992. A tonological study of Bulu verbs. In *Studies in Cameroonian and Zairean Languages*, volume 3, pages 67–94. Institute for the Study of Languages and Cultures of Asia and Africa (ILCAA), Tokyo University of Foreign Studies, Tokyo.
- Zhang, Jie. 2007. A directional asymmetry in Chinese tone sandhi systems. *Journal of East Asian Linguistics*, 16:259–302.
- Zhang, Jie. 2014. Tones, tonal phonology, and tone sandhi. In C.-T.J. Huang, Y.-H.A. Li, & A. Simpson (eds.), *The handbook of Chinese linguistic*. 443–464. Oxford, UK: Wiley Blackwell.
- Zhang, Jie, & Liu, J. 2011. Tone sandhi and tonal coarticulation in Tianjin Chinese. *Phonetica*, 68(3):161–191.
- Zhang, Jie, & Yuanliang Meng. 2016. Structure-dependent tone sandhi in real and nonce words in Shanghai Wu. *Journal of Phonetics* 54.1: 169-201.
- Zhel'tov, Alexander Jurievich. 2005. Le Système Des Marqueurs de Personnes En Gban: Morphème Syncrétique Ou Syncrétisme Des Morphèmes ? *Mandenkan* 41:23–28.
- Zimmermann, Eva. 2016. The power of a single representation: morphological tone and allomorphy. *Morphology* 26(3-4):269-294.
- Zimmermann, Eva. 2017. *Morphological Length and Prosodically Defective Morphemes*, Volume 1 of Oxford studies in phonology and phonetics. Oxford: University Press.
- Zoll, Cheryl. 1996. Parsing Below the Segment in a Constraint-Based Framework. PhD dissertation. University of California, Berkeley.
- Zwicky, Arnold & Geoffrey Pullum. 1986. The principle of phonology-free syntax: introductory remarks. *Ohio State University Working Papers in Linguistics* 32, 63-91.