

# The rich internal structure of gradable adjectives: Evidence from diminutive adjectives in Czech

Guido Vanden Wyngaerd      Pavel Caha      Karen De Clercq

## Abstract

The chapter provides evidence from Czech for the existence of at least three functional heads in a gradable adjective (Vanden Wyngaerd et al. 2020). The heads are (i) a dimension DIM (such as *speed*), (ii) a direction DIR (distinguishing antonymous adjectives such as *fast vs. slow*), and (iii) a standard of comparison, abbreviated as POINT. Evidence for this rich internal structure comes from the morphology of positive-degree adjectives, which can be morphologically complex, showing either the suffix *n* or *k*. These morphemes interact differently with the diminutive morpheme *ouč*, with *n* preceding the diminutive, and *k* following it. This indicates that *n* and *k* occupy two different positions. When we consider the position for the root in addition, we have three positions for the adjective in total. Based on the distribution of the adjectival suffixes *n* and *k* in the comparative, we furthermore distinguish six different classes of adjectives. Using a nanosyntactic approach (Starke 2018), we argue that this complex distribution can be accounted for by assuming a decomposition of the comparative into three different heads, the idea that roots vary in size, and the existence of lexical items with complex left branches (Blix 2022).

**Key words:** adjectives, diminutives, comparative, nanosyntax

## 1 Introduction

Czech positive-degree adjectives fall into three different classes. In the first class, the root is directly followed by the agreement marker *ý* (1a). The second class consists of adjectives whose root is followed by a morpheme *n*, which we shall refer to as an ‘augment’ or AUG (1b). Finally, a relatively smaller class requires the augment *k* (1c).

- (1) a. *mlad- ý*  
young AGR  
‘young’  
b. *snad- n- ý*  
easy AUG AGR  
‘easy’  
c. *slad- k- ý*  
sweet AUG AGR  
‘sweet’

Table 1 gives a sample of some relevant examples of each of the three classes.

Table 1: Three kinds of positive degree adjectives in Czech

POS	GLOSS	POS	GLOSS	POS	GLOSS
blb-ý	‘stupid’	čer-n-ý	‘black’	blíz-k-ý	‘close’
čir-ý	‘pure’	drs-n-ý	‘rough’	břit-k-ý	‘sharp’
čist-ý	‘clean’	hluč-n-ý	‘noisy’	heb-k-ý	‘smooth’
dlouh-ý	‘long’	hod-n-ý	‘kind’	hlad-k-ý	‘smooth’
dobr-ý	‘good’	jas-n-ý	‘clear’	hoř-k-ý	‘bitter’
drah-ý	‘expensive’	jem-n-ý	‘smooth’	krát-k-ý	‘short’
drz-ý	‘cheeky’	krás-n-ý	‘beautiful’	krot-k-ý	‘tame’
hloup-ý	‘stupid’	lev-n-ý	‘cheap’	křeh-k-ý	‘fragile’
hust-ý	‘dense’	mast-n-ý	‘fatty’	leh-k-ý	‘easy’
chud-ý	‘poor’	mír-n-ý	‘peaceful’	měk-k-ý	‘soft’
jist-ý	‘secure’	něž-n-ý	‘tender’	měl-k-ý	‘shallow’
krut-ý	‘cruel’	pěk-n-ý	‘pretty’	mrz-k-ý	‘meager’
mal-ý	‘small’	pev-n-ý	‘firm’	níz-k-ý	‘low’
mil-ý	‘lovely’	pl-n-ý	‘full’	prud-k-ý	‘steep’
mlad-ý	‘young’	prázd-n-ý	‘empty’	plyt-k-ý	‘shallow’
nah-ý	‘naked’	rov-n-ý	‘straight’	říd-k-ý	‘thin’
plach-ý	‘timid’	sil-n-ý	‘strong’	slad-k-ý	‘sweet’
ploch-ý	‘flat’	sla-n-ý	‘salty’	sliz-k-ý	‘slimy’
slab-ý	‘weak’	slav-n-ý	‘famous’	ten-k-ý	‘thin’
slep-ý	‘blind’	sluš-n-ý	‘kind’	těž-k-ý	‘heavy’
star-ý	‘old’	skrom-n-ý	‘modest’	trp-k-ý	‘sour-bitter’
such-ý	‘dry’	smut-n-ý	‘sad’	úz-k-ý	‘narrow’
tich-ý	‘quiet’	snad-n-ý	‘easy’	vel-k-ý	‘big’
tup-ý	‘blunt’	šťast-n-ý	‘happy’	vlh-k-ý	‘wet’
tvrd-ý	‘hard’	tuč-n-ý	‘fat’	vrat-k-ý	‘unstable’
zl-ý	‘evil’	vol-n-ý	‘free’	brz-k-ý	‘early’

We start out by investigating the distribution of these augments in the positive, showing that it is governed by the arbitrary class of the root (section 2). We then investigate their interaction with the diminutive morpheme, arguing that at least three heads are needed (section 3). We next propose an account based on two ingredients, the first being the decomposition of adjectival meaning into smaller atoms (section 4), and the second the idea that roots realise different sets of these ingredients (sections 5 and 6). Then, we investigate the distribution of augments in comparatives, arguing that they support the decomposition of the comparative head into three different atoms (section 7). Finally, we show that root size does not suffice to capture the full range of the data, and that root shape is a second variable factor that needs to be assumed in the structure of lexical entries (section 8).

## 2 Arbitrary distribution

As a first point in this section, we want to show that the distribution of *n* is not governed by phonology. There are homonymous roots like *lev*, which in one meaning take *n* (2a),

but do not in the other meaning (2b).

- (2) a. *lev- n- á noha*  
cheap AUG AGR leg  
'(the) cheap leg'  
b. *lev- á noha*  
left AGR leg  
'(the) left leg'

The distribution of *n* is not governed by semantics, either, since there are synonymous roots, where one root takes *n*, and the other does not.

- (3) a. *drs- n- á pokožka*  
rough AUG AGR skin  
'a rough skin'  
b. *hrub- á pokožka*  
rough AGR skin  
'a rough skin'

Finally, the distribution of *n* is not governed by the morphological category of the base. For example, some *n* adjectives are derived from nouns, such as the one in (4a), but not all of them are, as (5) shows.

- (4) a. *čest- n- ý*  
honest AUG AGR  
'honest'  
b. *čest*  
honour  
'honour'

- (5) a. *skrom- n- ý*  
modest AUG AGR  
'modest'  
b. \**skrom*  
Int: 'modesty'

Conversely, we also see that nouns can become adjectives with or without *n*.

- (6) a. *stříbr- o*  
silver NOM.NEUT.SG  
'silver (metal)'  
b. *stříbr- n- ý*  
silver AUG AGR  
'silver (color/material)'
- (7) a. *zlat- o*  
gold NOM.NEUT.SG  
'gold (metal)'  
b. *zlat- ý*  
gold AGR

‘golden (color/material)’

Putting this evidence together, we can conclude that the presence or absence of the augment *n* is an arbitrary property of the root.

We next turn to the augment *k*, where a similar argument can be made. The distribution of *k* is unlikely to be governed by the phonology, as there are nearly identical roots, where one root takes *k*, one takes *n*, and yet another one does not have any augment at all.

- (8) a. *slad-* *k-* *ý*  
smooth AUG AGR  
‘sweet’  
b. *klad-* *n-* *ý*  
positive AUG AGR  
‘positive’  
c. *mlad-* *ý*  
young AGR  
‘young’

That the distribution of *n* vs *k* is not governed by semantics is shown by the fact that there are synonymous roots, where one root takes *k*, and the other *n*.

- (9) a. *hez-* *k-* *á* *hudba*  
nice AUG AGR music  
‘nice music’  
b. *pěk-* *n-* *á* *hudba*  
nice AUG AGR music  
‘nice music’

There are also near synonymous roots, where one root takes *k*, the other *n*, and yet another one takes no augment.

- (10) a. *leh-* *k-* *á* *úloha*  
light AUG AGR task  
‘an easy task’  
b. *snad-* *n-* *á* *úloha*  
easy AGR task  
‘an easy task’  
c. *jednoduch-* *á* *úloha*  
simple AGR task  
‘a simple task’

Finally, the distribution of *k* is not governed by the morphological category of the base. As with the *n* augment, some *k* adjectives are derived from nouns, but not all of them are.

- (11) a. *sliz-* *k-* *ý*  
slime AUG AGR  
‘slimy’

- b. *sliz*  
slime
- (12) a. *heb-* *k-* *ý*  
smooth AUG AGR  
'smooth'
- b. \**heb*  
Int.: 'smoothness'

Also, when we look at scale type and orientation, we see that these properties are not good predictors of the distribution of the augments. In Table 2, we list some positive and negative adjectives next to each other. The top section of the table focuses on the augment *n*. The augment shows up both in the positive or in the negative column (first two rows), or in both (third row). The scales, whose type is listed in the final column, may also be of different types, including open, closed, and partially closed scales, but these types do not correlate with the presence or absence of *n*. The same conclusion can be drawn from the middle section of the table, which focuses on adjectives with *k*. The bottom section of the table shows that augmentless adjectives may, too, be associated to either positive, negative, or both ends of the scale. Here too there is no correlation between scale type or orientation and the augments.

Table 2: Augments and scale type and orientation

POS	GLOSS	NEG	GLOSS	SCALE
<i>sil-n-ý</i>	'strong'	<i>slab- ý</i>	'weak'	OPEN
<i>drah- ý</i>	'expensive'	<i>lev-n-ý</i>	'cheap'	OPEN
<i>šťast-n-ý</i>	'happy'	<i>smut-n-ý</i>	'sad'	OPEN
<i>jas-n-ý</i>	'clear'	<i>ne-jas-n-ý</i>	'un-clear'	PARTIALLY CLOSED
<i>pl-n-ý</i>	'full'	<i>prázd-n-ý</i>	'empty'	CLOSED
<i>vel-k-ý</i>	'big'	<i>mal- ý</i>	'small'	OPEN
<i>tvrđ- ý</i>	'hard'	<i>měk-k-ý</i>	'soft'	OPEN
<i>těž-k-ý</i>	'heavy'	<i>leh-k-ý</i>	'light'	OPEN
<i>such- ý</i>	'dry'	<i>vlh-k-ý</i>	'wet'	PARTIALLY CLOSED
<i>hlad-k-ý</i>	'smooth'	<i>drs-n-ý</i>	'rough'	PARTIALLY CLOSED
<i>star- ý</i>	'old'	<i>mlad- ý</i>	'young'	OPEN
<i>tlust- ý</i>	'thick'	<i>ten-k-ý</i>	'thin'	OPEN
<i>dlouh- ý</i>	'long'	<i>krát-k-ý</i>	'short'	OPEN
<i>dobr- ý</i>	'good'	<i>špat-n-ý</i>	'bad'	OPEN
<i>hluč-n-ý</i>	'noisy'	<i>tich- ý</i>	'silent'	PARTIALLY CLOSED

The conclusion we can draw on the basis of the data discussed in this section is that the presence or absence of the augments *n* or *k* is not predictable from phonological, semantic, or morphological factors, but is an arbitrary property of the root.

### 3 The position of the augment in the morphological structure

As a first approximation of the position of the augments in the morphological structure, we could adopt the hypothesis that there is a dedicated head for them; for concreteness, take this to be the little *a* head that categorises the root. This head can dominate a null morpheme, or either of the two augments, as shown in (13). Given that we have shown that the distribution of these augments is governed by the kind of root that is inserted under  $\sqrt{\quad}$ , and adopting a DM-style approach to lexical insertion, augment distribution would be accounted for by adopting the three Vocabulary Items in (14).

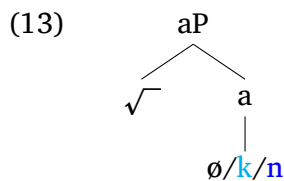

- (14) Vocabulary Items for three augments
- a.  $a \Leftrightarrow \emptyset$
  - b.  $a \Leftrightarrow n / \text{Class-}n \text{ \_\_\_}$
  - c.  $a \Leftrightarrow k / \text{Class-}k \text{ \_\_\_}$

The VI in (14a) would be the default or Elsewhere form, to be inserted except when a more specific item applies, like the ones in (14b-c), which insert *n* and *k* in the context of roots that are marked by an arbitrary diacritic, like ‘Class-*n*’ and ‘Class-*k*’, respectively. Blevins (2016: 73) argues that such facts show that words should not be decomposed, because they are more than pure sums of their parts. Arbitrary diacritics, in his view, are “assembly instructions’ that restore information about the co-occurrence of stems and exponents,’ which has been lost after decomposition. Although we do not agree with Blevins’ conclusion, we do share his objections against the use of diacritics to distinguish different classes of roots. In our view, a restrictive model of (universal) grammar only includes features that are drawn from a universal set of features like plural or animacy, but not features like ‘I require *n*’. One of our goals here is to show that nanosyntax offers a way of decomposing (and recomposing) adjectives without the need for diacritics.

Our path towards this proposal starts from the fact that Slavic adjectives, including Czech ones, can generally be modified by a diminutive suffix. In Czech, this suffix can take various forms, like *in*, *oun*, or *ouč*. Diminutive adjectives have an endearing sense, reflecting a positive sentiment towards the addressee. If we add such a diminutive suffix, we see that it precedes the *k*-augment, as shown in Table 3.

POS	DMV	GLOSS
heb- <i>k</i> -ý	heb- <b>ouč</b> - <i>k</i> -ý	‘smooth’
sliz- <i>k</i> -ý	sliz- <b>ouč</b> - <i>k</i> -ý	‘slimy’
křeh- <i>k</i> -ý	křeh- <b>ouč</b> - <i>k</i> -ý	‘fragile’
vlh- <i>k</i> -ý	vlh- <b>ouč</b> - <i>k</i> -ý	‘wet’
leh- <i>k</i> -ý	leh- <b>ouč</b> - <i>k</i> -ý	‘easy’
měk- <i>k</i> -ý	měk- <b>ouč</b> - <i>k</i> -ý	‘soft’
ten- <i>k</i> -ý	ten- <b>ouč</b> - <i>k</i> -ý	‘thin’
slad- <i>k</i> -ý	slad’- <b>ouč</b> - <i>k</i> -ý	‘sweet’
hlad- <i>k</i> -ý	hlad’- <b>ouč</b> - <i>k</i> -ý	‘smooth’
níz- <i>k</i> -ý	niz- <b>ouč</b> - <i>k</i> -ý	‘low’
blíz- <i>k</i> -ý	bliz- <b>ouč</b> - <i>k</i> -ý	‘near’
úz- <i>k</i> -ý	uz- <b>ouč</b> - <i>k</i> -ý	‘narrow’
krát- <i>k</i> -ý	krať- <b>ouč</b> - <i>k</i> -ý	‘short’

As a first approximation of the structure of such diminutive adjectives, we assume that there is a head DMV between the root and the position for the augment:

(15)

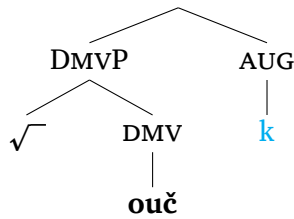

However, this structure does not suffice, which transpires upon consideration of the position of the *n*-augment, which precedes the diminutive marker. This is illustrated in Table 4. We furthermore see that, with the *n*-adjectives, the augment *k* also appears following the diminutive marker, resulting in the presence of the two augments in a single form.

POS	DMV	GLOSS
lev- <i>n</i> -ý	lev- <b>ň-ouč</b> - <i>k</i> -ý	‘cheap’
hod- <i>n</i> -ý	hod- <b>ň-ouč</b> - <i>k</i> -ý	‘kind’
šťast- <i>n</i> -ý	šťast- <b>ň-ouč</b> - <i>k</i> -ý	‘happy’
jem- <i>n</i> -ý	jem- <b>ň-ouč</b> - <i>k</i> -ý	‘smooth’
skrom- <i>n</i> -ý	skrom- <b>ň-ouč</b> - <i>k</i> -ý	‘modest’
něž- <i>n</i> -ý	něž- <b>ň-ouč</b> - <i>k</i> -ý	‘gentle’
sluš- <i>n</i> -ý	sluš- <b>ň-ouč</b> - <i>k</i> -ý	‘kind’
pěk- <i>n</i> -ý	pěk- <b>ň-ouč</b> - <i>k</i> -ý	‘pretty’
mír- <i>n</i> -ý	mír- <b>ň-ouč</b> - <i>k</i> -ý	‘peaceful’

In structural terms, this suggests that the *n*-augment and the *k*-augment occupy dif-

ferent positions, which we mark as AUG-LOW and AUG-HIGH, respectively, in the tree in (16).

(16)

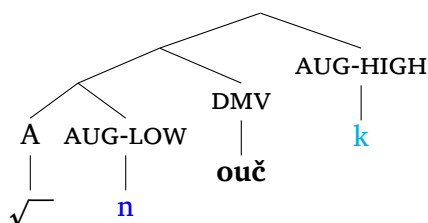

The fact that we can see both augments raises the obvious question why they never combine when there is no DMV. Before we get to the analysis, let us mention that the augmentless adjectives show the same peculiarity as the *n*-adjectives when combined with a diminutive. This causes the augment *k* to appear following the diminutive. Some relevant examples are given in Table 5.

Table 5: The zero class

POS	DMV	GLOSS
slab- ý	slab- ouč-k-ý	‘weak’
tup- ý	tup- ouč-k-ý	‘blunt’
slep- ý	slep- ouč-k-ý	‘blind’
mal- ý	mal- ouč-k-ý	‘small’
dobr- ý	dobr- ouč-k-ý	‘good’
čist- ý	čist- ouč-k-ý	‘clean’
hloup- ý	hloup- ouč-k-ý	‘stupid’
such- ý	such- ouč-k-ý	‘dry’

The general question that these facts raise is how the distributional pattern that we just discussed can be best analysed. As a first step towards answering this question, we shall first put forth a proposal as to the features that are realized by what we have in this section, rather uninformatively, called AUG-LOW and AUG-HIGH. This is the topic of the next section, which introduces a decomposition of adjectival meaning as proposed in Vanden Wyngaerd et al. (2020).

## 4 Decomposing adjectives

Gradable adjectives involve an ordering along a dimension (Cresswell 1976, Kennedy 2001). We therefore take them to minimally contain the features DIM (for DIMENSION) and DIR (for DIRECTION). There may also be an optional scale reverser NEG, in so far as the same scale can be positive (e.g. *tall*) or negative (e.g. *short*). Negative adjectives have NEG (De Clercq & Vanden Wyngaerd 2019). The interpretation of gradable adjectives typically involves a standard of comparison, which we represent as a POINT on the scale. This decomposition is summarised in (17).



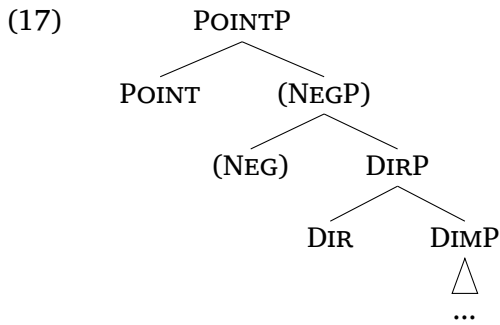

We represent a scale graphically as in Figure 1. The dimension of the scale in this example is that of height. Its orientation (indicated by the arrow) is positive, and the standard is a point on the scale, indicated by STD. In the positive degree, the standard is given contextually, and the interpretation is that the subject has a degree that is upward of the point indicated by STD, as shown by the bracket.

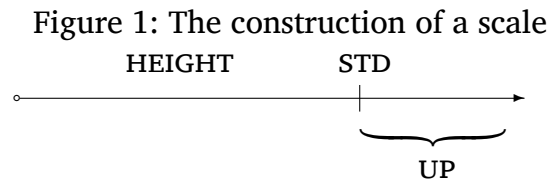

The decomposition of the adjective described above (due to Vanden Wyngaerd et al. (2020)) is of a sufficiently high resolution so as to be able to accommodate the two distinct augments, which we have labelled AUG-LOW and AUG-HIGH in the previous section. The simplest way to achieve this is to assume that there is an optional diminutive head between POINT and DIR. This leads to a structure, shown in (18a), which is closely parallel to the one we assumed in the previous section (18b), with basically only the labels of the nodes being different.<sup>1</sup>

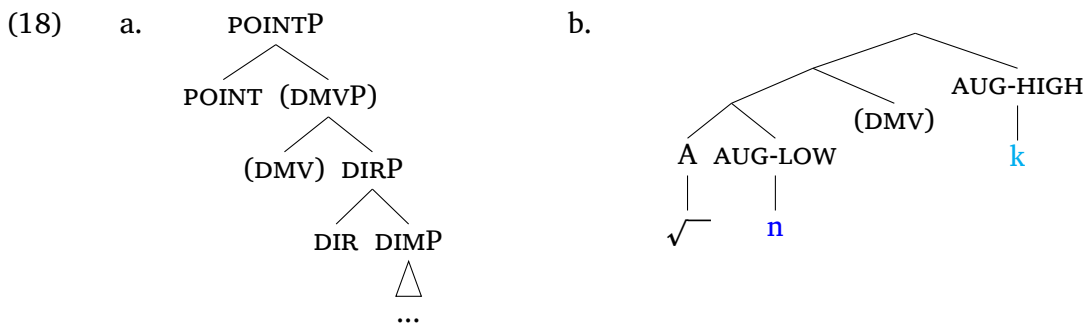

In what follows, we will provide an account of Czech diminutive adjectives that takes as its starting point the idea that the two different augments realise different positions in the structure (18a); namely, *k* will be treated as realising POINT, while *n* will be located below the DMV head in DIR. However, we shall also argue there are reasons to assume that there is no one-to-one relation between syntactic heads and visible morphemes, a conclusion which the tree in (18b) might give rise to. We address these reasons in the next section.

<sup>1</sup>For the sake of simplicity, we shall ignore the optional NEG head in our further discussion.

## 5 Augment distribution as a function of root size

The basic idea we wish to pursue in our analysis presupposes that a single morpheme may pronounce more than one syntactic head. This is the idea of phrasal lexicalisation, which sets nanosyntax apart from other theories. It leads to a powerful explanation for the distribution of morphemes and allomorphs in terms of root size: given that morphemes may be lexically associated to structured sets of features, they can differ in terms of how many such features they contain, i.e., their size. More specifically, we shall argue that the three classes of adjectives that we distinguished in the first section correspond to three different root sizes. This difference in size provides a straightforward explanation for the distribution of the augments.

The first class of adjectives is comprised of those that take no augment, like *tich-y* ‘silent.’ We analyse such roots as being lexically associated to all the features of the positive degree. Such roots can, therefore, pronounce the entire structure of the decomposed adjective, as shown in (19a). On this analysis, adjectives that take *k*, like *leh-k-y* ‘light,’ are only associated to DIM and DIR, and they, therefore, need the augment to pronounce the POINT head, as shown in (19b).

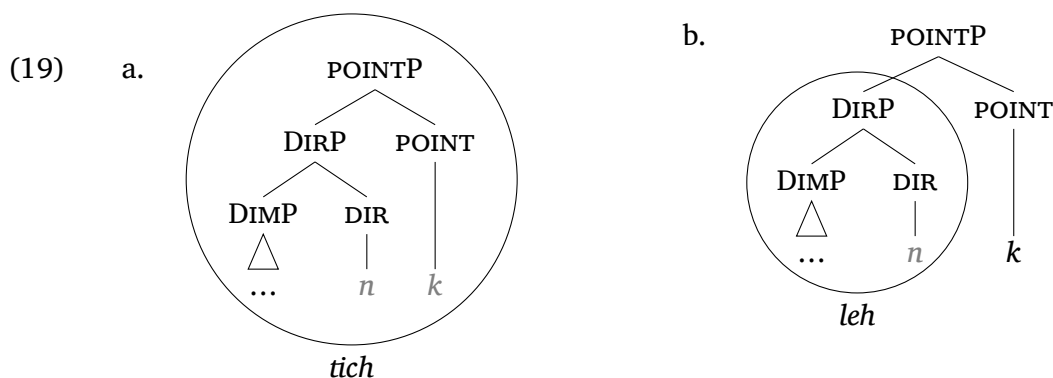

The adjectives that take *n*, like *jem-n-y* ‘smooth’ are smaller still, and can only pronounce DIMP. However, if morphemes attached under terminals, we would expect both *k* and *n* to show up with such adjectives, as shown in (20a). However, the facts are different, and *k* does not normally show up with the *n*-adjectives (except when there is a diminutive). We therefore assume that, like the root, *n* also pronounces multiple terminals, namely DIR and POINT, as informally indicated in (20b). We develop a more formal analysis of this augment in the following section.

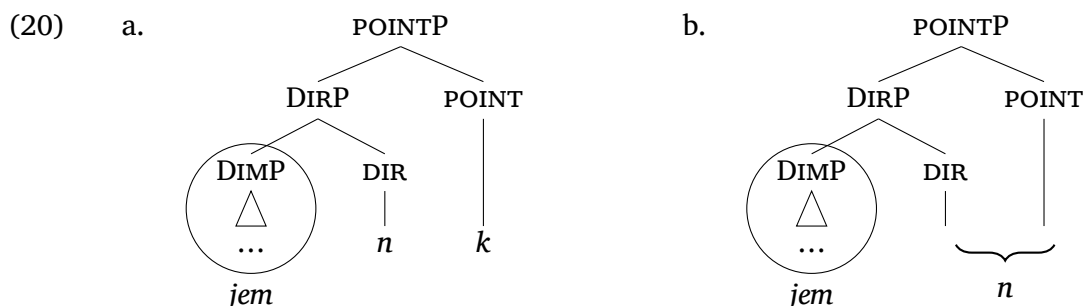

Table 6 represents these three classes in the form of a lexicalisation table. The top row lists the semantic ingredients, and the rows below show which morpheme lexicalises these ingredients in the different adjectival classes. Each adjective has two lines: the first line represents the regular adjective (without the diminutive), with the column of the

DMV marked in black to indicate its absence. From top to bottom, root size decreases, meaning that more and more ingredients must be lexicalised by the augments.

Table 6: Lexicalisation table for three classes of adjectives

DIM	DIR	(DMV)	POINT	gloss
tich				'silent'
tich		ouč	k	'silent'
leh			k	'light'
leh		ouč	k	'light'
jem	n			'smooth'
jem	n	ouč	k	'smooth'

In the case of a root like *tich*, the root is lexically associated to three heads: DIM, DIR, and POINT. This root therefore lexicalises all the ingredients of the positive, as indicated by the shading on the first row. When DMV is present, the root is blocked from realising its full lexicalisation potential. Since the lexical entry for the root is not specified for DMV, it cannot realise it. A separate morpheme *ouč* is therefore needed to pronounce DMV. A second consequence of the presence of DMV is that the root cannot extend up to POINT, and *k* must appear following *ouč* in order to lexicalise POINT. A similar reasoning holds for the augment *n*, which appears with the smallest roots, like *jem*, at the bottom of the table. Without DMV, the augment *n* can lexicalise both DIR and POINT, but in the presence of DMV, an intervention effect arises and *k* is needed to lexicalise POINT.

## 6 Diminutives class-by-class

The lexicalisation tables presented in the previous section are not a primitive of the Nanosyntactic theory, but represent the output of a lexicalisation process that is governed by the so-called Lexicalisation Algorithm. We will now become a little more technical and present, for each adjective class, trees and derivations for both the positive degree and the diminutive adjective. We start out with the POINTP class of adjectives, to which we assign a lexical entry as in (21). The lexical entry represents a link between a syntactic representation (on the left) and a phonological representation (on the right). When syntax produces a structure like the one on the left, it can be linked to the phonology *tich*.

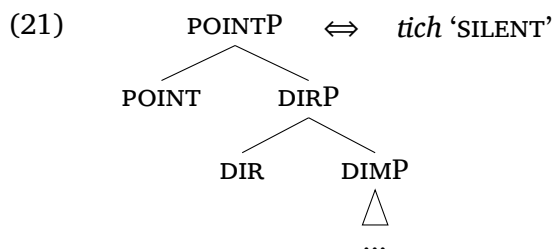

The syntax merges heads from the bottom up, and after each merge step, the lexicon is consulted for a matching constituent to lexicalise the syntactic structure. This is subject to the Matching Condition in (22).

(22) *Matching Condition*

A syntactic phrase *S* matches a lexically stored constituent *L* iff *S* is identical to *L*.

For example, when the syntax adds *DIR* to *DIMP*, creating *DIRP*, it will find an identical constituent *DIRP* inside the lexical entry of the root *tich* in (21). As a result, the root can lexicalise a syntactic structure of the size *DIRP* even when the syntactic structure is smaller than that of the entire lexical entry. The Matching Condition thus derives the Superset Effect, meaning that a lexical entry can lexicalise any phrase that it contains (Starke 2009). After successful lexicalisation of *DIRP*, the syntax will proceed to merge the next head, *POINT*, leading to the lexicalisation of *POINTP* by the same root again, recall (19a), overriding the earlier lexicalisation.

Now if after the creation and lexicalisation of *DIRP*, the syntax merges *DMV* to create a diminutive adjective, we get (23):

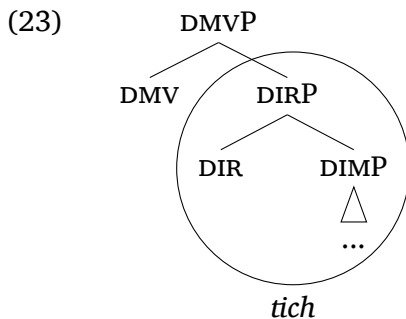

In this case, there is no constituent identical to *DMVP* in the lexicon. What the lexicon does contain are entries for the diminutive suffix (24a), as well as an entry for the augment *k* (24b).

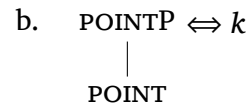
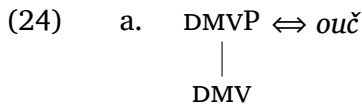

The *DMVP* constituents in (24a) and (23) are not identical, but they can be made so. In general, when a syntactic constituent cannot be matched to one in the lexicon, the syntax will apply one of a series of rescue operations. In this case, the complement of *DMV* (*DIRP*) is moved, creating (25a). Here *DIRP* has moved out of *DMVP*, leaving no trace behind, just a *DMVP* with a single daughter:

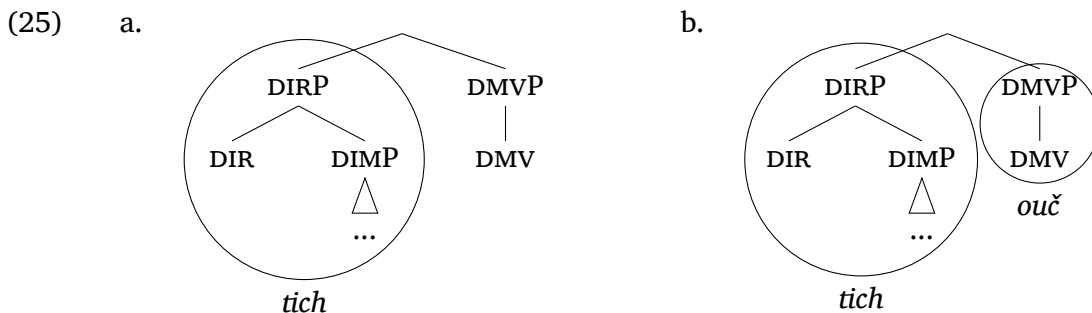

The right branch of (25a) now finds a match in the lexical entry for the suffix in (24a), so that lexicalisation is successful (*tich-ou\check{c}*), see (25b). The same procedure applies when *POINT* is merged, as in (26a). Since there is no direct match in the lexicon for (26a), its

complement moves, creating (26b), where the remnant POINTP finds a match in (24b).

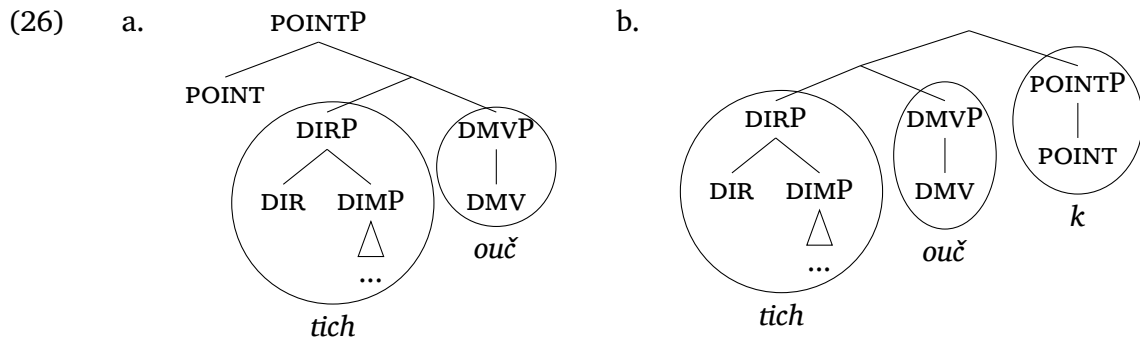

In this manner, after the addition of the agreement, the attested diminutive adjective *tich-ouč-k-ý* ‘silent’ is derived.

The next class of adjectives is the one which takes a *k*-augment, like *leh-k-ý* ‘light’. They have a smaller root size, as shown in (27).

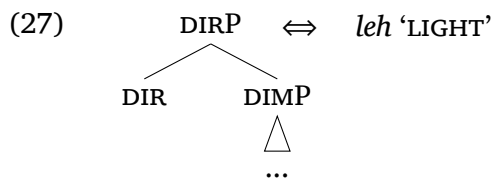

These roots can lexicalise the structure up to DIRP, but at the merger of POINT, they are no longer a match for the syntactic structure, triggering movement of the complement of POINT. This will create a right branch that is a match for the augment *k*. The final result is as in (28):

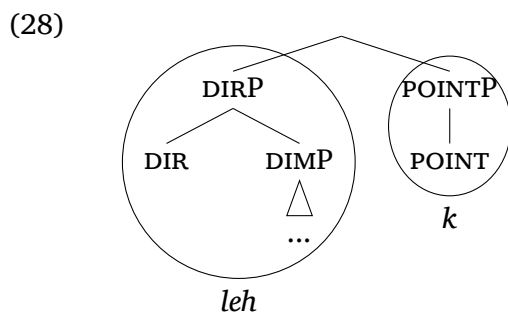

The derivation of the diminutive adjective proceeds in the same manner as for the adjectives of the first class: the root first grows to DIRP size, but then movement is triggered as the root is unable to lexicalise DMV; the same then happens for POINT, which is lexicalised by *k*. The final result is identical to the one in (26b) above, but with the root *tich* replaced by *leh*.

Finally, we consider the roots of the *jem-n-ý* ‘smooth’ class. They are of size DIMP, as shown in (29a), and they take the *n*-augment. As we saw earlier, *n* lexicalises two heads, DIR and POINT. The corresponding lexical entry is given in (29b).

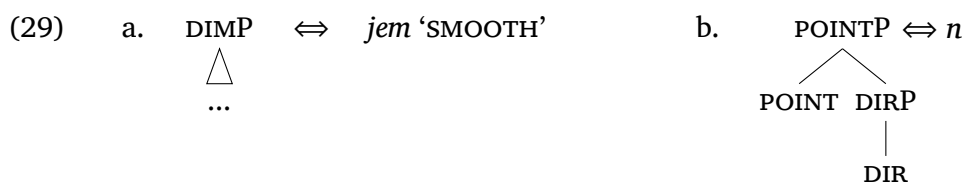

At the point where DIR is merged, see (30a), movement of the complement of DIR will be triggered, as the root is unable to lexicalise DIRP. This creates a remnant right branch DIRP, see (30b), which is a match for a constituent in (29b), so that the right branch may be lexicalised as *n*:



The next step in the derivation is that POINT is merged.

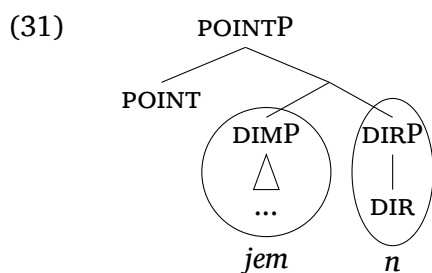

Up until now, all our movement operations have involved the movement of the complement of the newly merged head. But now we need to move a lower constituent, the spec of the complement. Applying spec movement of DIMP will create the structure in (32a), where the right branch is a perfect match for (29b). The right branch will therefore be lexicalised by *n*, as shown in (32b).

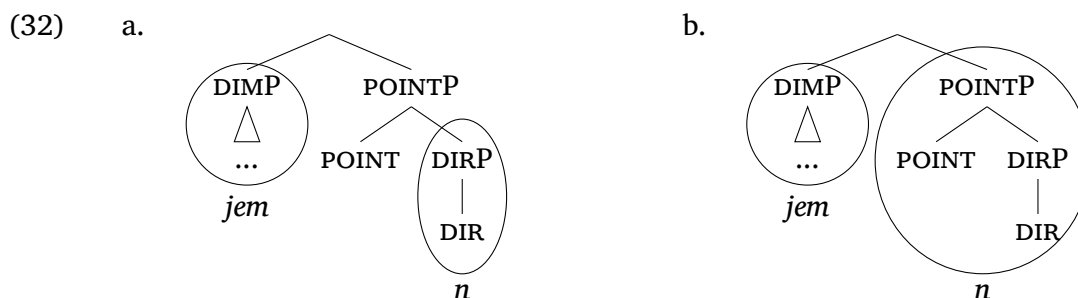

There are, in other words, two types of rescue movement: movement of the complement and movement of the spec of the complement. The choice between the two is not random, but determined by the Lexicalisation Algorithm, which states that spec-movement is always tried before complement movement (Starke 2018).<sup>2</sup>

<sup>2</sup>In the previous discussion, we have, for the sake of simplicity, ignored a step of spec-movement in the derivation of the diminutive adjective *tich-ouč-k-ý*, between the steps (25a) and (26b) in the derivation. Since

In the derivation of the diminutive adjective, DMV will be merged with the derivation after it has reached the point depicted in (30b). This results in (33).

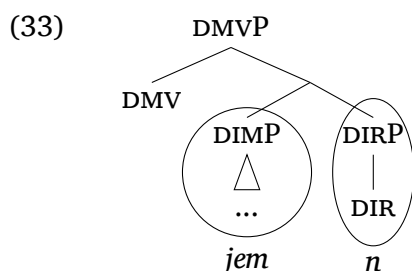

Raising the spec of the complement of DMV will fail to produce a lexicalisation for DMV, since there is no lexical entry consisting of DMV and DIR. When spec-of-complement movement fails, the next movement that is tried is the (pied-piping) movement of the constituent directly dominating the initial target of the movement. This is the complement of DMV, which leads to a successful lexicalisation of DMVP by *ouč*. The next step in the derivation merges POINT, which again can only be lexicalised once its complement has undergone (pied-piping) movement. The result is shown in (34).

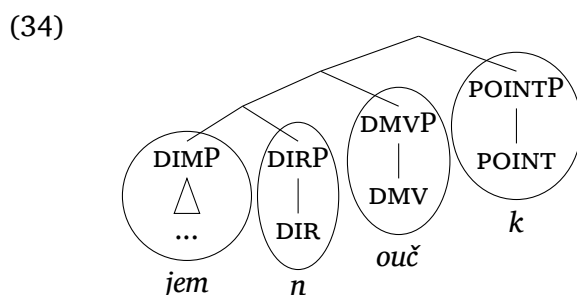

Summarising the results of this section, we have seen that gradable adjectives have a rich internal structure. We have combined this structure with the idea that the three classes of adjectives are lexically associated to structures of different sizes. This difference in root size was shown to account for the distribution of the augments, both with and without the diminutive suffix. While selection of the augment is ‘arbitrary,’ i.e. unpredictable on the basis of any independent property of the root, the analysis we have developed does not need any arbitrary diacritic or feature on the root to get it to take the correct augment.

## 7 The comparative

So far, we have restricted our attention to the distribution of the augments in the positive. Widening the perspective to include the comparative, we see that the augments have a complex distribution, shown in Table 7. As the table shows, the number of classes doubles from three in the positive to six in the comparative, numbered I-VI in the table. The six main classes are differentiated by the pairing of the augments (*n* vs. *k* vs.  $\emptyset$ ) in the positive and in the comparative.

---

in that case spec-movement is unsuccessful, it is undone, and complement movement applies, as depicted in (26b).

Table 7: Augment distribution in the positive and the comparative

		POS	CMPR	
Class I		jem- <b>n</b> -ý	jem- <b>n-ěj-š</b> -í	‘smooth’
Class II		leh- <b>k</b> -ý	leh- <b>k</b> -š-í	‘light’
Class III		žádouc- í	žádouc- <b>n-ěj-š</b> -í	‘desirable’
Class IV	a.	chab- ý	chab- <b>ej-š</b> -í	‘weak’
	b.	slab- ý	slab- š-í	‘weak’
Class V	a.	pozd- <b>n</b> -í	pozd- - <b>ěj-š</b> -í	‘late’
	b.	snad- <b>n</b> -ý	snaz- š-í	‘easy’
Class VI	a.	brz- <b>k</b> -ý	dřív- <b>ěj-š</b> -í	‘early’
	b.	slad- <b>k</b> -ý	slad- š-í	‘sweet’

Some of the classes have two further subclasses (a and b). The subclasses are based on the behaviour of the comparative marker (marked in bold), which shows an alternation between *ějš* and *š*. Following Caha (2017), Caha et al. (2019), we analyse *ějš* as consisting of two morphemes (*ěj* and *š*).

Focusing on the augments for now (and disregarding the subclasses), the six main classes are shown in Table 8. It is clear that this pattern of data presents quite a challenge for any kind of theory, since the presence/absence of a particular augment is not only sensitive to the arbitrary lexical class of the root, but with an arbitrary subset of the *n/k* class roots, the presence of the augment is also sensitive to the degree of the adjective.

Table 8: Six classes of adjectives

	POS	CMPR
I	<b>n</b>	<b>n</b>
II	<b>k</b>	<b>k</b>
III	∅	<b>n</b>
IV	∅	∅
V	<b>n</b>	∅
VI	<b>k</b>	∅

The analysis we are about to propose relies on a decomposition of the comparative into three heads. This decomposition is motivated by the existence of Class III, where a root is followed by three morphemes in the comparative, even though it has no augment in the positive, as shown in (35):

- (35) *žádouc-í* ~ *žádouc-n-ěj-š-í*  
 desirable-AGR desirable-AUG-CMPR-CMPR-AGR  
 ‘desirable ~ more desirable’

This suggests the need for three functional heads to come on top of the positive to derive the comparative. We shall call these heads C0, C1, and C2, as shown in (36).



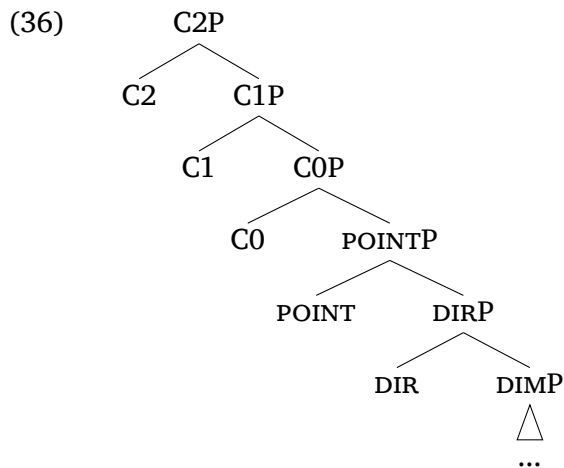

In this section, we show that the classes I-IV can be accounted for quite simply and elegantly in terms of root size. The lexicalisation Table 9 summarises the analysis. The classes are numbered according to root size, with the Class I roots being the smallest ones (DIMP), Class II corresponding to DIRP, Class III corresponding to POINTP and the Class IVa,b with roots of the size COP and C1P respectively. Each class contains a line for the positive (with the features for the comparative marked in black), and one for the comparative.

Table 9: Lexicalisation table for the positive and the comparative (Classes I-IV)

	DIM	DIR	POINT	C0	C1	C2	gloss
I	jem		n				'smooth'
	jem		n		ěj	š	
II	leh		k				'light'
	leh		k			š	
III	žadouc	*					'desirable'
	žadouc		n		ěj	š	
IV a		chab					'weak'
		chab			ěj	š	
b		slab					'weak'
		slab				š	

The classes I and II are familiar from the previous section, and they do not require much further comment. We only need to slightly modify an assumption we made earlier about the lexical entries for *n* and *k*. Whereas we assumed earlier that their top feature was POINT, a consideration of the comparative forms suggests that this assumption cannot be quite correct. This is because the Classes I and II show different behaviour in the comparative, with the *n*-augment followed by *ěj-š* in Class I, and the *k*-augment followed only by *š* in Class II. We can simply account for this by assuming that *n* also lexicalises C0 (on top of DIR and POINT), and *k* C0 and C1 (in addition to POINT). The updated lexical entries that do this are given in (37).

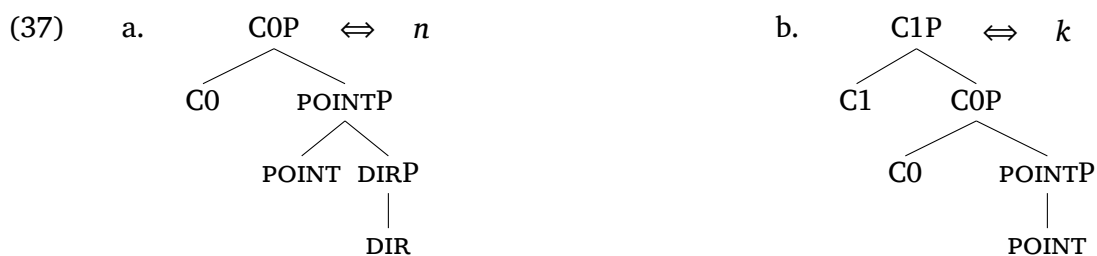

Since the comparative derivations essentially repeat the same steps as in the positive, we shall not go through them here for reasons of space. What we do want to point out, however, is that the classes that have an augment in the comparative have the choice of the comparative allomorph determined by the augment: whereas  $n$  is invariably followed by  $\check{e}j\text{-}\check{s}$ ,  $k$  always takes  $\check{s}$ . This follows from the size of the augments, with  $n$  terminating at C0, and  $k$  at C1.

In contrast, Class IV, which has no augment in the comparative, shows two subclasses, depending on the way the comparative is marked ( $\check{s}$  or  $\check{e}j\check{s}$ ). This is exactly what we expect: as argued in Caha et al. (2019), the choice of the comparative allomorph is determined by root size, but this can only happen when the root is big enough to reach into the comparative layers without needing an augment, as is the case in Class IV depicted in Table 9. When an augment intervenes (as in Classes I-III), the augment determines the choice of the comparative allomorph.

The Class III and Class IV roots are indistinguishable in the positive, in so far as neither takes an augment, which suggests they are at least of the size POINTP. The classes differ in the comparative. In Class III, the root is exactly of size POINTP, so in order to lexicalise C0, the augment  $n$  is needed. The precise division of labor between the root and the augment in the comparative, as well as the issue why  $k$  is not selected to lexicalise C0 is an issue that we shall discuss in greater detail in the next section. The Class IV roots are of size COP (Class IVa) or C1P (Class IVb). They involve a monotonously growing root, and two suffixes to lexicalise C1 ( $\check{e}j$ ) and C2 ( $\check{s}$ ) in the case of Class IVa, or just one suffix  $\check{s}$ , lexicalising C2 (Class IVb). Again, the derivations do not introduce anything new over and above what we have discussed in the previous section, so that we shall refrain from going through them here.

In sum, the Classes I-IV can be accounted for by assuming that they correspond to different root sizes. The smaller a root is, the more suffixes it needs to mark the comparative. Conversely, as the root gets bigger, fewer suffixes are needed.

## 8 Complex trees

We now turn to the Classes V and VI, which feature an augment in the positive but lose it in the comparative. The interesting aspect of these adjectives is that they contradict the tentative universal put forth by Grano & Davis (2018: 133):

- (38) *Candidate Universal*  
 Universally, the comparative form of a gradable adjective is derived from or identical to its positive form.

As such, they also pose a challenge for the analysis in terms of root size that we developed in the previous section. However, we argue that once lexical items with complex left

branches are adopted, the data can be accounted for. A summary of the data (and the analysis) is given in Table 10.

Table 10: Lexicalisation table for the positive and the comparative (Classes V-VI)

		DIM	DIR	POINT	C0	C1	C2	gloss
V	a	pozd		n				'late'
		pozd	*	*	ěj	š		
	b	snad		n				'easy'
		snaz	*	*			š	
VI	a	brz		k				'early'
		dřív		*	ěj	š		
	b	níz		k				'low'
		níz		*	*		š	

The challenge posed by the adjectives in these classes is that they have an augment in the positive, but lose it in the comparative. The former fact suggests that the roots are smaller than the structure of the positive, whence the need for an augment. But this is in contradiction with the fact that the augment is lost in the comparative, a fact which up until now we have attributed to the lexical entry of the root being big enough to lexicalise COP. For example, the Class Va adjective *pozd-n-í* ‘late’ has the *n* augment in the positive, suggesting that it is of size DIMP, but then we would expect the comparative to be *\*pozd-n-ěj-š-í*, whereas the correct form is *pozd-ěj-š-í*, without an augment.

The solution to this conundrum comes from assuming that roots which are identical in size may be different in shape, an idea which has been explored in the work of Blix (2021, 2022). To illustrate the concept, consider the lexical entries in (39).

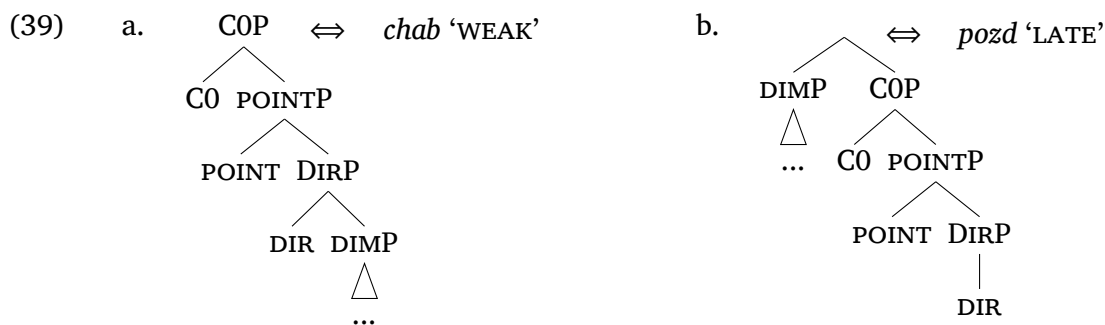

In terms of size, both trees are identical, i.e. they realise exactly the same features, from the bottom of the hierarchy up to COP. But the trees differ in the structural arrangement of the features. In (39a) we have a classical uniformly right-branching tree, and it represents a plain Class IVa root. As we have seen in section 5, this root takes no augment in the positive, nor in the comparative, and this fact follows directly from its size (COP). The Class Va root in (39b), on the other hand, has a tree that has the DIMP constituent not sitting at the bottom, but in a raised position, at the top of the tree. This tree can lexicalise DIMP, since it contains it as a subconstituent. It can also lexicalise COP, as we shall see immediately when we go through the steps of the derivation. However, it will not be able to directly lexicalise the sequence of constituents created by merging the heads between DIM and C0, to wit DIRP and POINTP. This is the meaning of the asterisks in Table 10: they indicate constituents, like DIRP and POINTP, which the root cannot

lexicalise because of the shape of its lexical entry.

Let us now see how this works in greater detail. After DIMP is created, the syntax merges DIR, creating a constituent [<sub>DIRP</sub> DIR [<sub>DIMP</sub> [ ... ]]]. Now this constituent is not contained in (39b) as a constituent, and therefore (39b) cannot directly lexicalise the structure. As a result, movement of DIMP is triggered, creating a remnant constituent [<sub>DIRP</sub> DIR ], which will be lexicalised by the augment *n*. This means that, already at an early stage in the derivation, due to the shape of the lexical entry, the augment makes its appearance, despite the fact that the root is of size COP. When subsequently POINT is merged, movement will target the spec of the complement, and the augment will lexicalise POINT, thus deriving the attested form of the positive *pozd-n* ‘late’ (ignoring agreement). Its structure is shown in (40).

(40)

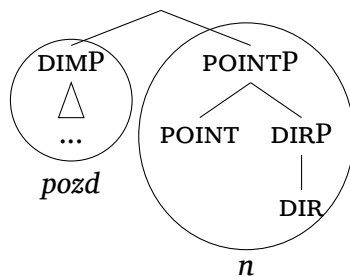

If the derivation continues to derive a comparative, C0 will be merged. Since this will not give rise to a direct lexicalisation, once again movement is triggered. This movement targets DIMP, and moves it leftward. The structure so created is an exact match for (39b), causing the single root *pozd* to override the earlier augmented lexicalisation *pozd-n*. This is shown in (41).

(41)

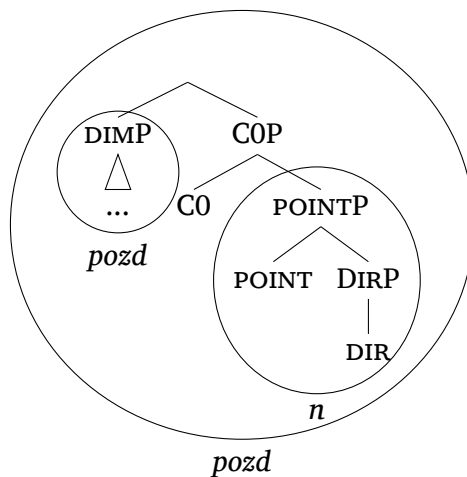

The subsequent steps in the derivation keep this structure ultimately intact, leading to the attested pattern where the root (lexicalised as in (41)) is directly followed by the comparative markers *ěj-š*. How this works is that, after the merger of C1, initially DIMP will be targeted for movement, but since this is unsuccessful, it will pied-pipe its mother node, i.e. the entire tree in (41). The remnant constituent [<sub>C1P</sub> C1 ] will be lexicalised by the suffix *ěj*. The same steps will be repeated for C2, which will lexicalise as *š*, leading to the attested *pozd-ěj-š-í* ‘later’.

The Class Vb roots have a lexical entry as in (42):

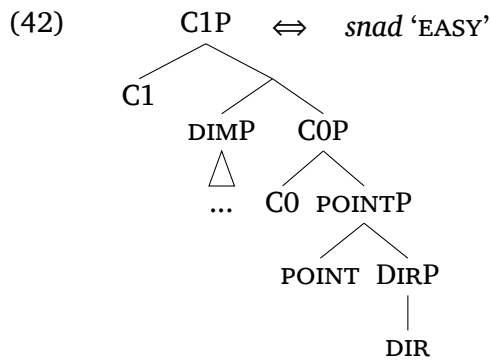

Note that the constituent that is the sister of C1 in (42) is identical to that of the Class Va roots, which we just discussed. This means that the derivation will proceed identically as for the Class Va roots, up to the COP stage. The root can lexicalise the syntactic structure that corresponds to the unlabelled node dominating COP, since it is a subpart of (42). The difference with the Class Va roots is that, after the root lexicalises COP (as in (41)), C1 is merged, and will be directly lexicalisable by (42). The root has now reached its maximal lexicalisation potential (C1P). After that, C2 will be merged, and movement will initially target DIMP, but unsuccessfully so, triggering pied-piping movement of the entire C1P, and lexicalisation of the remnant [<sub>C2P</sub> C2 ] by š, creating *snaz-š-í* ‘easier’.

The Class VI roots work analogously. We give the lexical entries for a Class VIa root in (43a), and a Class VIb root in (43b).

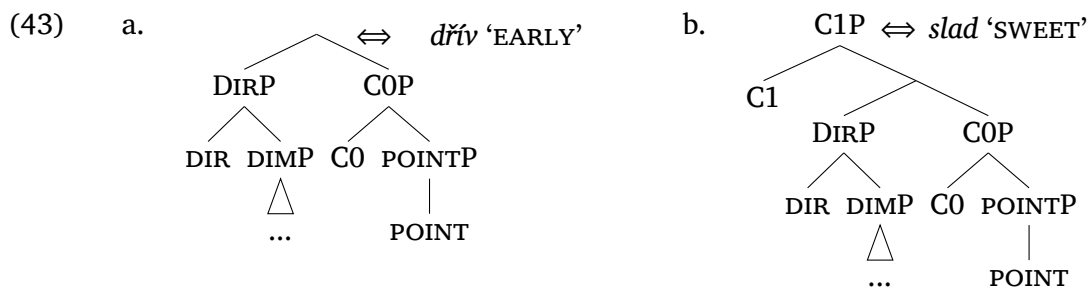

The difference with the previous class is the size of the left branch: in Class V roots it was DIMP, but here it is DIRP. This means that the root will initially be able to lexicalise directly until the DIRP stage, and movement will only be triggered at the merger of POINT. Since this will create a remnant constituent [<sub>POINTP</sub> POINT], the augment will be *k* rather than *n* (since *k* has POINT as its lowest feature). Table 10 shows the difference between the classes V and VI in the placement of the asterisks, which, reading from left to right, start appearing at the point where the left branch stops.

Other than that, the derivations of the two classes are largely identical, with the difference in root size between (43a) and (43b) accounting for the different patterns of comparative marking between the VIa and the VIb class.

As a final point in this section, we need to return briefly to the Class III roots, which take no augment in the positive, and take *n* in the comparative (e.g. *žádouc-í—žádouc-n-ěj-š-í* ‘(more) desirable’). Here the question arises why it is exactly the augment *n* that is required in the comparative, rather than *k*. To derive this, we again assume a lexical entry with a complex left branch, as shown in (44).

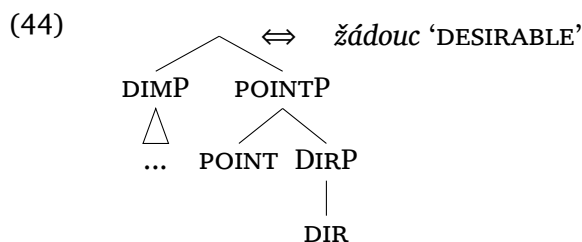

The fact that *n* is selected rather than *k* follows from the size of the left branch (DIMP), as explained above. This type of lexical entry will trigger the presence of the augment *n* already in a very early stage of the derivation, after the merger of DIR and the movement of DIMP, yielding *žádouc-n*. When POINT is subsequently merged and DIMP moves up further, the augmented root *žádouc-n* will be overridden by the plain root, because at that point the structure created is an exact match for (44) (see the discussion of *pozd-ěj-š-í* 'later' in (41) above).

Now when C0 is merged, no direct lexicalisation is possible, and again DIMP will be the target of movement. This movement destroys the configuration that matched (44), and with it, its lexicalisation by the root. However, it does lead to a successful lexicalisation of C0 by the augment, as shown in (45).

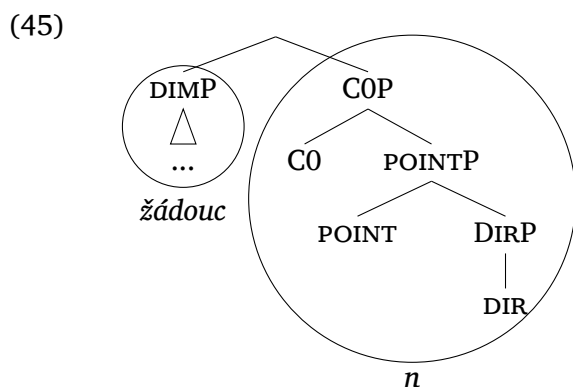

The further steps in the derivation involve the merger of C1 and C2, and their lexicalisation by *ěj* and *š*, in the usual way.

In sum, this section has shown that the intricate distributional patterns of augments and comparative markers of Table 7 above is fully accounted for by our theory, making only minimal assumptions. These involve assigning a rich internal structure to gradable adjectives, both in the positive and the comparative, the idea of phrasal lexicalisation, and the existence of lexical entries with complex left branches.

## 9 Conclusion

We started out this paper by observing that Czech adjectives have three ways of marking the positive degree: zero, *k*, and *n*. The combination with the diminutive suffix revealed that the augments occupy different structural positions, since *n* precedes, but *k* follows, the diminutive. We then decomposed the positive into three components: DIM, DIR, and POINT. We developed a theory of root size, which explains the distribution of zero, *k*, and *n*, as well as the fact that the diminutive suffix is always followed by *k*, regardless of the class the adjective belongs to. We next considered the formation of the comparative, and saw the number of classes increase from three to six, merely on the basis of augment

distribution. Considering the allomorphy of the comparative marker added another three (sub)classes. Of the six main classes, four were amenable to a simple analysis in terms of root size alone. The two remaining classes illustrated the need for root shape, in addition to root size, as a determining factor in augment distribution.

## 10 Acknowledgements

For useful comments and feedback, we thank the audiences at the 2023 DegP workshop in Leuven and the 2023 Olinco conference in Olomouc.

## References

- Blevins, James P. 2016. *Word and paradigm morphology*. Oxford University Press.
- Blix, Hagen. 2021. Spans in South Caucasian agreement: Revisiting the pieces of inflection. *Natural Language & Linguistic Theory* 39. 1–55.
- Blix, Hagen. 2022. Interface legibility and nominal classification: A Nanosyntactic account of Kipisigis singulatives. *Glossa: A Journal of General Linguistics* 1. 132.
- Caha, Pavel. 2017. Explaining Bobaljik’s root suppletion generalization as an instance of the adjacency condition (and beyond). In Joseph Emonds & Markéta Janebová (eds.), *Language use and linguistic structure: Proceedings of the Olomouc linguistics colloquium 2016*. 193–208. Olomouc: Palacký university.
- Caha, Pavel, Karen De Clercq & Guido Vanden Wyngaerd. 2019. The fine structure of the comparative. *Studia Linguistica* 73(3). 470–521. doi:<https://doi.org/10.1111/stul.12107>.
- Cresswell, Max. 1976. The semantics of degree. In Barbara Partee (ed.), *Montague grammar*. 261–292. New York: Academic Press.
- De Clercq, Karen & Guido Vanden Wyngaerd. 2019. Negation and the functional sequence. *Natural Language & Linguistic Theory* 37(2). 425–460.
- Grano, Thomas & Stuart Davis. 2018. Universal markedness in gradable adjectives revisited. The morpho-semantics of the positive form in Arabic. *Natural Language & Linguistic Theory* 36(1). 131–147.
- Kennedy, Christopher. 2001. On the monotonicity of polar adjectives. In Jack Hoeksema, Hotze Rullman, Victor Sanchez-Valencia & Ton van der Wouden (eds.), *Perspectives on negation and polarity items*. 201–221. Amsterdam: John Benjamins.
- Starke, Michal. 2009. Nanosyntax: A short primer to a new approach to language. *Nordlyd* 36. 1–6.
- Starke, Michal. 2018. Complex left branches, spellout, and prefixes. In Lena Baunaz, Karen De Clercq, Liliane Haegeman & Eric Lander (eds.), *Exploring nanosyntax*. 239–249. Oxford: Oxford University Press.
- Vanden Wyngaerd, Guido, Michal Starke, Karen De Clercq & Pavel Caha. 2020. How to be positive. *Glossa* 5(1). 23. 1–34.